

# We Know the value of life

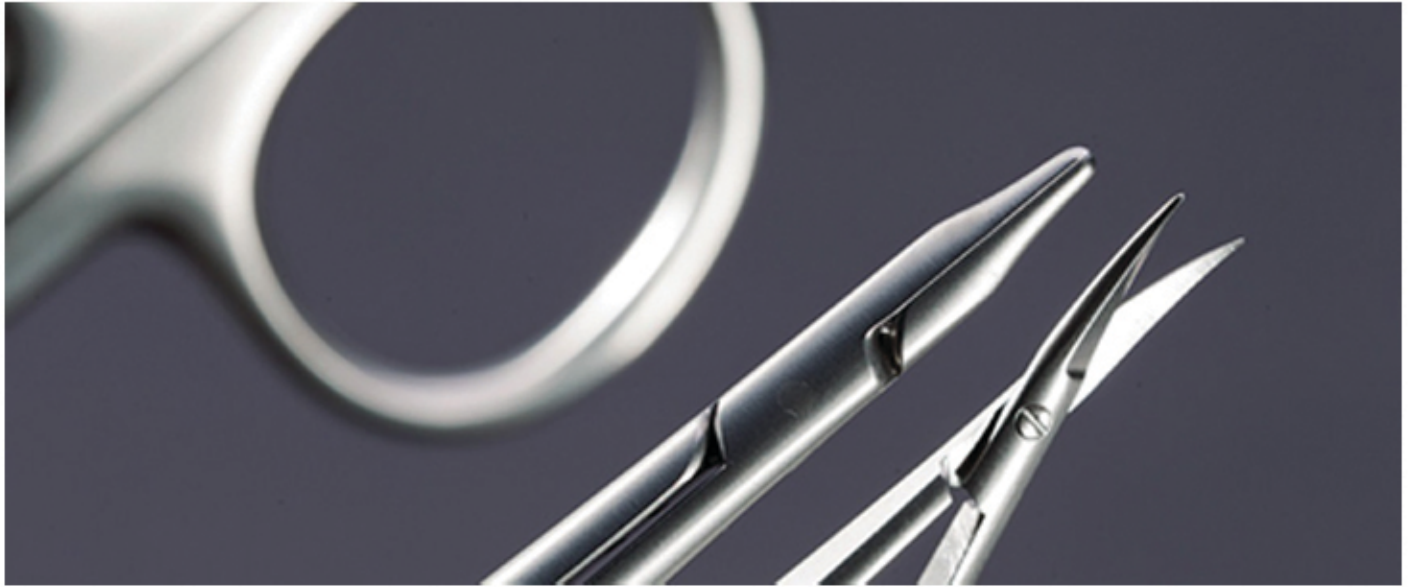

Anesthesia  
Cardiovascular / Thoracic  
Ear, Nose & Throat  
General Surgery  
Multi-Disciplinary Instruments  
Neurosurgery  
Obstetrics & Gynecology  
Ophthalmology  
Orthopaedic Surgery  
Urology  
Orthopaedics and Traumatology  
Plastic Surgery

SURGICAL

ISO 13485  
ISO 9001  
CE

 Thempson

## Page 1 To 19



Head Mirrors	1-3
Head Bands & Lights	3, 4
Stethoscopes	5-8
Accessories for Stethoscopes	9
Measuring Instruments	10
Aesthesiometers	11
Diagnostic sets	12-14
Anaesthesia Masks	15
Percussion Hammers	16-19

## Page 87 To 103



Scissors With Tungsten Carbide Inserts	87-103
--	--------

## Page 20 To 43



Scalpel Handles	20-23
Razor Blade Holder & Breakers	24
Operating Scalpels	25-32
Dura & Fistula Knives	32, 33
Abscess & Cone Knives	34, 35
Post Mortem Knives	36-40
Amputation Knives	41, 42
Razors	42
Skin Grafting Knives	43

## Page 104 To 115



Bandage Scissors	104-107
Cloth Scissors	108
Plaster Shears	109-111
Plaster Breakers	112
Plaster Spreaders	113
Plaster Knives	114
Plaster Lifter	115
Plaster Trepine	115
Plaster Saws	115

## Page 44 To 86



Delicate Scissors	44-52
Ligature Scissors	53, 55
Operating Scissors	56-64
Dissecting Scissors	65-71
Vascular Scissors	72-77
Neurosurgical Scissors	78
Tonsil & Nasal Scissors	79, 80
Gynecological Scissors	81-85
Episiotomy Scissors	85
Umbilical & Gum Scissors	86

## Page 116 To 119



Amputation Saws	116-119
Wire Saws	119

## Page 120 To 127



Nail Nippers	120, 121
Cuticle Nippers	122
Nail Knives	123
Nail Spatulas	124, 125
Nail Excavators & Files	125
Nail Scissors	126, 127
Cuticle Scissors	127

## Page 161 To 228



Haemostatic Forceps	161-178
Tissue & Organ Forceps	179, 180
Dissecting & Ligature Forceps	181-186
Bronchus & Gall Duct Clamps	187-189
Kidney Pedicle Clamps	190, 191
Hysterectomy Forceps	192-196
Vaginal Forceps	197-200
Atrauma Forceps	201-203
Peritoneal Clamp Forceps	204-206
Bulldog & Tubing Clamps	207-210
Towel Forceps	211-214
Dressing Forceps	215-228

## Page 128 To 157



Dressing & Tissue Forceps	129-143
Splinter Forceps	144-147
Cilia Forceps	148-150
Special Forceps	151-153
Micro Forceps	154-158

## Page 229 To 240



Trocars	229-233
Suction Tubes	234-240

## Page 158 To 160



Dressing & Tissue Forceps With Tungsten Carbide Inserts	159-160
--	---------

## Page 241 To 268



Needle Holders	241-257
Needle Holders With Tungsten Carbide Inserts	258-268

## Page 269 To 275



Micro Needle Holders	269-274
Micro Needle Holders	275
Bayonet Shaped	

## Page 420 To 432



Mallets	420-425
Meniscectomy Knives	426, 427
Meniscectomy &	428
Cartilage Forceps	
Tendon Seizing Instruments	429-432

## Page 276 To 297



Reverdin Needles	276-278
Suture Needles	279-286
Suture Conductors	287-290
Suture Instruments	291-294
Suture & Pocket	295-297
Instruments sets	

## Page 443 To 483



Bone Chisels, Gouges &	433-447
Osteotomes	
Tampers	448
Raspatories	449-460
Bone Elevators	461-463
Bone Levers	463-472
Bone Files	473-475
Bone Curettes	476-483

## Page 298 To 419



Retractors	298-405
Abdominal Retractors	406-414
Bladder Retractors	415-418
Laminectomy Retractors	419

## Page 484 To 519



Bone Cutting Forceps	484-490
Bone Rongeurs	491-502
Bone Holding Forceps	503-515
Bone Holding Clamps	516, 517
Nail Instruments	518, 519



## Page 520 To 555



Rib Shears	520-522
Sternum Instruments & Ret.	523
Rib Spreaders	524-535
Bronchus Forceps	536, 537
Lung Grasping Forceps	537
Hand Drills	538-540
Screw Drivers	541-543
Plate & Screw Holders	544
Extension Bows	545-547
Wire Guides	548
Flat Nose Pliers & Forceps	549-551
Wire Cutting Pliers	552-555

## Page 580 To 598



Laryngeal Mirrors	580, 581
Laryngeal Mirror Handles	580, 581
Laryngeal Polypus Forceps	582, 583
Temporomandibular Inst.	584
Disimpaction Forceps	585
Awls	586
Tonsil Knives	587-589
Ligature Carriers	590
Tonsil Retractors	591
Tonsil Elevators	592
Tonsil Needles	592-594
Tonsil Seizing Forceps	594, 595
Tonsil Haemostats	596
Tonsil Snares	596, 597
Tonsillectomes	598

## Page 556 To 561



Laryngoscope Handles	556, 557
Laryngoscope sets	558-561

## Page 599 To 606



Broncho-Oesophagoscapy	599-604
Forceps	
Broncho-Oesophagoscapy	603
Scissors	
Laryngeal Scissors & Forceps	605, 606

## Page 562 To 579



Mouth Gags	562-569
Tongue Depressors	569-572
Cheek & Lip Retractors	572, 573
Finger Protectors	573
Intra Oral Retractors	574-576
Ramus & Chin Retractor	577
Tongue Holding Forceps	578, 579

## Page 607 To 612



Tracheal Trocars	607
Tracheal Dilators	607
Tracheal Retractors	607-609
Tracheal Tubes	610, 611
Tracheotomy Dilator sets	612

## Page 613 To 653



Nasal Speculum	613-618
Nasal Snare	618
Nasal Polypus Forceps	619-622
Nasal Cutting Forceps	623, 624
Nasal & Septum Knives	625-627
Septum Elevators	627-631
Septum Scissors	632
Rhinoplastic Instruments	633-644
Rhinoplastic Forceps & Sci.	645, 646
Rhinoplastic Hammers	647
Adenoid Curettes	648-652
Catheters & Cannulas	652, 653

## Page 680 To 701



Ear Specula	680-683
Tuning Forks	683-687
Knives	688, 689
Paracentesis Needles	689-692
Needles, Picks & Hooks	693
Dissectors & Elevators	694
Footplate Hand Instruments	695
Curettes & Loops	696, 697
Foreign Body Instruments	698
Hooklets	699
Excavators & Elevators	700
Ear Syringes	701

## Page 654 To 668



Punches	654-662
Kerrison, Hajek, Colclough & Sybert etc.	
Rongeurs	662-668
Cushing, Weil-Blakesley, & Caspar etc.	

## Page 702 To 746



Eye Speculum	702, 703
Lid Everters & Retractors	704
Eye Scalpels & Knives	705-710
Foreign Body Gouges	711
Hooks & Hooklets	712
Ophthalmic Instruments	713-721
Trephines & Burs	722
Chisels, Gouges & Elevators	723
Double Instruments	724
Eye Forceps	725-738
Eye Scissors	738-744
Needles & Eye Op. sets	744-746

## Page 699 To 679



Steinhauser Instruments	699, 670
Ear Polypus Snares	671
Ear Polypus Forceps	672, 673
Micro Ear Forceps	674-676
Micro Ear Scissors	676, 677
Wire Closure Forceps	678
Introduction Instrumens	679
Crura & Malleus Nippers	679

## Page 747 To 764

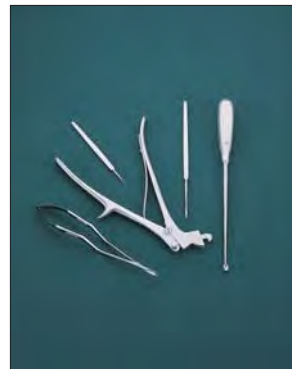

Micro Neuro Scissors	747, 748
Micro Neuro Needle Holders	748
Micro Knives & Hooks	749
Micro Ligature Guides	750
Micro Dissectors & Forceps	751
Micro Scissors	752
Micro Clips & Applying Fcp	753, 754
Cranial Openers	754, 755
Cervical Traction Tongs	755, 756
Dura Dissectors & Hooks	757-760
Pituitary Curettes	760, 761
Knives, Separators & Ret.	762-764

## Page 765 To 766



Lucas Currettes	765
Hooklets	765
Comedo Extractors	766

## Page 856 To 868



Gall Duct Forceps	856, 857
Gall Duct Probes	857
Gall Stone Forceps	858-860
Gall Stone Scoops	860-862
Gall Duct Dilators	862, 863
Kidney Stone Forceps	864
Ureter Calculus & Nephrostomy Forceps	865
Kidney Elevating Forceps	867
Kidney Pedical Forceps	868

## Page 767 To 807



Tissue & Organ Holding Fcp	767-770
Dissecting Forceps	771
Intestinal & Stomach Clamps	772-784
Atrauma Intestinal Clamps	785-789
Atrauma Sigmoid Forceps	790-793
Oesophagus Dissectors	794
Rectal Specula	795-799
Haemorrhoidal Forceps	800, 801
Rectal Scissors	801, 802
Haemorrhoidal Ligators	802, 803
Biopsy Forceps	804-806
Swab Holders	806, 807

## Page 869 To 877

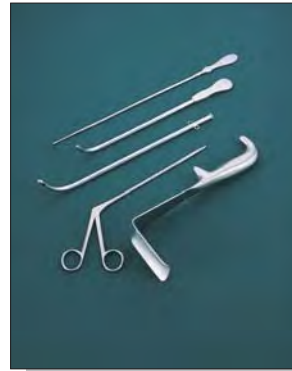

Bladder Retractors	869
Prostatic Retractors	869, 870
Genito-Urinary Instruments	872-877

## Page 808 To 855



Atrauma Bulldog Forceps	808, 809
Atrauma Cardiovascular Fcp	809-837
Neonatal & Pediatric Clamps	838-840
Atrauma Aorta Clamps	841
Atrauma Tissue Forceps	842, 843
Aortic Dilators & Biopome	844, 845
Tunneling Instruments	846
Endarterectomy	847
Vascular Spatulas	848
Aorta Clamps & Retractors	849
Valvulotomes	851
Vessel & Vana Cava Clamps	852-855

## Page 878 To 943



Uterine Tenaculum Forceps	878-887
Uterine Polypus Forceps	888
Uterine Elevating Forceps	889, 890
Uterine Biopsy Forceps	891-898
Myoma & Micro Tubal Inst.	899
Uterine Sounds	900
Cotton & Caustic Holders	901
Uterine Depressor & Dilators	902-906
Biopsy & Uterine Curettes	907-916
Aspiration Curettes	917
Uterine Scoops	918, 919
Vaginal Specula & Ret.	921-943

## Page 943 To 964



Placenta & Ovum Forceps	944-950
Scalp Flap Forceps	951
Ovum Curettes	952
Abortion Scoops	952
Umbilical & Episiotomy Scissors	953
Pelvimeters	954, 955
Cranioclast	956
Basiotribes	957
Obstetric Forceps	958-964

## Page 965 To 989



Sterilizing Forceps	965-968
Tubing Clamps	969
Sterilizing Cases, Racks,	970-975
Trays & Storing Cases	
Sterilizing & Dressing Boxes	976, 977
Sterilizing Jars	977, 978
Containers	979, 980
Irrigators, Jugs & Jars	981
Round Bowls & Dishes	982, 983
Instrument Trays & Boxes	984-986
Kidney Trays & Urinary Pot	987, 988
Cotton Receptacles	989

## Page 1 To 19



Miroirs principaux	1-3
& de bandes principales ; Lumières	3, 4
Stéthoscopes	5-8
Accessoires pour Stéthoscopes	9
Instruments de mesure	10
Aesthesiometers	11
Ensembles de diagnostics	12-14
Masques d'anesthésie	15
Marteaux de percussion	16-19

## Page 87 To 103



Ciseaux avec des insertions de carbure de tungstène	87-103
---	--------

## Page 20 To 43



Poignées de scalpel	20-23
& de porte-scie de rasoir ; Briseurs	24
Scalpels d'opération	25-32
& de Dura ; Couteaux de fistule	32, 33
& d'abcès ; Couteaux de cône	34, 35
Couteaux post mortem	36-40
Couteaux d'amputation	41, 42
Rasoirs	42
Couteaux de greffe de peau	43

## Page 104 To 115



Karbid-Einsätze	104-107
Ciseaux de tissu	108
Cisaillements de plâtre	109-111
Briseurs de plâtre	112
Écarteurs de Plasyer	113
Couteaux de plâtre	114
Poussoir de plâtre	115
Trépan de plâtre	115
Scies de plâtre	115

## Page 44 To 86



Ciseaux sensibles	44-52
Ciseaux de ligature	53, 55
Ciseaux d'opération	56-64
Ciseaux de dissection	65-71
Ciseaux vasculaires	72-77
Ciseaux neurochirurgicaux	78
& d'amygdale ; Ciseaux nasaux	79, 78
Ciseaux gynécologiques	81-85
Ciseaux d'épisiotomie	85
& ombilical ; Ciseaux de gomme	86

## Page 116 To 119



Scies d'amputation	116-119
Scies de fil	119



## Page 120 To 127



Pincés d'ongle	120, 121
Pincés de cuticle	122
Couteaux d'ongle	123
Spatules d'ongle	124, 125
& d'excavatrices d'ongle ; Dossiers	125
Ciseaux d'ongle	126, 127
Ciseaux de cuticle	127

## Page 161 To 228



Forceps hémostatique	161-178
& de tissu ; Forceps d'organe	179, 180
& de dissection ; Forceps de ligature	181-186
& de bronche ; Brides de conduit d'écorchure	187-189
Brides de Pedicale de rein	190, 191
Forceps d'hystérectomie	192-196
Forceps vaginal	197-200
Forceps d'Atrauma	201-203
Forceps péritonéal de bride	204-206
& de Bulldog ; Brides de tuyauterie	207-210
Forceps de serviette	211-214
Habillage du forceps	215-228

## Page 128 To 157



Habillage du & ; Baïonnette de forceps de tissu formée	128-141
Habillage du & ; Angulaire de forceps de tissu formé	142
Forceps d'éclat	143
Forceps de cils	144-147
Forceps spécial	148-150
Forceps micro	151, 152
	154-157

## Page 229 To 240



Trocars	229-233
Tubes d'aspiration	234-240

## Page 158 To 160



Habillage du & ; Forceps de tissu avec des insertions de carbure de tungstène	158-160
---	---------

## Page 241 To 268



Supports d'aiguille	241-257
Supports d'aiguille avec des insertions de carbure de tungstène	258-268

## Page 269 To 275



Supports micro d'aiguille 269-274  
La baïonnette micro de supports d'aiguille a formé 275

## Page 420 To 432



Maillets 420-425  
Couteaux de Meniscectomy 426, 427  
& de Meniscectomy ; Forceps de 428  
cartilage  
Tendon saisissant des instruments 429-432

## Page 276 To 297



Aiguilles de Reverdin 276-278  
Aiguilles de suture 279-286  
Conducteurs de suture 287-290  
Instruments de suture 291-294  
& de suture ; Ensembles d'instruments 295-297  
de poche

## Page 443 To 483



Burins d'os, & de gouges ; 433-447  
Osteotomes  
Bourreurs 448  
Raspatories 449-460  
Ascenseurs d'os 461-463  
Leviers d'os 463-472  
Dossiers d'os 473-475  
Curettes d'os 476-483

## Page 298 To 419



Rétracteurs 298-405  
Rétracteurs abdominaux 406-414  
Rétracteurs de réservoir souple 415-418  
Rétracteurs de Laminectomy 419

## Page 484 To 519



Forceps de découpage d'os 484-490  
Os Rongeurs 491-502  
Forceps de possession d'os 503-515  
Bone Holding Clamps 516, 517  
Instruments d'ongle 518, 519

## Page 520 To 555



& d'instruments de sternum ; Rouiszez.	520-522
Sternum Instruments & Ret.	524-535
Écarteurs de nervure	536, 537
Forceps de bronche	537
Poumon saisissant le forceps	538-540
Exercices de main	541-543
Conducteurs de vis	544
& de plat ; Supports de vis	545-547
Arcs de prolongation	548
Guides de câblage	549-551
& au nez épâté de pinces ; Forceps	552-555

## Page 580 To 598



Miroirs laryngés	580, 581
Poignées laryngées de miroir	580, 581
Forceps laryngé de Polypus	582, 583
Instruments temporo-mandibulaires	584
Forceps de Disimpaction	585
Alènes	586
Couteaux d'amygdale	587-589
Porteurs de ligature	590
Rétracteurs d'amygdale	591
Ascenseurs d'amygdale	592
Aiguilles d'amygdale	592-594
Amygdale saisissant le forceps	594, 595
Amygdale Haemostats	596
Pièges d'amygdale	596, 597
Lectomes d'amygdale	598

## Page 556 To 561



Poignées de Laryngoscope	556, 557
Ensembles de Laryngoscope	558-561

## Page 599 To 606



Forceps de broncho-Oesophagocopy	599-604
Ciseaux de broncho-Oesophagocopy	603
& laryngé de ciseaux ; Forceps	605, 606

## Page 562 To 579



Bâillons de bouche	562-569
Spatules	569-572
& de joue ; Rétracteurs de lèvres	572, 573
Protecteurs de doigt	573
Intra rétracteurs oraux	574-576
& de Ramus ; Rétracteur de menton	577
Forceps de possession de langues	578, 579

## Page 607 To 612



Trocars trachéal	607
Dilateurs trachéaux	607
Rétracteurs trachéaux	607-609
Tubes trachéaux	610, 611
Ensembles de dilateurs de trachéotomie	612

## Page 613 To 653



Spéculum nasal	613-618
Piège nasal	618
Forceps nasal de Polypus	619-622
Forceps nasal de découpage & nasal ; Couteaux de septum	623, 624
Ascenseurs de septum	625-627
Ciseaux de septum	627-631
Instruments de Rhinoplastic	632
& de forceps de Rhinoplastic ; Ciseaux	633-644
Marteaux de Rhinoplastic	645, 646
Curettes adénoïdes	647
& de cathétères ; Canules	648-652
	652, 653

## Page 680 To 701



Spéculums d'oreille	680-683
Diapasons	683-687
Couteaux	688, 689
Aiguilles, & de sélections ; Crochets & de dissecteurs ; Elavators	689-692
Instruments de main de Footplate	693
& de Curettes ; Boucles	694
Instruments de corps étranger	695
Hooklets	696, 697
& d'excavatrices ; Ascenseurs	698
Seringues d'oreille	699
	700
	701

## Page 654 To 668



Poinçons Kerrison, Hajek, & de Colclough ; Sybert etc.	654-662
Rongeurs Cushing, & de Weil-Blakesley ; Caspar etc.	662-668

## Page 702 To 746



Spéculum d'oeil	702, 703
& d'Everters de couvercle ; Rétracteurs	704
& de scalpels d'oeil ; Couteaux	705-710
Gouges de corps étranger	711
& de crochet ; Hooklets	712
Instruments ophtalmiques	713-721
Trépane le & ; Burs	722
Burins, & de gouges ; Ascenseurs	723
Doubles instruments	724
Forceps d'oeil	725-738
Ciseaux d'oeil	738-744
& d'aiguilles ; Oeil op. Ensembles	744-746

## Page 699 To 679

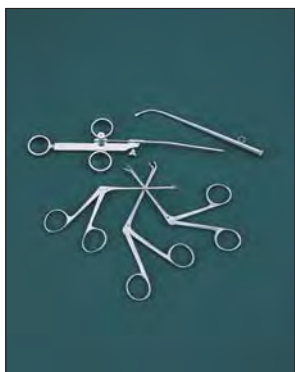

Instruments de Steinhauser	699, 670
Pièges de POLypus d'oreille	671
Forceps de POLypus d'oreille	672, 673
Forceps micro d'oreille	674-676
Ciseaux micro d'oreille	676, 677
Forceps de fermeture de fil	678
Introduction Instrumens	679
& de Crura ; Pincés de Malleus	679

## Page 747 To 764

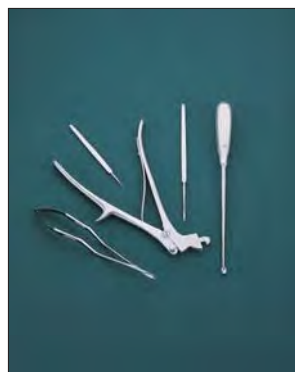

Neuro- ciseaux micro	747, 748
Neuro- supports micro d'aiguille	748
& micro de couteaux ; Crochets	749
Guides micro de ligature	750
& micro de dissecteurs ; Forceps	751
Ciseaux micro	752
Le micro coupe le & ; Application de Forceps	753, 754
Ouvreurs crâniens	754, 755
Ouvreurs crâniens	755, 756
& de dissecteurs de Dura ; Crochets	757-760
Curettes pituitaires	760, 761
Couteaux, & de séparateurs ; Rétracteurs	762-764

## Page 765 To 766

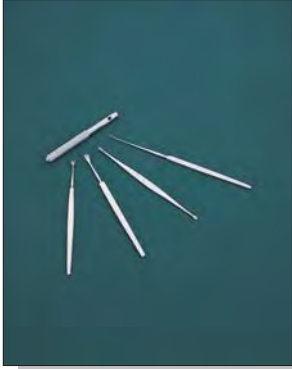

Curettes de Lucas	765
Hooklets	765
Extracteurs de Comedo	766

## Page 856 To 868

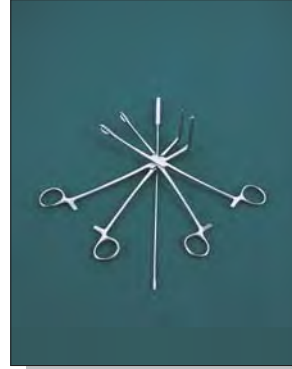

Forceps de conduit d'écorchure	856, 857
Sondes de conduit d'écorchure	857
Forceps en pierre d'écorchure	858-860
Godets en pierre d'écorchure	860-862
Dilateurs de conduit d'écorchure	862, 863
Forceps de calcul rénal	864
& de calcul d'uretère ; Forceps de Nephrostomy	865
Rein élevant le forceps	867
Forceps de Pedical de rein	868

## Page 767 To 807



& de tissu ; Forceps de possession d'organe	767-770
Forceps de dissection	771
& intestinal ; Brides d'estomac	772-784
Brides intestinales d'Atrauma	785-789
Forceps sigmoïde d'Atrauma	790-793
Dissecteurs d'oesophage	794
Spéculums rectaux	795-799
Forceps hémorroïdal	800, 801
Ciseaux rectaux	801, 802
Ligateurs hémorroïdal	802, 803
Forceps de biopsie	804-806
Supports de tige	806, 807

## Page 869 To 877

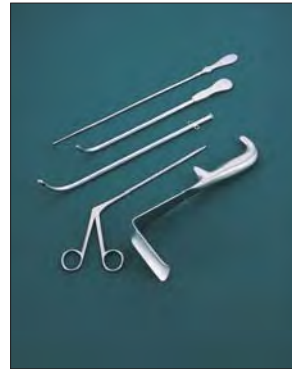

Rétracteurs de réservoir souple	869
Rétracteurs prostatiques	869, 870
Instruments génito-urinaires	872-877

## Page 808 To 855



Forceps de bouledogue d'Atrauma	808, 809
Forceps cardio-vasculaire d'Atrauma	809-837
& néonatal ; Brides pédiatriques	838-840
Brides d'aorte d'Atrauma	841
Forceps de tissu d'Atrauma	842, 843
& aortique de dilateurs ; Biotome	844, 845
Instruments de perçage d'un tunnel	846
Endarterectomy	847
spatules vasculaires	848
L'aorte maintient le & ; Rétracteurs	849
Valvulotomes	851
& de navire ; Brides caves de Vana	852-855

## Page 878 To 943



Forceps utérin de Tenaculum	878-887
Forceps utérin de Polypus	888
Forceps de élévation utérin	889, 890
Forceps utérin de biopsie	891-898
& de Myoma ; Instruments Tubal micro	899
Bruits utérins	900
& de coton ; Supports caustiques	901
& utérin de dépresseur ; Dilateurs	902-906
& de biopsie ; Curettes utérins	907-916
Curettes d'aspiration	917
Godets utérins	918, 919
& vaginal de spéculums ; Rétracteurs	921-943



## Page 943 To 964



& de placenta ; Forceps d'Ovum	944-950
Forceps d'aillon de cuir chevelu	951
Curettes d'Ovum	952
Godets d'avortement	952
& ombilical ; Ciseaux d'épisiotomie	953
Pelvimeters	954, 955
Cranioclast	956
Basiotribes	957
Forceps obstétrique	958-964

## Page 965 To 989

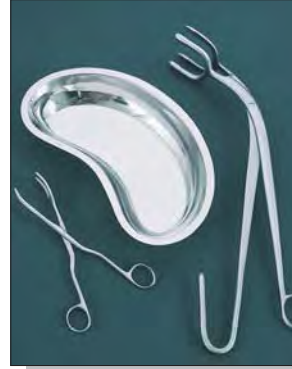

Forceps de stérilisation	965-968
Brides de tuyauterie	969
Cas de stérilisation, supports	970-975
& de plateaux ; Stockage des cas	
& de stérilisation ; Habillage des boîtes	976, 977
Fioles de stérilisation	977, 978
Réceptacles	979, 980
Irrigateurs, & de cruches ; Fioles	981
& rond de cuvettes ; Plats	982, 983
& de plateaux d'instrument ; Boîtes	984-986
& de plateaux de rein ; Pot urinaire	987, 988
Réceptacles de coton	989

## Page 1 To 19



Hauptspiegel	1-3
Hauptbänder & Lichter	3, 4
Stethoscoopes	5-8
Zusätze für Stethoscoopes	9
Messinstrumente	10
Aesthesiometers	11
Diagnostiksätze	12-14
Anästhesie-Schablonen	15
Perkussions-Hammer	16-19

## Page 87 To 103



Scheren mit Hartmetall-Einsätzen	87-103
----------------------------------	--------

## Page 20 To 43



Skalpell-Handgriffe	20-23
Rasiermesser-Blatthalter & Unterbrecher	24
BetriebsSkalpelle	25-32
Dura & Fistel-Messer	32, 33
Abszeß & Kegelmesser	34, 35
Postmortemmesser	36-40
Amputierung-Messer	41, 42
Rasiermesser	42
Haut-Verpflanzung-Messer	43

## Page 104 To 115



Ciseaux de bandage	104-107
Tuch-Scheren	108
Pflaster-Scheren	109-111
Pflaster-Unterbrecher	112
Plasyer Spreizer	113
Pflaster-Messer	114
Pflaster-Heber	115
Pflaster-Trephine	115
Pflaster-Sägen	115

## Page 44 To 86



Empfindliche Scheren	44-52
Verbindung-Scheren	53, 55
Betriebscheren	56-64
Zergliedernscheren	65-71
Gefäßscheren	72-77
Neurochirurgische Scheren	78
Mandel & Nasale Scheren	79, 78
Gynäkologische Scheren	81-85
Episiotomy-Scheren	85
Nabel & Gummi-Scheren	86

## Page 116 To 119



Amputierung-Sägen	116-119
Draht-Sägen	119

## Page 120 To 127



Nagel-Quetschwalzen	120, 121
Häutchen-Quetschwalzen	122
Nagel-Messer	123
Nagel-Spachteln	124, 125
Nagel-Exkavatoren & Akten	125
Nagel-Scheren	126, 127
Häutchen-Scheren	127

## Page 161 To 228



Blutstillende Zange	161-178
Gewebe & Organ-Zange	179, 180
Zergliedern& Verbindung-Zange	181-186
Bronchus & Abschürfung-Luftschacht-Klemmplatten	187-189
Niere Pedicale Klemmplatten	190, 191
Hysterektomie-Zange	192-196
Vaginale Zange	197-200
Atrauma Zange	201-203
Peritoneale Klemmplatten-Zange	204-206
Bulldog & Schlauchklemmplatten	207-210
Tuch-Zange	211-214
Kleiden der Zange	215-228

## Page 128 To 157

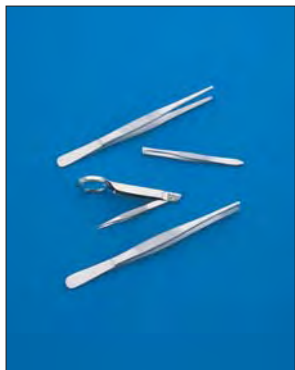

Kleiden von & Gewebe-Zange- Bajonett geformt	128-141
Kleiden von & Gewebe-Zange- eckiges geformtes	142
Splitter-Zange	143
Wimper-Zange	144-147
Spezielle Zange	148-150
Mikrozange	151, 152 154-157

## Page 229 To 240



Trocars	229-233
Saugschläuche	234-240

## Page 158 To 160

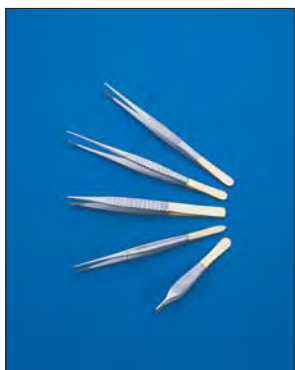

Kleiden von & Gewebe-Zange mit Hartmetall-Einsätzen	158-160
--	---------

## Page 241 To 268



Nadel-Halter	241-257
Nadel-Halter mit Hartmetall-Einsätzen	258-268

## Page 269 To 275



Mikronadel-Halter	269-274
Mikronadel-Halter-Bajonett formte	275

## Page 420 To 432



Holzhammer	420-425
Meniscectomy-Messer	426, 427
Meniscectomy & Knorpel-Zange	428
Tendon saisissant des instruments	429-432

## Page 276 To 297



Reverdin Nadeln	276-278
Naht-Nadeln	279-286
Naht-Leiter	287-290
Naht-Instrumente	291-294
Naht & Taschen-Instrument-Sätze	295-297

## Page 443 To 483



Knochen-Meißel, Hohlmeißel & Osteotomes	433-447
Besetzer	448
Raspatories	449-460
Knochen-Aufzüge	461-463
Knochen-Hebel	463-472
Knochen-Akten	473-475
KnochenCurettesBone Curettes	476-483

## Page 298 To 419



Retraktoren	298-405
Abdominal- Retraktoren	406-414
Blasen-Retraktoren	415-418
Laminectomy-Retraktoren	419

## Page 484 To 519



Knochen-Ausschnitt-Zange	484-490
Knochen Rongeurs	491-502
Knochen-Holding-Zange	503-515
Knochen-Holding-Klemmplatten	516, 517
Nagel-Instrumente	518, 519

## Page 520 To 555



Rippen-Scheren	520-522
Sternum-Instrumente & Röstern	523
Sie.	524-535
Rippen-Spreizer	536, 537
Bronchus-Zange	537
Lungenflügel, der Zange greift	538-540
Handbohrgeräte	541-543
Schrauben-Fahrer	544
Platte & Schrauben-Halter	545-547
Verlängerungs-Bögen	548
Draht-Führer	549-551
Flaches Nasen-Zangen & Zange	552-555

## Page 580 To 598



Kehlkopfspiegel	580, 581
Kehlkopfspiegel-Handgriffe	580, 581
Laryngeal Polypus Forceps	582, 583
Temporomandibular Instrumente	584
Disimpaction Zange	585
Ahlen	586
Mandel-Messer	587-589
Verbindungsfördermaschinen	590
Mandel-Retraktoren	591
Mandel-Aufzüge	592
Mandel-Nadeln	592-594
Mandel, die Zange ergreift	594, 595
Mandel Haemostats	596
Mandel-Schlingen	596, 597
Mandel lectomes	598

## Page 556 To 561



Laryngoscope-Handgriffe	556, 557
Laryngoscope-Sätze	558-561

## Page 599 To 606



Broncho-	599-604
-Oesophagoscopieszange	
Broncho-	603
-Oesophagoscopieschere	
Kehlkopfschere & Zange	605, 606

## Page 562 To 579



Mund-Gags	562-569
Zunge-Senker	569-572
Backe & Lippenretractoren	572, 573
Finger-Schutze	573
Intramundretractoren	574-576
Ramus & Kinn-Retraktor	577
Zunge-Holding-Zange	578, 579

## Page 607 To 612



LuftröhrenTrocars	607
Luftröhrendilatatoren	607
Luftröhrenretractoren	607-609
Luftröhrenschläuche	610, 611
Tracheotomie-Dilatator-Sätze	612



## Page 613 To 653



Nasaler Speculum	613-618
Nasale Schlinge	618
Nasale Polypus-Zange	619-622
Nasale Ausschnitt-Zange	623, 624
Nasales & Scheidewand-Messer	625-627
Scheidewand-Aufzüge	627-631
Scheidewand-Scheren	632
Rhinoplastic Instrumente	633-644
Rhinoplastic Zange & Scheren	645, 646
Rhinoplastic Hammer	647
Adenoide Curettes	648-652
Katheter & Cannulas	652, 653

## Page 680 To 701



OhrSpecula	680-683
Stimmgabeln	683-687
Messer	688, 689
Paracentesis Nadeln	689-692
Nadeln, Auswahl & Haken	693
Zergliederer & Elavators	694
Footplate Handinstrumente	695
Curettes & Schleifen	696, 697
Fremder Körper-Instrumente	698
Hooklets	699
Exkavatoren & Aufzüge	700
Ohr-Spritzen	701

## Page 654 To 668



Durchschläge Kerrison, Hajek, Colclough & Sybert etc.	654-662
Rongeurs Cushing, Weil-Blakesley & Caspar etc.	662-668

## Page 702 To 746



AugeSpeculum	702, 703
Kappe Everters & Retraktoren	704
Augen-Skalpelle & Messer	705-710
Fremder Körper-Hohlmeißel	711
Haken & Hooklets	712
Augeninstrumente	713-721
Trephines & Burs	722
Meißel, Hohlmeißel & Aufzüge	Double Instruments 723
Doppelte Instrumente	724
Augen-Zange	725-738
Augen-Scheren	738-744
Nadeln & Auge OP. Sätze	744-746

## Page 699 To 679



Steinhauser Instrumente	699, 670
Ohrpolypus-Schlingen	671
Ohrpolypus-Zange	672, 673
Mikroohr-Zange	674-676
Mikroohr-Scheren	676, 677
Draht-Schliessen-Zange	678
Einleitung Instrumens	679
Crura & Malleus-Quetschwalzen	679

## Page 747 To 764

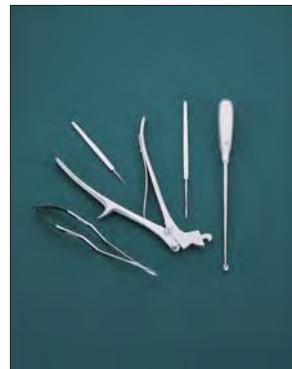

Nerven Mikroscheren	747, 748
Nerven Nadel-Mikrohalter	748
Mikromesser & Haken	749
Mikroverbindung-Führer	750
Mikrozergliederer & Zange	751
Mikroscheren	752
Mikro befestigt & Anwenden von Forcep	753, 754
Schädelöffner	754, 755
Schädelöffner	755, 756
Dura Zergliederer & Haken	757-760
Pituitäre Curettes	760, 761
Messer, Separatoren & Retraktoren	762-764

## Page 765 To 766



LucasCurrettes	765
Hooklets	765
Comedo-Auszieher	766

## Page 856 To 868

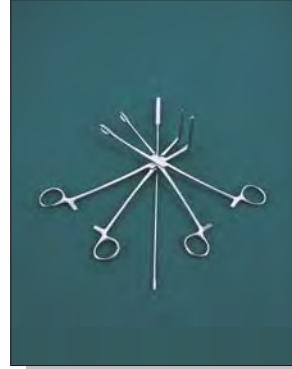

Abschürfung-Luftschaft-Zange	856, 857
Abschürfung-Luftschaft-Prüfspitzen	857
Abschürfung-Steinzange	858-860
Abschürfung-Steinschaufeln	860-862
Abschürfung-Luftschaft-Dilatatoren	862, 863
Niere-Stein-Zange	864
Ureter-Kalkül & Nephrostomy Zange	865
Niere, die Zange erhöht	867
Niere Pedical Zange	868

## Page 767 To 807



Gewebe & Organ-Holding-Zange	767-770
Zergliedernzange	771
Intestinales & Magen-Klemmplatten	772-784
Atrauma intestinale Klemmplatten	785-789
Atrauma halbmondförmige Zange	790-793
Ösophagus-Zergliederer	794
Rektale Specula	795-799
Hämorrhoidale Zange	800, 801
Rektale Scheren	801, 802
Hämorrhoidales Ligators	802, 803
Biopsie-Zange	804-806
Putzlappen-Halter	806, 807

## Page 869 To 877

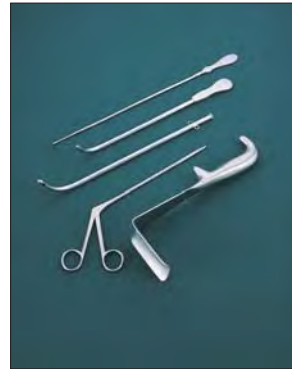

Blasen-Retraktoren	869
Prostataretraktoren	869, 870
Genito-urinäre Instrumente	872-877

## Page 808 To 855



Atrauma Bulldogge-Zange	808, 809
Atrauma kardiovaskuläre Zange	809-837
Neugeborenes & Pädiatrische Klemmplatten	838-840
Atrauma Aorta-Klemmplatten	841
Atrauma Gewebe-Zange	842, 843
Aortendilatatoren & Bioptom	844, 845
Tunnelbau-Instrumente	846
Endarterectomy	847
Gefäßspachteln	848
Aorta klemmt & fest; Retraktoren	849
Valvulotomes	851
Behälter & Vana Cava Klemmplatten	852-855

## Page 878 To 943



Uterine Tenaculum Zange	878-887
Uterine Polypus-Zange	888
Uterine erhöhenzange	889, 890
Uterine Biopsie-Zange	891-898
Myoma & Tubal Mikroinstrumente	899
Uterine Töne	900
Baumwolle & Ätzende Halter	901
Uterines Senker & Dilatatoren	902-906
Biopsie & Uterine Currettes	907-916
AspirationCurrettes	917
Uterine Schaufeln	918, 919
Vaginale Specula & Retraktoren	921-943

## Page 943 To 964



Plazenta & Ovum-Zange	944-950
Kopfhaut-Klappen-Zange	951
OvumCurettes	952
Abtreibungs-Schaukeln	952
Nabel& Episiotomy-Scheren	953
Pelvimeters	954, 955
Cranioclast	956
Basiotribes	957
Obstetric Zange	958-964

## Page 965 To 989

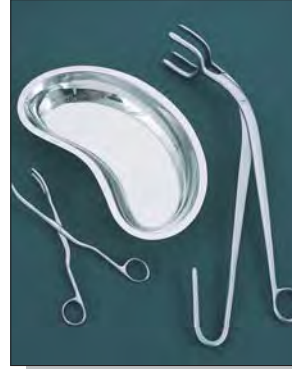

Entkeimenzange	965-968
Schlauchklemmplatten	969
Entkeimfälle, Zahnstangen	970-975
Behälter & Speicherung von Fällen	
Entkeimen& Kleiden der Kästen	976, 977
Entkeimgläser	977, 978
Behälter	979, 980
Irrigators, Krüge & Gläser	981
Rundes Schüsseln & Teller	982, 983
Instrument-Behälter & Kästen	984-986
Niere-Behälter & Urinausscheidender Topf	987, 988
Baumwollaufnahmewannen	989



Ziegler-Renova  
**1-01-90**  
90 mm Ø

1/2

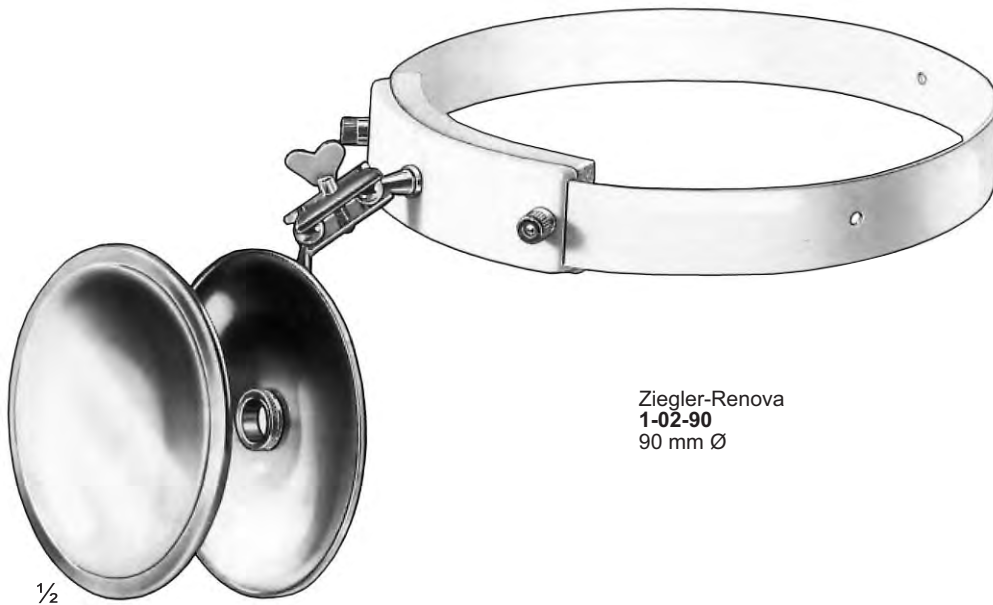

Ziegler-Renova  
**1-02-90**  
90 mm Ø

1/2



Ziegler-Renova  
**1-03-90**  
90 mm Ø

1/2



Ziegler  
2-01-90 90 mm Ø  
2-02-100 100 mm Ø



Ziegler  
2-03-90 90 mm Ø  
2-04-100 100 mm Ø

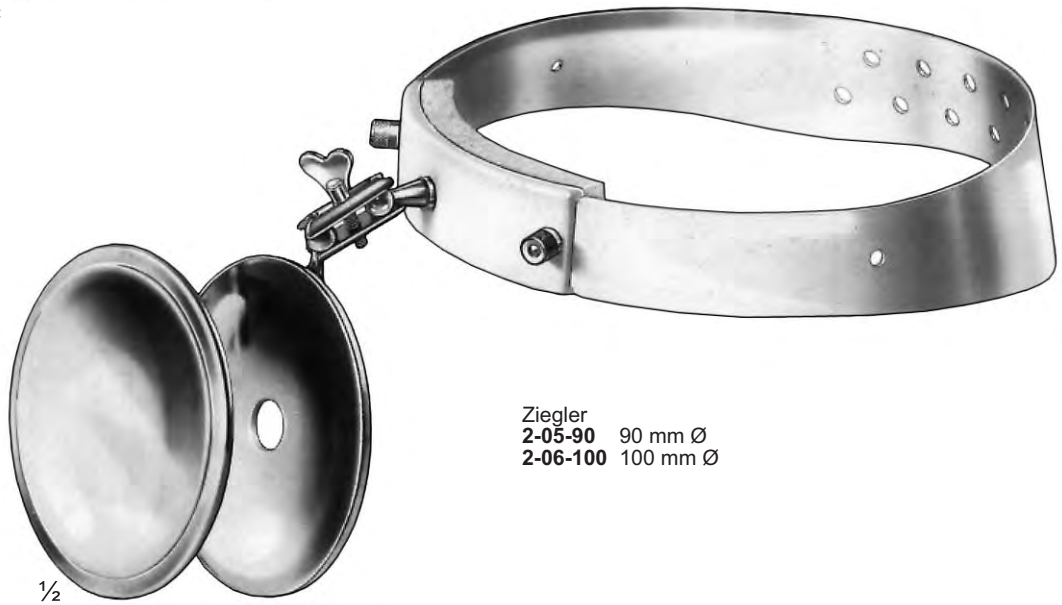

Ziegler  
2-05-90 90 mm Ø  
2-06-100 100 mm Ø



# Stirnlampen Head Bands & Lights Eclaireurs Frontaux

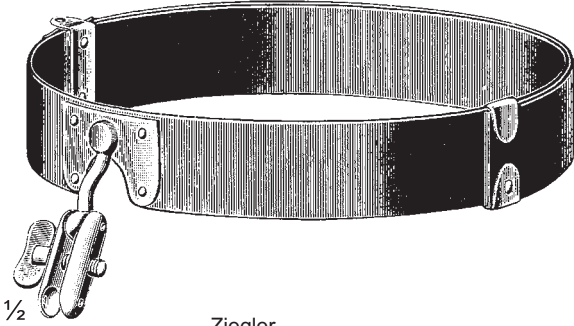

1/2

Ziegler  
3-01-90 90 mm Ø  
3-02-100 100 mm Ø

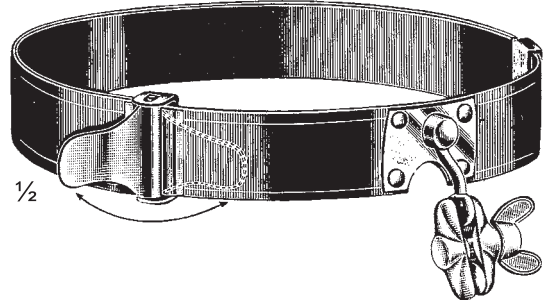

1/2

Ziegler-Renova  
3-03-90 90 mm Ø  
3-04-100 100 mm Ø

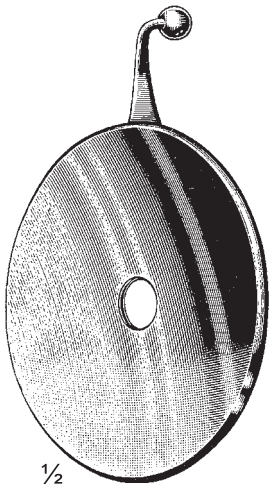

1/2

Ziegler  
3-05-90 90 mm Ø  
3-06-100 100 mm Ø  
Head mirror only

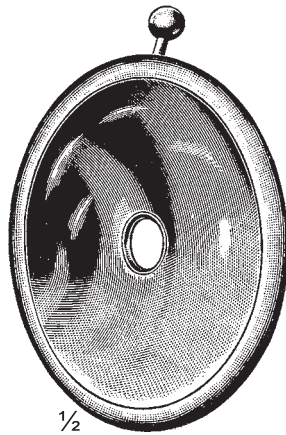

1/2

Ziegler  
3-07-90 90 mm Ø  
3-08-100 100 mm Ø  
Head mirror only  
with rubber edging

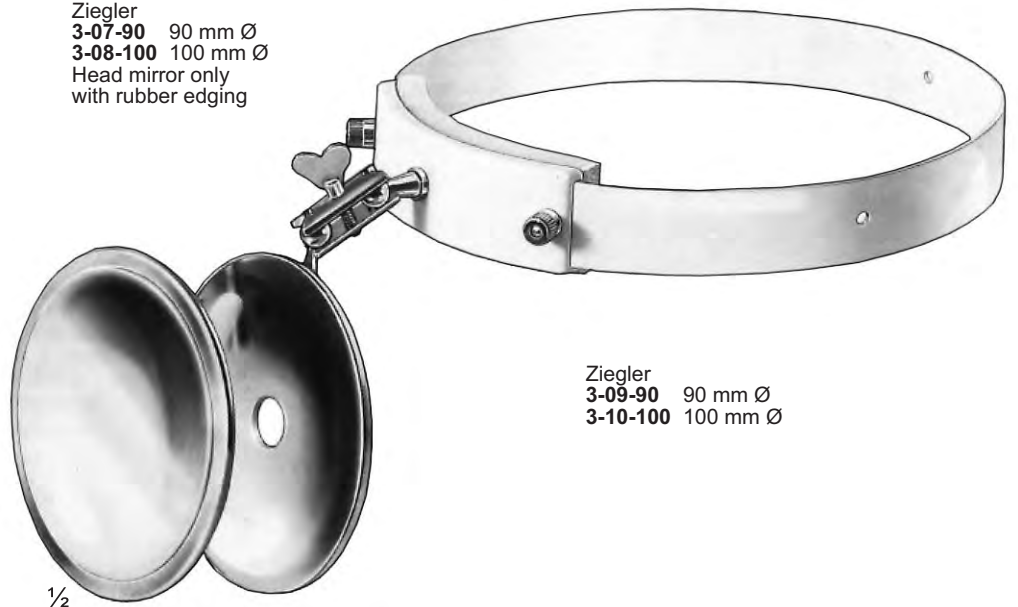

1/2

Ziegler  
3-09-90 90 mm Ø  
3-10-100 100 mm Ø



**4-01-00**



**4-02-00**  
Protecting shield only

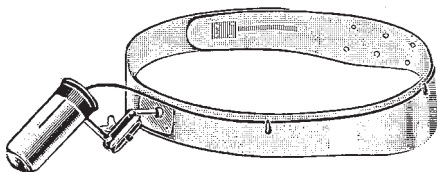

Jansen  
**4-03-90** 90 mm Ø  
**4-04-100** 100 mm Ø

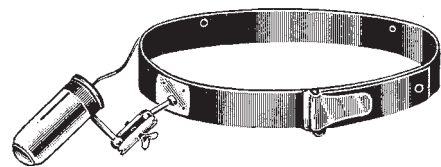

Jansen  
**4-05-90** 90 mm Ø  
**4-06-100** 100 mm Ø

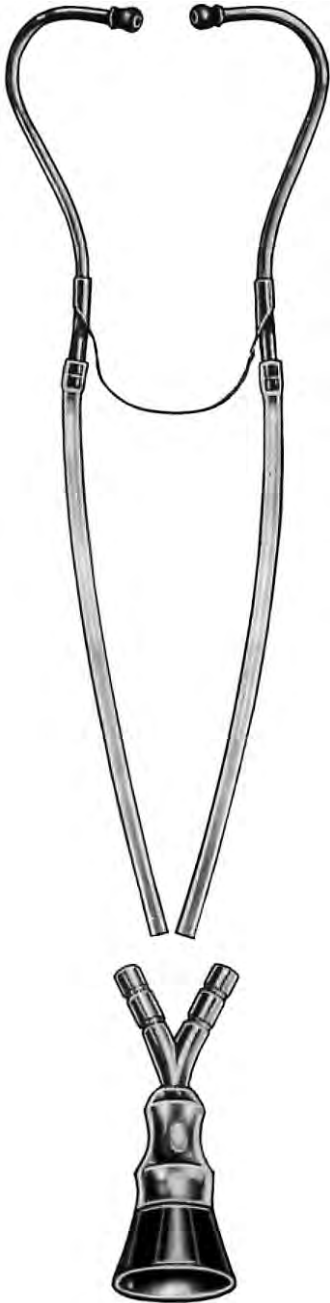

Ford  
5-01-00  
Double outlet

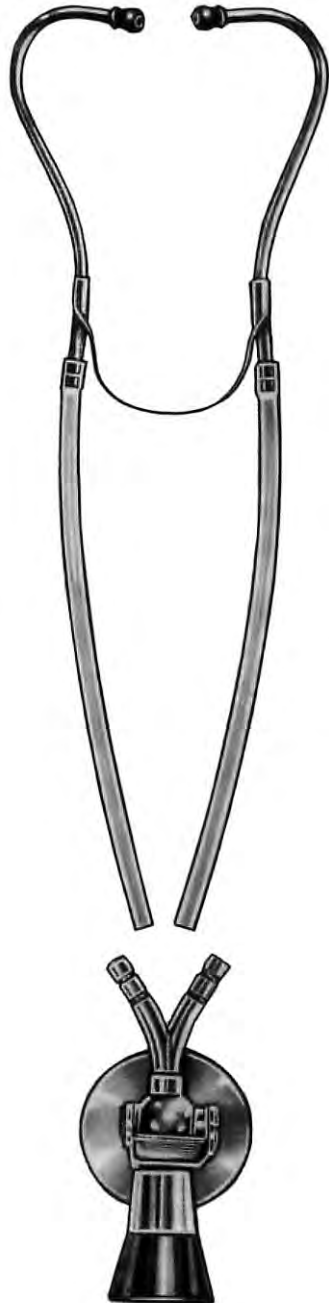

5-02-00  
Double outlet



Bowles  
5-03-00  
Single outlet



5-04-00  
Single outlet



5-02-00



5-03-00



**Streamliner  
6-01-00**  
Single outlet

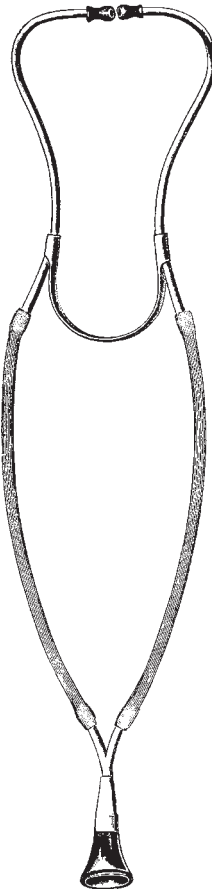

**Snowden  
6-02-00**  
Double outlet

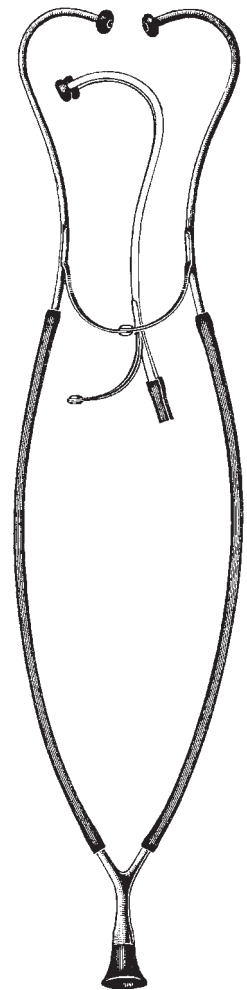

**Snowden  
6-03-00**  
Double outlet  
Folding  
frame



**6-02-00**

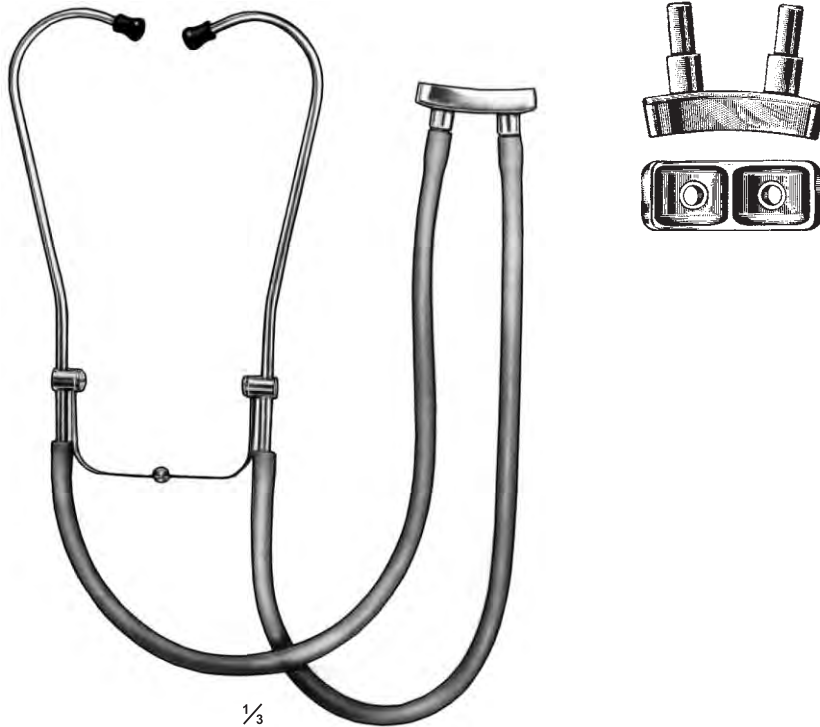

$\frac{1}{3}$   
Hartert (Stereo)  
7-01-00  
Double outlet



$\frac{1}{3}$   
Triofon  
7-02-00  
Single outlet



$\frac{1}{3}$   
Reiger-Sprague  
7-03-00  
Double outlet





1/3

**Anestophon  
8-01-00**  
Single outlet



1/2

**Pinard  
8-02-15**  
15.5 cm / 6 1/4"

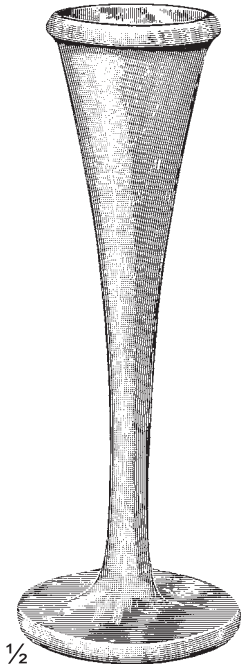

1/2

**Pinard  
8-03-18**  
18 cm / 7"



1/2

**8-04-14**  
14.5 cm / 5 1/2"  
Wooden



1/2

**Pinard  
8-05-15**  
15 cm / 6"

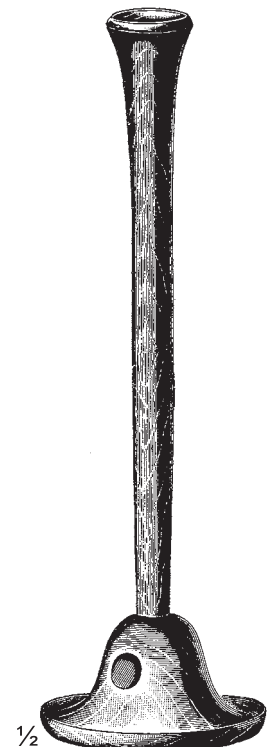

1/2

**Scholle  
8-06-19**  
19 cm / 7 1/2"

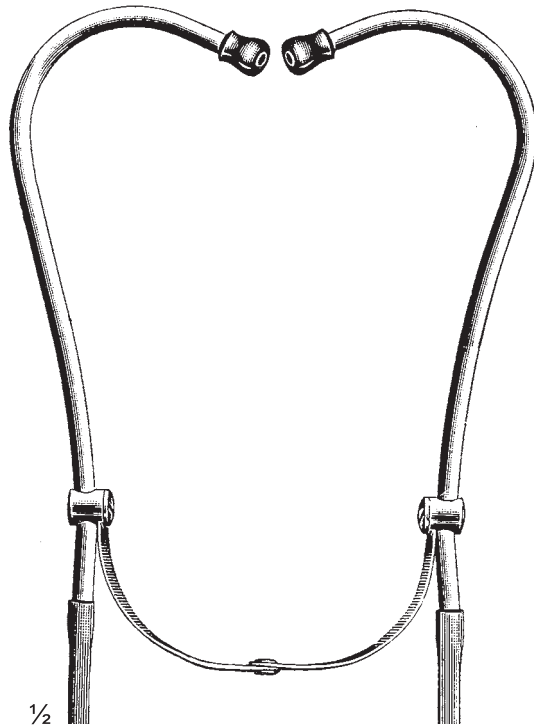

**9-01-00**  
Binaural,  
Spring screwed on



**9-02-00**



**9-03-00**  
Binaural, Short type



**1/2**  
**9-04-00**

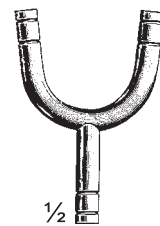

**1/2**  
**9-05-06**  
6 mm Ø

**Messinstrument-  
Measuring Instruments  
Instrument Pour Mesurer**



1/2

Castroviejo  
10-01-07  
7.5 cm / 3"



1/2

10-02-15  
15 cm / 6"

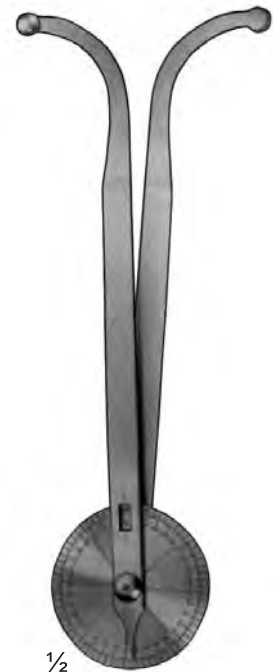

1/2

Thole  
10-05-00



Bertillon  
10-03-32  
32 cm / 12 3/4"



1/3

Moeltgen  
10-04-18  
18 cm / 7"

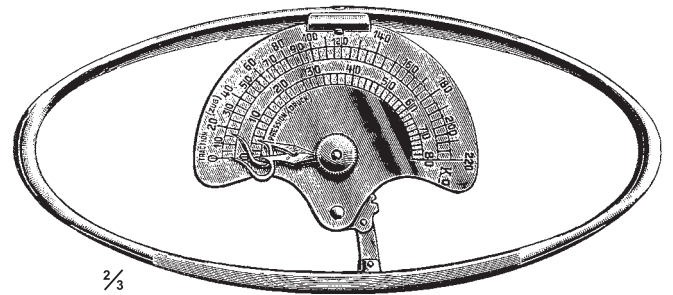

2/3

Collin  
10-06  
12.5 cm / 5"  
Pressure traction  
100-300 Kg



1/2  
Aly  
11-01-17  
17 cm / 6 3/4"

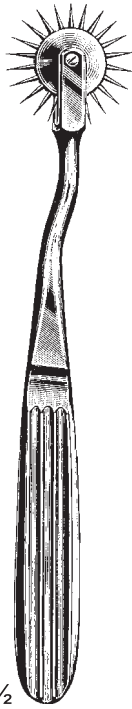

1/2  
Wartenberg  
11-02-19  
19 cm / 7 1/2"

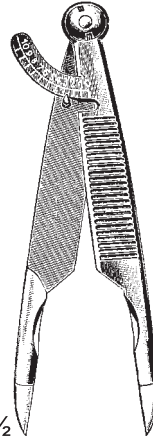

1/2  
Weber  
11-03-11  
11 cm / 4 1/4"



1/2  
Weber  
11-04-17  
17 cm / 6 3/4"



1/2  
11-05-23  
23 cm / 9"



1/2  
11-06-26  
26 cm / 10 1/4" 45°



1/2  
11-07-24  
24 cm / 9 1/2" 90°



**12-01-00**  
Battery handle



**12-02-00**  
Battery handle



**12-03-00**  
Battery handle



$\frac{1}{2}$   
**12-04-00**  
Battery handle

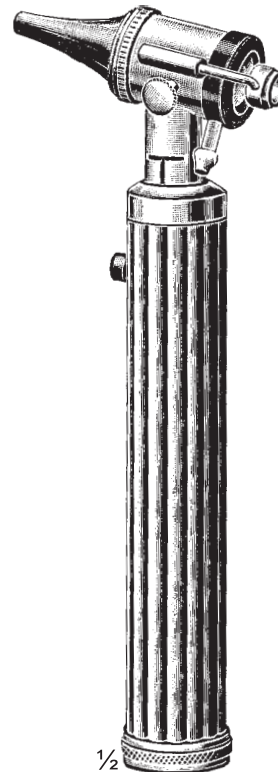

$\frac{1}{2}$   
**Chiron**  
**12-05-00**  
Otoscope

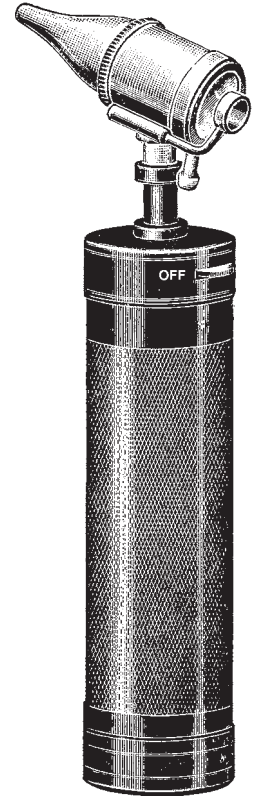

**12-06-00**  
Otoscope



**12-07-00**  
Complete set consisting :  
1 Battery handle, 1 Nasal speculum  
3 Ear specula, 1 Tongue blade, 1 Mirror handle  
4 Bulbs and 2 Mirrors



**12-08-00**  
Complete set consisting :  
1 Battery handle, 1 Nasal speculum  
3 Ear specula and 2 Bulbs





1/3

Universal  
**13-01-00**

Complete set consisting :  
1 Battery handle, 1 Otoscope with 3 ear specula,  
1 Ophthalmoscope, 1 Nasal speculum, 2 Mirrors with holder,  
1 Tongue depressor holder and 2 Bulbs



**13-02-00**

Complete set consisting :  
1 Battery handle, 5 Ear specula,  
1 Nasal speculum and 1 Tongue blade holder



**13-03-00**

Complete set consisting :  
1 Battery handle, 1 Otoscope with 3 Ear specula,  
1 Nasal speculum, 1 Mirror with holder and  
1 Tongue blade



**Halnaso**  
**14-01-00**  
 Complete set consisting :  
 1 Battery handle, 3 Ear specula, 1 Nasal speculum,  
 2 Mirrors with holder, 1 Tongue depressor holder and  
 2 Bulbs



**14-02-00**  
 Otoscope set consisting :  
 1 Battery handle, 3 Ear specula and 1 Bulb



**14-03-00**  
 Ophthalmoscope set consisting :  
 1 Battery handle, 1 Ophthalmoscope with 3 stepless focusing,  
 1 Illumination lens and 1 Bulb



**14-04-00**  
 Complete set consisting :  
 1 Battery handle, 5 Ear specula, 1 Nasal speculum,  
 1 Bulb, 1 Speculum holder, 1 Wire spatula and  
 2 Wooden spatulas

**Empfindungslosigkeit Verkleidet  
Anaesthesia Masks  
L'anesthésie Masque**

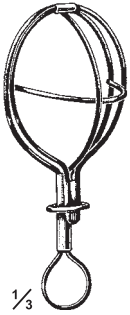

Baby-Esmarch  
15-01-00

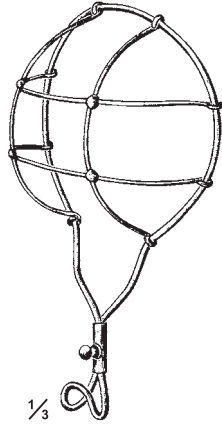

Esmarch  
15-02-00

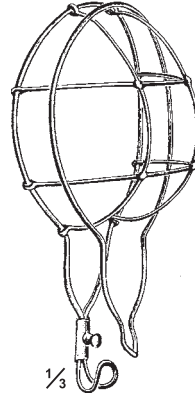

Esmarch  
15-03-00

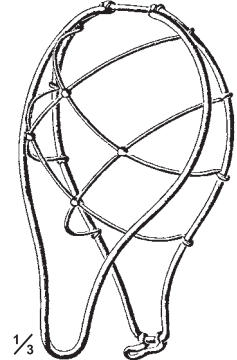

Esmarch  
15-04-00

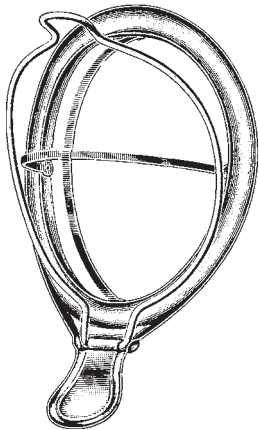

Schimmelbusch  
15-05-00

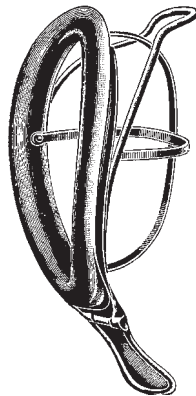

Schimmelbusch  
15-06-00

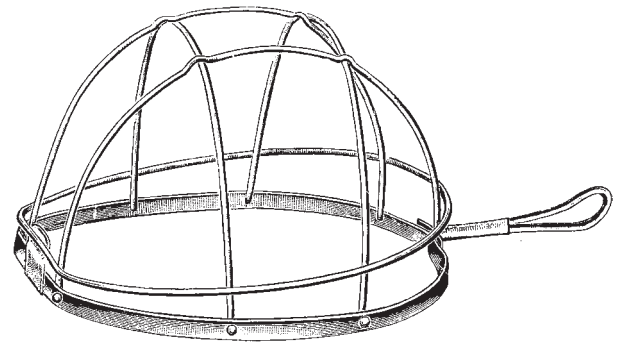

Juillard  
15-07-00

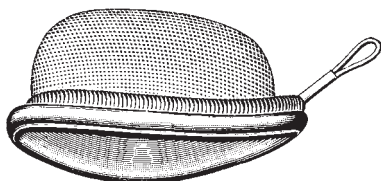

Yankauer  
15-08-00

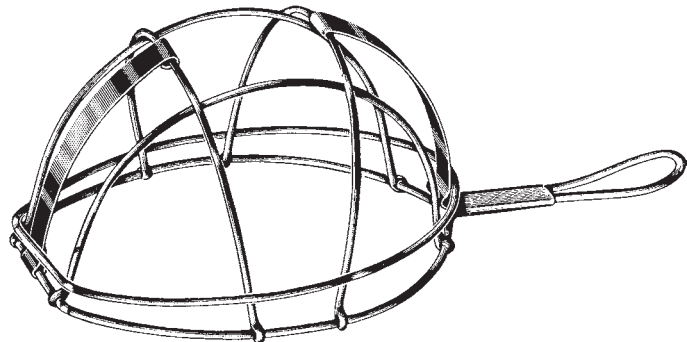

Juillard  
15-09-00

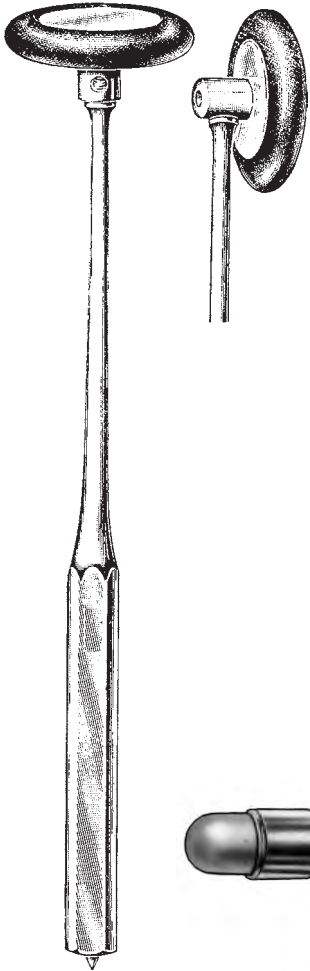

Babinski  
**16-01-22**  
22 cm / 8<sup>3</sup>/<sub>4</sub>"

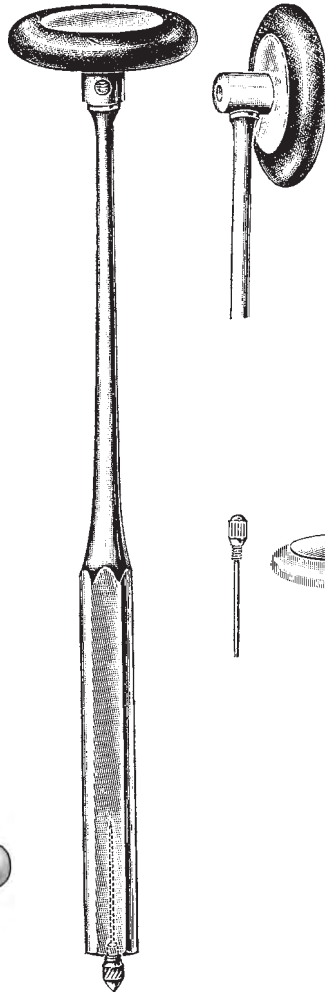

Babinski  
**16-02-22**  
22 cm / 8<sup>3</sup>/<sub>4</sub>"

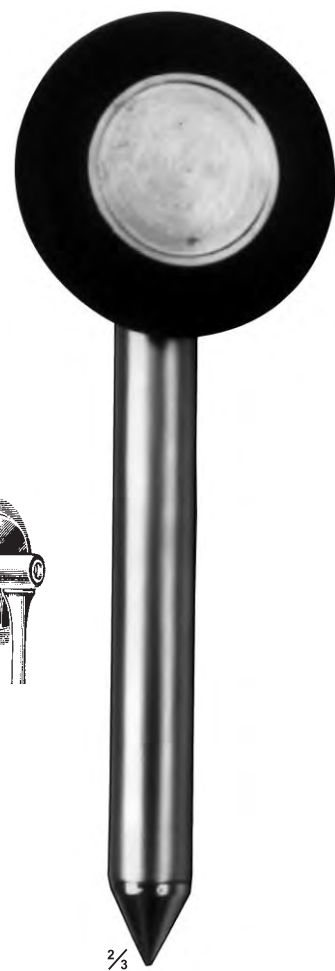

$\frac{2}{3}$   
Telescopic  
**16-03-15**  
Closed size 15 cm / 6"



Telescopic  
**16-03-15**  
Full  
Opening  
38 cm / 15"



$\frac{1}{2}$   
Buck  
**16-04-18**  
18 cm / 7"  
Closed size 9 cm / 3<sup>1</sup>/<sub>2</sub>"

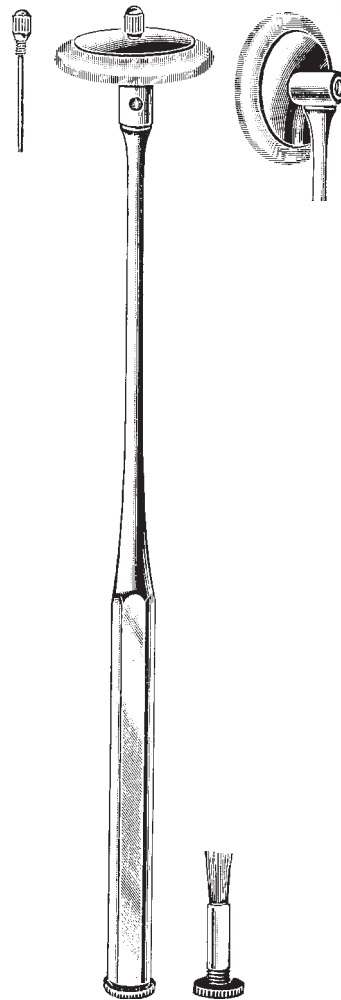

Rabiner  
**16-05-25**  
25 cm / 10"

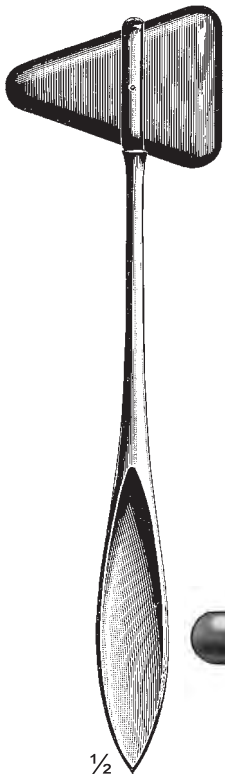

$\frac{1}{2}$   
Taylor  
17-01-18 18 cm / 7"  
17-02-20 20 cm / 8"

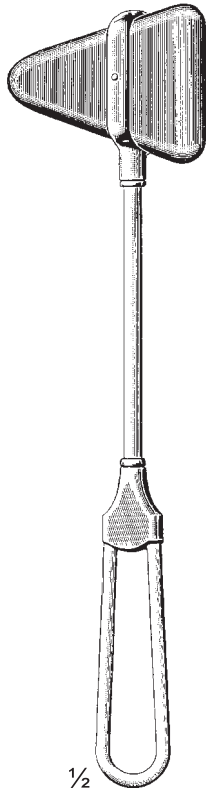

$\frac{1}{2}$   
Taylor  
17-03-18 18 cm / 7"  
17-04-20 20 cm / 8"

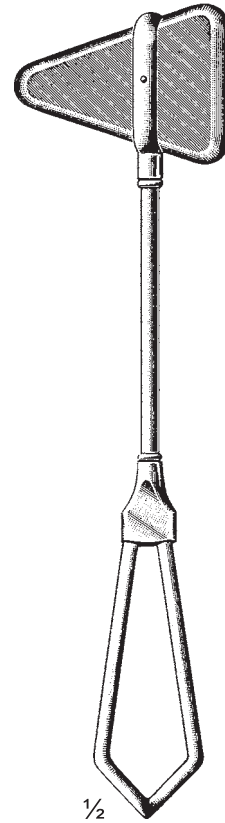

$\frac{1}{2}$   
Taylor  
17-05-18 18 cm / 7"  
17-06-20 20 cm / 8"

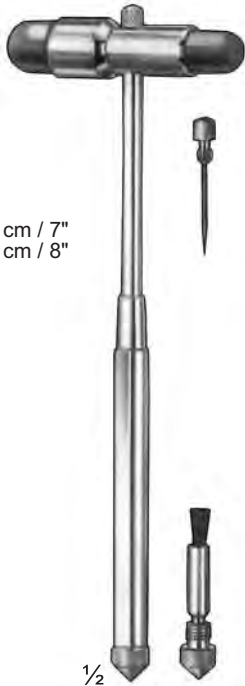

$\frac{1}{2}$   
Buck  
17-07-18 18 cm / 7"  
17-08-20 20 cm / 8"



$\frac{1}{2}$   
Mobile  
17-09-19  
19 cm / 7 $\frac{1}{2}$ "



17-10-18 18 cm / 7"  
17-11-20 20 cm / 8"  
17-12-25 25 cm / 10"  
17-13-30 30 cm / 12"

$\frac{1}{3}$   
Vernon  
17-10 To 17-13



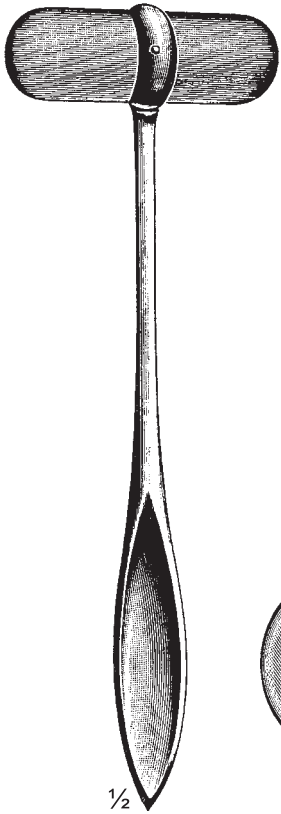

$\frac{1}{2}$   
Dajerine  
18-01-18 18 cm / 7"  
18-02-20 20 cm / 8"

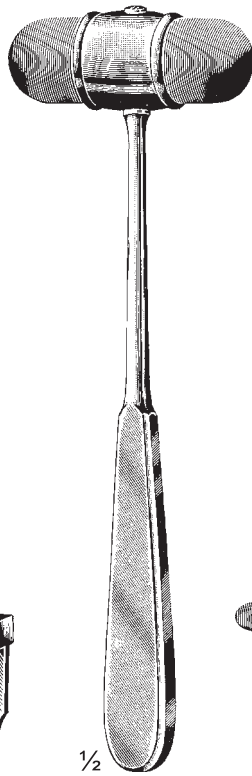

$\frac{1}{2}$   
Dajerine  
18-03-18 18 cm / 7"  
18-04-20 20 cm / 8"

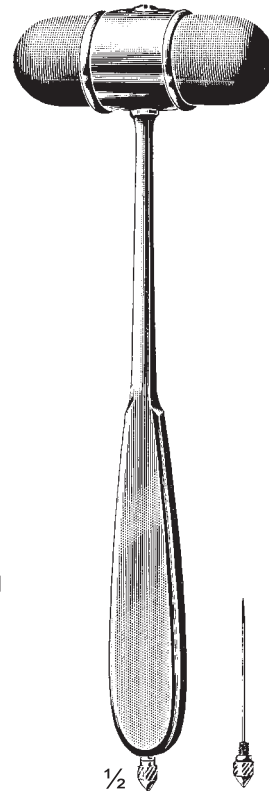

$\frac{1}{2}$   
Dajerine  
18-05-18 18 cm / 7"  
18-06-20 20 cm / 8"

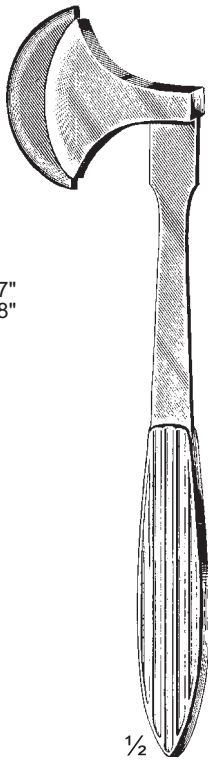

$\frac{1}{2}$   
Berliner  
18-07-18 18 cm / 7"  
18-08-20 20 cm / 8"

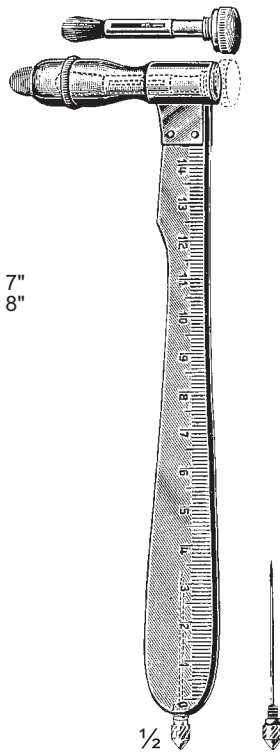

$\frac{1}{2}$   
Ebstein  
18-09-18  
18 cm / 7"

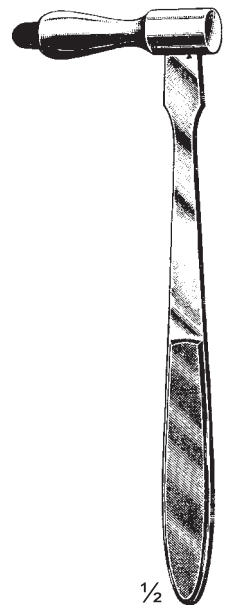

$\frac{1}{2}$   
Traube  
18-10-16  
16 cm / 6 $\frac{1}{4}$ "

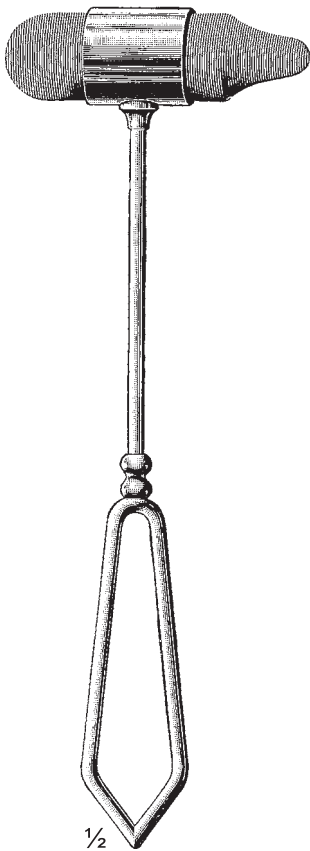

$\frac{1}{2}$   
Drivers Douflex  
Mod. Dejerine  
**19-03-22**  
22 cm / 8 $\frac{3}{4}$ "

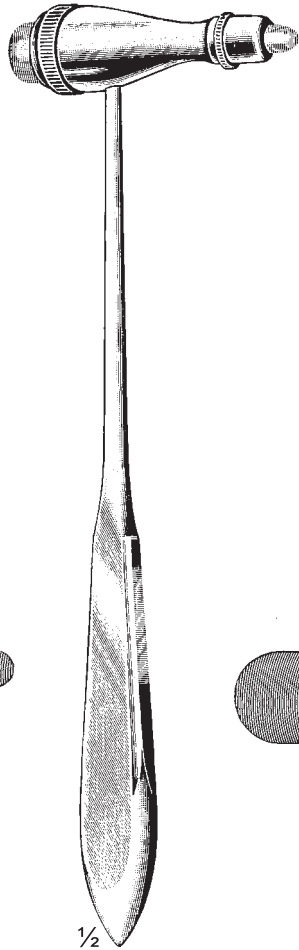

$\frac{1}{2}$   
Troemner  
**19-01-24**  
24.5 cm / 9 $\frac{3}{4}$ "

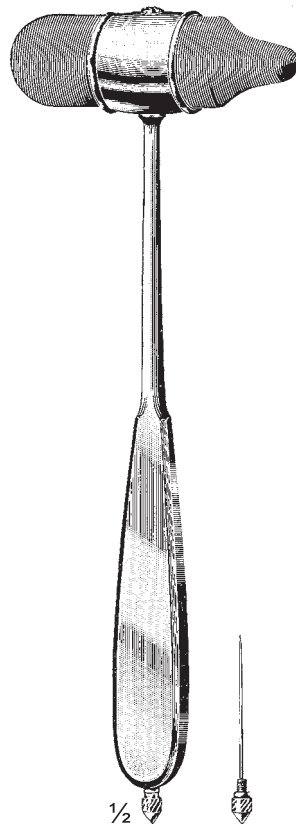

$\frac{1}{2}$   
Neuro Douflex  
Mod. Dejerine  
**19-04-22**  
22 cm / 8 $\frac{3}{4}$ "

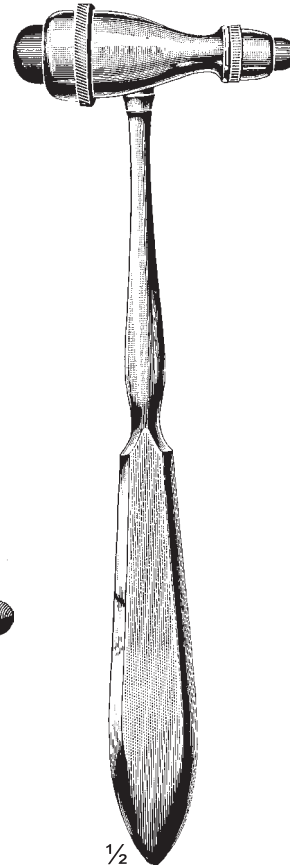

$\frac{1}{2}$   
Troemner  
**19-02-24**  
24 cm / 9 $\frac{1}{2}$ "

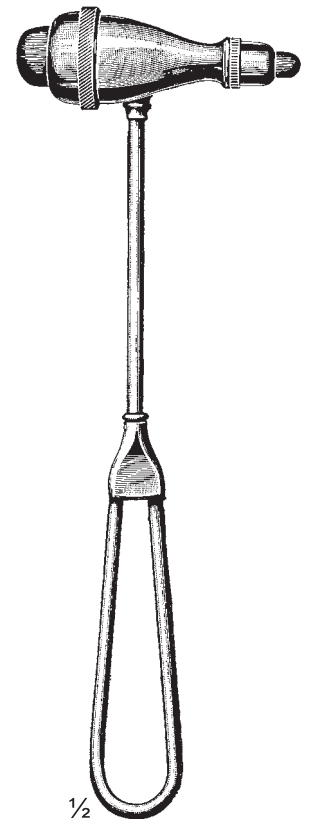

$\frac{1}{2}$   
Troemner  
Simplex  
**19-05-21**  
21 cm / 8 $\frac{1}{4}$ "

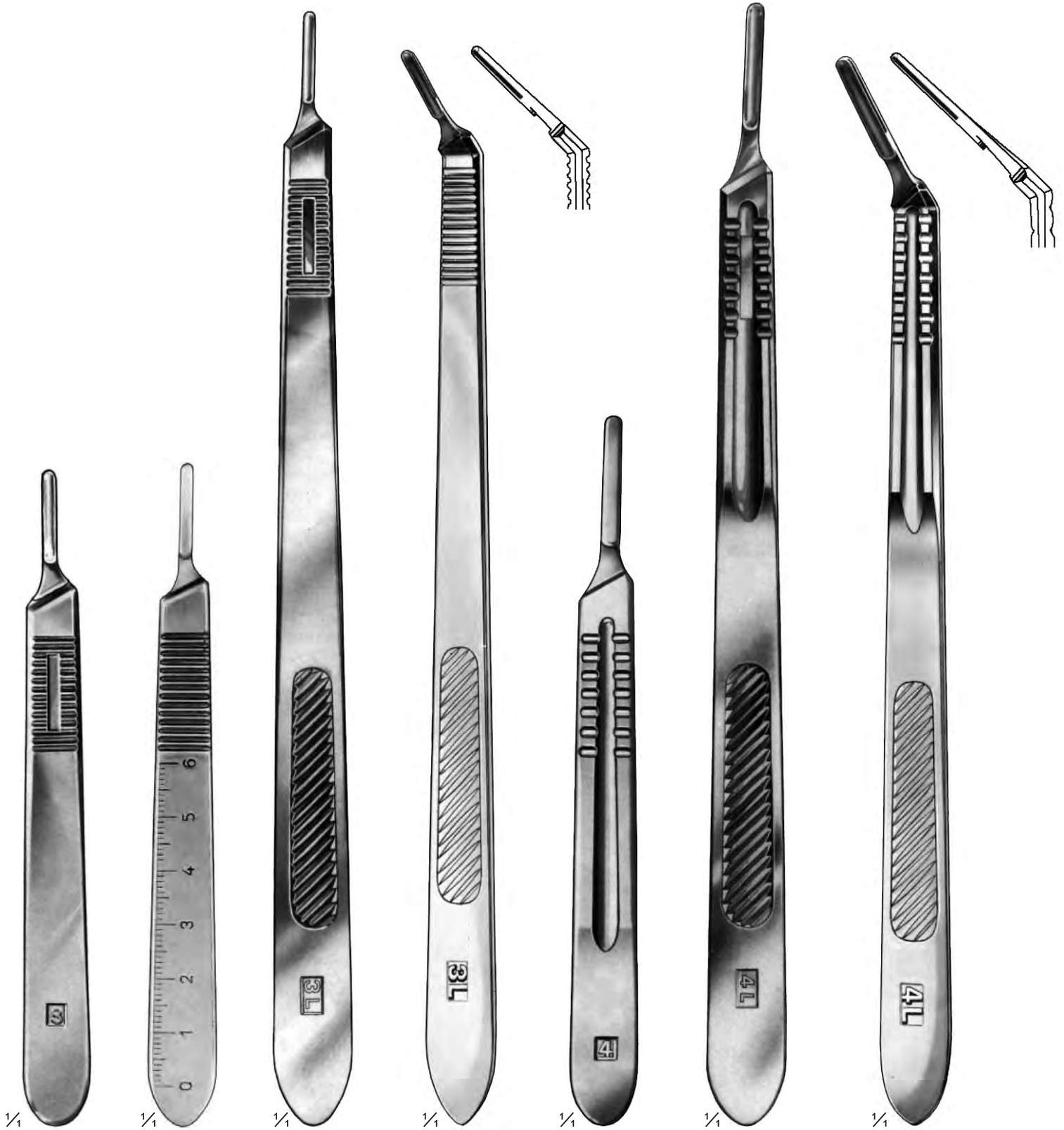

**20-01-03**  
12.5 cm / 5"  
No. 3

**20-02-03**  
12.5 cm / 5"  
No. 3

**20-03-03**  
21 cm / 8¼"  
No. 3 L

**20-04-03**  
20 cm / 8"  
No. 3 L

**20-05-04**  
13.5 cm / 5¼"  
No. 4

**20-06-04**  
21 cm / 8¼"  
No. 4 L

**20-07-04**  
20 cm / 8"  
No. 4 L



21-01-03  
15 cm / 6"  
No. 3  
Hollow  
handle



21-02-34  
15.5 cm / 6 1/8"  
No. 3, 4  
Double ended



21-03-07  
12.5 cm / 5"  
No. 7 K



21-04-07  
16 cm / 6 1/4"  
No. 7



21-05-07  
16 cm / 6 1/4"  
No. 7



21-06-16  
16 cm / 6 1/4"

**Skalpellgriffe  
Scalpel Handles  
Manches Pour bistouris**



$\frac{1}{4}$   
**22-01-03**  
12.5 cm / 5"  
No. 3



$\frac{1}{4}$   
**22-02-04**  
12.5 cm / 5"  
No. 4



$\frac{1}{4}$   
Collin  
**22-03-08**  
13 cm / 5 $\frac{1}{8}$ "  
No. 8



$\frac{1}{4}$   
Collin  
**22-04-09**  
13 cm / 5 $\frac{1}{8}$ "  
No. 9



$\frac{1}{4}$   
**22-05-10**  
15 cm / 6"  
No. 10



**Skalpelli  
Scalpel Handles  
Manches Pour bistouris**



$\frac{1}{4}$   
**23-01-13**  
13 cm / 5 $\frac{1}{8}$ "  
Plastic handle



$\frac{1}{4}$   
**23-02-27**  
27 cm / 10 $\frac{3}{4}$ "

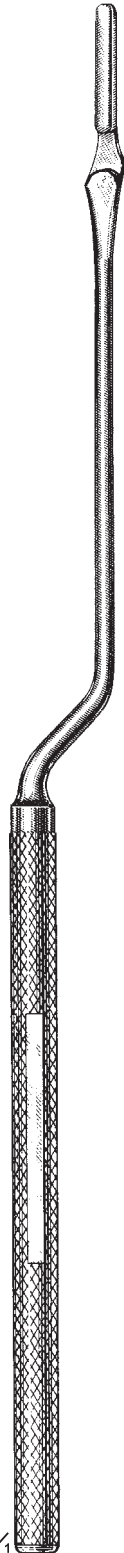

$\frac{1}{4}$   
**23-03-21**  
21 cm / 8 $\frac{1}{4}$ "



$\frac{1}{4}$   
**23-04-23**  
23 cm / 9"

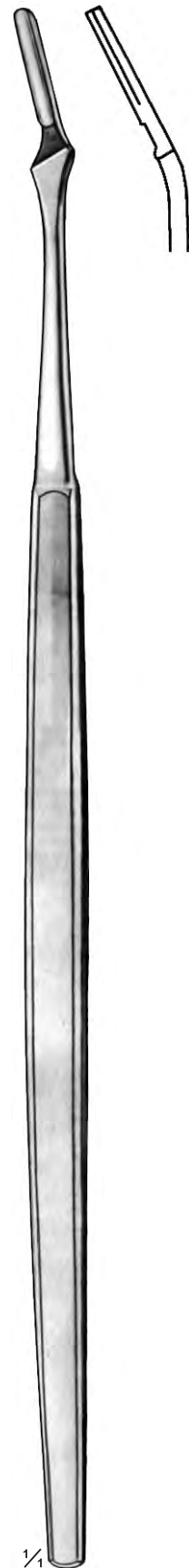

$\frac{1}{4}$   
**23-05-23**  
23 cm / 9"



$\frac{1}{4}$   
**23-06-23**  
23 cm / 9"

# Klingenhalter / Klilngenbrecher Razor Blade Holder & Breakers Pincettes Pour saisir et casser les lames de rasoir



24-02-09  
Cur



24-01-09 Str  
Troutman  
Chris  
24-01-09 & 24-02-09  
9 cm / 3½"  
5.5 mm

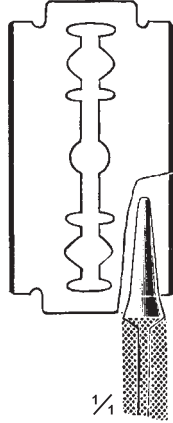

1/4

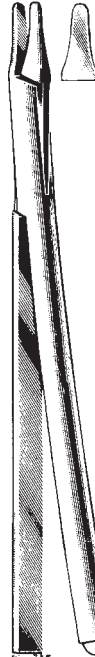

24-05-18  
18.5 cm / 7¼"



24-06-13  
Castroviejo  
13 cm / 5 1/8"  
8 mm



24-03-11  
11 cm / 4¼"

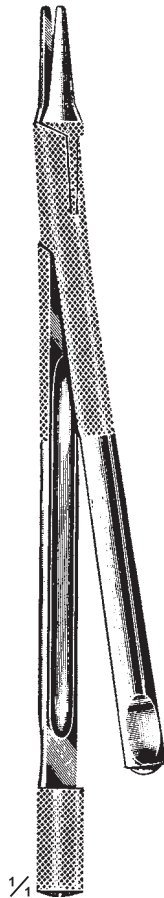

24-04-12  
12 cm / 4¾"



24-07-16  
16 cm / 6¼"

**Anatomische Skalpelle  
Scalpel Handles  
Bistouris à dissection**



**25-01-18 To 25-04-18**  
18.5 cm / 7¼"



25-01-18

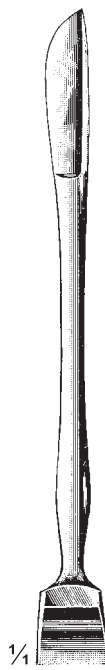

25-02-18



25-03-18

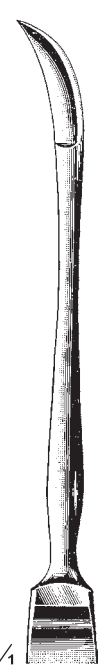

25-04-18

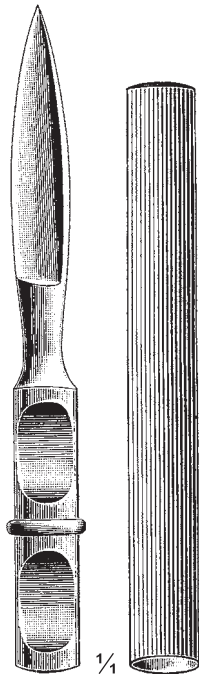

**25-05-16**  
16 cm / 6¼"  
With handle

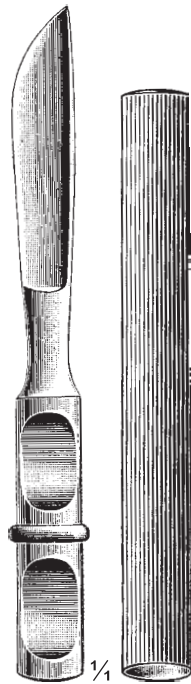

**25-06**  
16 cm / 6¼"  
With handle

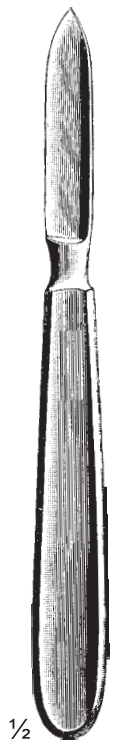

**Farabeuf  
25-07**  
19 cm / 7½"

**Anatomische Skalpel  
Scalpel Handles  
Bistouris à dissection**

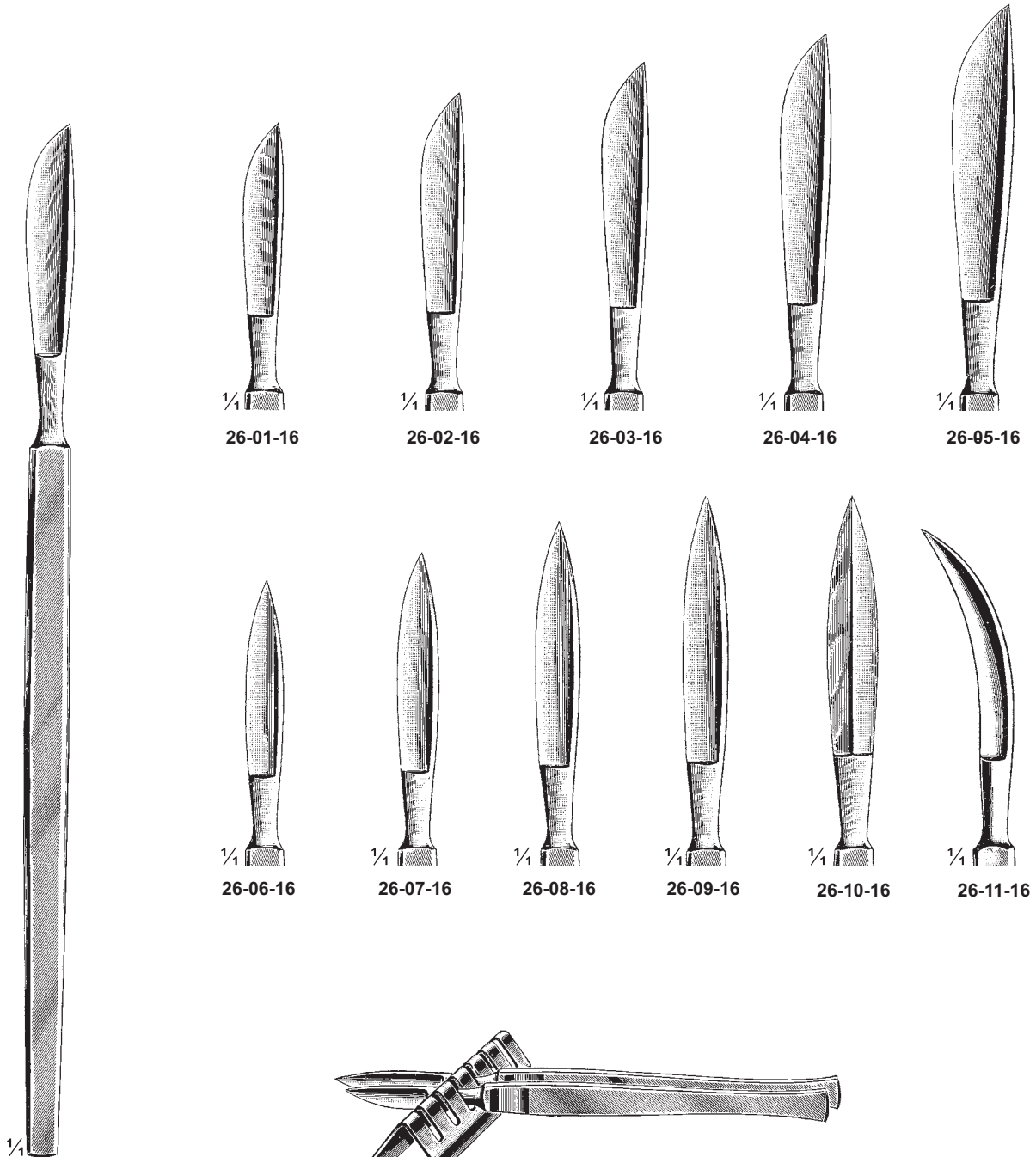

Dieffenbach  
26-01-16 To 26-11-16  
16 cm / 6 1/4"

26-12-06 For 6 Pcs  
26-13-09 For 9 Pcs  
26-14-12 For 12 Pcs  
Rack only

**Anatomische Skalpel  
Scalpel Handles  
Bistouris à dissection**

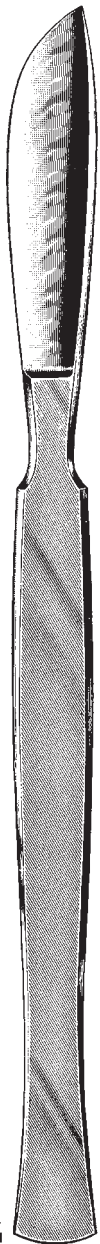

**27-06-16**

**27-01-16 To 27-10-16**  
16.5 cm / 6½"



**27-01-16**



**27-02-16**



**27-03-16**



**27-04-16**

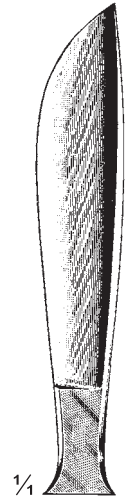

**27-05-16**



**27-07-16**



**27-08-16**



**27-09-16**



**27-10-16**



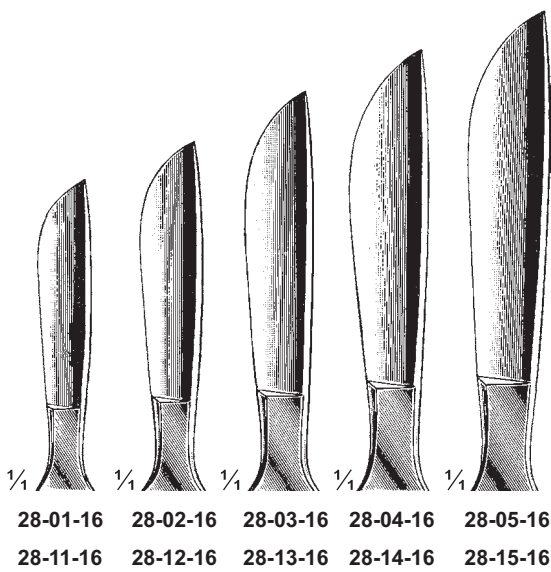

1/4 28-01-16 28-02-16 28-03-16 28-04-16 28-05-16  
28-11-16 28-12-16 28-13-16 28-14-16 28-15-16

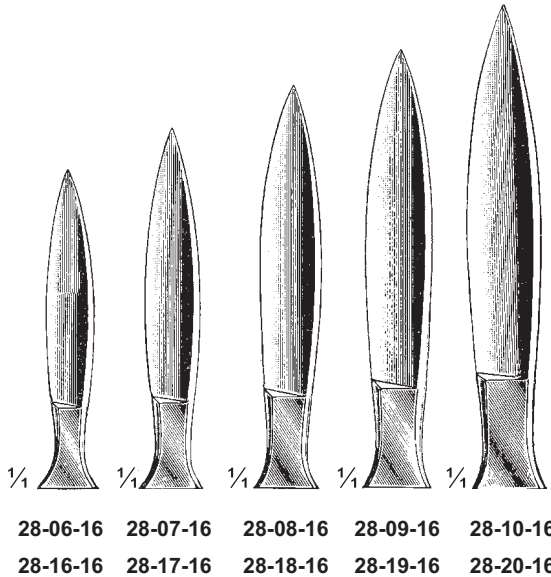

1/4 28-06-16 28-07-16 28-08-16 28-09-16 28-10-16  
28-16-16 28-17-16 28-18-16 28-19-16 28-20-16

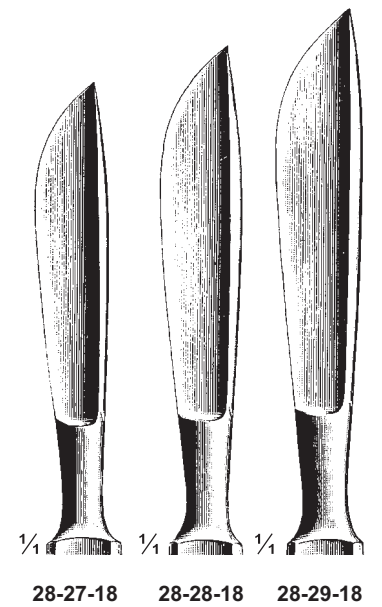
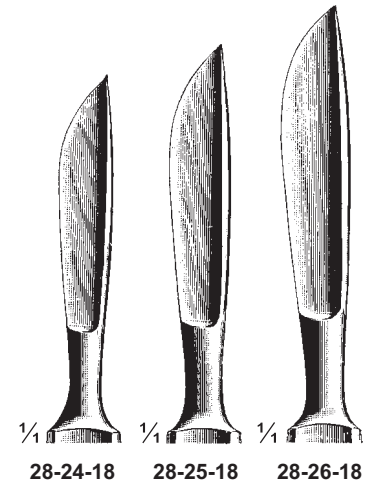
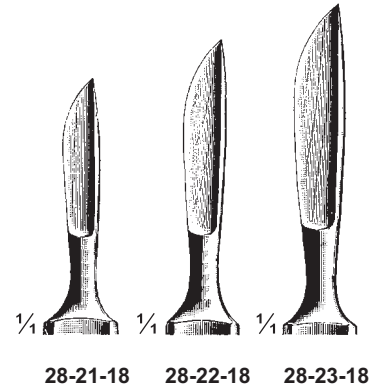

28-01-16 To 28-10-16  
16.5 cm / 6 1/2"  
Wooden handle

28-11-16 To 28-20-16  
16.5 cm / 6 1/2"  
Wooden handle

28-21-18 To 28-29-18  
18 cm / 7"



$\frac{1}{4}$	$\frac{1}{4}$	$\frac{1}{4}$	$\frac{1}{4}$	$\frac{1}{4}$	$\frac{1}{4}$
29-01-18	29-02-18	29-03-18	29-04-18	29-05-18	29-06-18

1,	1,	1,	1,	1,	1,
29-07-18	29-08-18	29-09-18	29-10-18	29-11-18	29-12-18

29-01-18 To 29-19-18  
18 cm / 7"

$\frac{1}{4}$	$\frac{1}{4}$	$\frac{1}{4}$	$\frac{1}{4}$	$\frac{1}{4}$	$\frac{1}{4}$	$\frac{1}{4}$
29-13-18	29-14-18	29-15-18	29-16-18	29-17-18 Tenotome	29-18-18 Tenotome	Halle 29-19-18 19 cm / 7½"

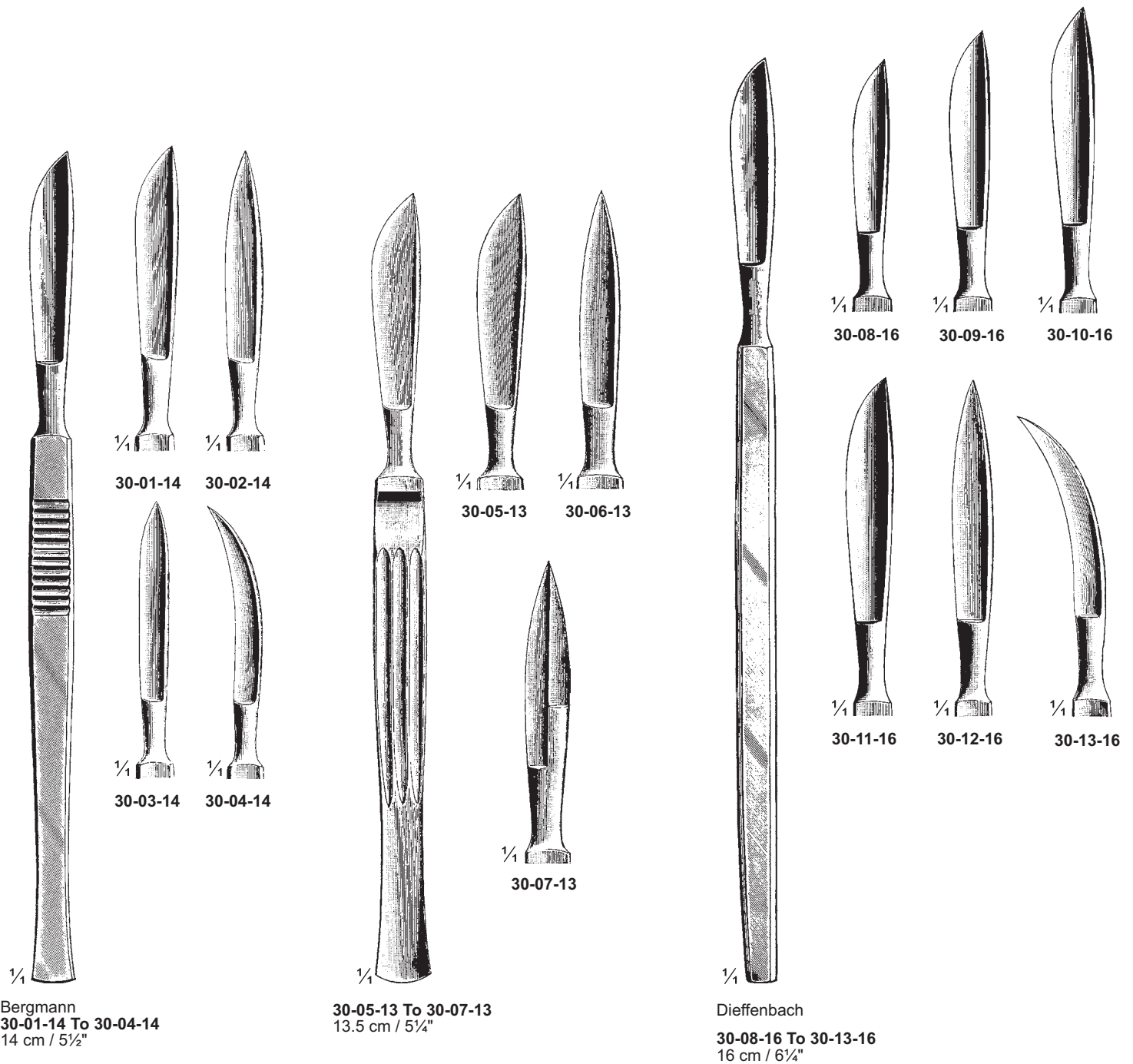

Anatomische Skalpelle  
Scalpel Handles  
Bistouris à dissection

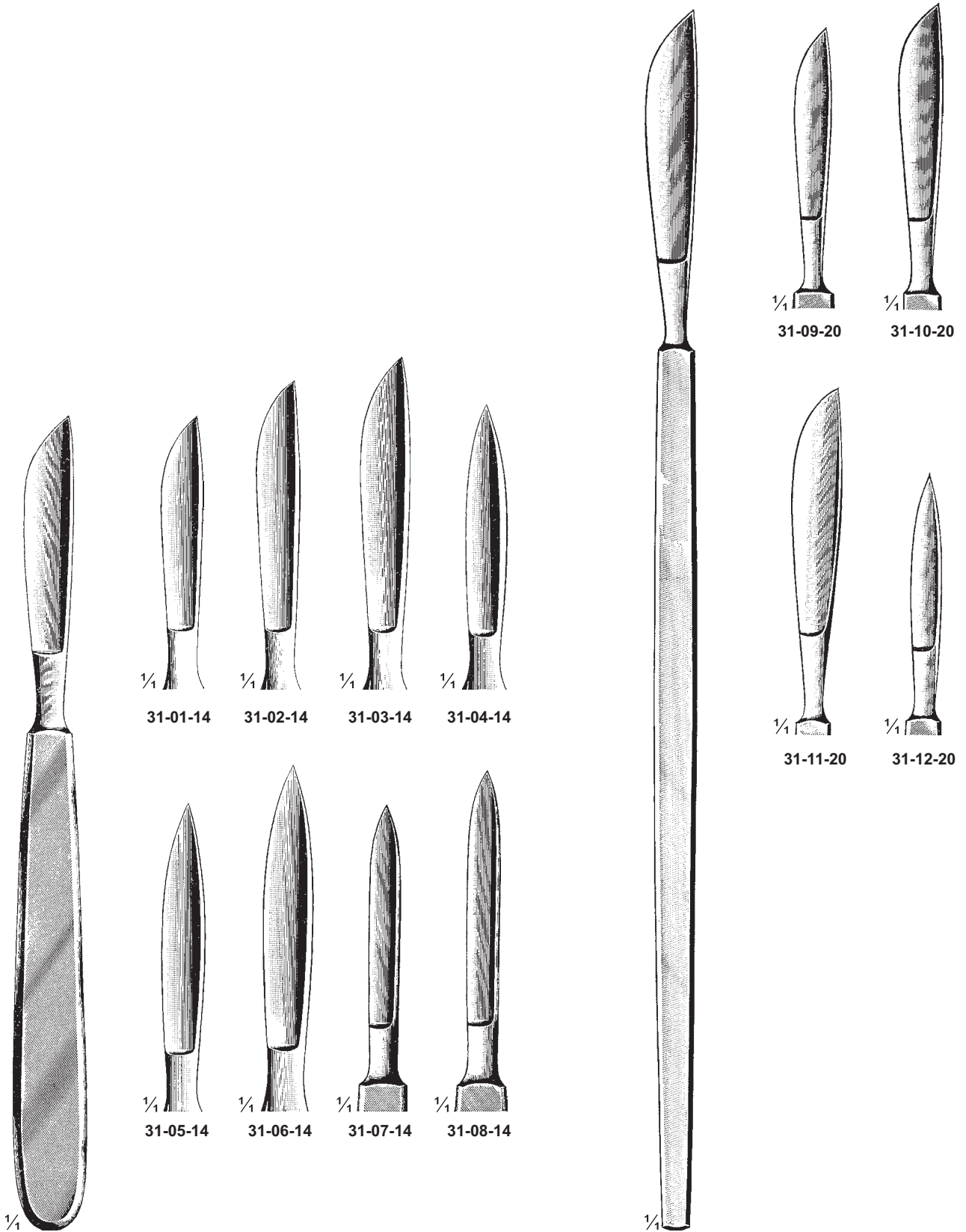

Collin  
31-01-14 To 31-08-14  
14 cm / 5½"

Simon  
31-09-20 To 31-12-20  
20 cm / 8"

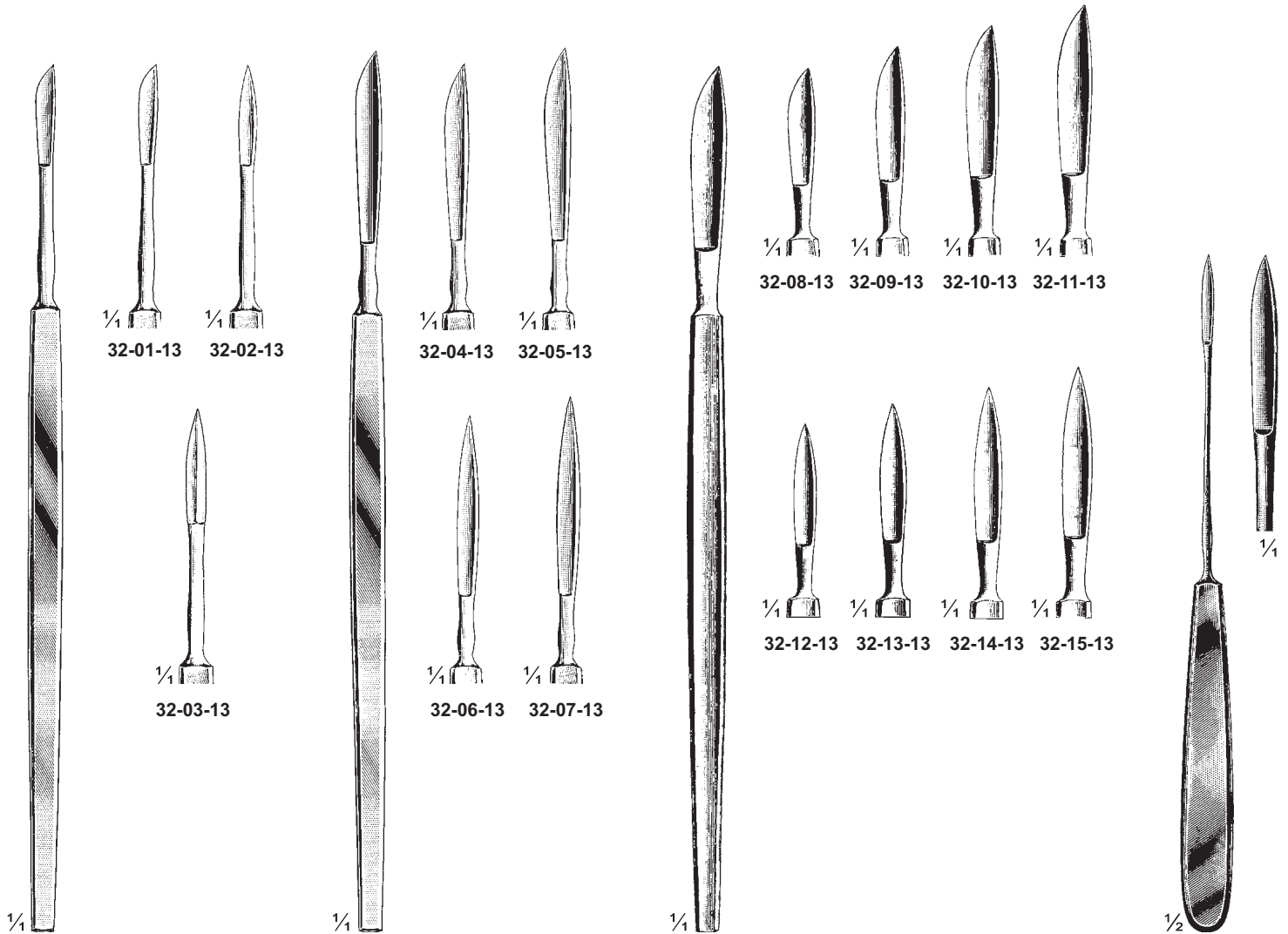

Parker  
32-01-13 To 32-03-13  
13.5 cm / 5 1/4"

Adams  
32-04-13 To 32-07-13  
13.5 cm / 5 1/4"

Dieffenbach  
32-08-13 To 32-15-13  
13 cm / 5 1/8"

Halle  
32-16-21  
21 cm / 8 1/4"  
Dura knife



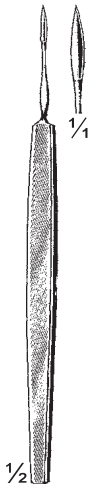

Toennis  
33-01-13  
13 cm / 5 1/4"  
Dura knife

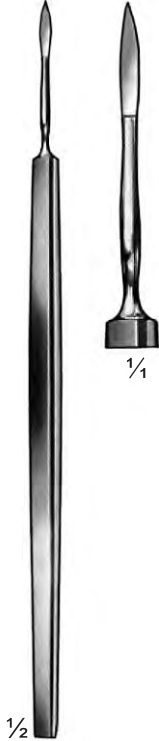

Toennis  
33-02-19  
19 cm / 7 1/2"  
Dura knife



Simon  
33-03-23 To 33-06-23  
23.5 cm / 9 1/4"

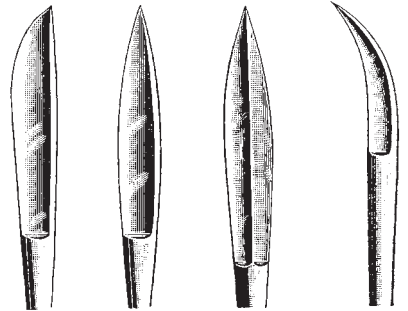

33-03-23 33-04-23 33-05-23 33-06-23

Item No. 33-03-23 To 33-16-23  
Fistula knives



Schroeder  
33-15-22  
22 cm / 8 3/4"

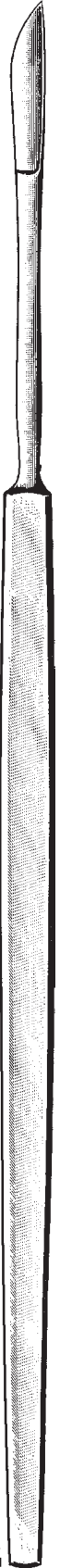

Ulrich  
33-16-22  
22.5 cm / 8 7/8"



Simon  
33-07-20 To 33-10-20  
20 cm / 8"

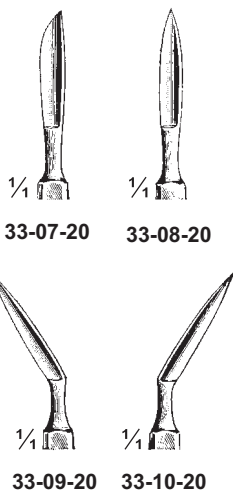

33-07-20 33-08-20  
33-09-20 33-10-20



33-11-22 To 33-13-22  
22.5 cm / 8 7/8"

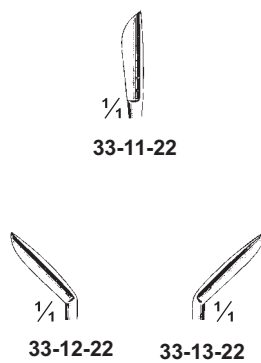

33-11-22

33-12-22 33-13-22



Schroeder  
33-14  
22.5 cm / 8 7/8"

Anatomische Skalpelle  
Scalpel Handles  
Bistouris à dissection

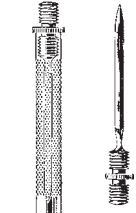

1/2

Sven Hanssen  
34-01-14  
14 cm / 5 1/2"

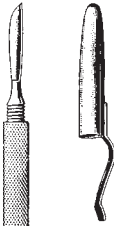

1/2

34-02-12  
12 cm / 4 3/4"

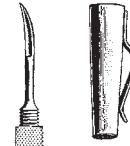

1/2

Vaughan  
34-03-12  
12 cm / 4 3/4"

Item No. 34-01-14 To 34-07-13  
Abscess knives



1/4

34-04-13  
13 cm / 5 1/8"



1/4

34-05-12  
12.5 cm / 5"



1/4

Dieffenbach  
34-06-13  
13 cm / 5 1/8"



1/4

Dieffenbach  
34-07-13  
13 cm / 5 1/8"

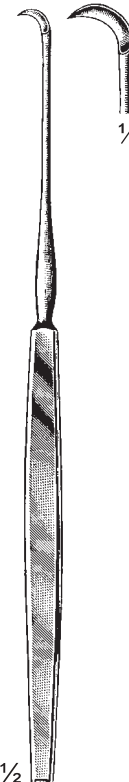

1/2

Olivecrona  
34-08-20  
20 cm / 8"  
Trigeminal  
knife



1/2

Olivecrona  
34-09-23  
23 cm / 9"  
Trigeminal  
knife



**Organmesser  
Post Mortem Knives  
Couteaux à autopsie**



1/2  
Virchow  
36-01-17  
17 cm / 6 3/4"



1/2  
Virchow  
36-02-19  
19 cm / 7 1/2"



1/2  
36-03-19  
19 cm / 7 1/2"



1/2  
Virchow  
36-04-24  
24 cm / 9 1/2"



1/2  
Virchow  
36-05-21  
21 cm / 8 1/4"  
Plastic handle



1/2  
36-06-21  
21 cm / 8 1/4"  
Plastic handle



1/2  
Virchow  
36-07-24  
24 cm / 9 1/2"  
Plastic handle



1/2  
36-08-24  
24 cm / 9 1/2"



1/2  
Virchow  
36-09-21  
21.5 cm / 8 1/2"



1/2

**37-01-23**  
23 cm / 9"  
Plastic handle



1/2

**37-02-25**  
25 cm / 10"

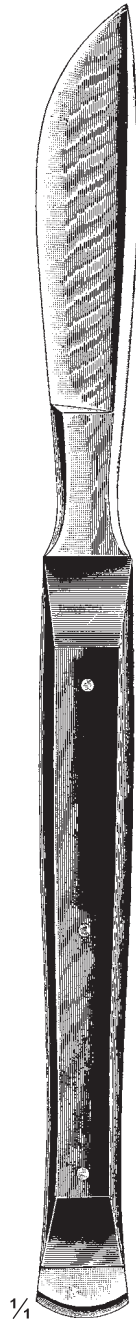

1/4

**37-03-17**  
17.5 cm / 7"  
Plastic handle

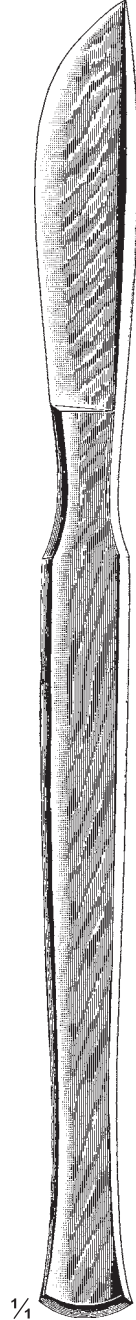

1/4

**37-04-17**  
17.5 cm / 7"



1/4

Langenbeck  
**37-05-17 To 37-07-17**  
17.5 cm / 7"



1/4

**37-05-17**

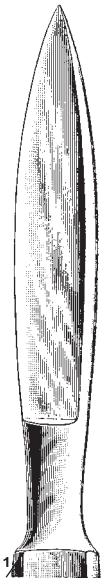

1/4

**37-06-17**

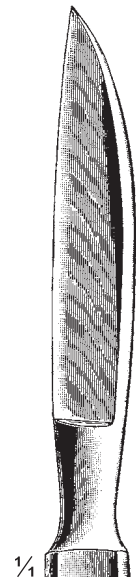

1/4

**37-07-17**





Virchow  
38-01-17  
17 cm / 6 $\frac{3}{4}$ "  
Plastic handle

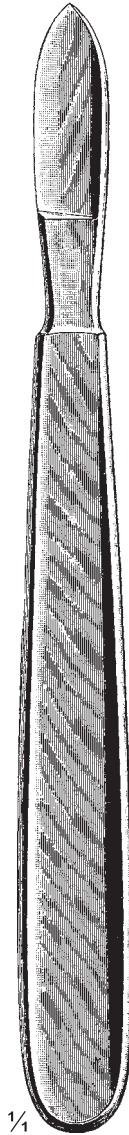

Nelaton  
38-02-14  
14.5 cm / 5 $\frac{3}{4}$ "

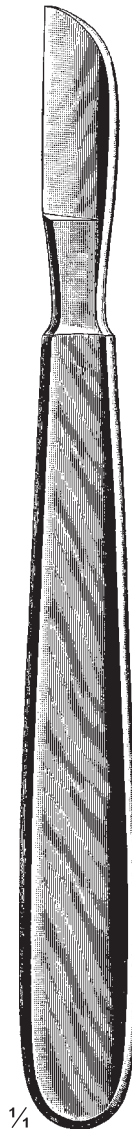

Nelaton  
38-03-14  
14.5 cm / 5 $\frac{3}{4}$ "

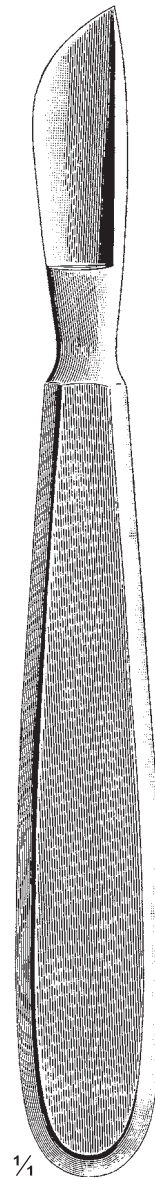

Nelaton  
38-04-15  
15 cm / 6"

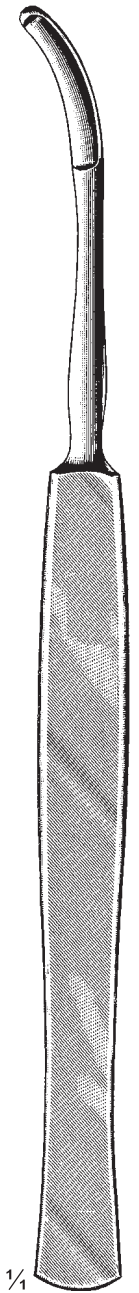

Pott  
38-05-16  
16.5 cm / 6 $\frac{1}{2}$ "



$\frac{1}{2}$   
**39-01-27**  
27 cm / 10½"  
Plastic handle

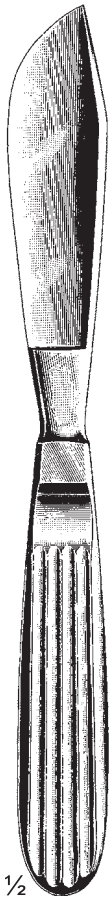

$\frac{1}{2}$   
**39-02-23**  
23 cm / 9"



$\frac{1}{2}$   
**39-03-29**  
29 cm / 11½"



$\frac{1}{2}$   
**39-04-34**  
34 cm / 13½"



$\frac{1}{4}$



$\frac{1}{2}$   
**39-05-23**  
23 cm / 9"  
Plastic handle

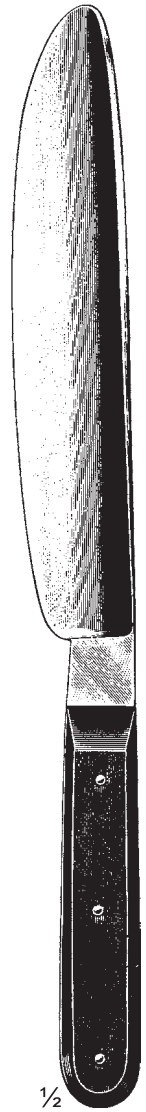

$\frac{1}{2}$   
**39-06-29**  
29 cm / 11½"  
Plastic handle

# Organmesser Post Mortem Knives Couteaux à autopsie

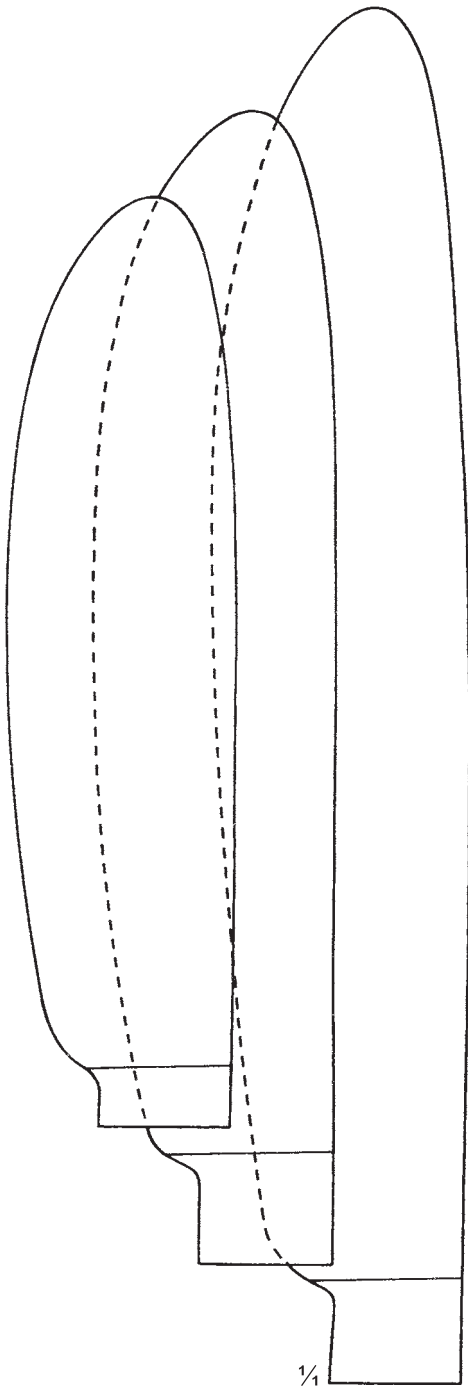

Stainless Handle	Blade Size	Plastic Handle
<b>40-01-11</b>	11.5 cm / 4½"	<b>40-04-11</b>
<b>40-02-13</b>	13.5 cm / 5¼"	<b>40-05-13</b>
<b>40-03-16</b>	16.5 cm / 6½"	<b>40-06-16</b>



Walb  
**40-01-11 To 40-06-16**



Virchow  
**40-07-28**  
28 cm / 11"  
Blade size  
16 cm / 6¼"

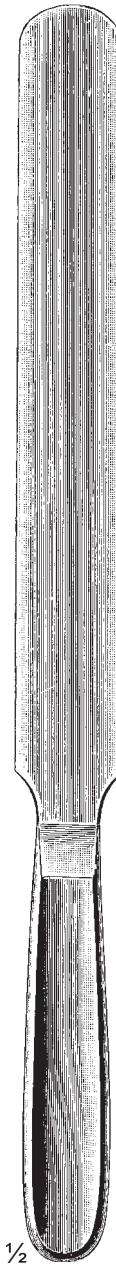

Virchow  
**40-08-32**  
32 cm / 12¾"  
Blade size  
20 cm / 8"

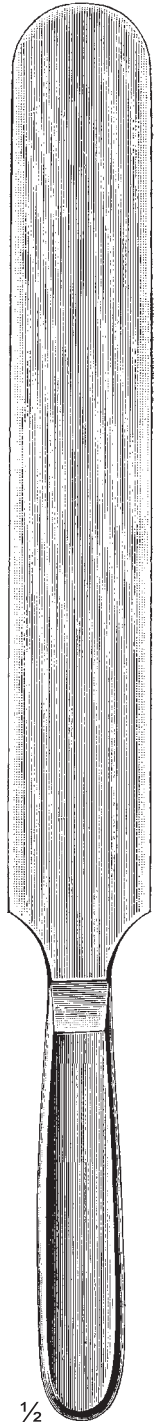

Virchow  
**40-09-36**  
36 cm / 14½"  
Blade size  
24 cm / 9½"

**Amputationsmesser, Rasiermesser, Dermatome  
Amputation Knives, Razor, Skin Grafting Knives  
Couteaux à amputation, Rasoirs, Dermatomes**

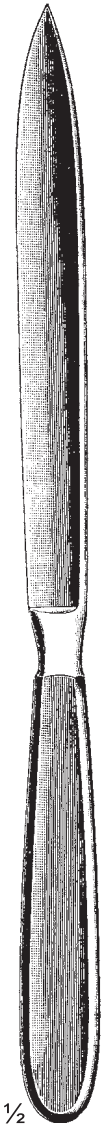

1/2

Liston

	Blade size
41-01-12	12 cm / 4 3/4"
41-02-13	13 cm / 5 1/8"
41-03-14	14 cm / 5 1/2"
41-04-15	15 cm / 6"
41-05-16	16 cm / 6 1/4"
41-06-17	17 cm / 6 3/4"
41-07-18	18 cm / 7"
41-08-19	19 cm / 7 1/2"
41-09-20	20 cm / 8"
41-10-21	21 cm / 8 1/4"
41-11-22	22 cm / 8 3/4"
41-12-23	23 cm / 9"



1/2

Liston

	Blade size
41-13-12	12 cm / 4 3/4"
41-14-13	13 cm / 5 1/8"
41-15-14	14 cm / 5 1/2"
41-16-15	15 cm / 6"
41-17-16	16 cm / 6 1/4"
41-18-17	17 cm / 6 3/4"
41-19-18	18 cm / 7"
41-20-19	19 cm / 7 1/2"
41-21-20	20 cm / 8"
41-22-21	21 cm / 8 1/4"
41-23-22	22 cm / 8 3/4"
41-24-23	23 cm / 9"



1/2

Catlin

	Blade size
41-25-12	12 cm / 4 3/4"
41-26-13	13 cm / 5 1/8"
41-27-14	14 cm / 5 1/2"
41-28-15	15 cm / 6"
41-29-16	16 cm / 6 1/4"
41-30-17	17 cm / 6 3/4"
41-31-18	18 cm / 7"
41-32-19	19 cm / 7 1/2"
41-33-20	20 cm / 8"
41-34-21	21 cm / 8 1/4"
41-35-22	22 cm / 8 3/4"
41-36-23	23 cm / 9"

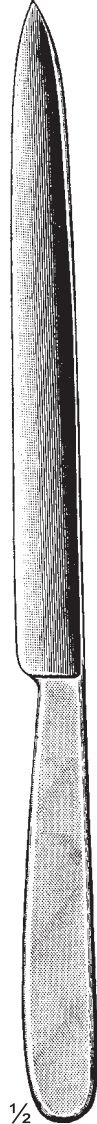

1/2

Collin

	Blade size
41-37-12	12 cm / 4 3/4"
41-38-13	13 cm / 5 1/8"
41-39-14	14 cm / 5 1/2"
41-40-15	15 cm / 6"
41-41-16	16 cm / 6 1/4"
41-42-17	17 cm / 6 3/4"
41-43-18	18 cm / 7"
41-44-19	19 cm / 7 1/2"
41-45-20	20 cm / 8"
41-46-21	21 cm / 8 1/4"
41-47-22	22 cm / 8 3/4"
41-48-23	23 cm / 9"

**Amputationsmesser, Rasiermesser, Dermatome  
Amputation Knives, Razor, Skin Grafting Knives  
Couteaux à amputation, Rasoirs, Dermatomes**

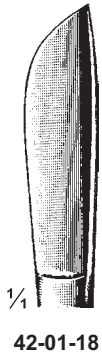

42-01-18

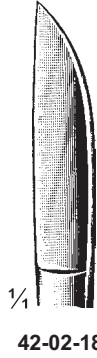

42-02-18

Simon  
42-01-18 & 42-02-18  
18 cm / 7"



Collin  
Blade size  
42-03-12 12 cm / 4<sup>3</sup>/<sub>4</sub>"  
42-04-15 15 cm / 6"  
42-05-17 17 cm / 6<sup>3</sup>/<sub>4</sub>"



Langenbeck  
Blade size  
42-06-13 13 cm / 5<sup>1</sup>/<sub>8</sub>"  
42-07-15 15 cm / 6"  
42-08-18 18 cm / 7"  
42-09-20 20 cm / 8"

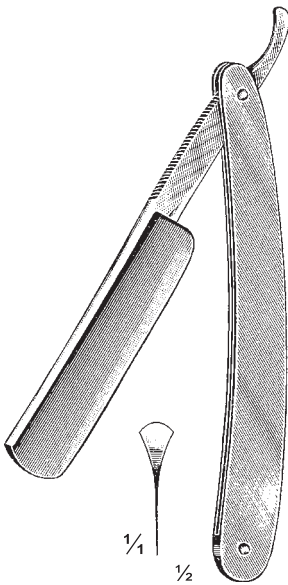

42-10-07  
Blade size  
7.5 cm / 3"  
Both sides concave

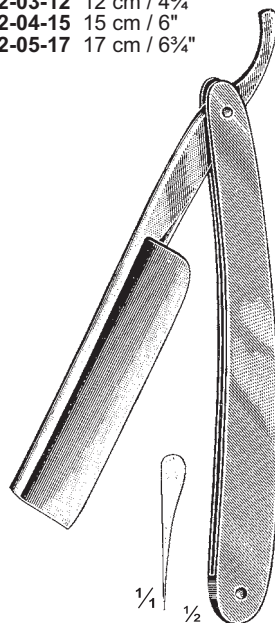

42-11-08  
Blade size  
8 cm / 3<sup>1</sup>/<sub>4</sub>"  
One side concave

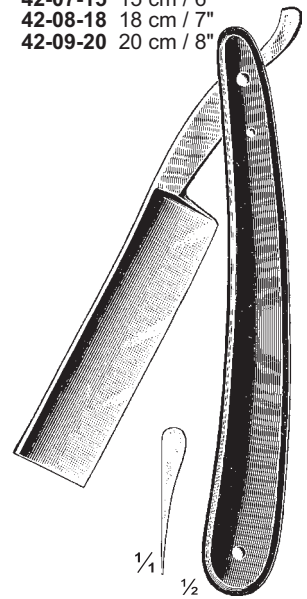

42-12-08  
Blade size  
8 cm / 3<sup>1</sup>/<sub>4</sub>"  
One side concave



**Amputationsmesser, Rasiermesser, Dermatome**  
**Amputation Knives, Razor, Skin Grafting Knives**  
**Couteaux à amputation, Rasoirs, Dermatomes**



1/2

Schink  
**43-01-30**  
 30 cm / 12"



1/2

**43-02-10**  
 10 cm / 4"  
 Spare blade

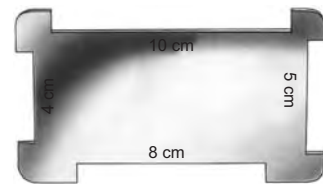

**43-03-00**  
 Skin straightening plate only

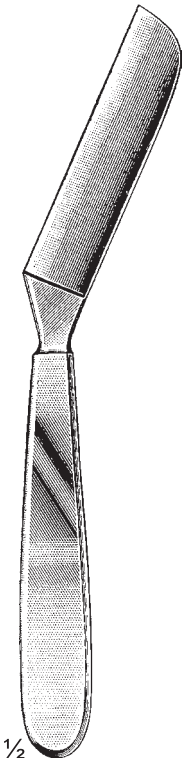

1/2

Thiersch  
**43-04-20**  
 20 cm / 8"

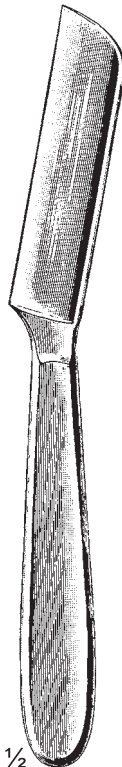

1/2

Thiersch  
**43-05-20**  
 20.5 cm / 8 1/8"

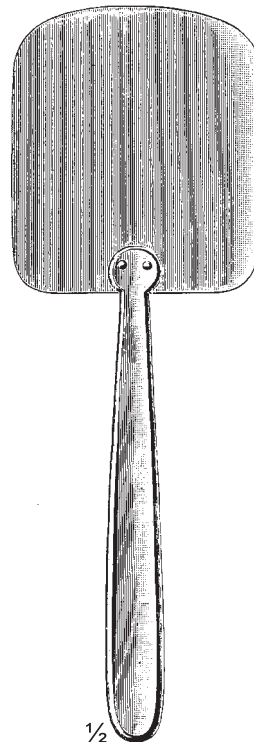

1/2

Mayo  
**43-06-20**  
 20 cm / 8"

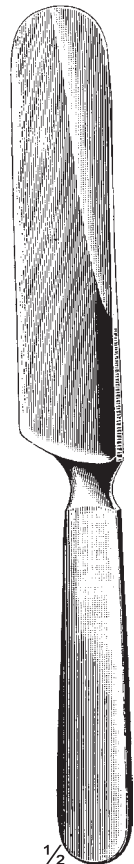

1/2

Rehn  
**43-07-23**  
 23.5 cm / 9 1/4"

# Feine Präparierscheren Delicate Scissors Ciseaux fins à dissection

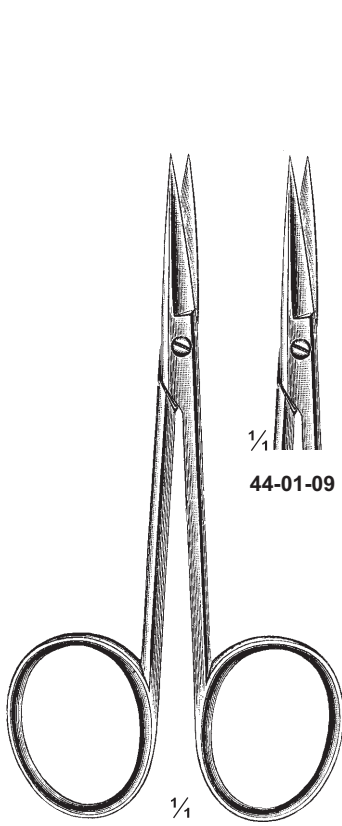

Iris  
44-01-09 & 44-02-09  
9 cm / 3½"

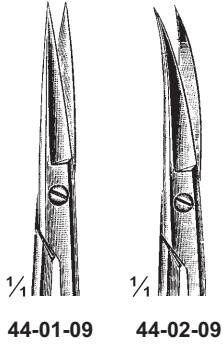

¼  
¼  
44-01-09 44-02-09

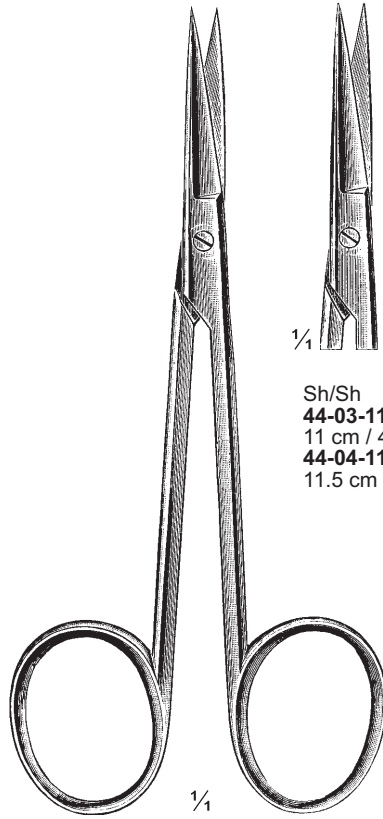

Iris  
44-03-11 To 44-10-11

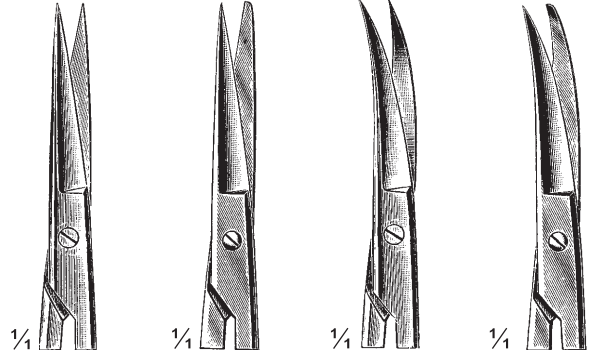

¼	¼	¼	¼
Sh/Sh 44-03-11 11 cm / 4¼"	Sh/Bl 44-05-11 11 cm / 4¼"	Sh/Sh 44-07-11 11 cm / 4¼"	Sh/Bl 44-09-11 11 cm / 4¼"
44-04-11 11.5 cm / 4½"	44-06-11 11.5 cm / 4½"	44-08-11 11.5 cm / 4½"	44-10-11 11.5 cm / 4½"



¼  
Sh/Sh  
44-11-11  
11 cm / 4¼"  
44-12-11  
11.5 cm / 4½"



¼  
Sh/Sh  
44-13-11  
11 cm / 4¼"  
44-14-11  
11.5 cm / 4½"



¼  
Sh/Bl  
44-15-11  
11 cm / 4¼"  
44-16-11  
11.5 cm / 4½"

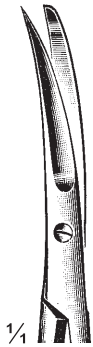

¼  
Sh/Bl  
44-17-11  
11 cm / 4¼"  
44-18-11  
11.5 cm / 4½"

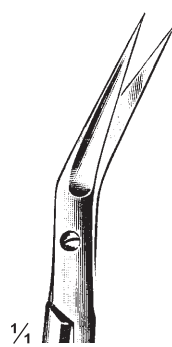

¼  
Sh/Sh, Angular  
44-19-11  
11 cm / 4¼"  
44-20-11  
11.5 cm / 4½"

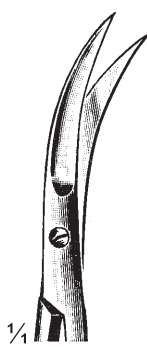

¼  
Sh/Sh, Sideways Cur  
44-21-11  
11 cm / 4¼"  
44-22-11  
11.5 cm / 4½"

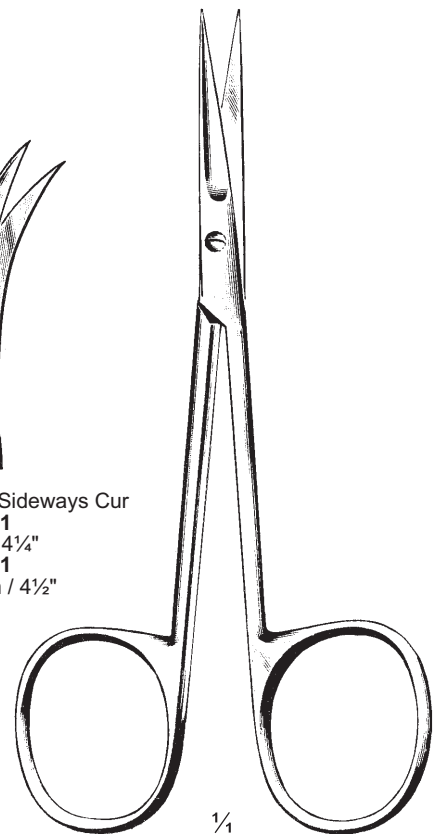

Iris  
44-11-11 To 44-22-11

# Feine Präparierscheren Delicate Scissors Ciseaux fins à dissection

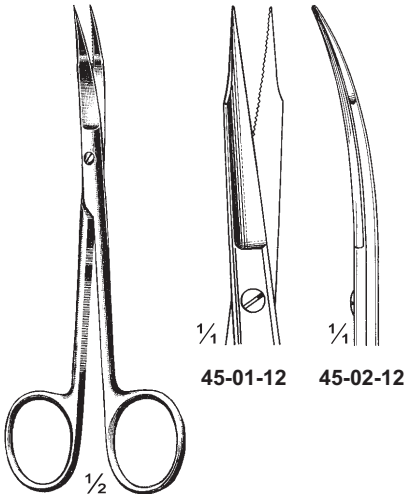

Goldman-Fox  
45-01-12 & 45-02-12  
12.5 cm / 5"  
One blade serrated

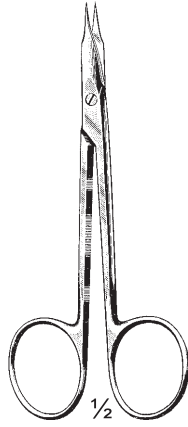

Stevens  
45-03-11 To 45-06-11  
11 cm / 4 1/4"

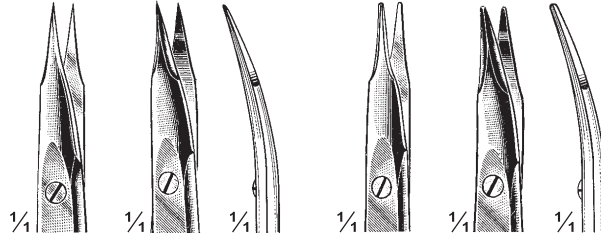

45-04-11  
45-08-11  
Sh/Sh

45-03-11  
45-07-11  
Sh/Sh

45-05-11  
45-09-11  
BI/BI

45-06-11  
45-10-11  
BI/BI

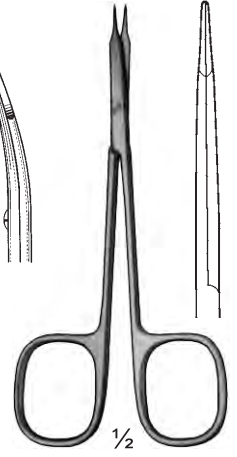

Stevens  
45-07-11 To 45-10-11  
11.5 cm / 4 1/2"

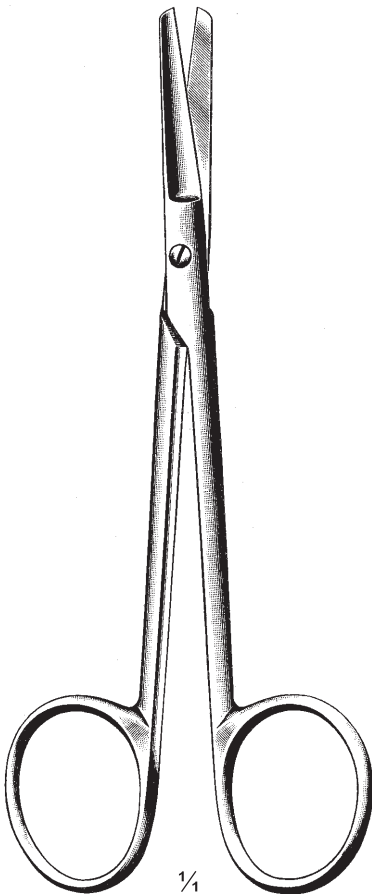

45-11-12  
12 cm / 4 3/4"

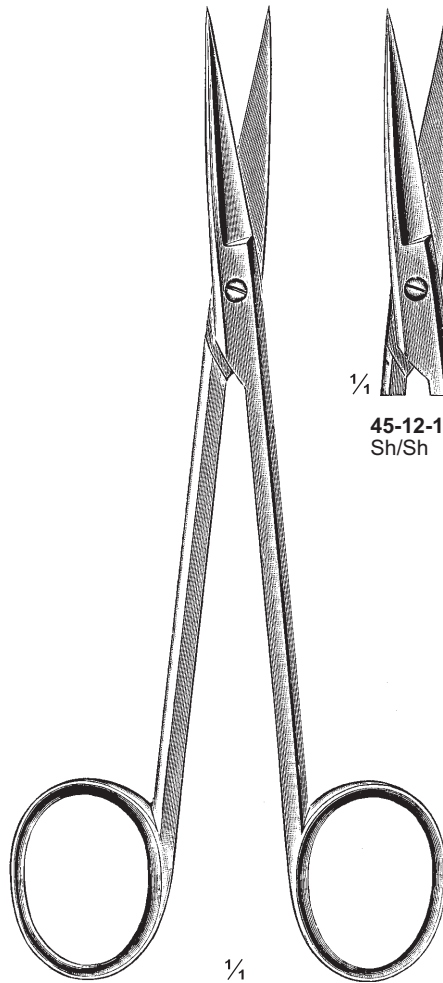

45-12-13 To 45-15-13  
13 cm / 5 1/8"

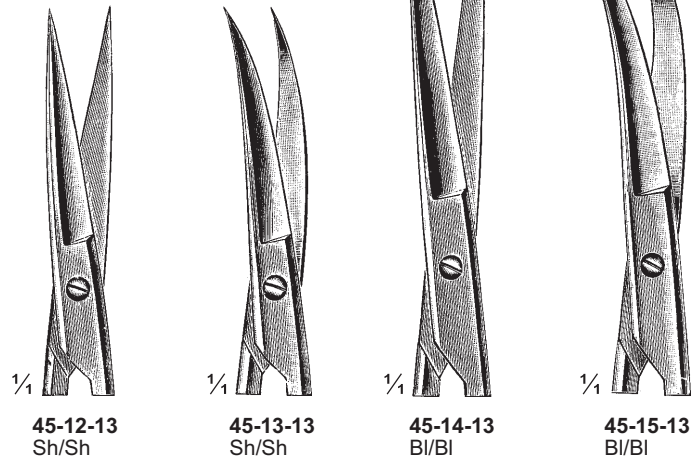

45-12-13  
Sh/Sh

45-13-13  
Sh/Sh

45-14-13  
BI/BI

45-15-13  
BI/BI

**Feine Präparierscheren**  
**Delicate Scissors**  
**Ciseaux fins à dissection**

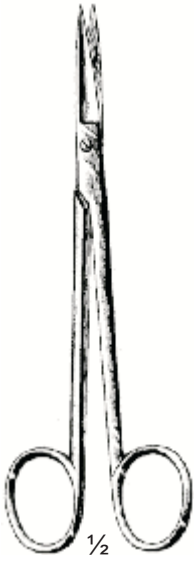

Joseph  
**46-01-14**  
 14 cm / 5½"

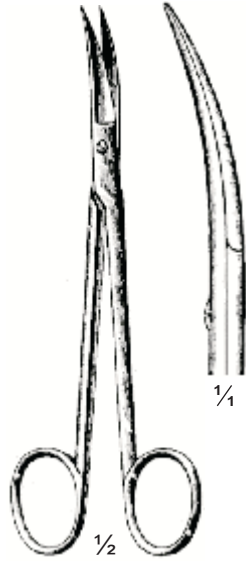

Joseph  
**46-02-14**  
 14 cm / 5½"

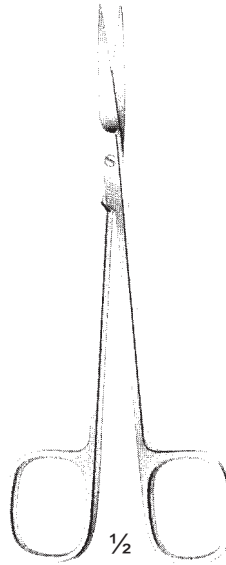

Joseph  
**46-03-15 & 46-04-15**  
 15 cm / 6"



**46-03-15**

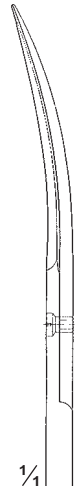

**46-04-15**

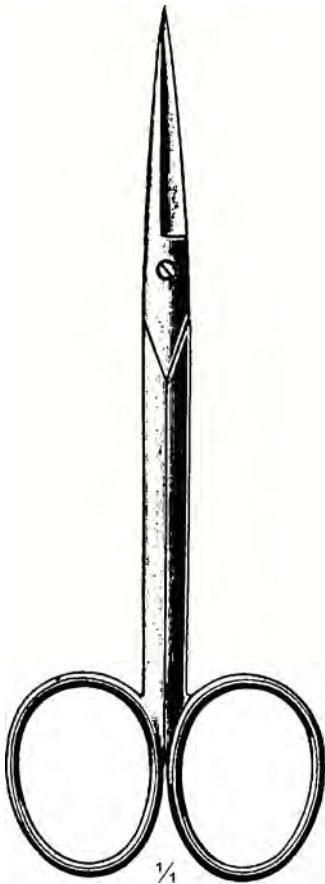

Iris  
**46-05-11** 11.5 cm / 4½" Str  
**46-06-11** 11.5 cm / 4½" Cur

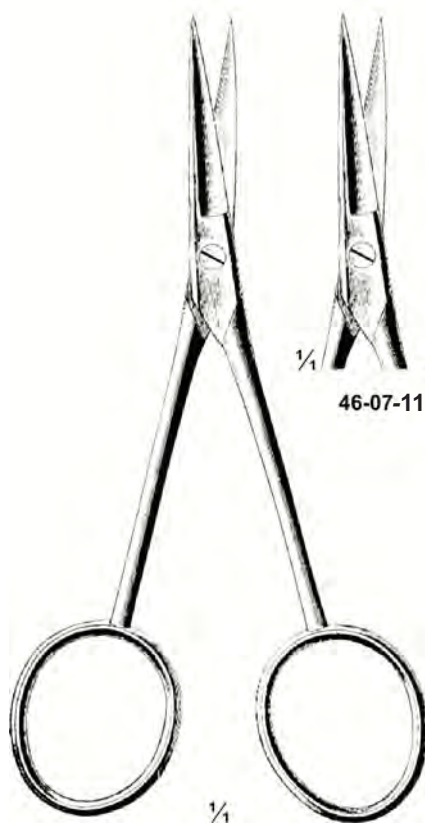

Dissecting  
**46-07-11 & 46-08-11**  
 11 cm / 4¼"



**46-07-11**

**46-08-11**

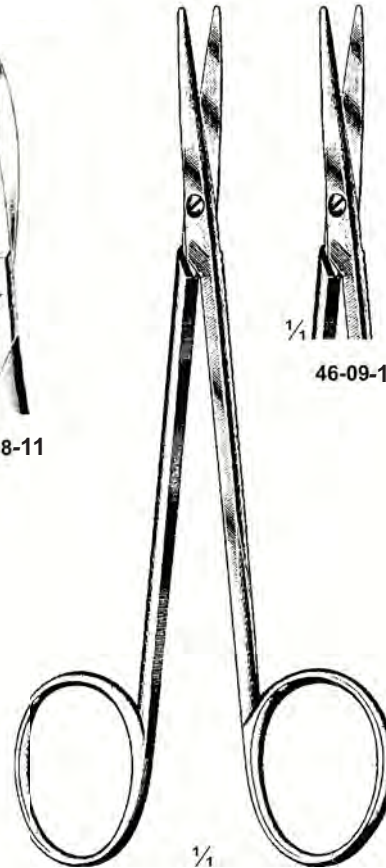

**46-09 & 46-10**  
 11.5 cm / 4½"

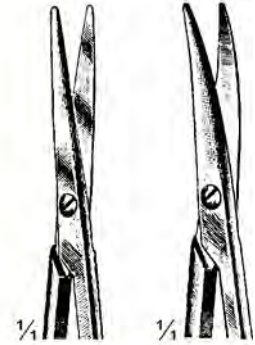

**46-09-11**

**46-10-11**

**Feine Präparierscheren  
Delicate Scissors  
Ciseaux fins à dissection**

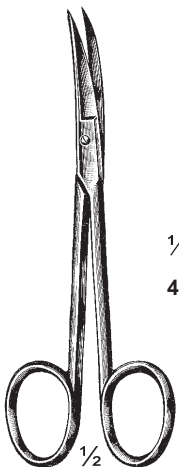

Wagner  
47-01-12 & 47-02-12  
12 cm / 4¾"

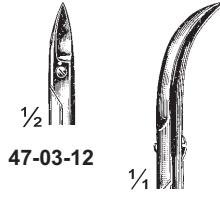
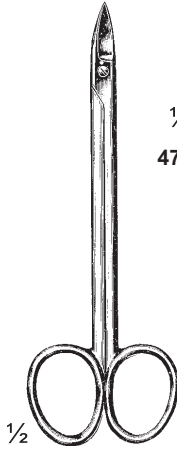

Quinby  
47-03-12 & 47-04-12  
12 cm / 4¾"

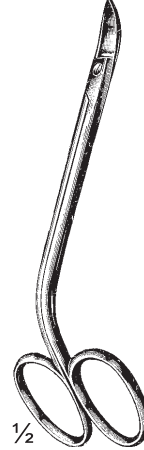

Neumann  
47-05-12  
12 cm / 4¾"

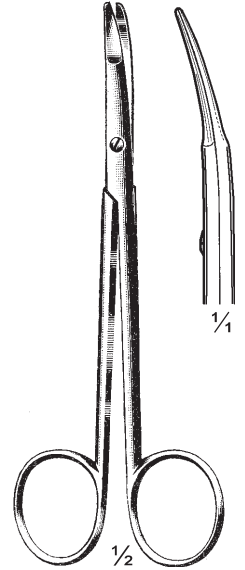

Kilner  
47-06-12 12 cm / 4¾"  
47-07-12 15 cm / 6"

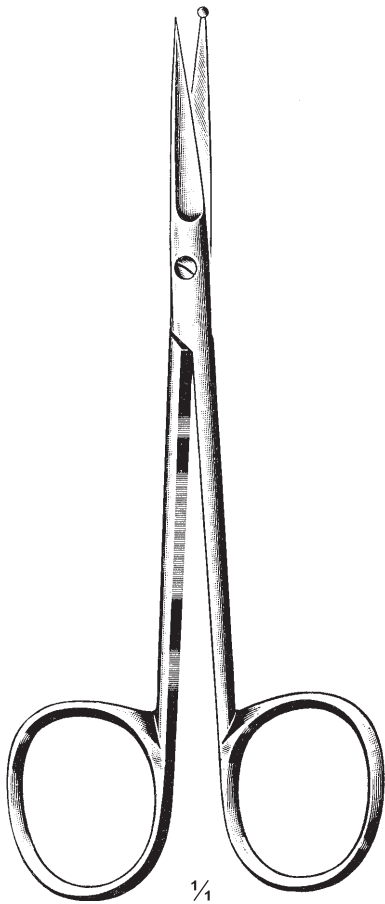

Maunoir  
47-08-11  
11.5 cm / 4½"  
Sh/Probe

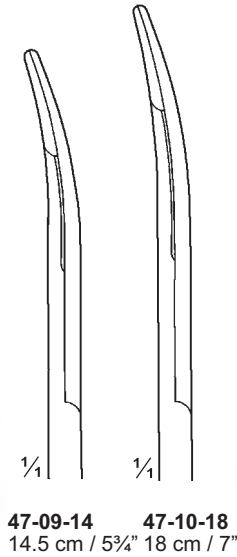
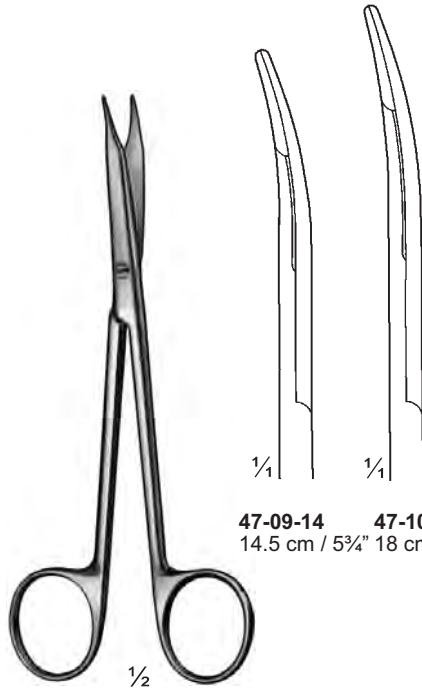

Reynolds  
47-09-14 & 47-10-18  
14.5 cm / 5¾" 18 cm / 7"

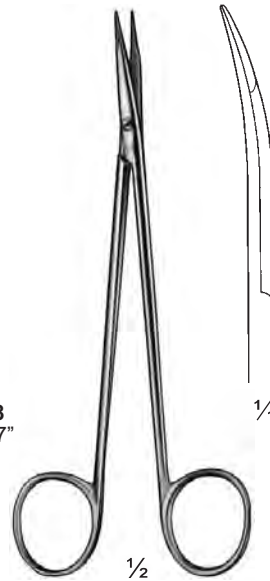

Jameson  
47-11-15  
15 cm / 6"

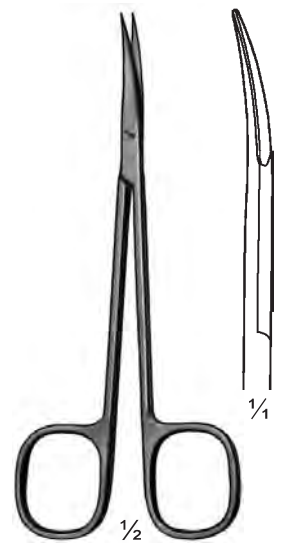

Reynolds-Jameson  
47-12-14  
14 cm / 5½"



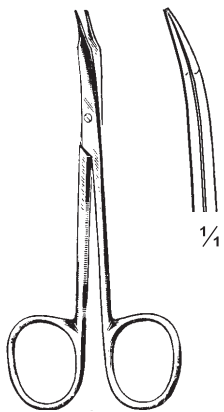

Enucleation  
48-01-11  
11 cm / 4 1/4"

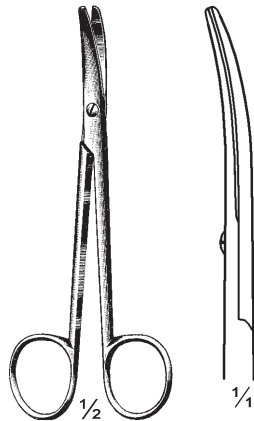

Micro Stevens  
48-02-11 11 cm / 4 1/4" Str  
48-03-11 11 cm / 4 1/4" Cur

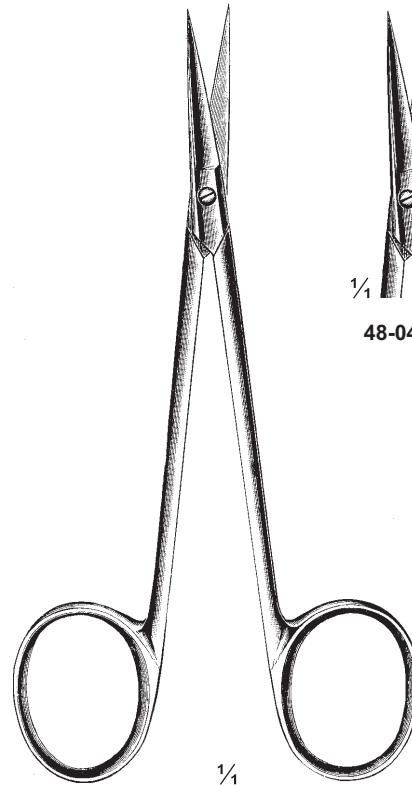

Iris  
48-04-11 & 48-05-11  
11 cm / 4 1/4"

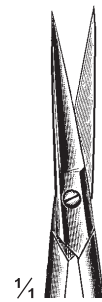

48-04-11

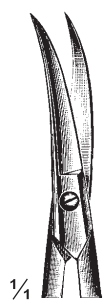

48-05-11

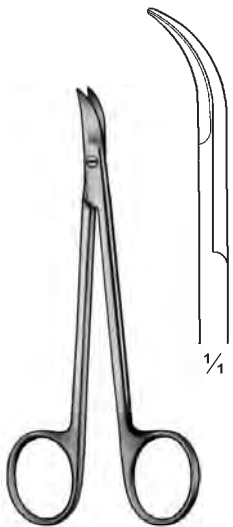

Chadwick  
48-06-11  
11.5 cm / 4 1/2"

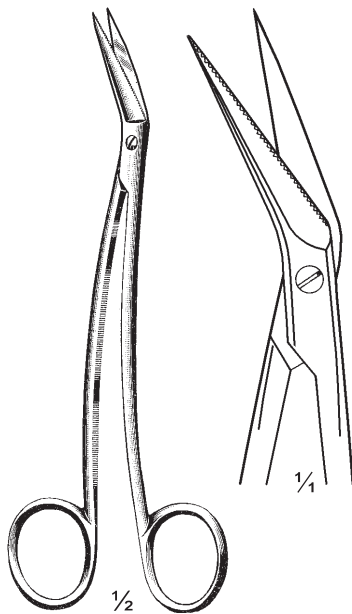

Locklin  
48-07-16  
16 cm / 6 1/4"  
One blade serrated



Kelly  
48-08-14 To 48-13-18



48-08-14  
14.5 cm / 5 3/4"  
48-09-16  
16 cm / 6 1/4"



48-10-18  
18 cm / 7"



48-11-14  
14.5 cm / 5 3/4"  
48-12-16  
16 cm / 6 1/4"

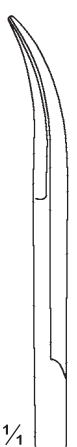

48-13-18  
18 cm / 7"

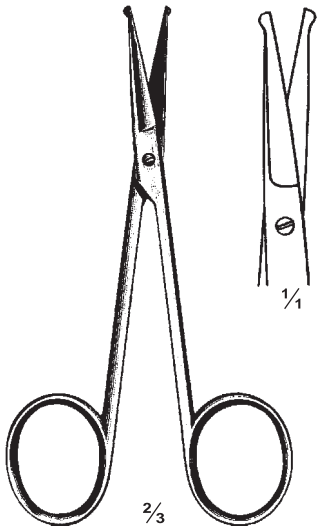

**49-01-10**  
 10.5 cm / 4 1/8"

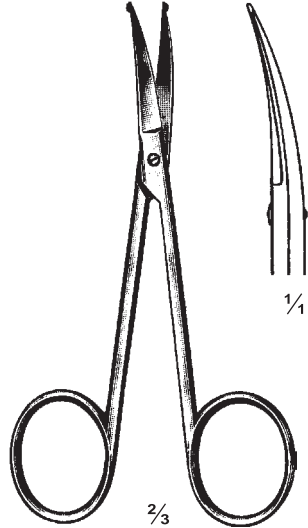

**49-02-10**  
 10.5 cm / 4 1/8"

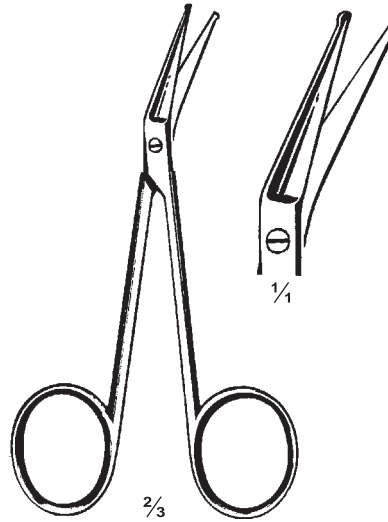

**49-03-10**  
 10.5 cm / 4 1/8"

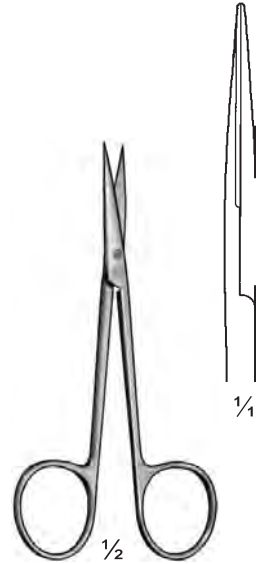

Kilner  
**49-04-11**  
 11.5 cm / 4 1/2"

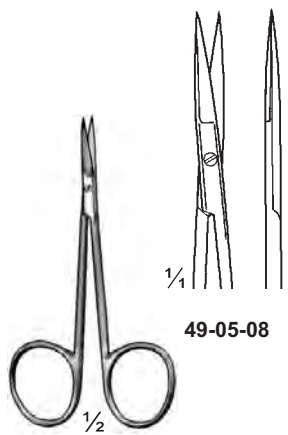

**49-05-08**



**49-06-08**

**49-05-08 & 49-06-08**  
 8 cm / 3 1/4"

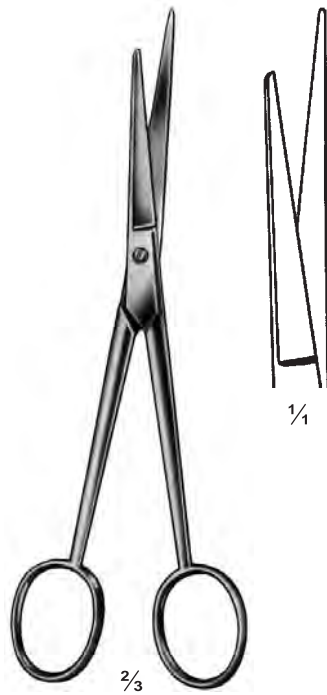

**49-07-14**  
 14.5 cm / 5 3/4"  
 Without probe



**49-08-14**  
 14.5 cm / 5 3/4"  
 Sh/Probe

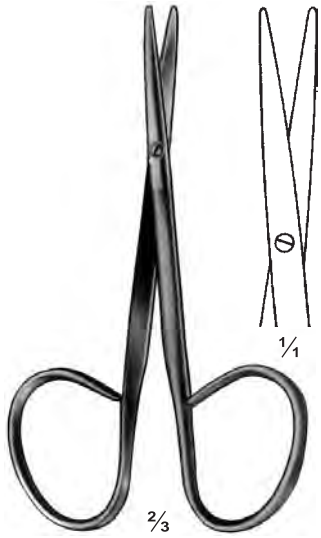

50-01-10  
10 cm / 4"

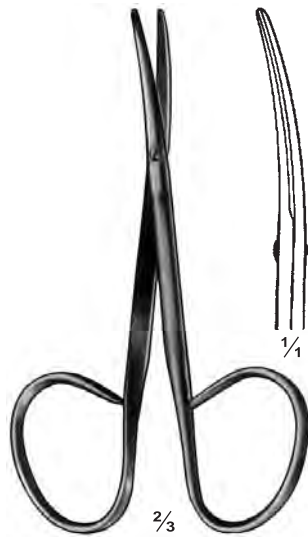

50-02-10  
10 cm / 4"

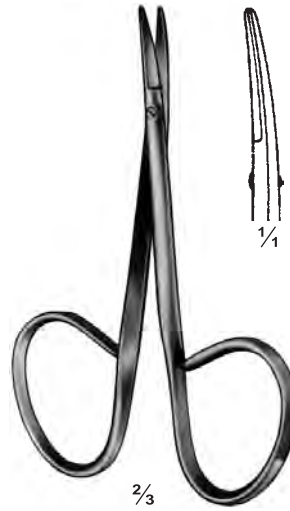

50-03-09  
9.5 cm / 3¾"

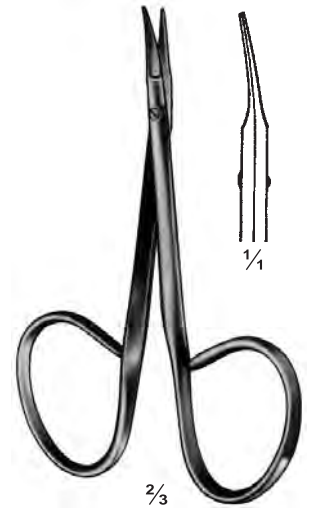

50-04-09  
9.5 cm / 3¾"

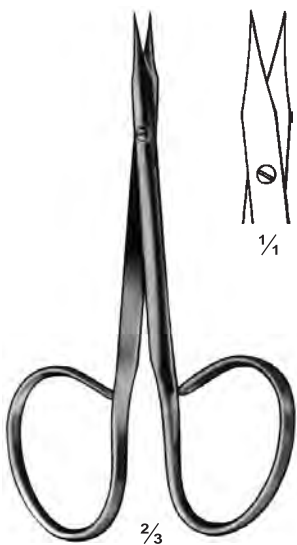

Stevens  
50-05-10  
10 cm / 4"

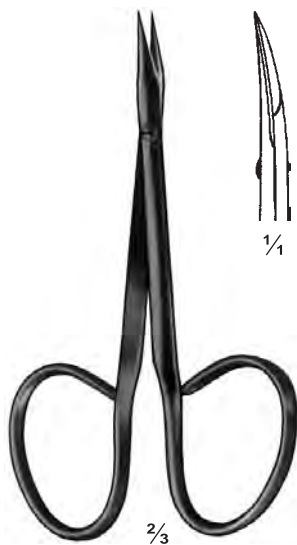

Stevens  
50-06-10  
10 cm / 4"

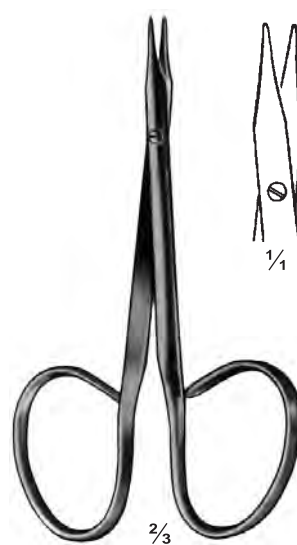

Stevens  
50-07-10  
10 cm / 4"

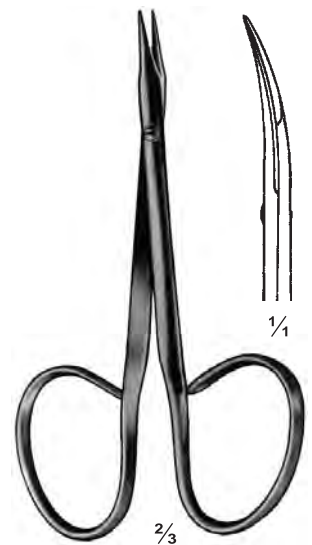

Stevens  
50-08-10  
10 cm / 4"

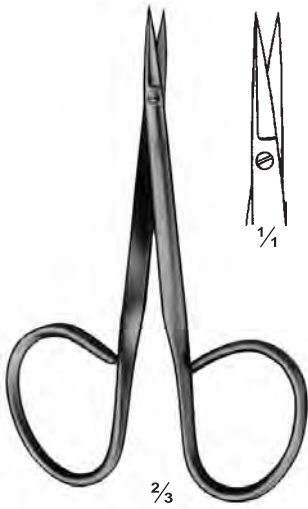

**51-01-09**  
 9.5 cm / 3¾"

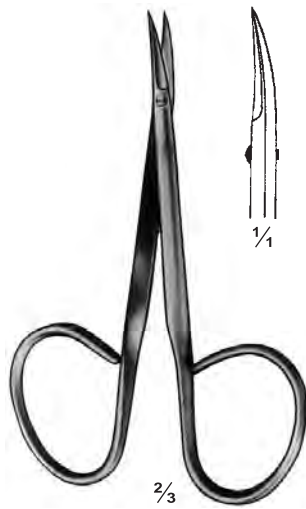

**51-02-09**  
 9.5 cm / 3¾"



**51-03-09**  
 9.5 cm / 3¾"

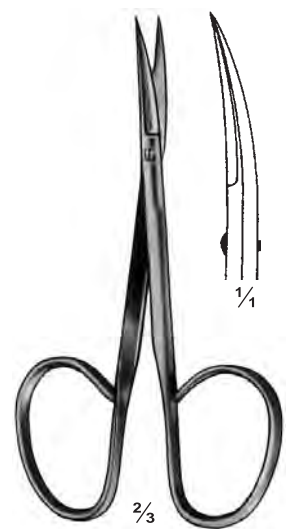

**51-04-09**  
 9.5 cm / 3¾"

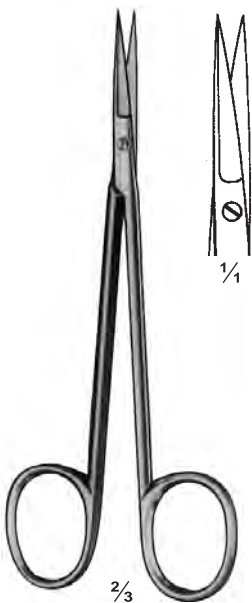

Knapp  
**51-05-12**  
 12 cm / 4¾"



Knapp  
**51-06-12**  
 12 cm / 4¾"



Knapp  
**51-07-12**  
 12 cm / 4¾"

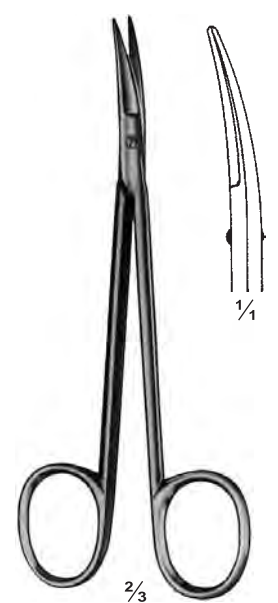

Knapp  
**51-08-12**  
 12 cm / 4¾"

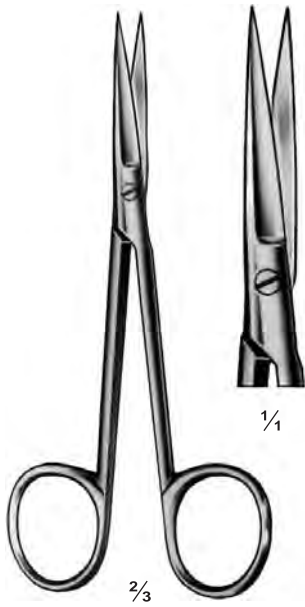

Wagner  
**52-01-12**  
12 cm / 4¾"

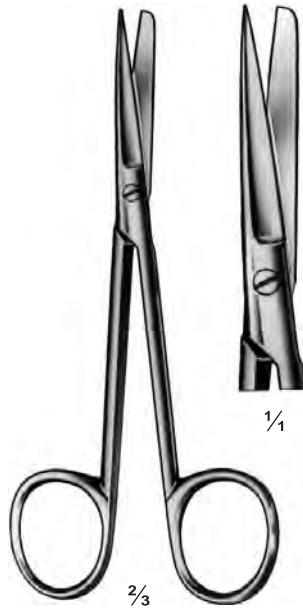

Wagner  
**52-02-12**  
12 cm / 4¾"

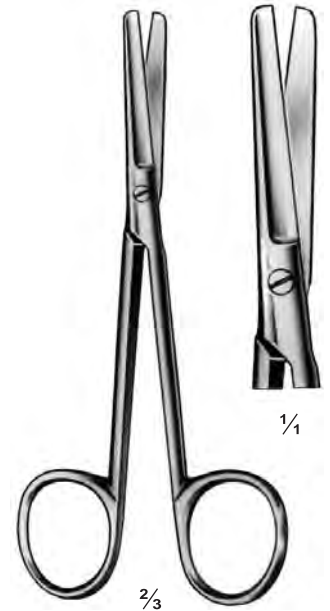

Wagner  
**52-03-12**  
12 cm / 4¾"



Wagner  
**52-04-12**  
12 cm / 4¾"



Wagner  
**52-05-12**  
12 cm / 4¾"



Wagner  
**52-06-12**  
12 cm / 4¾"



# Ligaturscheren Ligature Scissors Ciseaux Pour ligatures

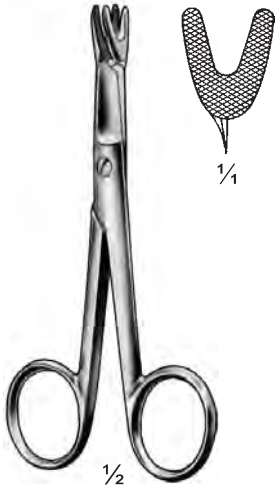

Schoemaker-Loth  
53-01-13  
13 cm / 5 $\frac{1}{8}$ "

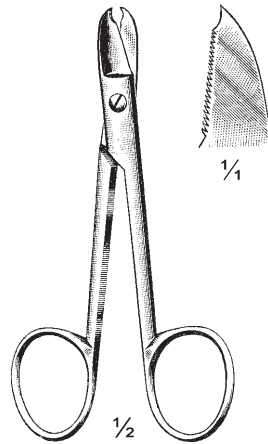

53-02-12  
12 cm / 4 $\frac{3}{4}$ "  
One blade serrated



Eiselsboerg  
53-03-11  
11 cm / 4 $\frac{1}{4}$ "

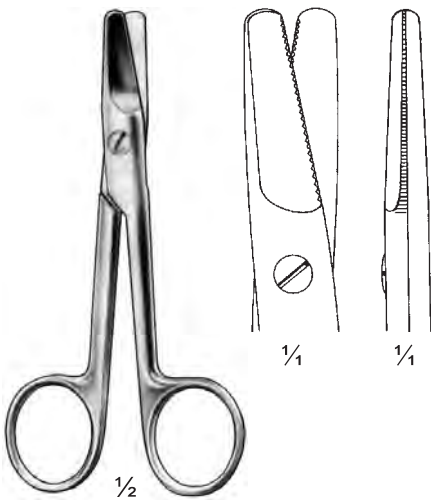

Harvey  
53-04-12  
12.5 cm / 5"  
Both blades serrated

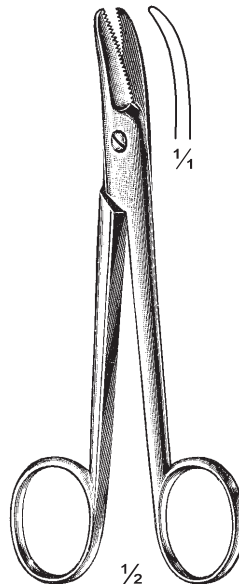

53-05-15  
15.5 cm / 6 $\frac{1}{8}$ "  
Both blade serrated

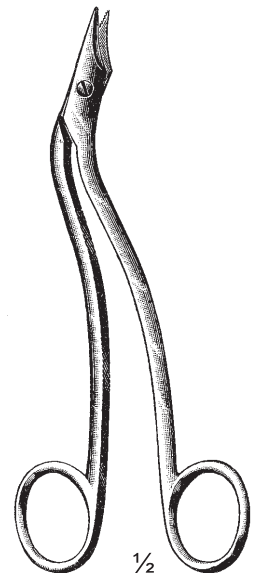

Heath  
53-06-15  
15 cm / 6"  
One blade serrated

**Ligaturscheren  
Ligature Scissors  
Ciseaux Pour ligatures**

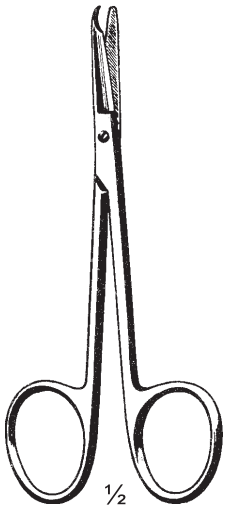

54-01-09 9 cm / 3½"  
54-02-13 13 cm / 5¼"

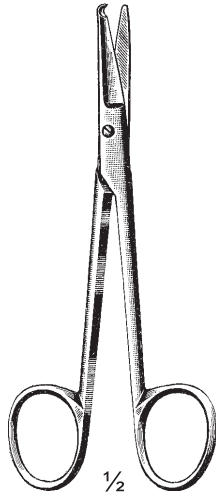

Spencer  
54-03-13  
13 cm / 5¼"

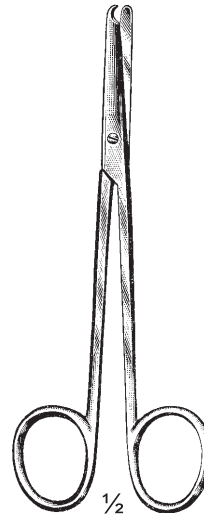

Buck  
54-04-13  
13.5 cm / 5¼"

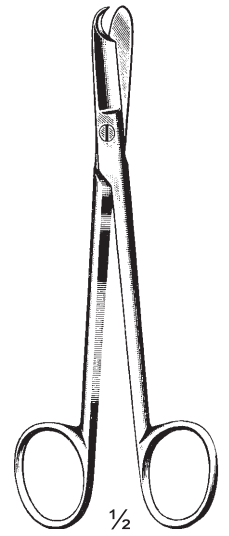

Littauer  
54-05-14  
14 cm / 5½"

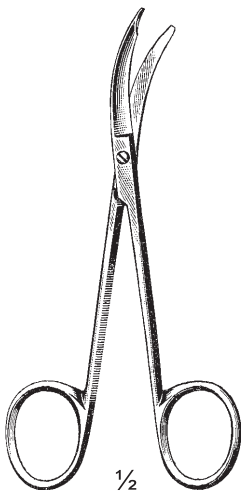

Northbent  
54-06-09 9 cm / 3½"  
54-07-13 13 cm / 5¼"

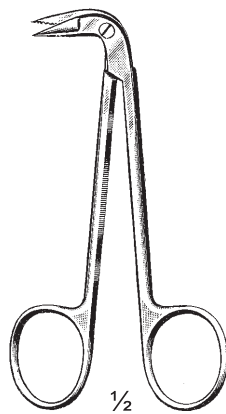

54-08-11  
11 cm / 4¼"  
One blade serrated

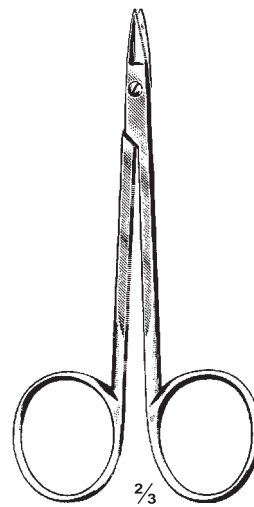

Schuknecht  
54-09-10  
10 cm / 4"  
One blade serrated

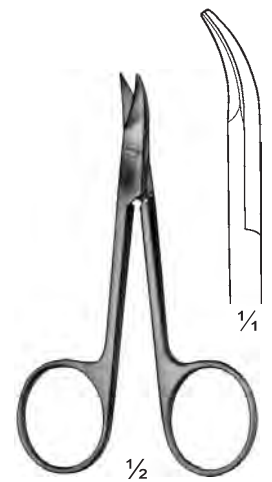

Strack  
54-10-10  
10 cm / 4"

# Ligaturscheren Ligature Scissors Ciseaux Pour ligatures

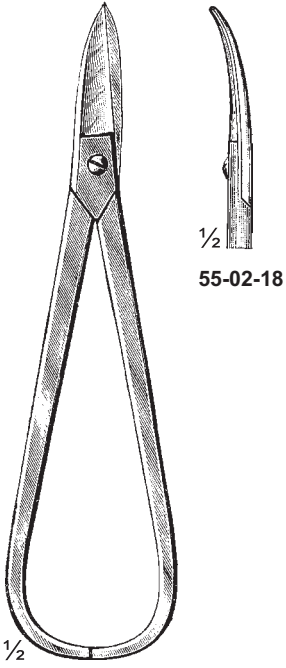

1/2  
55-01-18 Str  
55-01-18 & 55-02-18  
18 cm / 7"  
Wire and plate cutter

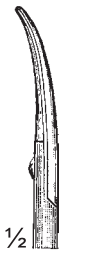

1/2  
55-02-18

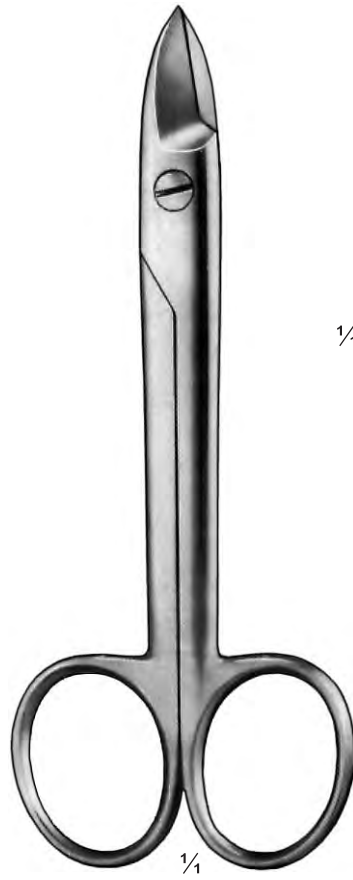

1/4  
Beebee  
55-03-11 To 55-06-11  
11.5 cm / 4 1/2"  
Broad blades



1/4  
55-03-11  
Sh/Sh



1/4  
55-04-11  
Sh/Sh



1/4  
55-05-11  
Sh/Sh  
One blade  
serrated



1/4  
55-06-11  
Sh/Sh  
One blade  
serrated



2/3  
Beebee  
55-07 & 55-08  
12.5 cm / 5"



2/3  
55-07-12  
Sh/Sh



2/3  
55-08-12  
Sh/Sh

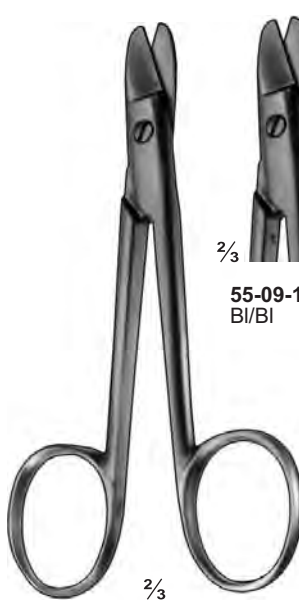

2/3  
Beebee  
55-09 & 55-10  
12.5 cm / 5"



2/3  
55-09-12  
BI/BI



2/3  
55-10-12  
BI/BI

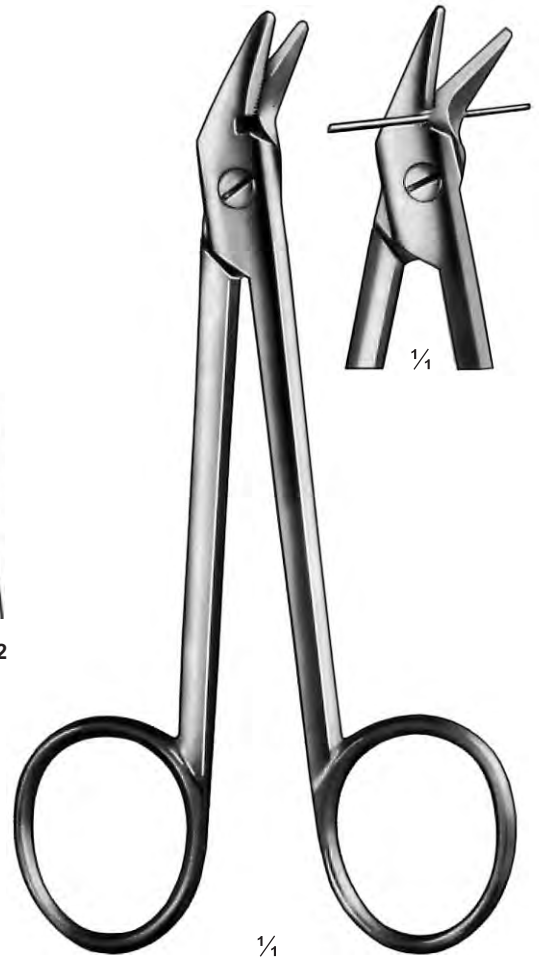

1/1  
55-11-12  
12.5 cm / 5"



1/1

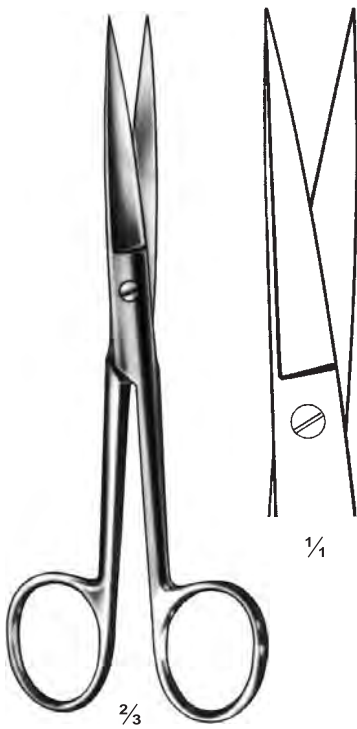

Sh/Sh  
**56-01-10** 10 cm / 4"  
**56-02-11** 11.5 cm / 4½"  
**56-03-12** 12.5 cm / 5"  
**56-04-14** 14 cm / 5½"  
**56-05-14** 14.5 cm / 5¾"  
**56-06-15** 15 cm / 6"  
**56-07-17** 17 cm / 6¾"  
**56-08-18** 18 cm / 7"  
**56-09-20** 20 cm / 8"

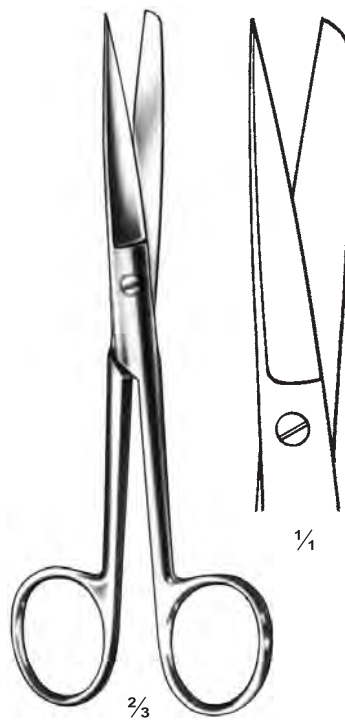

Sh/BI  
**56-10-10** 10 cm / 4"  
**56-11-11** 11.5 cm / 4½"  
**56-12-12** 12.5 cm / 5"  
**56-13-14** 14 cm / 5½"  
**56-14-14** 14.5 cm / 5¾"  
**56-15-15** 15 cm / 6"  
**56-16-17** 17 cm / 6¾"  
**56-17-18** 18 cm / 7"  
**56-18-20** 20 cm / 8"

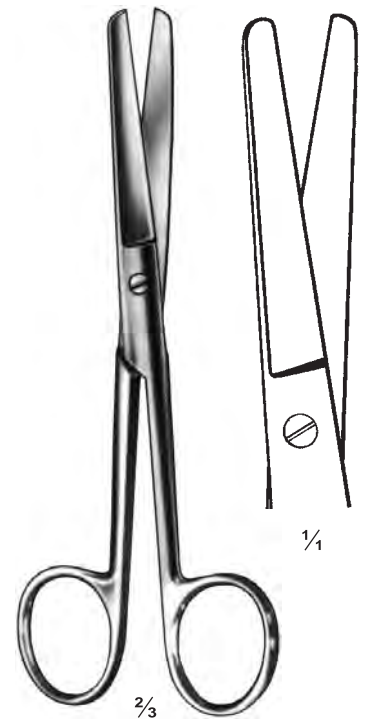

BI/BI  
**56-19-10** 10 cm / 4"  
**56-20-11** 11.5 cm / 4½"  
**56-21-12** 12.5 cm / 5"  
**56-22-14** 14 cm / 5½"  
**56-23-14** 14.5 cm / 5¾"  
**56-24-15** 15 cm / 6"  
**56-25-17** 17 cm / 6¾"  
**56-26-18** 18 cm / 7"  
**56-27-20** 20 cm / 8"

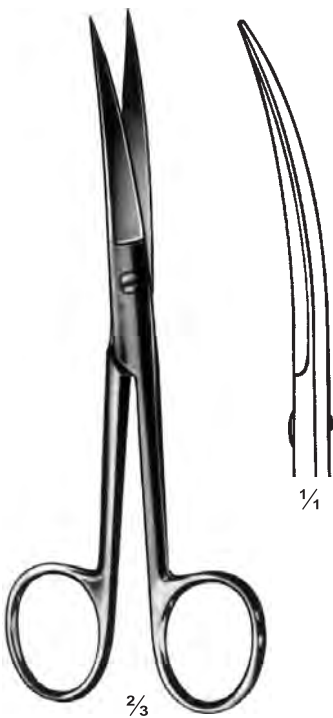

- Sh/Sh
- 57-01-10** 10 cm / 4"
  - 57-02-11** 11.5 cm / 4½"
  - 57-03-12** 12.5 cm / 5"
  - 57-04-14** 14 cm / 5½"
  - 57-05-14** 14.5 cm / 5¾"
  - 57-06-15** 15 cm / 6"
  - 57-07-17** 17 cm / 6¾"
  - 57-08-18** 18 cm / 7"
  - 57-09-20** 20 cm / 8"

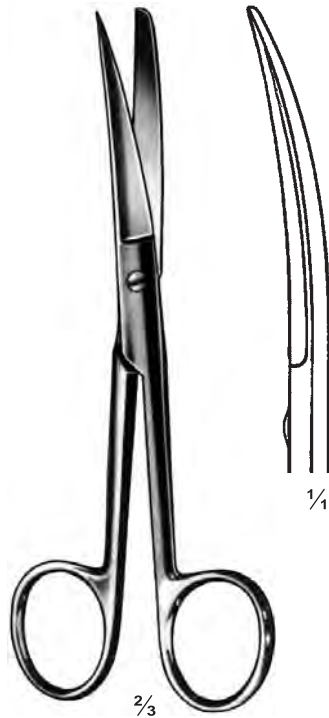

- Sh/BI
- 57-10-10** 10 cm / 4"
  - 57-11-11** 11.5 cm / 4½"
  - 57-12-12** 12.5 cm / 5"
  - 57-13-14** 14 cm / 5½"
  - 57-14-14** 14.5 cm / 5¾"
  - 57-15-15** 15 cm / 6"
  - 57-16-17** 17 cm / 6¾"
  - 57-17-18** 18 cm / 7"
  - 57-18-20** 20 cm / 8"

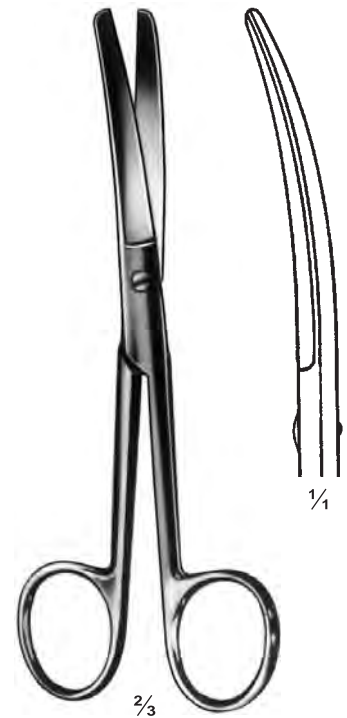

- BI/BI
- 57-19-10** 10 cm / 4"
  - 57-20-11** 11.5 cm / 4½"
  - 57-21-12** 12.5 cm / 5"
  - 57-22-14** 14 cm / 5½"
  - 57-23-14** 14.5 cm / 5¾"
  - 57-24-15** 15 cm / 6"
  - 57-25-17** 17 cm / 6¾"
  - 57-26-18** 18 cm / 7"
  - 57-27-20** 20 cm / 8"





Standard  
Sh/Sh  
58-01-10 10 cm / 4"  
58-02-11 11.5 cm / 4½"  
58-03-12 12.5 cm / 5"  
58-04-14 14 cm / 5½"  
58-05-14 14.5 cm / 5¾"  
58-06-15 15 cm / 6"  
58-07-17 17 cm / 6¾"  
58-08-18 18 cm / 7"  
58-09-20 20 cm / 8"



Standard  
Sh/Bl  
58-10-10 10 cm / 4"  
58-11-11 11.5 cm / 4½"  
58-12-12 12.5 cm / 5"  
58-13-14 14 cm / 5½"  
58-14-14 14.5 cm / 5¾"  
58-15-15 15 cm / 6"  
58-16-17 17 cm / 6¾"  
58-17-18 18 cm / 7"  
58-18-20 20 cm / 8"



Standard  
Bl/Bl  
58-19-10 10 cm / 4"  
58-20-11 11.5 cm / 4½"  
58-21-12 12.5 cm / 5"  
58-22-14 14 cm / 5½"  
58-23-14 14.5 cm / 5¾"  
58-24-15 15 cm / 6"  
58-25-17 17 cm / 6¾"  
58-26-18 18 cm / 7"  
58-27-20 20 cm / 8"



Standard  
Sh/Sh  
58-28-10 10 cm / 4"  
58-29-11 11.5 cm / 4½"  
58-30-12 12.5 cm / 5"  
58-31-14 14 cm / 5½"  
58-32-14 14.5 cm / 5¾"  
58-33-15 15 cm / 6"  
58-34-17 17 cm / 6¾"  
58-35-18 18 cm / 7"  
58-36-20 20 cm / 8"



Standard  
Sh/Bl  
58-37-10 10 cm / 4"  
58-38-11 11.5 cm / 4½"  
58-39-12 12.5 cm / 5"  
58-40-14 14 cm / 5½"  
58-41-14 14.5 cm / 5¾"  
58-42-15 15 cm / 6"  
58-43-17 17 cm / 6¾"  
58-44-18 18 cm / 7"  
58-45-20 20 cm / 8"



Standard  
Bl/Bl  
58-46-10 10 cm / 4"  
58-47-11 11.5 cm / 4½"  
58-48-12 12.5 cm / 5"  
58-49-14 14 cm / 5½"  
58-50-14 14.5 cm / 5¾"  
58-51-15 15 cm / 6"  
58-52-17 17 cm / 6¾"  
58-53-18 18 cm / 7"  
58-54-20 20 cm / 8"



59-01-13 13 cm / 5 $\frac{1}{8}$ "  
59-02-14 14.5 cm / 5 $\frac{3}{4}$ "



59-03-13 13 cm / 5 $\frac{1}{8}$ "  
59-04-14 14.5 cm / 5 $\frac{3}{4}$ "



59-05-13 13 cm / 5 $\frac{1}{8}$ "  
59-06-14 14.5 cm / 5 $\frac{3}{4}$ "



House-Toennis  
59-07-18  
18 cm / 7"

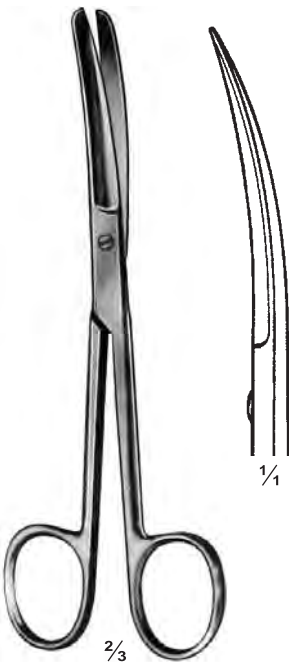

59-08-13 13 cm / 5 $\frac{1}{8}$ "  
59-09-14 14.5 cm / 5 $\frac{3}{4}$ "



59-10-13 13 cm / 5 $\frac{1}{8}$ "  
59-11-14 14.5 cm / 5 $\frac{3}{4}$ "



59-12-13 13 cm / 5 $\frac{1}{8}$ "  
59-13-14 14.5 cm / 5 $\frac{3}{4}$ "

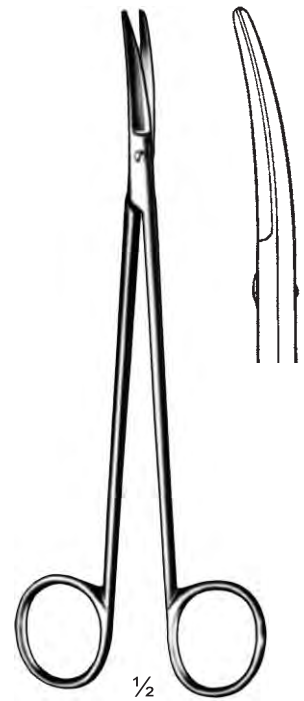

Toennis  
59-14-18  
18 cm / 7"

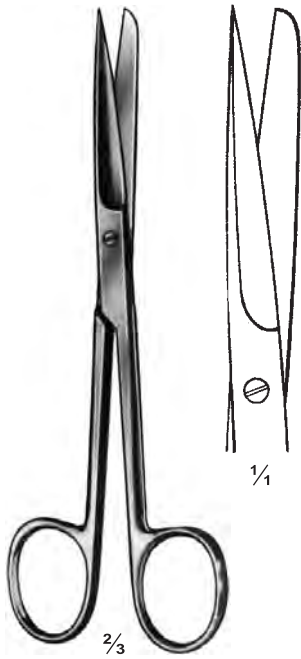

Deaver  
60-01-14  
14 cm / 5½"



Deaver  
60-02-14  
14 cm / 5½"



Deaver  
60-03-14  
14 cm / 5½"

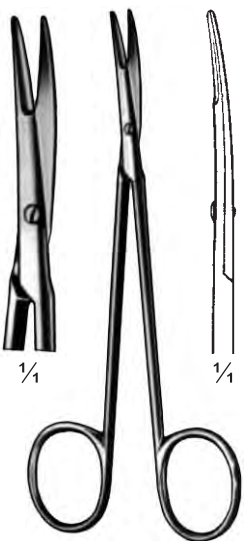

Shea  
60-04-12  
12 cm / 4¾"

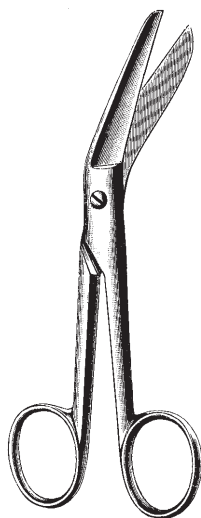

Richter  
60-05-13 13 cm / 5⅛"  
60-06-14 14.5 cm / 5¾"

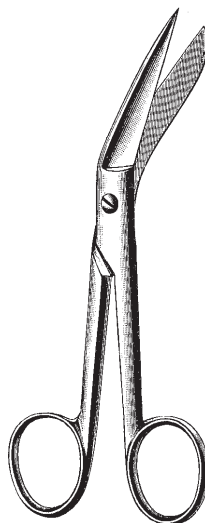

Richter  
60-07-13 13 cm / 5⅛"  
60-08-14 14.5 cm / 5¾"



Richter  
60-09-13 13 cm / 5⅛"  
60-10-14 14.5 cm / 5¾"

# Chirurgische Scheren Operating Scissors Ciseaux Chirurgicaux

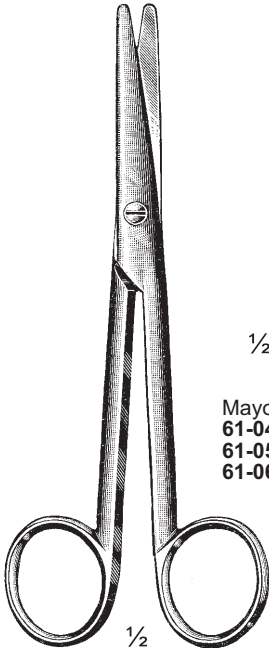

Mayo-Stille  
61-04-15 15 cm / 6"  
61-05-17 17 cm / 6<sup>3</sup>/<sub>4</sub>"  
61-06-18 18 cm / 7"



1/2

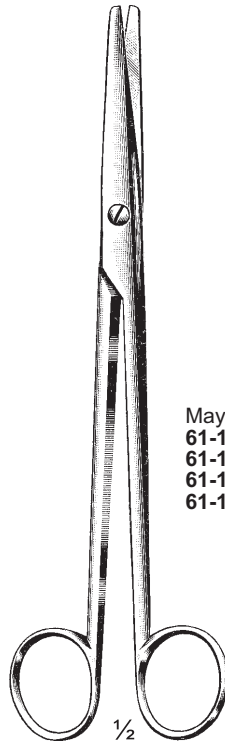

Mayo-Stille  
61-11-20 20 cm / 8"  
61-12-23 23 cm / 9"  
61-13-24 24 cm / 9<sup>1</sup>/<sub>2</sub>"  
61-14-25 25 cm / 10"

1/2

1/2

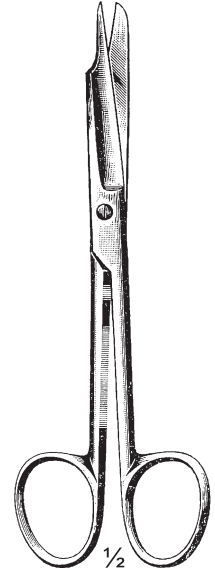

Sh/Probe  
61-15-14 14 cm / 5<sup>1</sup>/<sub>2</sub>"  
61-16-15 15 cm / 6"  
Sh/Probe

1/2

Mayo-Stille  
61-01-15 15 cm / 6"  
61-02-17 17 cm / 6<sup>3</sup>/<sub>4</sub>"  
61-03-18 18 cm / 7"

Mayo-Stille  
61-07-20 20 cm / 8"  
61-08-23 23 cm / 9"  
61-09-24 24 cm / 9<sup>1</sup>/<sub>2</sub>"  
61-10-25 25 cm / 10"

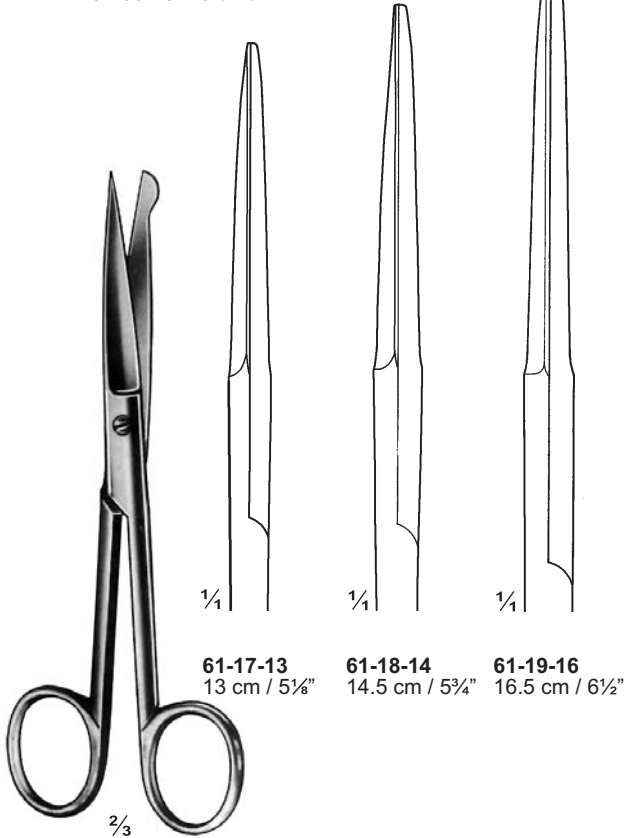

61-17-13  
13 cm / 5<sup>1</sup>/<sub>8</sub>"

61-18-14  
14.5 cm / 5<sup>3</sup>/<sub>4</sub>"

61-19-16  
16.5 cm / 6<sup>1</sup>/<sub>2</sub>"

1/4

1/4

1/4

2/3



Ferguson  
61-20-16  
16.5 cm / 6<sup>1</sup>/<sub>2</sub>"

1/4

2/3

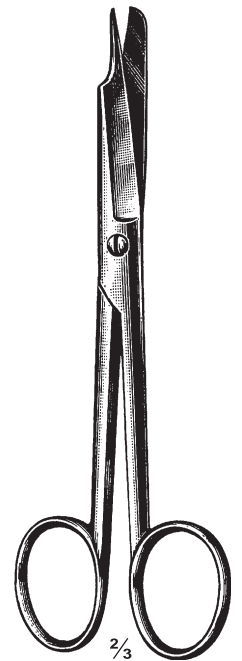

61-21-13 13 cm / 5<sup>1</sup>/<sub>8</sub>"  
61-22-15 15 cm / 6"

2/3

61-17-13 To 61-19-16  
Sh/Probe

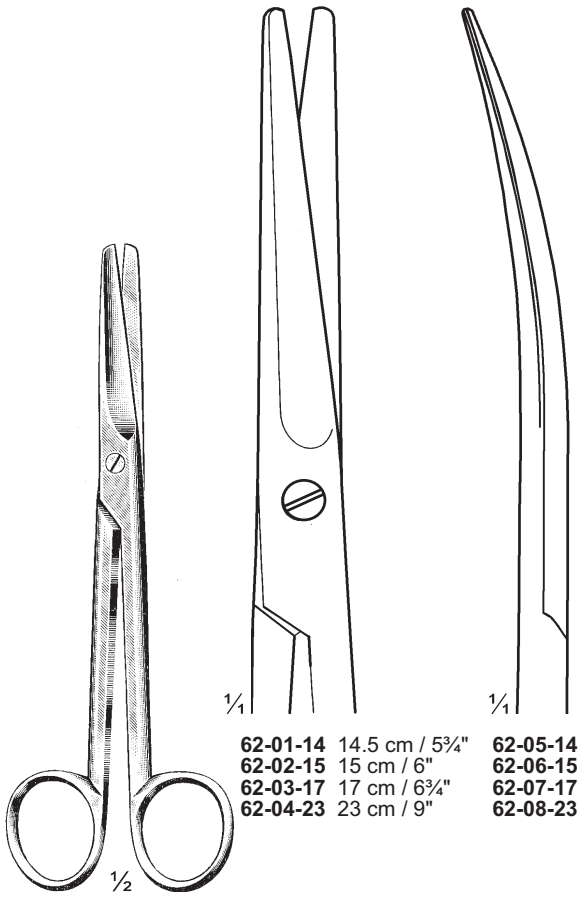

**62-01-14** 14.5 cm / 5<sup>3</sup>/<sub>4</sub>"    **62-05-14**  
**62-02-15** 15 cm / 6"            **62-06-15**  
**62-03-17** 17 cm / 6<sup>3</sup>/<sub>4</sub>"        **62-07-17**  
**62-04-23** 23 cm / 9"            **62-08-23**

Mayo  
62-01-14 To 62-08-23

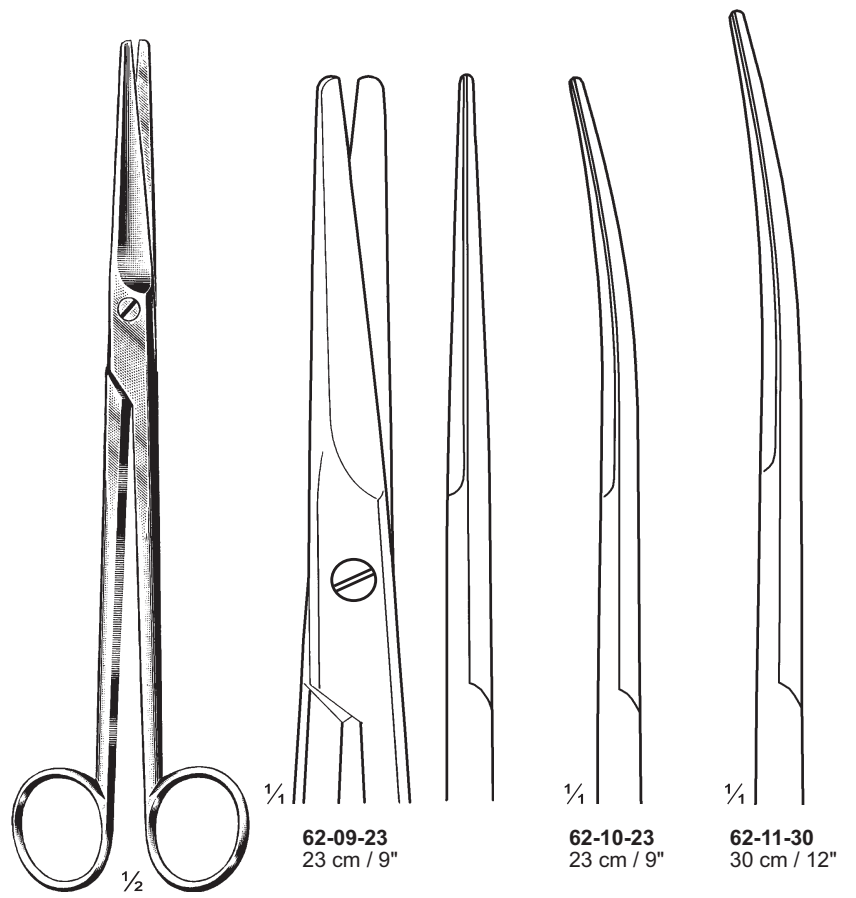

**62-09-23**  
23 cm / 9"

**62-10-23**  
23 cm / 9"

**62-11-30**  
30 cm / 12"

Mayo-Harrington  
62-09-23 To 62-11-30



Mayo-Harrington  
**62-12-20** 20 cm / 8"  
**62-13-23** 23 cm / 9"

Mayo-Harrington  
**62-14-20** 20 cm / 8"  
**62-15-23** 23 cm / 9"



Doyen  
**62-16-18**  
18 cm / 7"

Doyen  
**62-17-18**  
18 cm / 7"



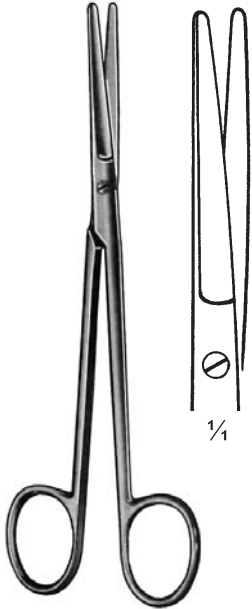

Werheim  
63-01-14  
14.5 cm / 5¾"

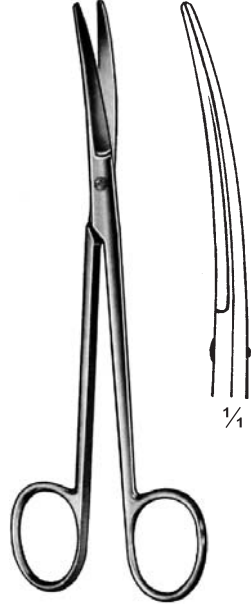

Werheim  
63-02-14  
14.5 cm / 5¾"



Werheim  
63-03-20 20 cm / 8"  
63-04-23 23 cm / 9"



Werheim  
63-05-20 20 cm / 8"  
63-06-23 23 cm / 9"

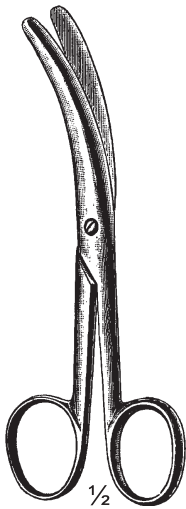

63-07-13  
13.5 cm / 5¼"

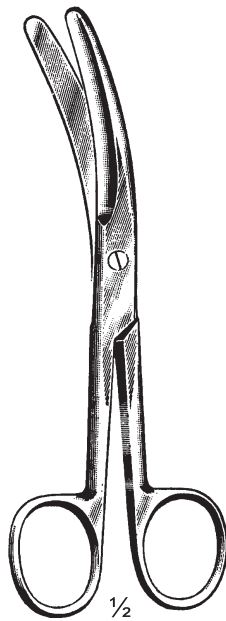

63-08-16  
16 cm / 6¼"

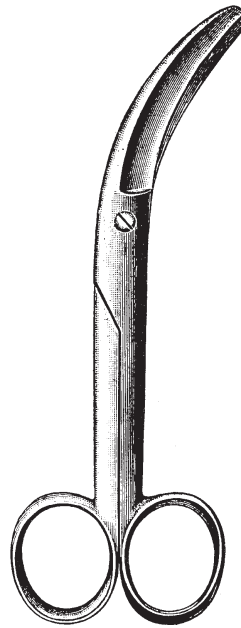

63-09-12 12.5 cm / 5"  
63-10-15 15 cm / 6"  
63-11-18 18 cm / 7"

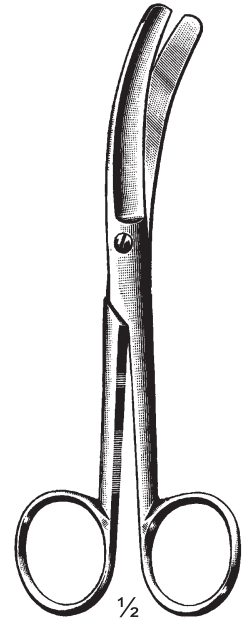

Busch  
63-12-16  
16 cm / 6¼"

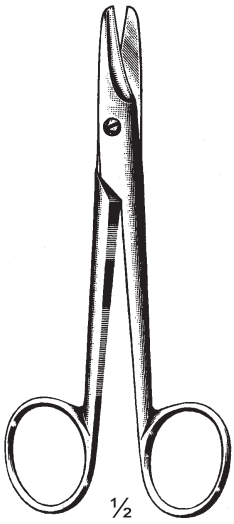

Systrunk  
64-01-13  
13 cm / 5 1/8"

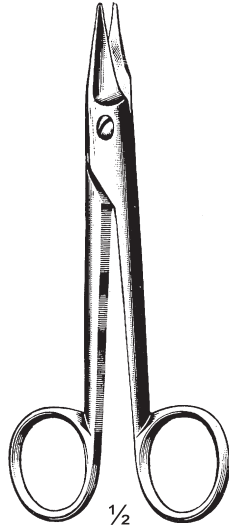

Systrunk  
64-02-13  
13 cm / 5 1/8"

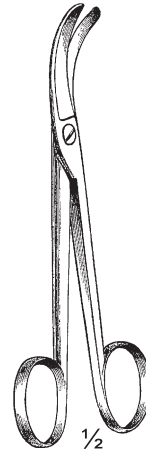

Dublin  
64-03-12  
12 cm / 4 3/4"

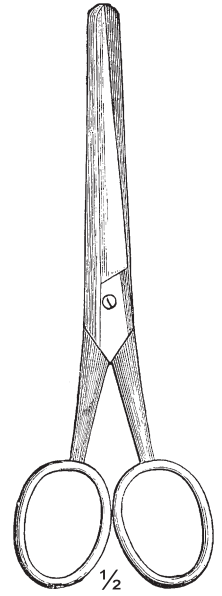

Ward  
64-04-12 12.5 cm / 5"  
64-05-15 15 cm / 6"  
64-06-18 18 cm / 7"

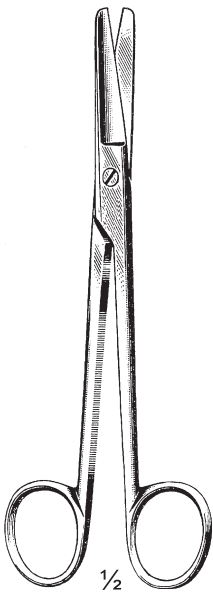

Mixer  
64-07-15  
15.5 cm / 6 1/8"

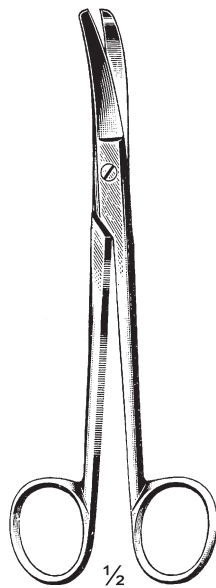

Mixer  
64-08-15  
15.5 cm / 6 1/8"

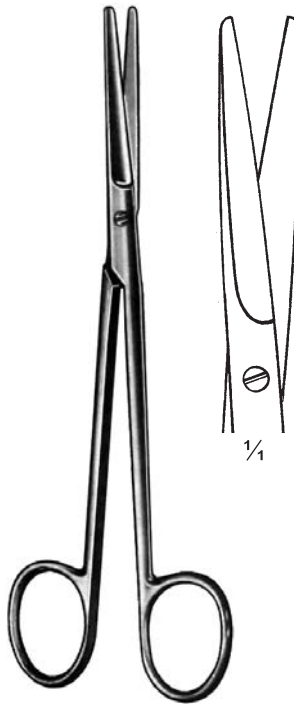

Mixer  
64-09-15  
15.5 cm / 6 1/8"

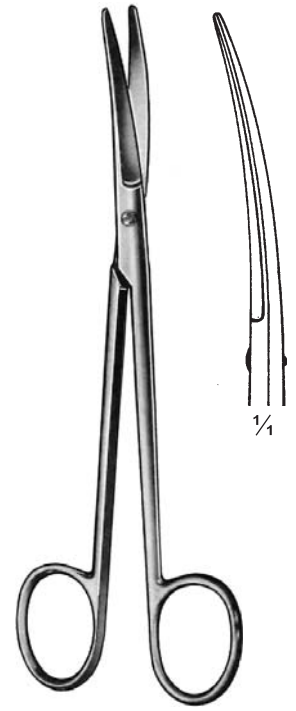

Mixer  
64-10-15  
15.5 cm / 6 1/8"

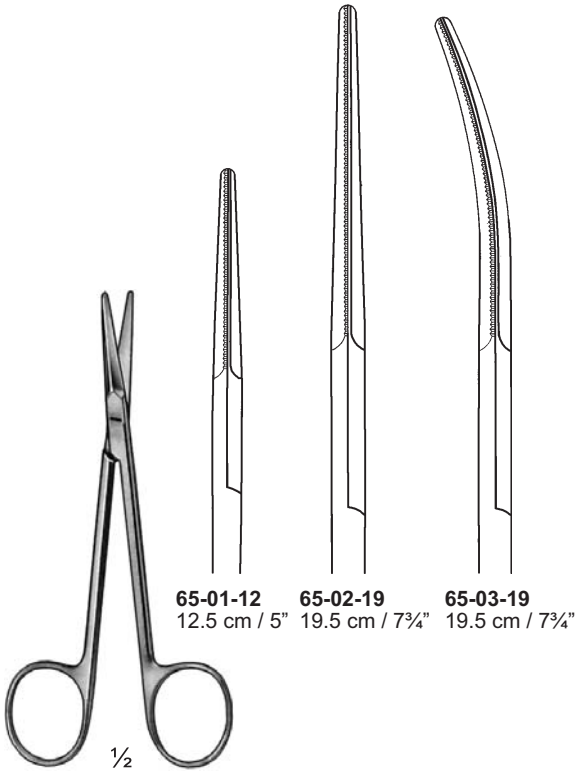

**65-01-12** 12.5 cm / 5"  
**65-02-19** 19.5 cm / 7¾"  
**65-03-19** 19.5 cm / 7¾"

**65-04-14** 14.5 cm / 5¾"  
**65-05-14** 14.5 cm / 5¾"  
**65-06-14** 14.5 cm / 5¾"  
**65-07-14** 14.5 cm / 5¾"

**Gorney**  
**65-01-12 To 65-03-19**  
Both blades serrated

**Metzenbaum-Fino**  
**65-04-14 & 65-05-14**  
14.5 cm / 5¾"

**Metzenbaum**  
**65-06-14 & 65-07-14**  
14.5 cm / 5¾"

**Metzenbaum-Fino**  
**65-08-14**  
14.5 cm / 5¾"

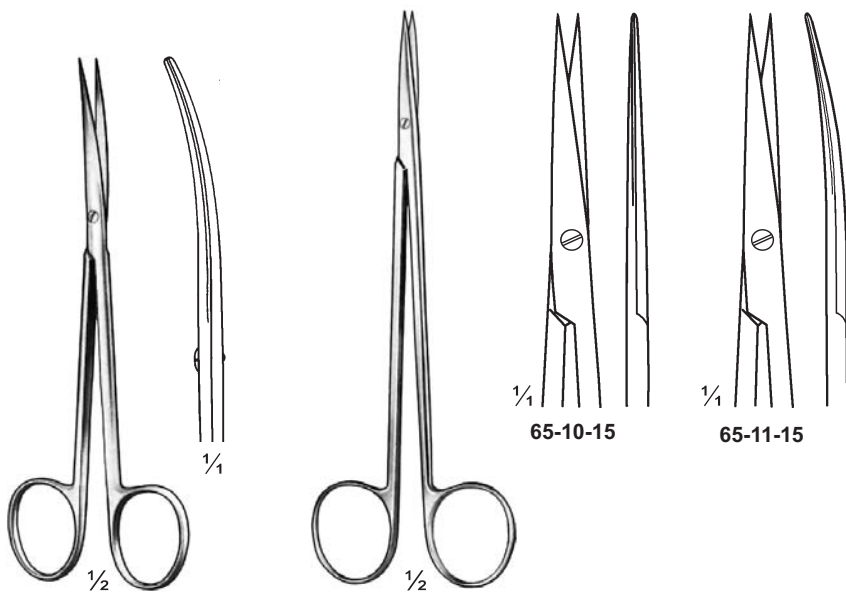

**65-10-15** 15 cm / 6"  
**65-11-15** 15 cm / 6"

**Metzenbaum-Fino**  
**65-09-14**  
14.5 cm / 5¾"

**Nerve-Preparation**  
**65-10-15 & 65-11-15**  
15 cm / 6"

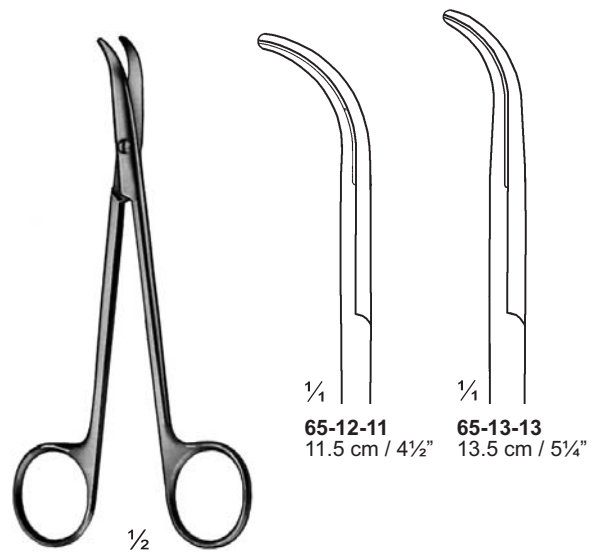

**65-12-11** 11.5 cm / 4½"  
**65-13-13** 13.5 cm / 5¼"

**Fomon**  
**65-12-11 & 65-13-13**

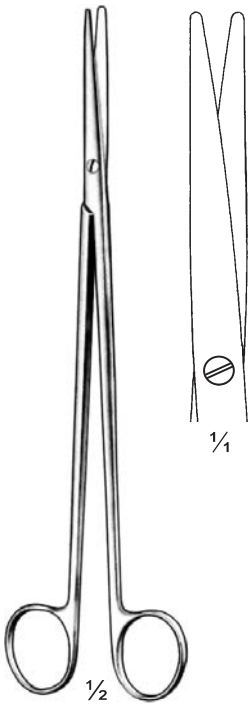

Metzenbaum-Fino  
66-01-18 18 cm / 7"  
66-02-20 20 cm / 8"  
66-03-23 23 cm / 9"

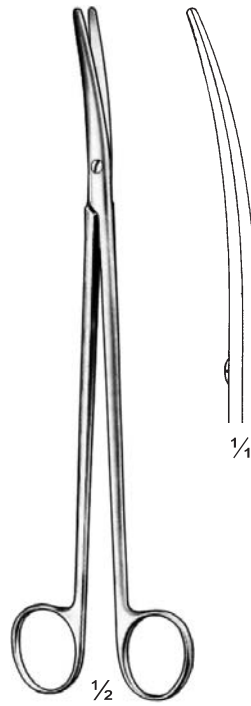

Metzenbaum-Fino  
66-04-18 18 cm / 7"  
66-05-20 20 cm / 8"  
66-06-23 23 cm / 9"

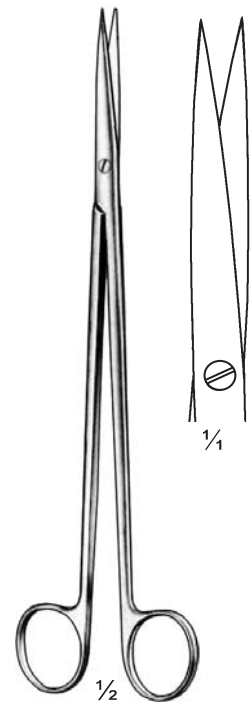

Metzenbaum-Fino  
66-07-18 18 cm / 7"  
66-08-20 20 cm / 8"  
66-09-23 23 cm / 9"

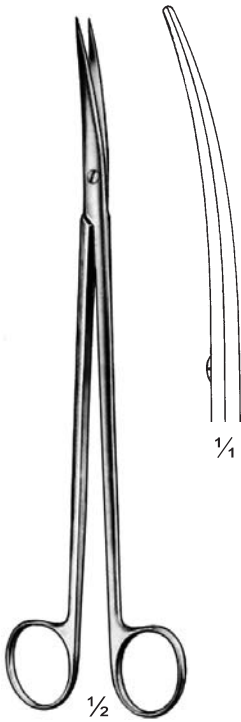

Metzenbaum-Fino  
66-10-18 18 cm / 7"  
66-11-20 20 cm / 8"  
66-12-23 23 cm / 9"

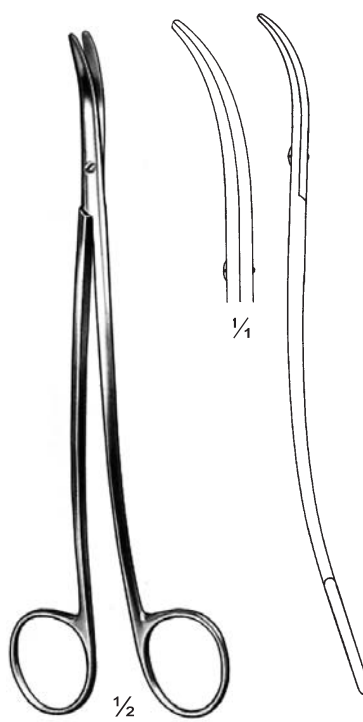

Metzenbaum-Fino  
66-13-18 18 cm / 7"  
66-14-20 20 cm / 8"  
66-15-23 23 cm / 9"

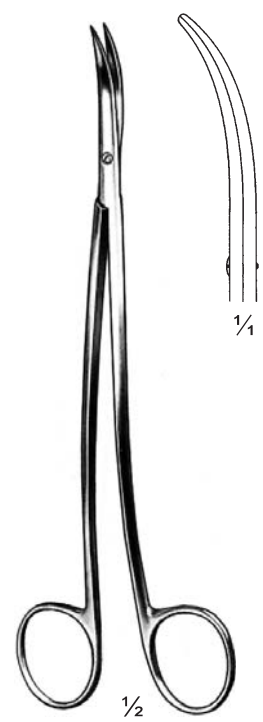

Metzenbaum-Fino  
66-16-18 18 cm / 7"  
66-17-20 20 cm / 8"  
66-18-23 23 cm / 9"

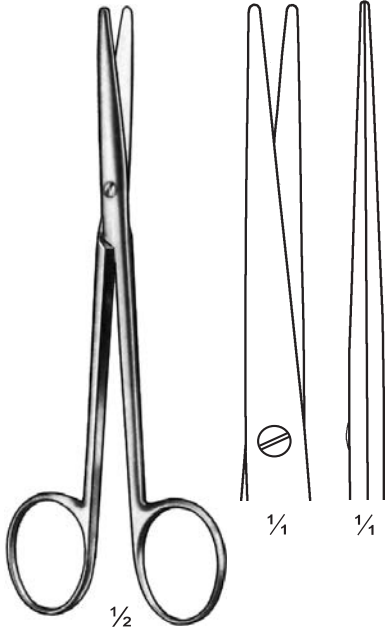

**Lexer-Fino**  
**67-01-16** 16 cm / 6¼"  
**67-02-21** 21 cm / 8¼"

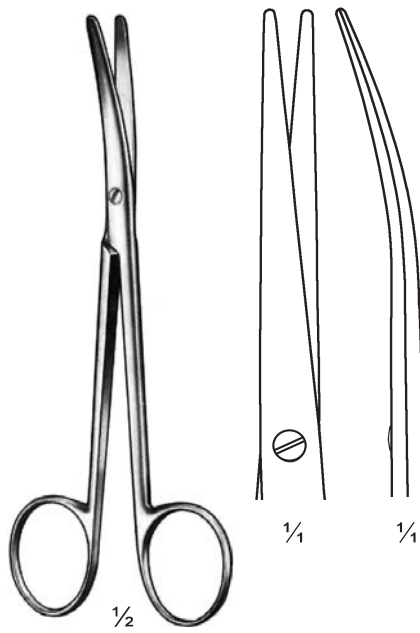

**Lexer-Fino**  
**67-03-16** 16 cm / 6¼"  
**67-04-21** 21 cm / 8¼"

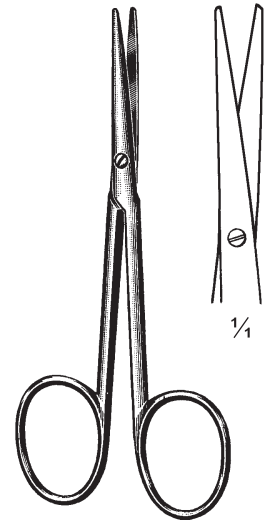

**Lexer-Baby (Knapp)**  
**67-05-10**  
 10 cm / 4"

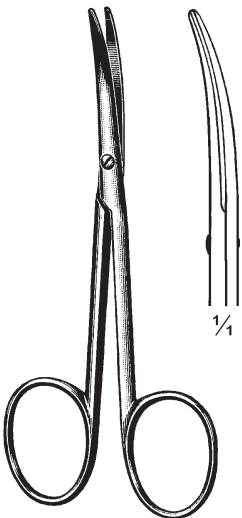

**Lexer-Baby (Knapp)**  
**67-06-10**  
 10 cm / 4"

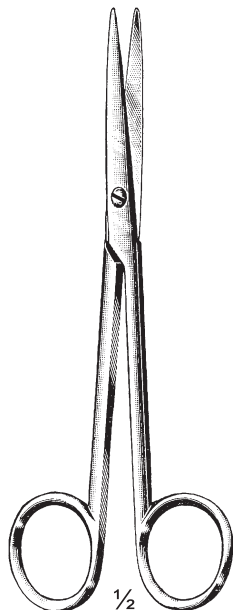

**Lexer-Fino**  
**67-08-16** 16 cm / 6¼"  
**67-09-21** 21 cm / 8¼"

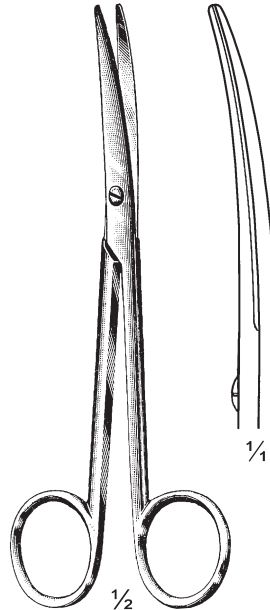

**Lexer-Fino**  
**67-09-16** 16 cm / 6¼"  
**67-10-21** 21 cm / 8¼"

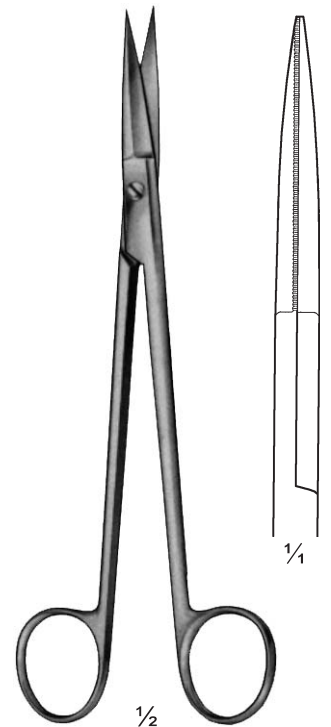

**67-11-18**  
 18.5 cm / 7¼"  
 Both blades  
 serrated



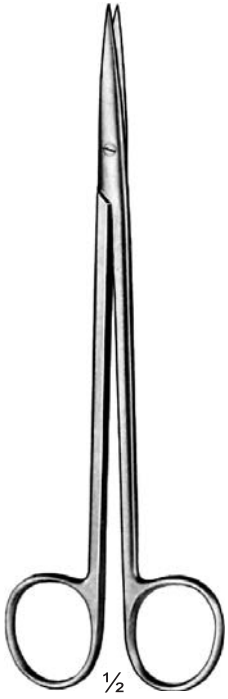

Metzenbaum-Nelson  
68-01-18 To 68-06-30



1/4  
68-01-18  
18 cm / 7"



1/4  
68-02-20  
20 cm / 8"



1/4  
68-03-23  
23 cm / 9"



1/4  
68-04-25  
25 cm / 10"



1/4  
68-05-28  
28 cm / 11"



1/4  
68-06-30  
30 cm / 12"

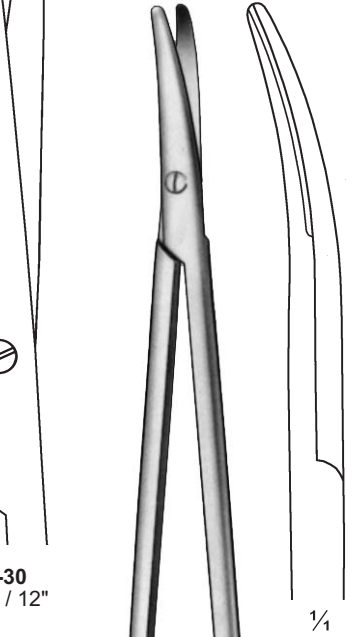

1/2  
Weller  
68-13  
28 cm / 11"  
Heavy pattern



Metzenbaum-Nelson  
68-07-18 To 68-12-30  
Sh/Sh



1/4  
68-07-18  
18 cm / 7"



1/4  
68-08-20  
20 cm / 8"



1/4  
68-09-23  
23 cm / 9"



1/4  
68-10-25  
25 cm / 10"



1/4  
68-11-28  
28 cm / 11"



1/4  
68-12-30  
30 cm / 12"



Metzenbaum-Nelson  
69-01-18 To 69-06-30



69-01-18  
18 cm / 7"



69-02-20  
20 cm / 8"



69-03-23  
23 cm / 9"

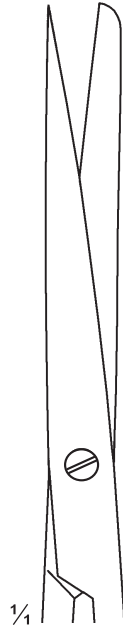

69-04-25  
25 cm / 10"

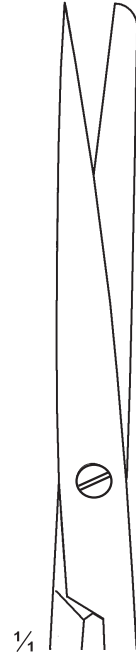

69-05-28  
28 cm / 11"

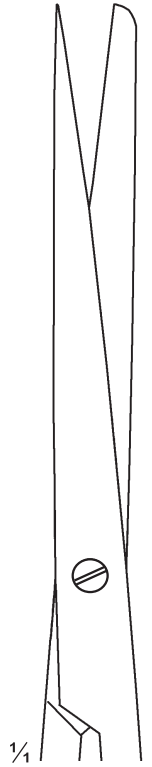

69-06-30  
30 cm / 12"

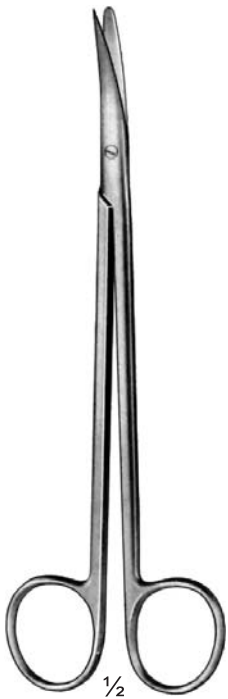

Metzenbaum-Nelson  
69-07-18 To 69-12-30  
Sh/Bl



69-07-18  
18 cm / 7"



69-08-20  
20 cm / 8"



69-09-23  
23 cm / 9"



69-10-25  
25 cm / 10"



69-11-28  
28 cm / 11"



69-12-30  
30 cm / 12"

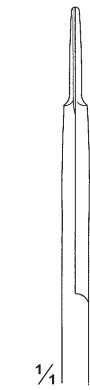

Ragnell  
69-13-13  
13.5 cm / 5 1/4"



Ragnell  
69-14-13  
13.5 cm / 5 1/4"

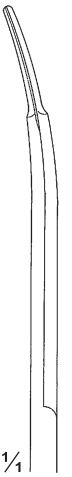

69-15-15  
15 cm / 6"

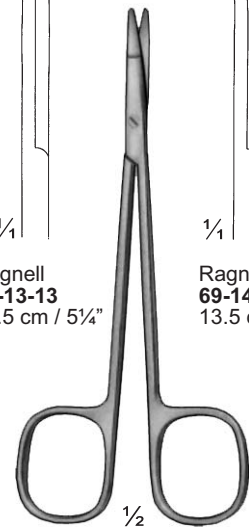

69-13-13 To 69-15-15



**Metzenbaum-Nelson**  
**70-01-18 To 70-06-30**

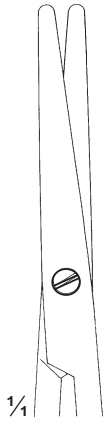

**70-01-18**  
 18 cm / 7"



**70-02-20**  
 20 cm / 8"



**70-03-23**  
 23 cm / 9"



**70-04-25**  
 25 cm / 10"



**70-05-28**  
 28 cm / 11"



**70-06-30**  
 30 cm / 12"



**Metzenbaum-Nelson**  
**70-07-18 To 70-12-30**  
 BI/BI



**70-07-18**  
 18 cm / 7"



**70-08-20**  
 20 cm / 8"



**70-09-23**  
 23 cm / 9"



**70-10-25**  
 25 cm / 10"



**70-11-28**  
 28 cm / 11"

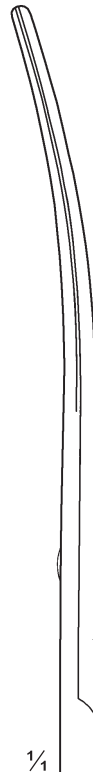

**70-12-30**  
 30 cm / 12"

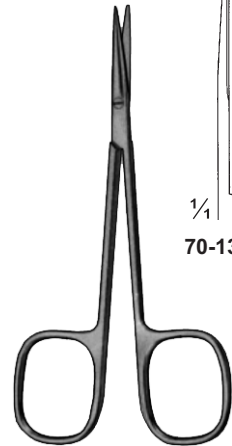

**70-13-11 & 70-14-11**  
 11.5 cm / 4½"



**70-13-11**



**70-14-11**

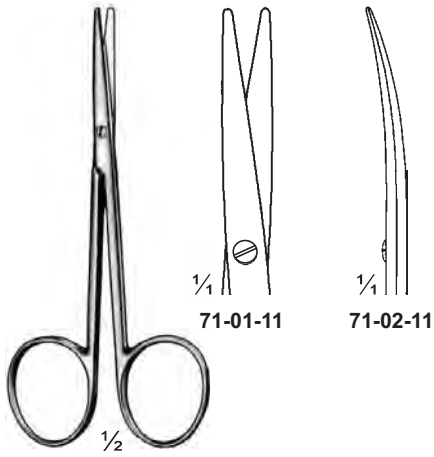

Metzenbaum  
71-01-11 & 71-02-11  
11.5 cm / 4½"

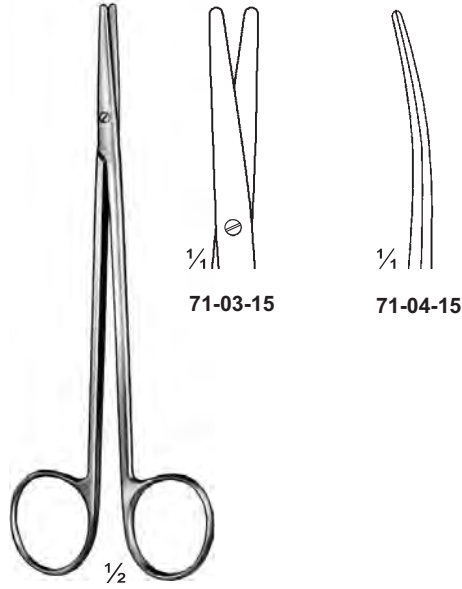

Metzenbaum  
71-03-15 & 71-04-15  
15 cm / 6"

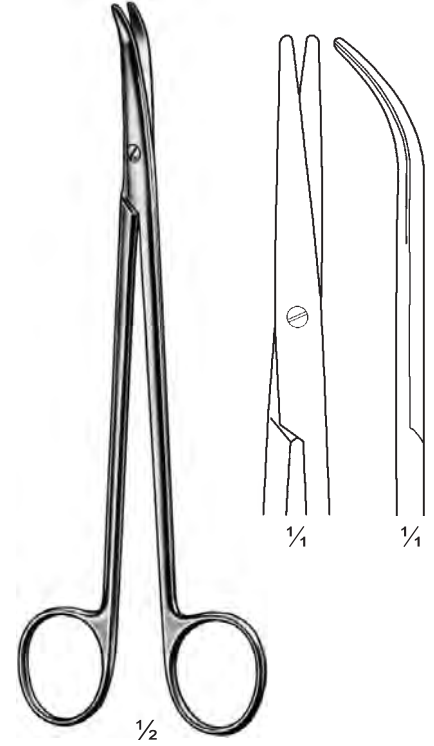

Thorek  
71-05-19  
19 cm / 7½"



Metzenbaum  
71-06-14 To 71-11-14  
14.5 cm / 5¾"



71-06-14  
Sh/Sh



71-07-14  
Sh/BI



71-08-14  
BI/BI



71-09-14  
Sh/Sh



71-10-14  
Sh/BI



71-11-14  
BI/BI

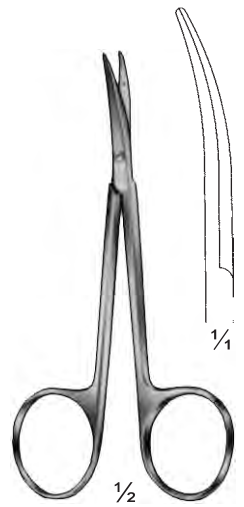

Littler  
71-12-11  
11.5 cm / 4½"  
Tip with eye for suture

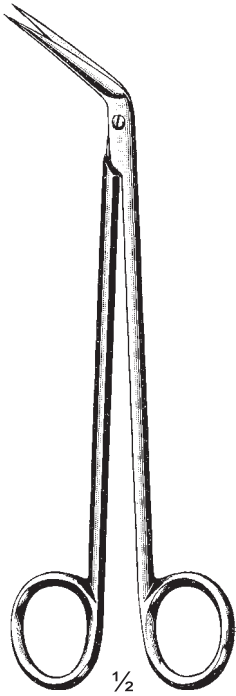

Potts-Smith  
**72-01-60 To 72-03-25**  
 19 cm / 7½"

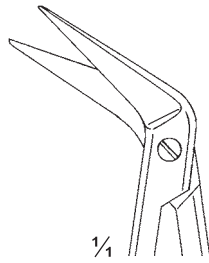

¼  
**72-01-60**  
 60°

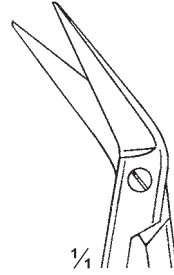

¼  
**72-02-45**  
 45°



¼  
**72-03-25**  
 25°

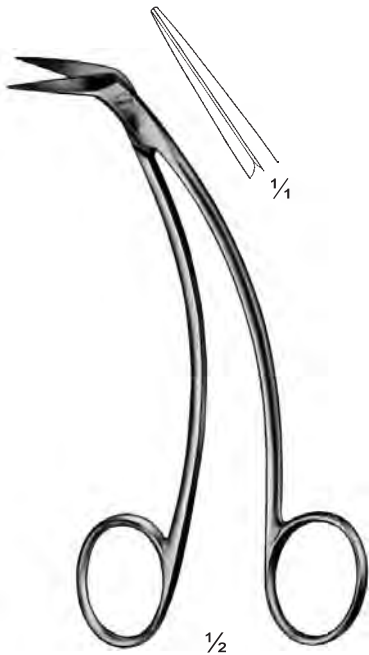

Favoloro  
**72-04-15** 15 cm / 6"  
**72-05-17** 17 cm / 6¾"

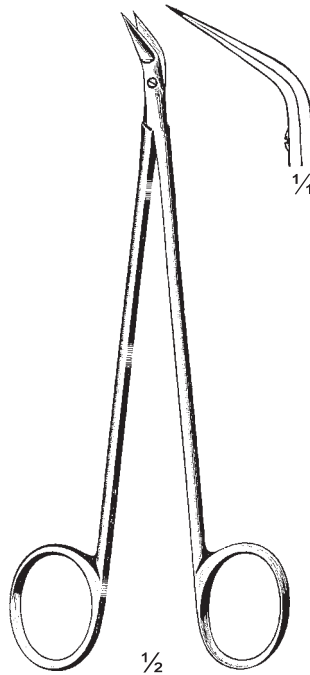

Potts-Smith  
**72-06-18** 18 cm / 7"  
**72-07-19** 19 cm / 7½"

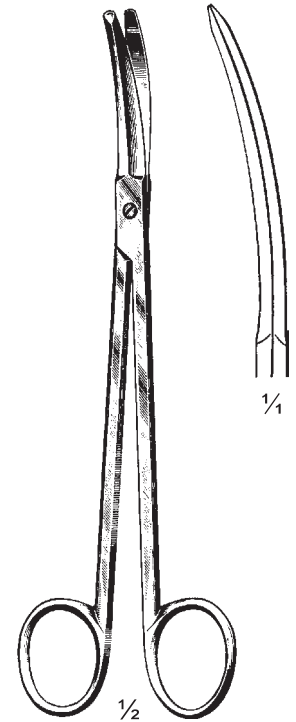

Potts-Smith  
**72-08-19**  
 19 cm / 7½"



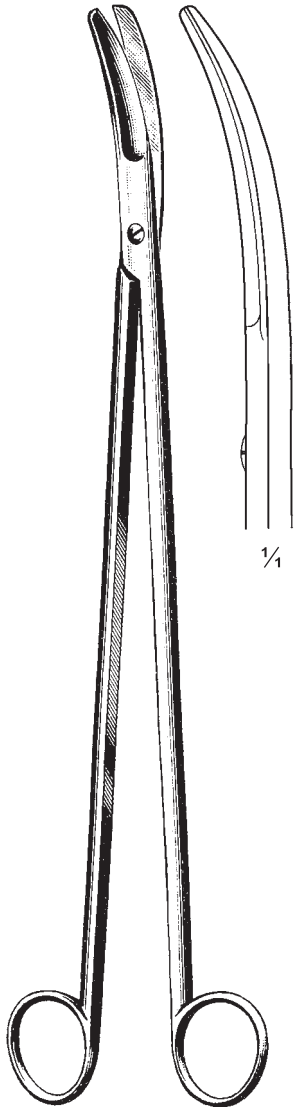

**Crafoord**  
**73-01-30**  
 30 cm / 12"

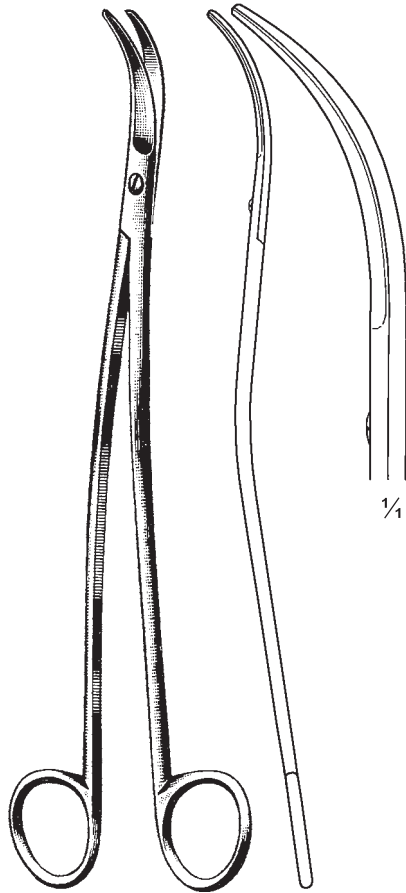

**Satinsky**  
**73-02-25**  
 25 cm / 10"

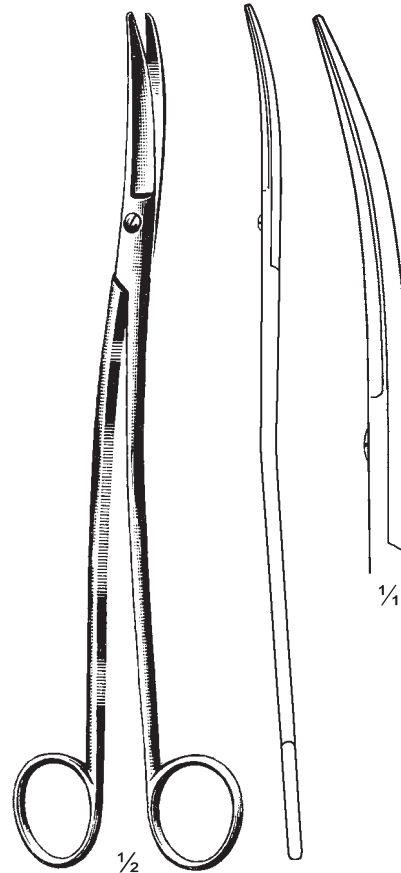

**Klinkenbergh-Loth**  
**73-03-23**  
 23 cm / 9"

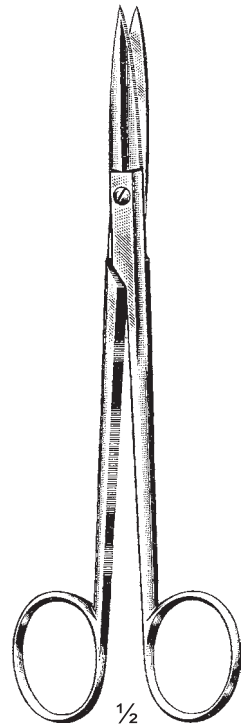

**McIndoe**  
**73-04-19**  
 19 cm / 7½"  
 One blade serrated

**Gefäßscheren  
Vascular Scissor  
Ciseaux Vasculaires**



Dietrich  
74-01-25 To 74-05-125

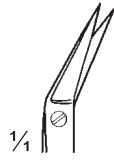

**74-01-25**  
18 cm / 7"  
25°

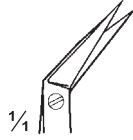

**74-02-45**  
18 cm / 7"  
45°

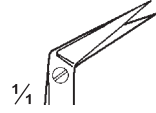

**74-03-60**  
18 cm / 7"  
60°



**74-04-90**  
17 cm / 6¾"  
90°



**74-05-125**  
17 cm / 6¾"  
125°

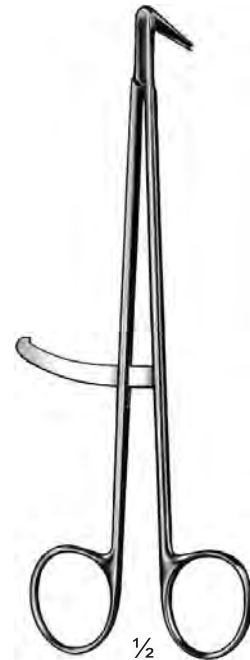

Dietrich  
**74-06-17**  
17 cm / 6¾"

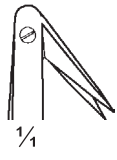

1/1

1/2

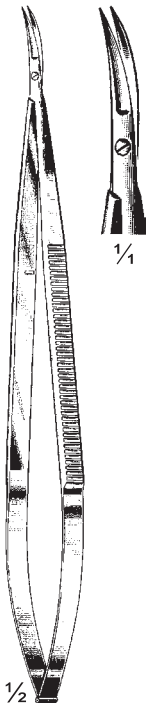

Jacobson  
**74-07-18**  
18.5 cm / 7¼"



1/1

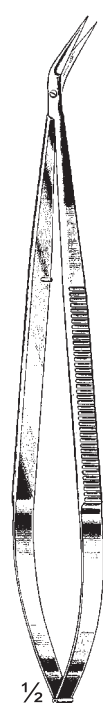

Yasargil  
**74-08-18**  
18.5 cm / 7¼"



1/1  
40°

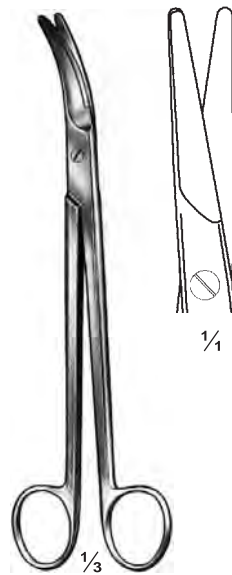

**74-09-22 & 74-10-23**



1/1

1/3



1/1

**74-09-22**  
22.5 cm / 8¾"



1/1

**74-10-23**  
23 cm / 9"

**Gefäßscheren  
Vascular Scissor  
Ciseaux Vasculaires**

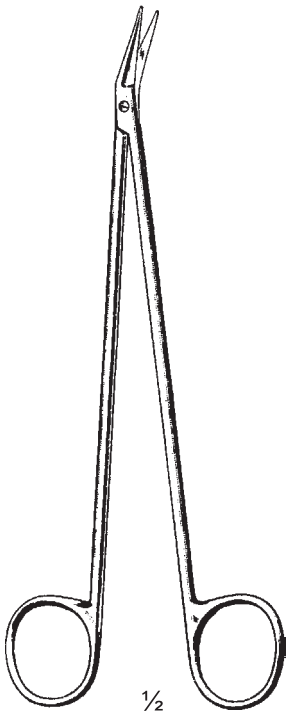

75-01-25 To 75-04-40

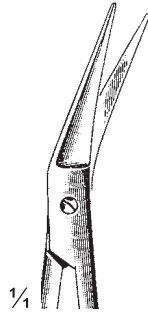

1/1  
Potts-De Martel  
75-01-25  
19 cm / 7½"  
25°

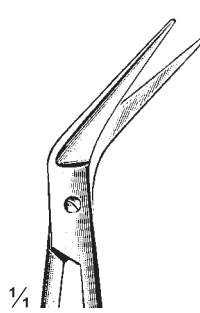

1/1  
Potts-De Martel  
75-02-40  
19 cm / 7½"  
40°

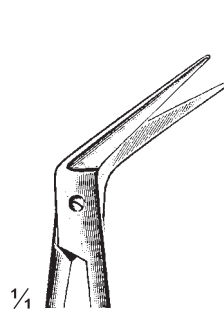

1/1  
Potts-De Martel  
75-03-60  
19 cm / 7½"  
60°

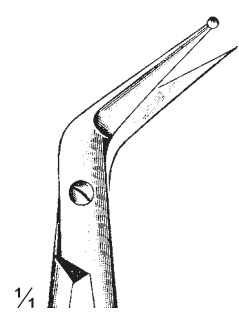

1/1  
Mills  
75-04-40  
21 cm / 8¼"  
40°  
Sh/Probe



Potts-De Martel  
75-05-21 & 75-06-24

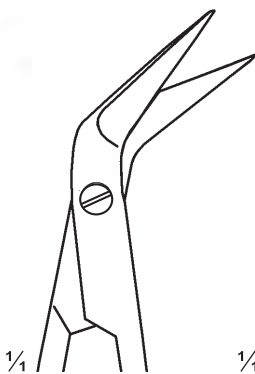

1/1  
75-05-21  
21 cm / 8¼"



1/1  
75-06-24  
24 cm / 9½"

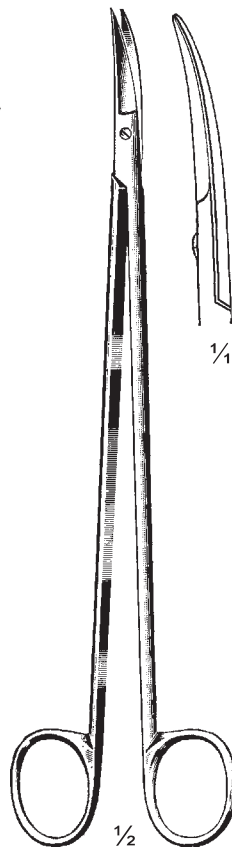

Strully  
75-07-22  
22 cm / 8¾"



1/1

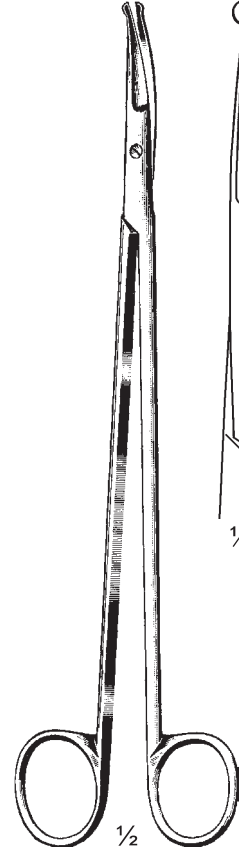

Strully  
75-08-22  
22 cm / 8¾"

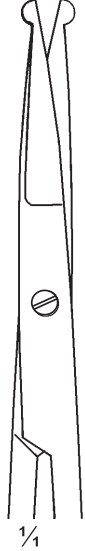

1/1

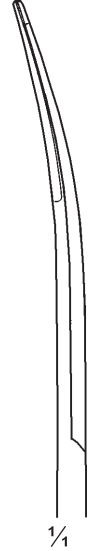

1/1

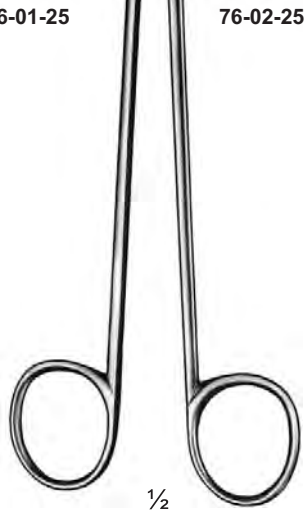

Duffield  
76-01-25 & 76-02-25  
25 cm / 10"

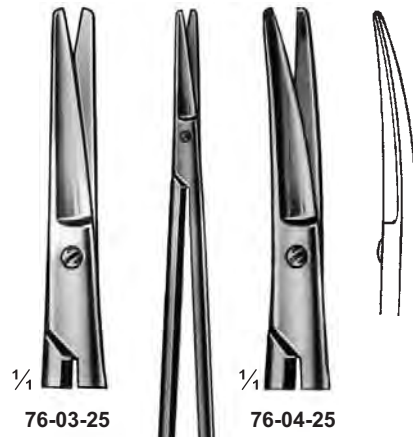

Church  
76-03-25 & 76-04-25  
25 cm / 10"



Lincoln  
76-05-25 & 76-06-25  
25 cm / 10"

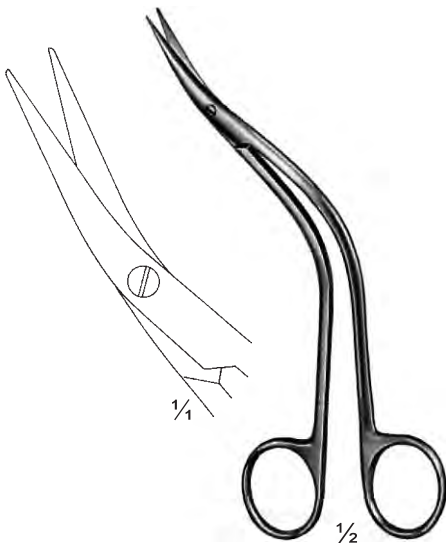

De Bakley  
77-01-15  
15.5 cm / 6 1/8"

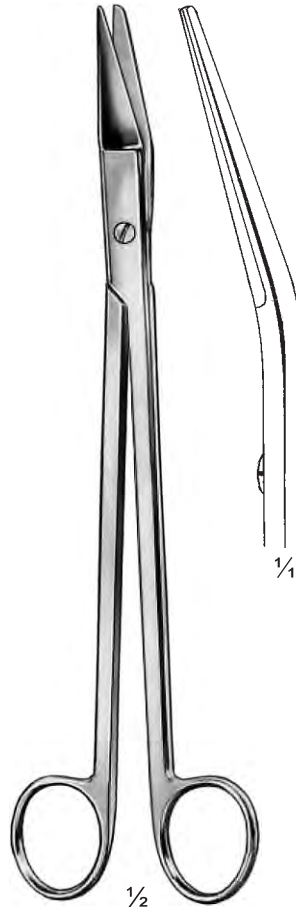

Resano  
77-02-23 23 cm / 9"  
77-03-25 25 cm / 10"

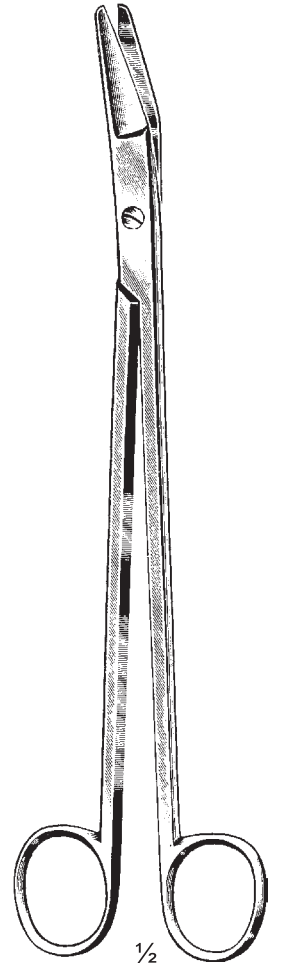

Resano  
77-04-23 23 cm / 9"  
77-05-25 25 cm / 10"

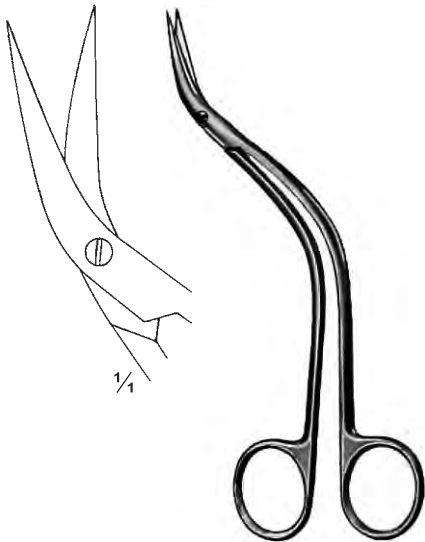

De Bakley  
77-06-15  
15.5 cm / 6 1/8"

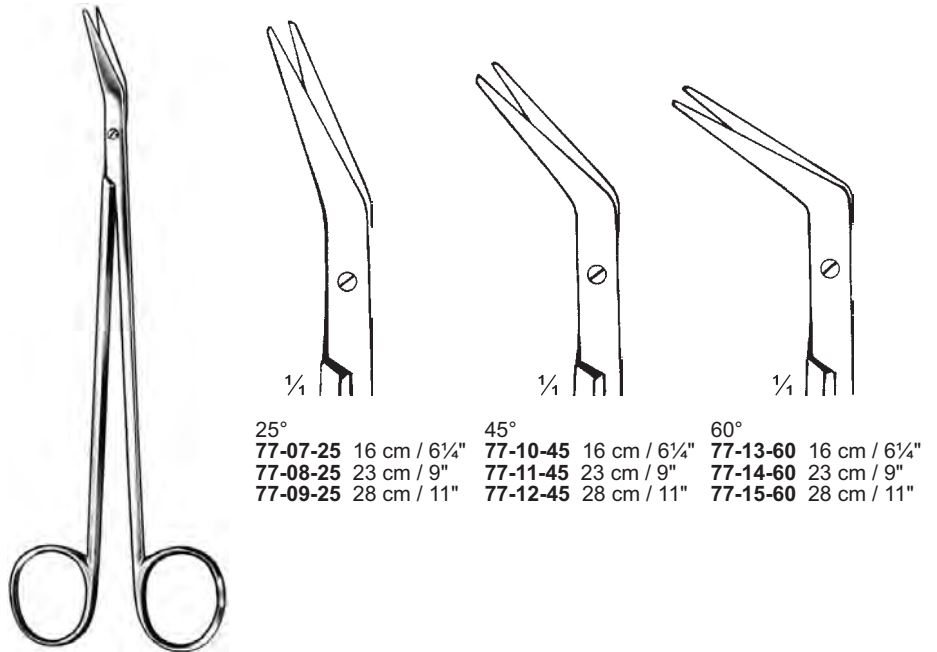

25°	45°	60°
77-07-25 16 cm / 6 1/4"	77-10-45 16 cm / 6 1/4"	77-13-60 16 cm / 6 1/4"
77-08-25 23 cm / 9"	77-11-45 23 cm / 9"	77-14-60 23 cm / 9"
77-09-25 28 cm / 11"	77-12-45 28 cm / 11"	77-15-60 28 cm / 11"

De Bakley  
77-07-25 To 77-15-60



**Gefäßscheren  
Vascular Scissor  
Ciseaux Vasculaires**

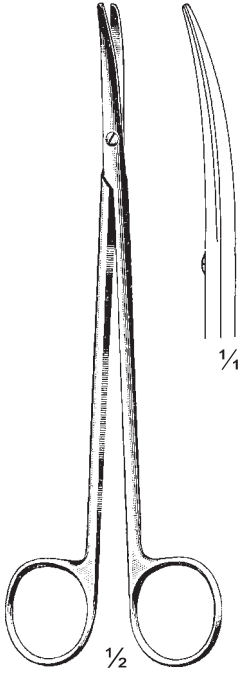

**Toennis-Adson**  
**78-01-18**  
18 cm / 7"

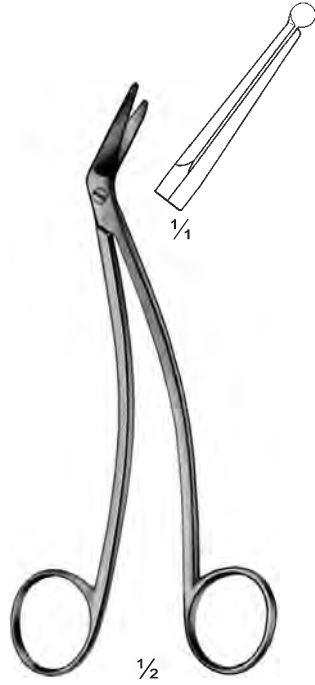

**Schmieden-Taylor**  
**78-02-16** 16 cm / 6¼"  
**78-03-17** 17 cm / 6¾"

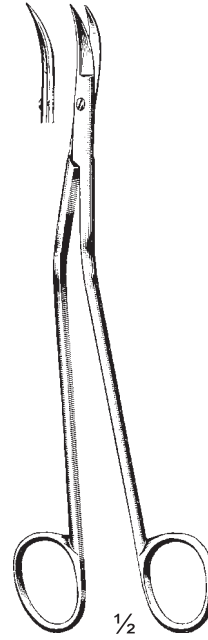

**Dandy**  
**78-04-17**  
17 cm / 6¾"

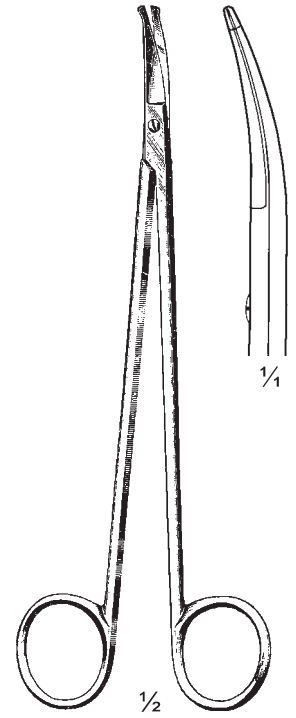

**Strully**  
**78-05-19** 19 cm / 7½"  
**78-06-22** 22 cm / 8¾"

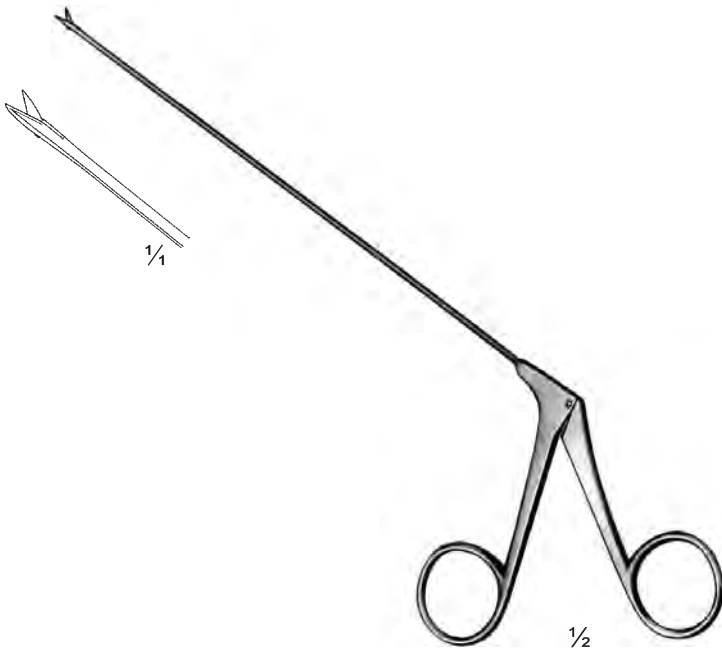

**78-07-23**  
23 cm / 9"

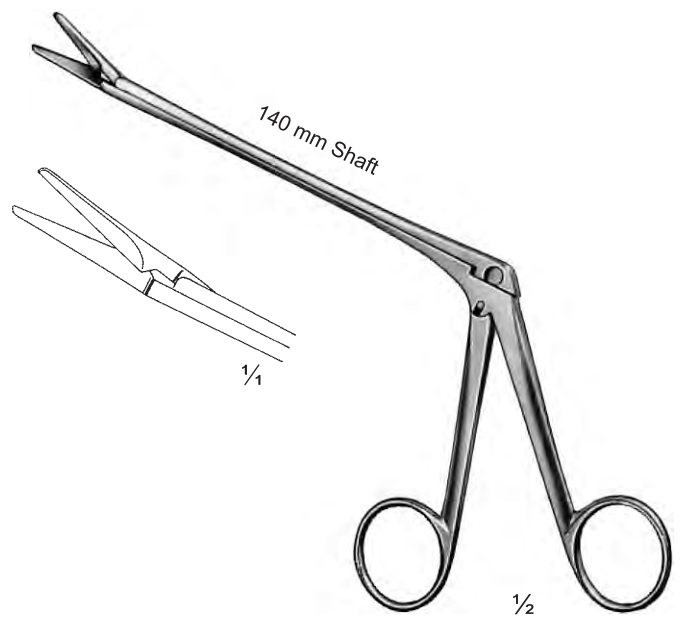

**Olivecrona**  
**78-08-23**  
23 cm / 9"

**Tonsillenscheren, Nasenscheren**  
**Tonsil & Nasal Scissors**  
**Ciseaux Pour les amygdales, Ciseaux nasaux**

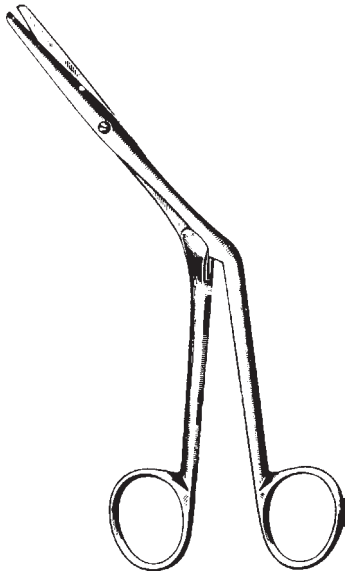

**Knight**  
**79-01-18**  
 18 cm / 7"

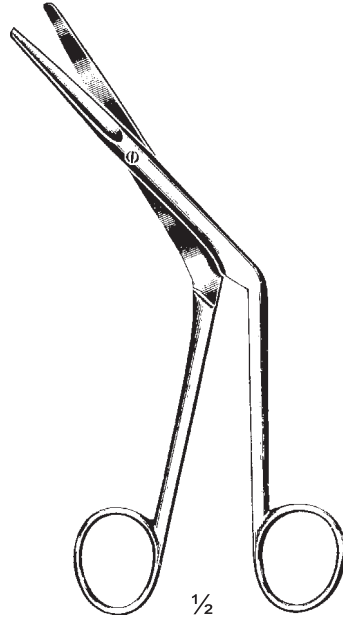

**Douglas**  
**79-02-18**  
 18 cm / 7"

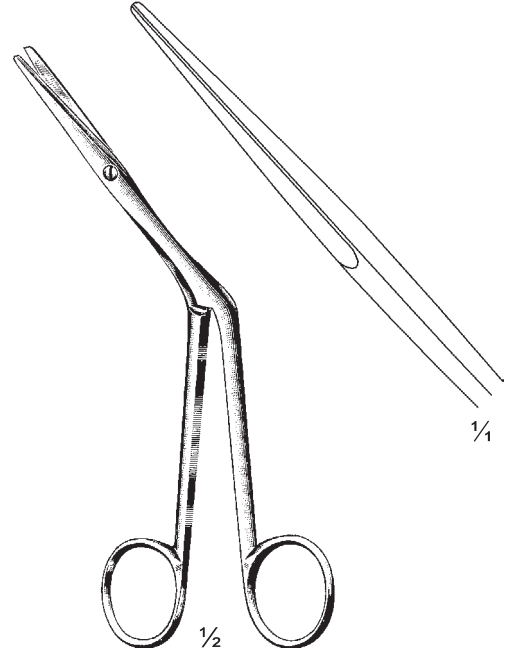

**Heymann**  
**79-03-18**  
 18 cm / 7"

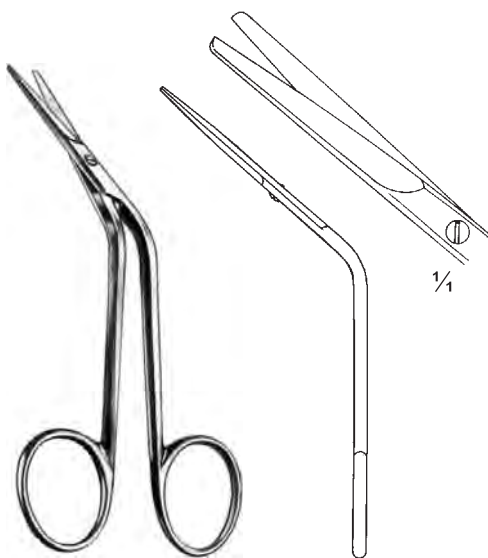

**Fomon**  
**79-04-15**  
 15 cm / 6"



**Cottle**  
**79-05-16**  
 16 cm / 6¼"

## Tonsillenscheren, Nasenscheren Tonsil & Nasal Scissors Ciseaux Pour les amygdales, Ciseaux nasaux

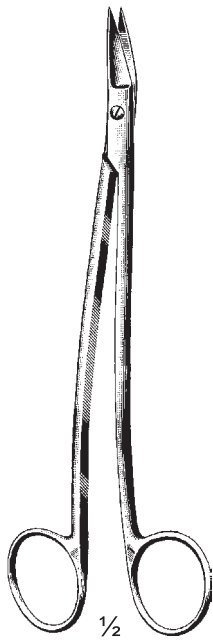

Dean  
80-01-17 & 80-02-17  
17 cm / 6<sup>3</sup>/<sub>4</sub>"

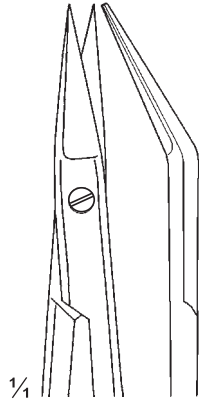

80-01-17

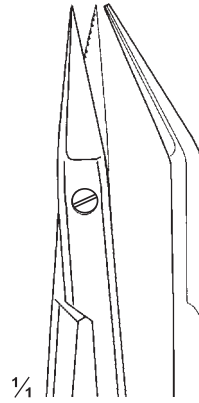

80-02-17  
One blade  
serrated

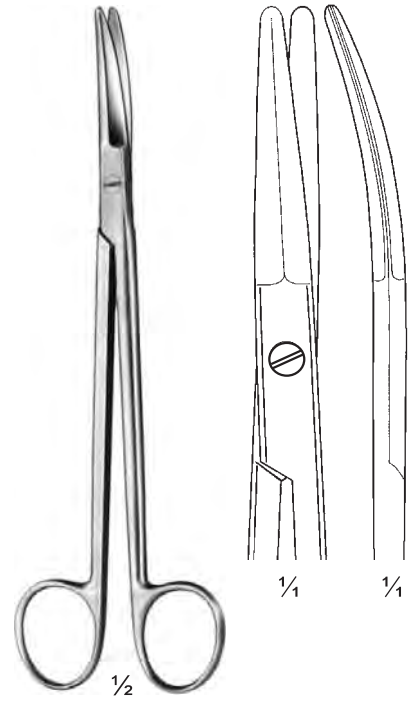

Boettcher  
80-03-18  
18 cm / 7"

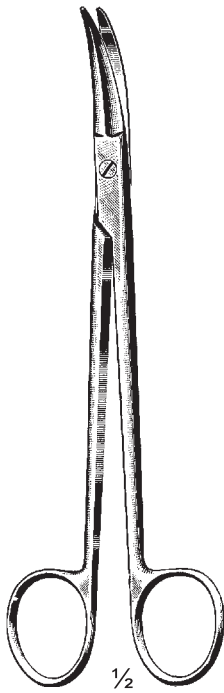

Prince  
80-04-18  
18 cm / 7"

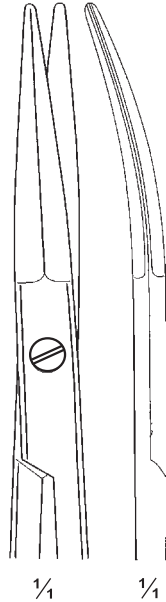

1/4

1/4



Good  
80-05-19  
19 cm / 7<sup>1</sup>/<sub>2</sub>"

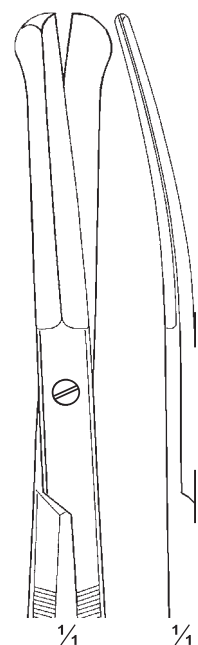

1/4

1/4

**Gynäkologische Scheren, Episiotomiesscheren**  
**Gynecological Scissors, Episiotomy Scissors**  
**Ciseaux à gynécologie, Ciseaux nasaux, Ciseaux à épisiotomie**

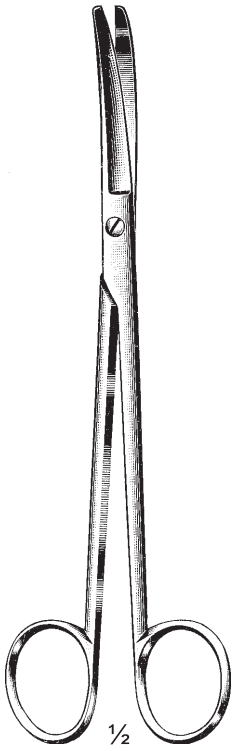

Werthiem  
81-01-14 To 81-03-23

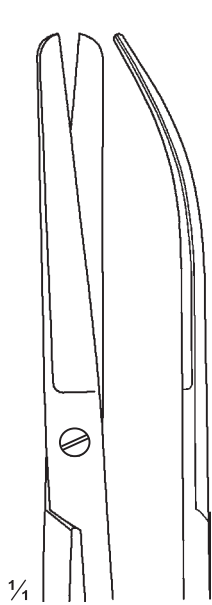

**81-01-14**  
14.5 cm / 5<sup>3</sup>/<sub>4</sub>"

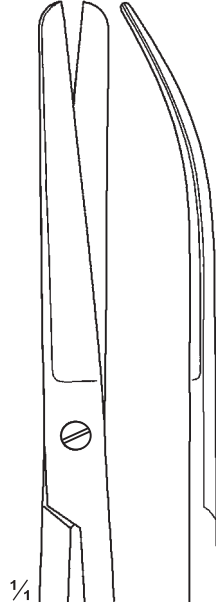

**81-02-19**  
19.5 cm / 7<sup>3</sup>/<sub>4</sub>"



**81-03-23**  
23 cm / 9"

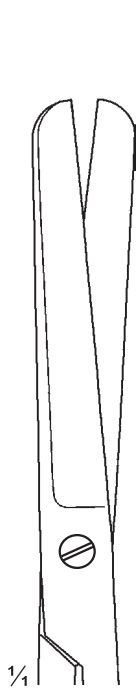

**81-04-20**  
20 cm / 8"

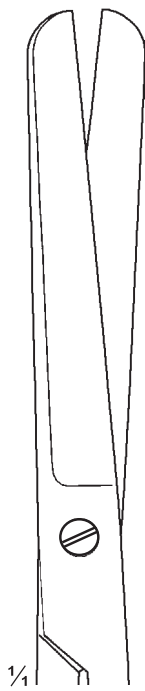

**81-05-23**  
23 cm / 9"



**81-06-20**  
20 cm / 8"



**81-07-23**  
23 cm / 9"

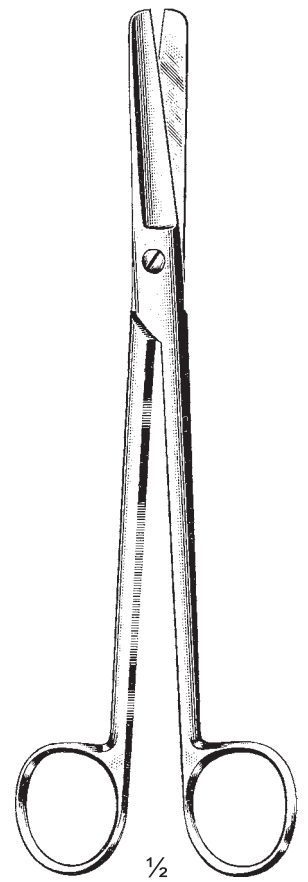

Sims  
81-04-20 To 81-07-23

**Gynäkologische Scheren, Episiotomiesscheren**  
**Gynecological Scissors, Episiotomy Scissors**  
**Ciseaux à gynécologie, Ciseaux nasaux, Ciseaux à épisiotomie**



Doyen  
**82-01-18 To 82-02-18**  
 18 cm / 7"



$\frac{1}{1}$   
**82-01-18**

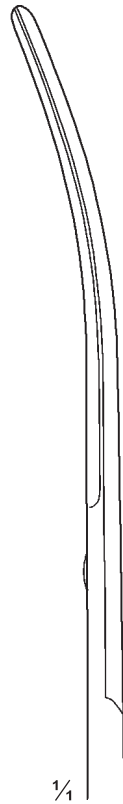

$\frac{1}{1}$   
**82-02-18**

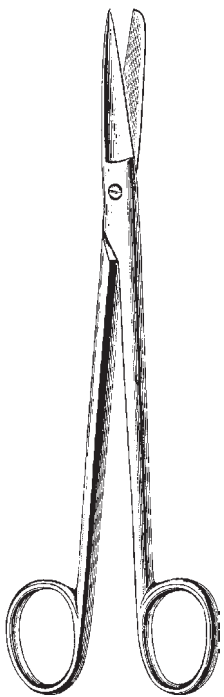

Sims  
**82-03-20 To 82-10-23**



**82-03-20**  
 20 cm / 8"  
**82-04-23**  
 23 cm / 9"



**82-05-20**  
 20 cm / 8"  
**82-06-23**  
 23 cm / 9"



**82-07-20**  
 20 cm / 8"  
**82-08-23**  
 23 cm / 9"



**82-09-20**  
 20 cm / 8"  
**82-10-23**  
 23 cm / 9"

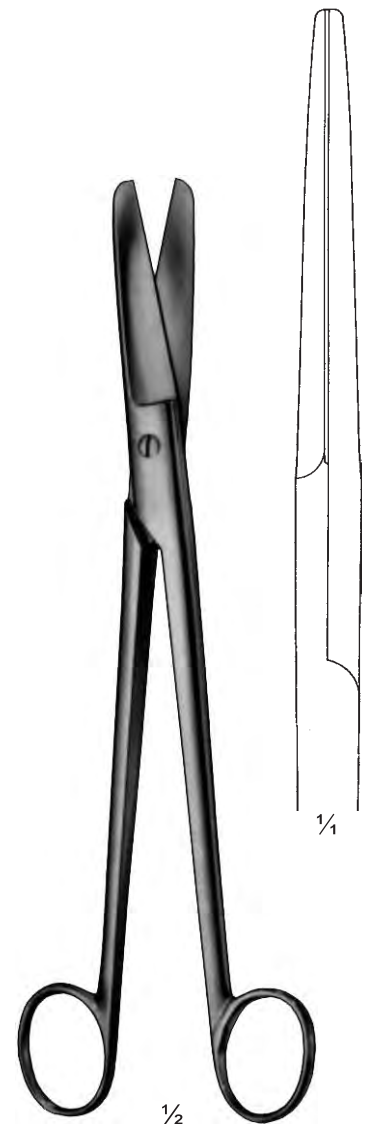

Sims-Siebold  
**82-11-25**  
 25 cm / 10"

$\frac{1}{4}$



**Gynäkologische Scheren, Episiotomiesscheren**  
**Gynecological Scissors, Episiotomy Scissors**  
**Ciseaux à gynécologie, Ciseaux nasaux, Ciseaux à épisiotomie**



1/2  
83-03-22

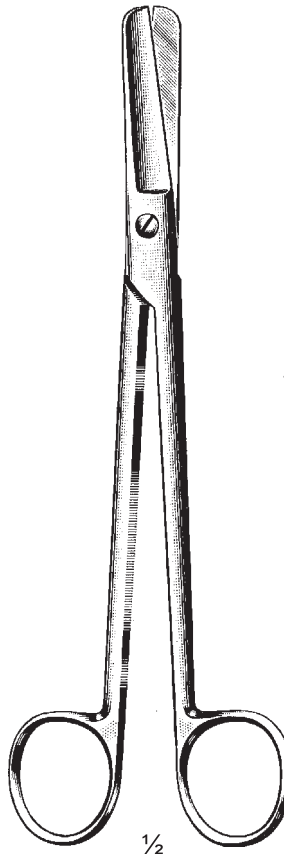

1/2

Sims  
83-03-22 To 83-04-22  
22 cm / 8 3/4"



1/2  
83-04-22



1/4

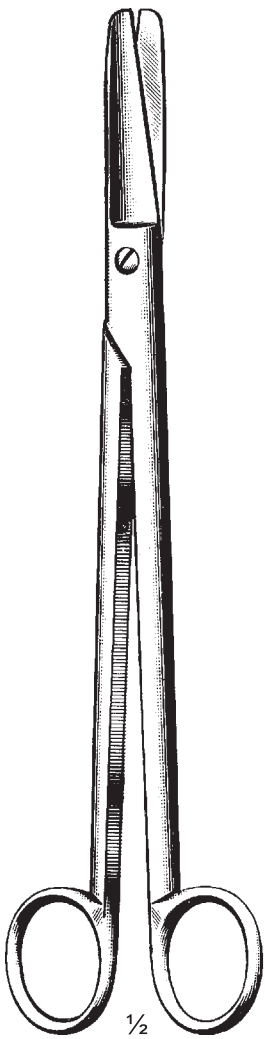

1/2

Dubois  
83-01-27  
27 cm / 10 1/2"

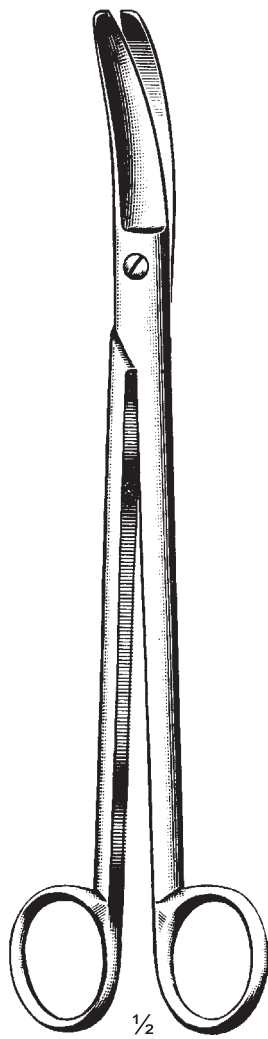

1/2

Dubois  
83-02-27  
27 cm / 10 1/2"

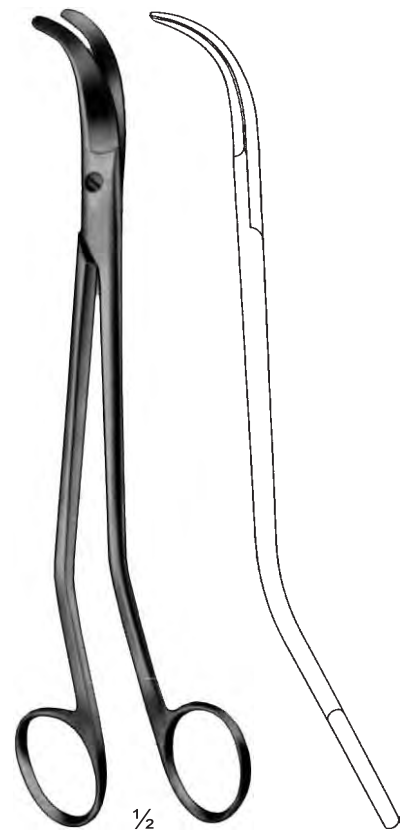

1/2

Bozemann  
83-05  
22 cm / 8 3/4"

**Gynäkologische Scheren, Episiotomiesscheren**  
**Gynecological Scissors, Episiotomy Scissors**  
**Ciseaux à gynécologie, Ciseaux nasaux, Ciseaux à épisiotomie**

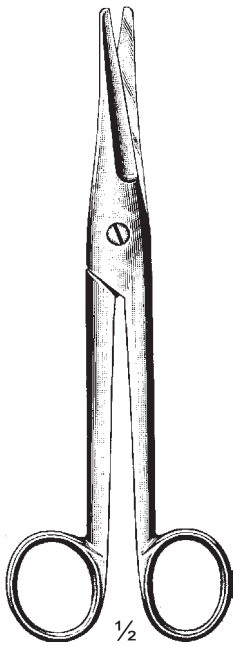

Mayo-Noble  
 84-01-14 To 84-04-17

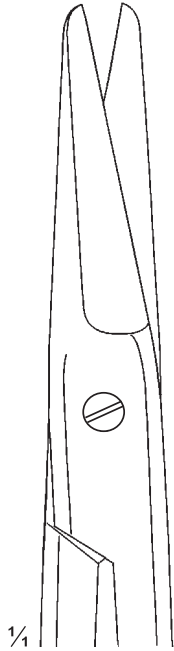

84-01-14 14 cm / 5½"  
 84-02-17 17 cm / 6¾"

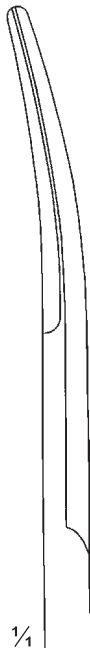

84-03-14 14 cm / 5½"  
 84-04-17 17 cm / 6¾"

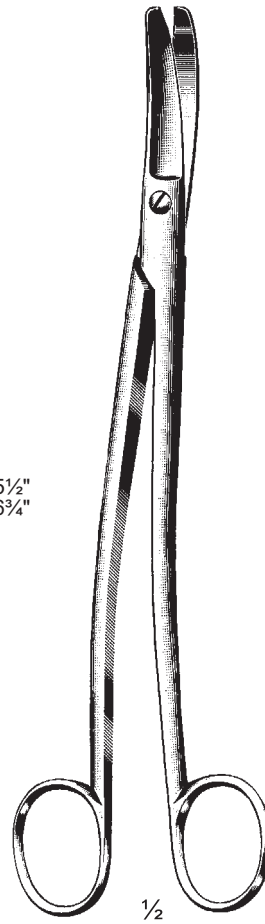

Siebold  
 84-09-24  
 24 cm / 9½"

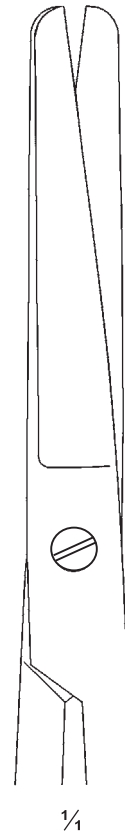

1/4

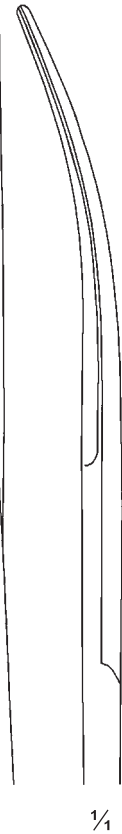

1/4

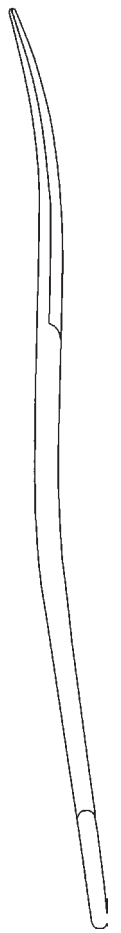

Mayo-Noble  
 84-05-14 14 cm / 5½"  
 84-06-17 17 cm / 6¾"

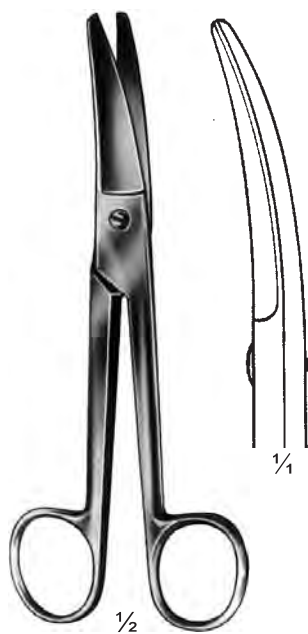

Mayo-Noble  
 84-07-14 14 cm / 5½"  
 84-08-17 17 cm / 6¾"

**Gynäkologische Scheren, Episiotomiesscheren**  
**Gynecological Scissors, Episiotomy Scissors**  
**Ciseaux à gynécologie, Ciseaux nasaux, Ciseaux à épisiotomie**

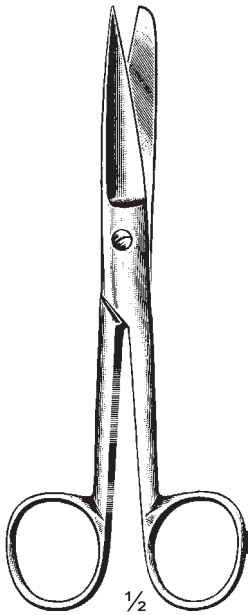

**85-01-16**  
16 cm / 6¼"

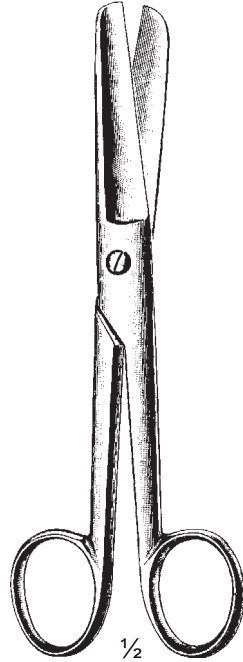

**85-02-16** 16 cm / 6¼"  
**85-03-18** 18 cm / 7"

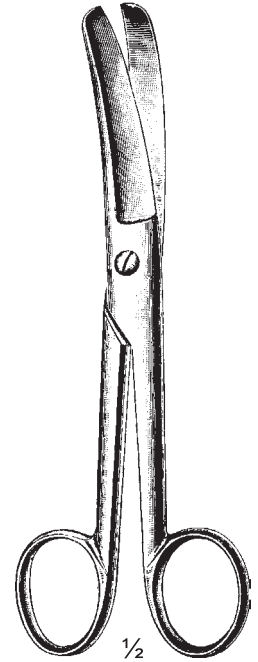

**85-04-16** 16 cm / 6¼"  
**85-05-18** 18 cm / 7"

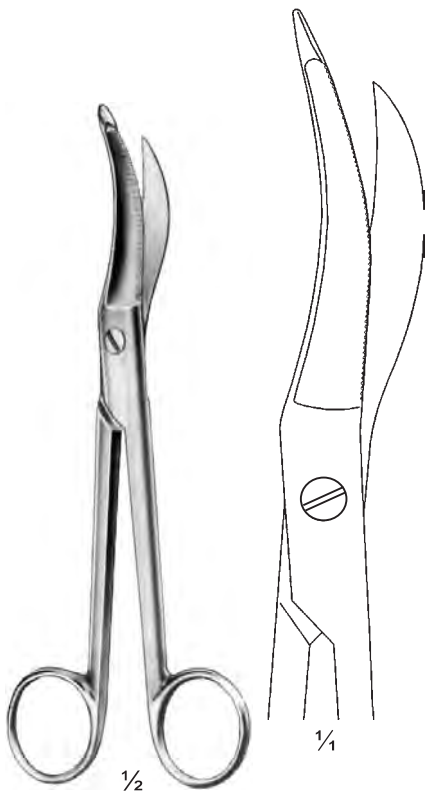

**Waldmann**  
**85-06-18**  
18 cm / 7"

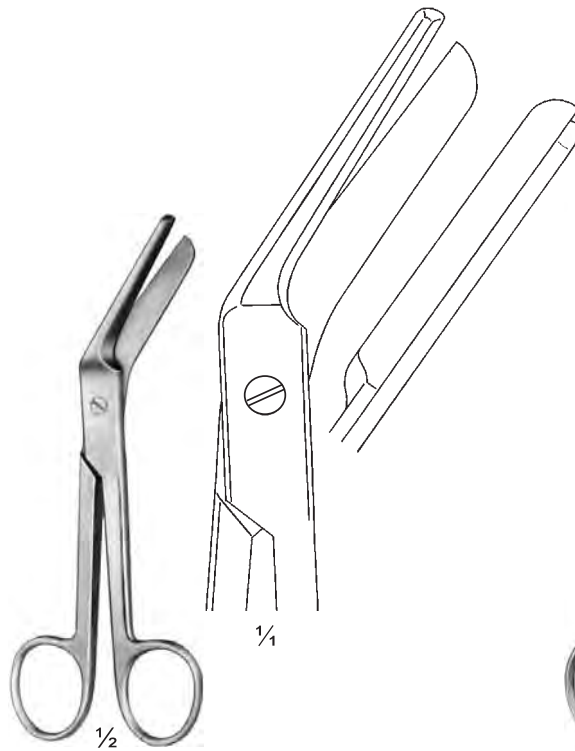

**Braun-Stadler**  
**85-07-14** 14.5 cm / 5¾"  
**85-08-16** 16 cm / 6¼"

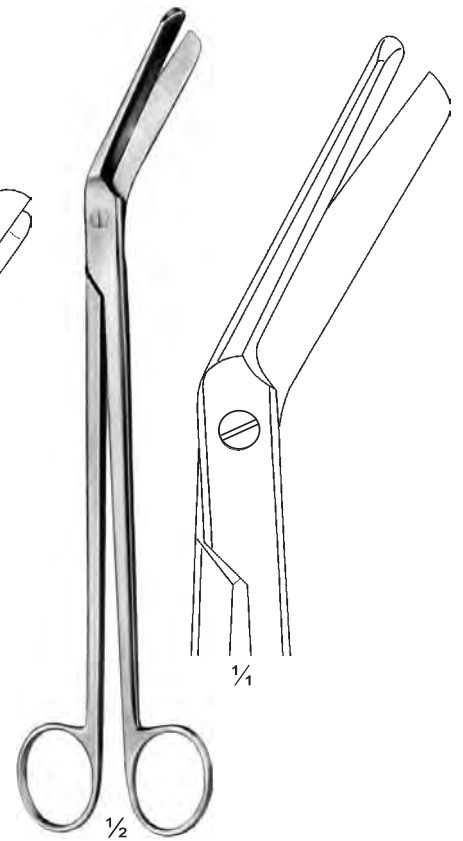

**Braun-Stadler**  
**85-09-22**  
22 cm / 8¾"

**Nabelschnurscheren, Zahnfleischscheren  
Umbilical & Gum Scissors  
Ciseaux pour le cordon ombilical, Ciseaux à gencives**

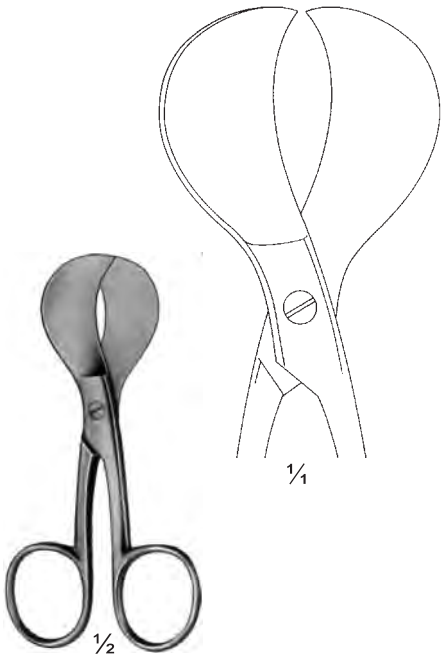

Mod. USA  
**86-01-10**  
10.5 cm / 4 1/8"



Schumacher  
**86-02-15**  
15.5 cm / 6 1/8"



**86-03-13 To  
86-04-16**

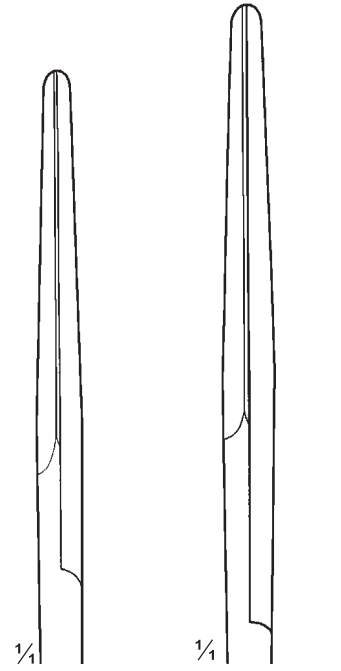

**86-03-13**  
13.5 cm / 5 1/4"

**86-04-16**  
16 cm / 6 1/4"

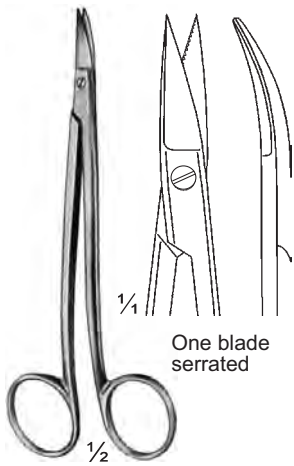

Nuemann  
**86-05**  
12 cm / 4 3/4"

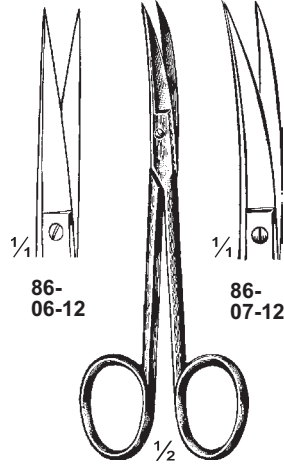

Wagner  
**86-06-12 To  
86-07-12**  
12 cm / 4 3/4"

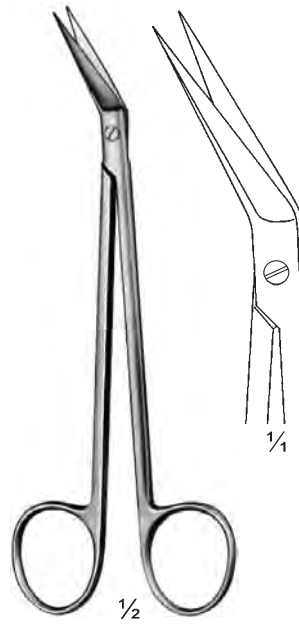

Locklin  
**86-08-16**  
16 cm / 6 1/4"

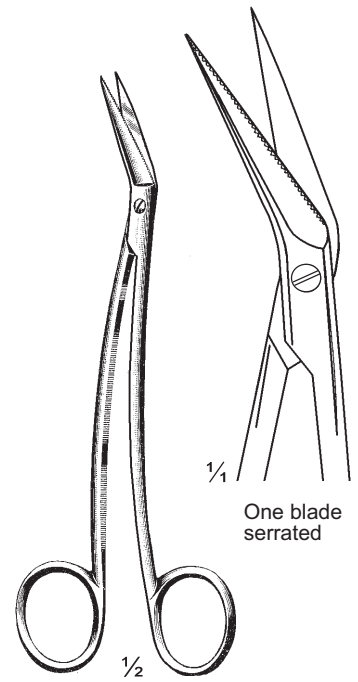

Locklin  
**86-09-19**  
16 cm / 6 1/4"

**Scheren mit Hartmetalleinlagen**  
**Scissors with tungsten carbide inserts**  
**Ciseaux avec plaquettes en carbure de tungstène**

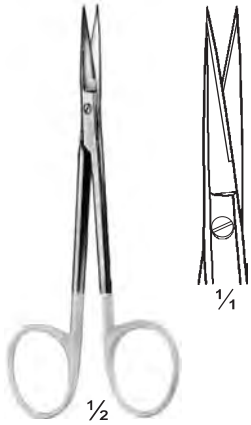

**Iris**  
**87-01-11**  
 11.5 cm / 4½"



**Iris**  
**87-02-11**  
 11.5 cm / 4½"

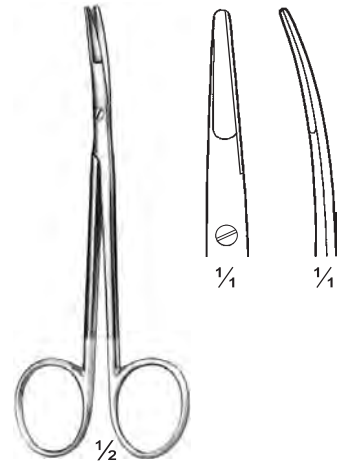

**Ragnell (Kilner)**  
**87-03-12**  
 12 cm / 4¾"

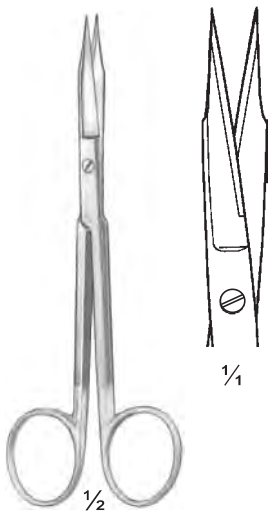

**Goldman-Fox**  
**87-04-13**  
 13 cm / 5¼"

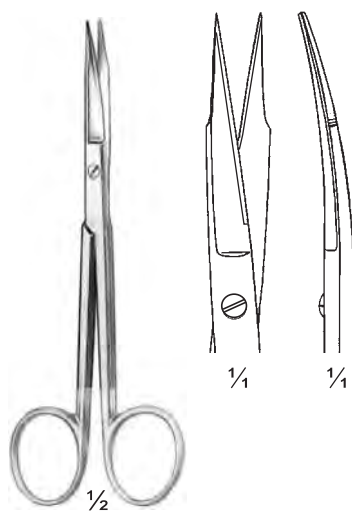

**Goldman-Fox**  
**87-05-13**  
 13 cm / 5¼"

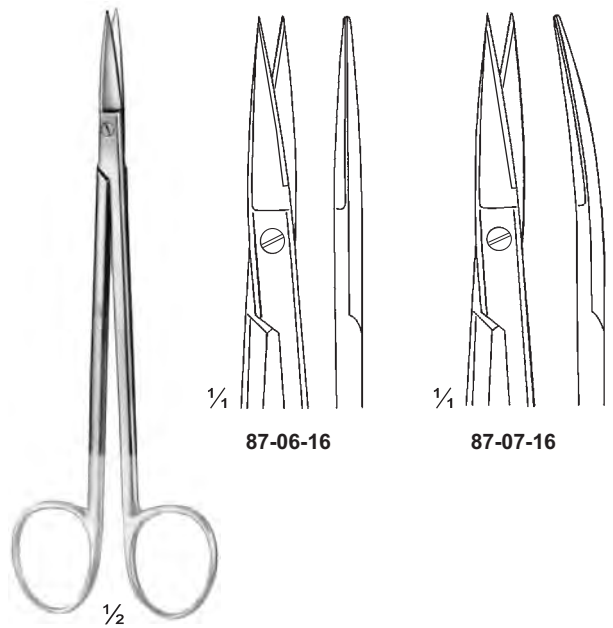

**Kelly**  
**87-06-16 To 87-07-16**  
 16 cm / 6¼"

**Scheren mit Hartmetalleinlagen**  
**Scissors with tungsten carbide inserts**  
**Ciseaux avec plaquettes en carbure de tungstène**

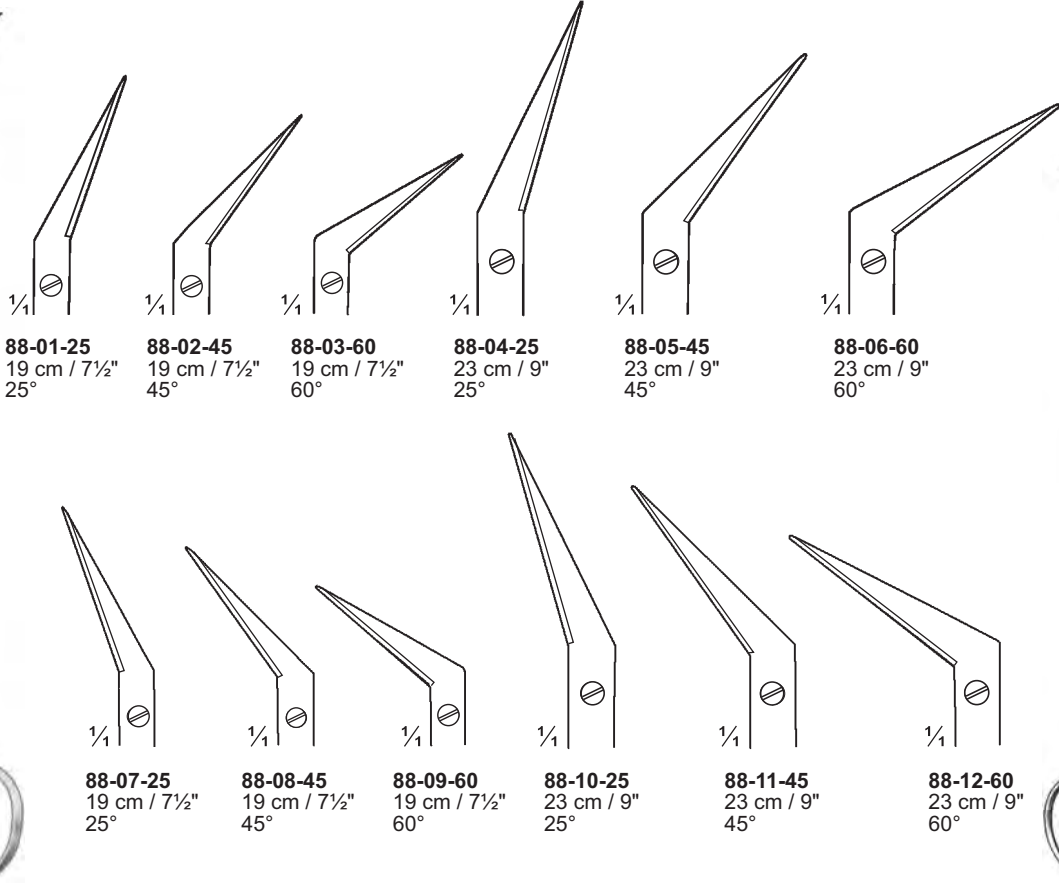

**88-01-25**  
19 cm / 7½"  
25°

**88-02-45**  
19 cm / 7½"  
45°

**88-03-60**  
19 cm / 7½"  
60°

**88-04-25**  
23 cm / 9"  
25°

**88-05-45**  
23 cm / 9"  
45°

**88-06-60**  
23 cm / 9"  
60°

**88-07-25**  
19 cm / 7½"  
25°

**88-08-45**  
19 cm / 7½"  
45°

**88-09-60**  
19 cm / 7½"  
60°

**88-10-25**  
23 cm / 9"  
25°

**88-11-45**  
23 cm / 9"  
45°

**88-12-60**  
23 cm / 9"  
60°

Potts-Smith  
88-01-25 To 88-06-60

Potts-Smith  
88-07-25 To 88-12-60

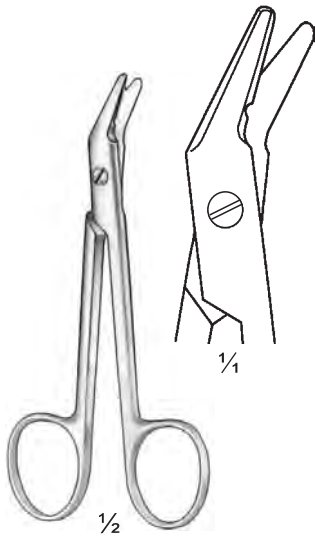

Universal  
**88-13-12**  
12 cm / 4¾"

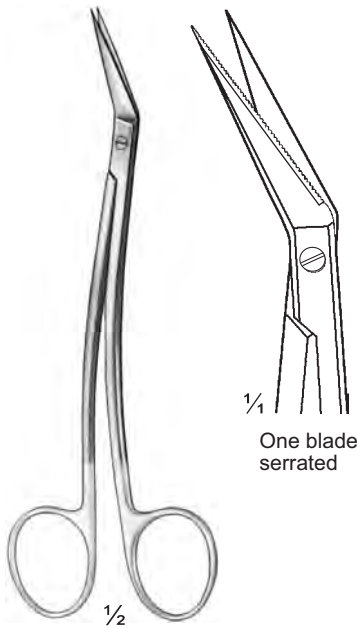

Locklin  
**88-14-16**  
16 cm / 6¼"

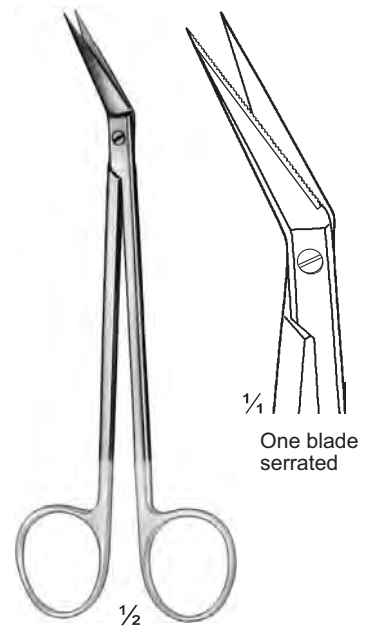

Locklin  
**88-15-16**  
16 cm / 6¼"



**Scheren mit Hartmetalleinlagen**  
**Scissors with tungsten carbide inserts**  
**Ciseaux avec plaquettes en carbure de tungstène**



1/2

De Bakey  
 89-01-25 To 89-12-60

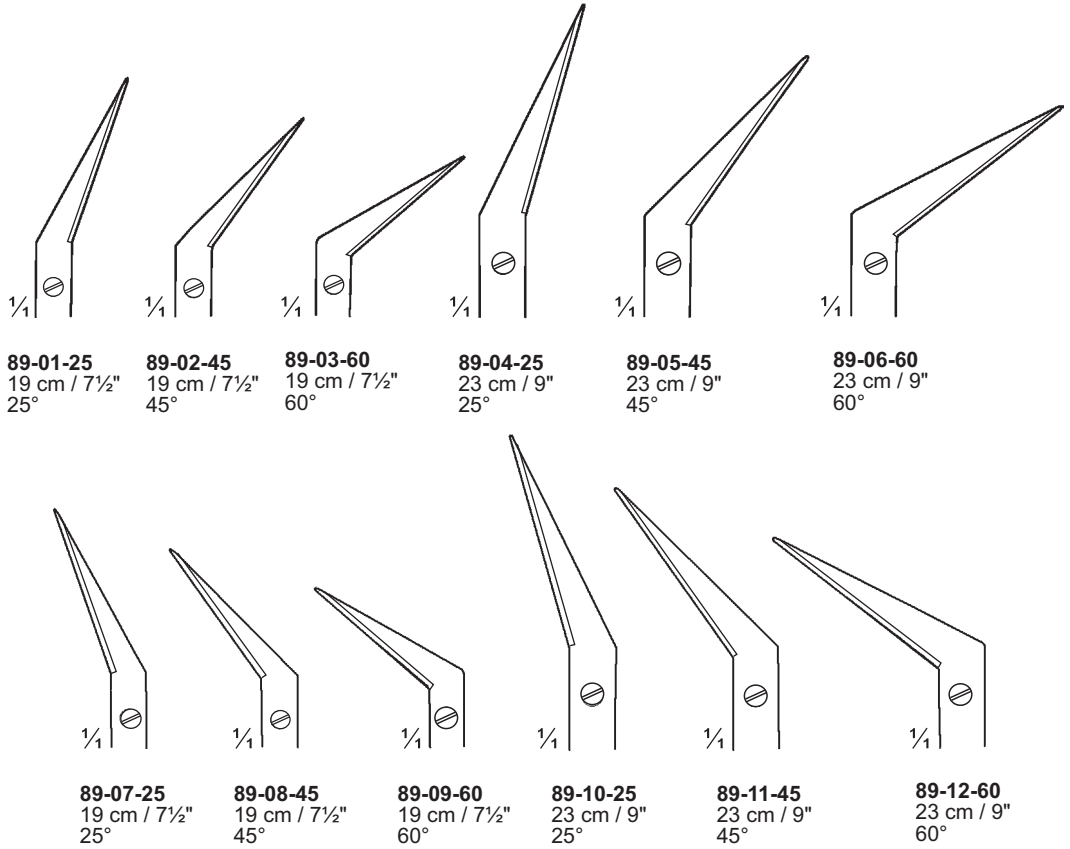

2/3

Lexer-Baby (Knapp)  
 89-13-10 10 cm / 4"  
 89-14-12 12 cm / 4 3/4"



1/4



2/3

Lexer-Baby (Knapp)  
 89-15-10 10 cm / 4"  
 89-16-12 12 cm / 4 3/4"



1/4

**Scheren mit Hartmetalleinlagen**  
**Scissors with tungsten carbide inserts**  
**Ciseaux avec plaquettes en carbure de tungstène**

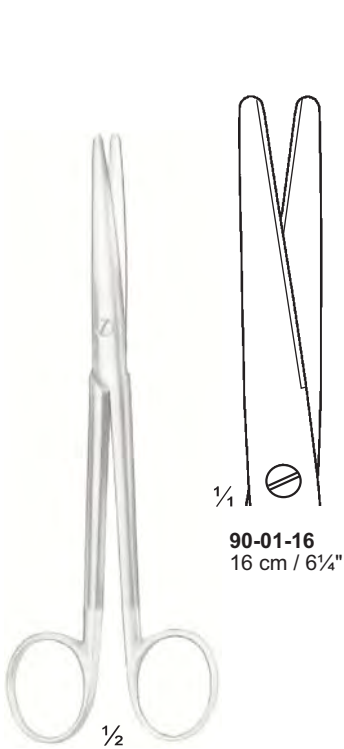

**90-01-16**  
16 cm / 6 1/4"

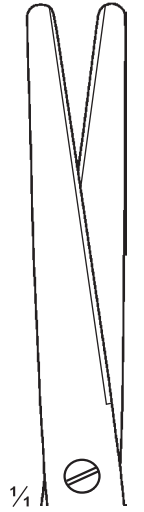

**90-02-21**  
21 cm / 8 1/4"



**90-03-16**  
16 cm / 6 1/4"



**90-04-21**  
21 cm / 8 1/4"

Lexer  
**90-01-16 & 90-02-21**

Lexer  
**90-03-16 & 90-04-21**

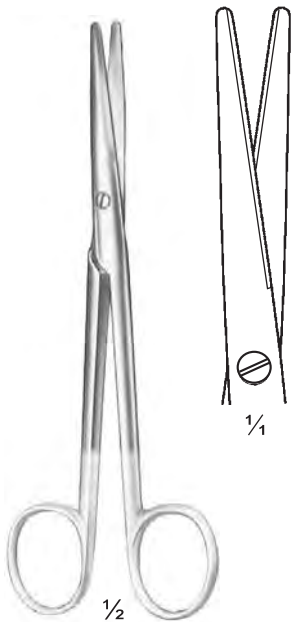

Mayo-Lexer  
**90-05-16**  
16 cm / 6 1/4"

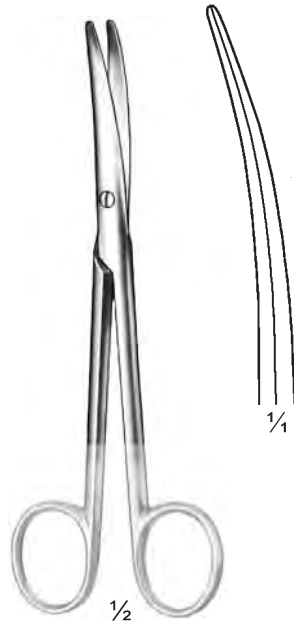

Mayo-Lexer  
**90-06-16**  
16 cm / 6 1/4"



**90-07-23**  
23 cm / 9"



**90-08-25**  
25 cm / 10"

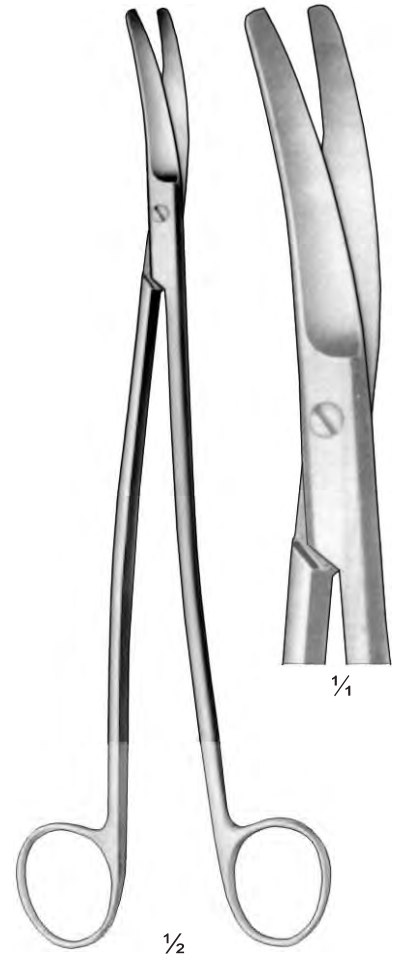

**90-07-23 & 90-08-25**

**Scheren mit Hartmetalleinlagen**  
**Scissors with tungsten carbide inserts**  
**Ciseaux avec plaquettes en carbure de tungstène**



Mayo  
 91-01-14 To 91-03-23



**91-01-14**  
 14.5 cm / 5 3/4"

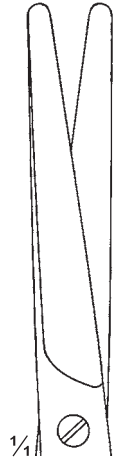

**91-02-18**  
 18 cm / 7"

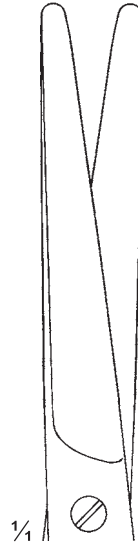

**91-03-23**  
 23 cm / 9"



Mayo  
 91-04-14 To 91-06-23



**91-04-14**  
 14.5 cm / 5 3/4"



**91-05-18**  
 18 cm / 7"



**91-06-23**  
 23 cm / 9"



**91-07-26**  
 26 cm / 10 1/4"  
 One ring black and  
 one goldplated



**Scheren mit Hartmetalleinlagen**  
**Scissors with tungsten carbide inserts**  
**Ciseaux avec plaquettes en carbure de tungstène**



**92-01-15**  
15 cm / 6"

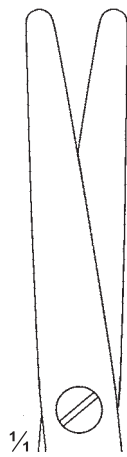

**92-02-17**  
17 cm / 6 3/4"

Mayo-Style  
92-01-15 & 92-02-17



**92-03-15**  
15 cm / 6"



**92-04-17**  
17 cm / 6 3/4"

Mayo-Style  
92-03-15 & 92-04-17



**92-05-12**  
Sh/Bl



**92-06-12**  
Sh/Sh



**92-07-12**  
Sh/Bl



**92-08-12**  
Sh/Sh

**92-05-12 To 92-08-12**  
12 cm / 4 3/4"

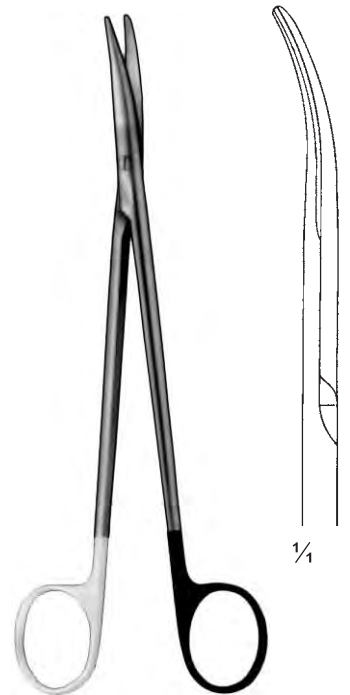

**92-09-18**  
18 cm / 7"  
One ring black and  
one goldplated

**Scheren mit Hartmetalleinlagen**  
**Scissors with tungsten carbide inserts**  
**Ciseaux avec plaquettes en carbure de tungstène**



Mayo-Harrington  
**93-01-28**  
 28 cm / 11"

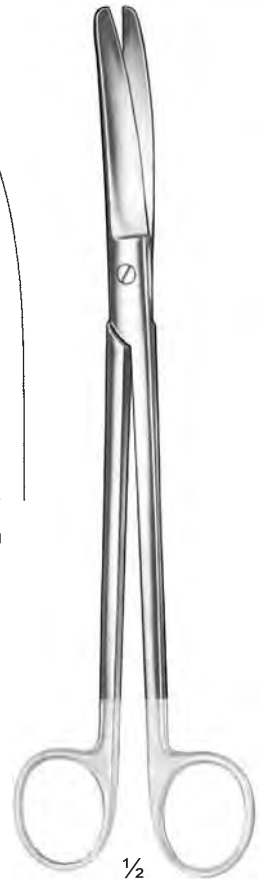
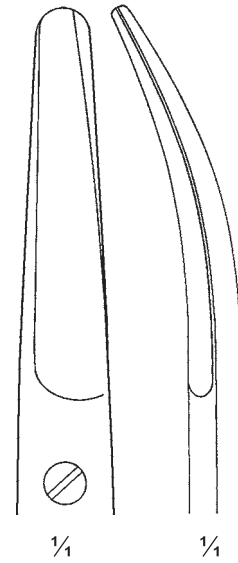
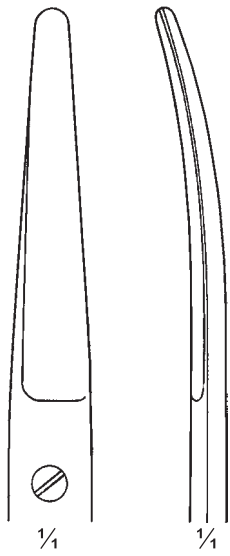

Sims  
**93-06-23**  
 23 cm / 9"

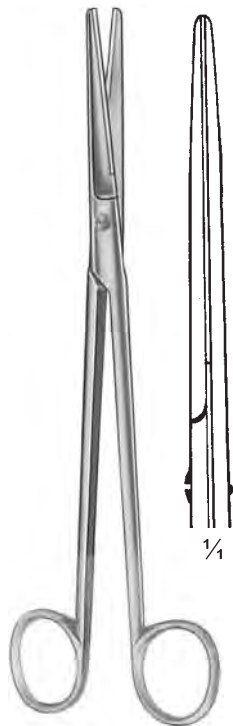

Mayo-Harrington  
**93-02-20** 20 cm / 8"  
**93-03-23** 23 cm / 9"

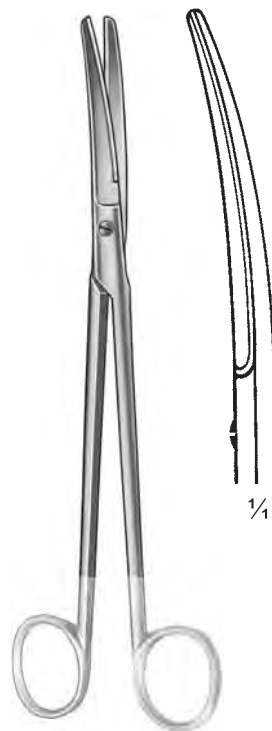

Mayo-Harrington  
**93-04-20** 20 cm / 8"  
**93-05-23** 23 cm / 9"

**Scheren mit Hartmetalleinlagen**  
**Scissors with tungsten carbide inserts**  
**Ciseaux avec plaquettes en carbure de tungstène**



Metzenbaum  
**94-01-18 To 94-06-30**



**94-01-18**  
 18 cm / 7"



**94-02-20**  
 20 cm / 8"



**94-03-23**  
 23 cm / 9"



**94-04-25**  
 25 cm / 10"



**94-05-28**  
 28 cm / 11"



**94-06-30**  
 30 cm / 12"

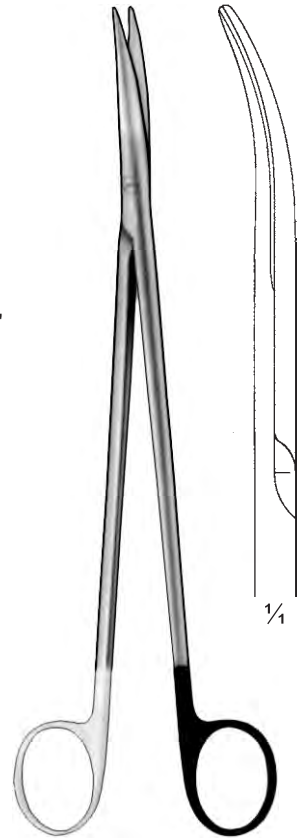

**94-13-23**  
 23 cm / 9"  
 One ring black and  
 one goldplated



Metzenbaum  
**94-07-18 To 94-12-30**  
 BI/BI



**94-07-18**  
 18 cm / 7"



**94-08-20**  
 20 cm / 8"



**94-09-23**  
 23 cm / 9"



**94-10-10**  
 25 cm / 10"



**94-11-28**  
 28 cm / 11"



**94-12-30**  
 30 cm / 12"



**Scheren mit Hartmetalleinlagen**  
**Scissors with tungsten carbide inserts**  
**Ciseaux avec plaquettes en carbure de tungstène**



Metzenbaum-Fino  
 95-01-14 To 95-06-28

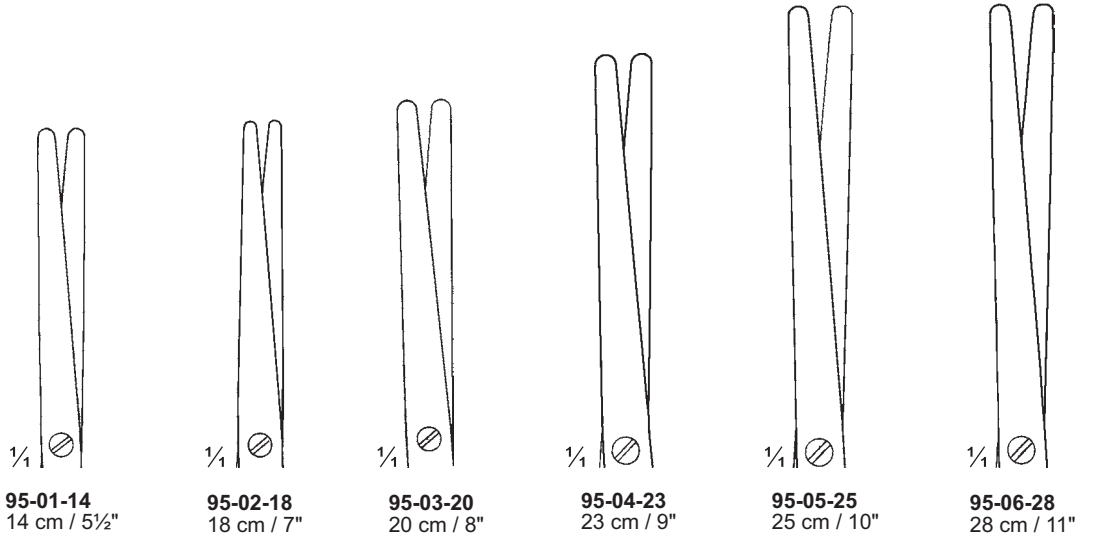

Metzenbaum-Fino  
 95-07-14 To 95-12-28  
 BI/BI

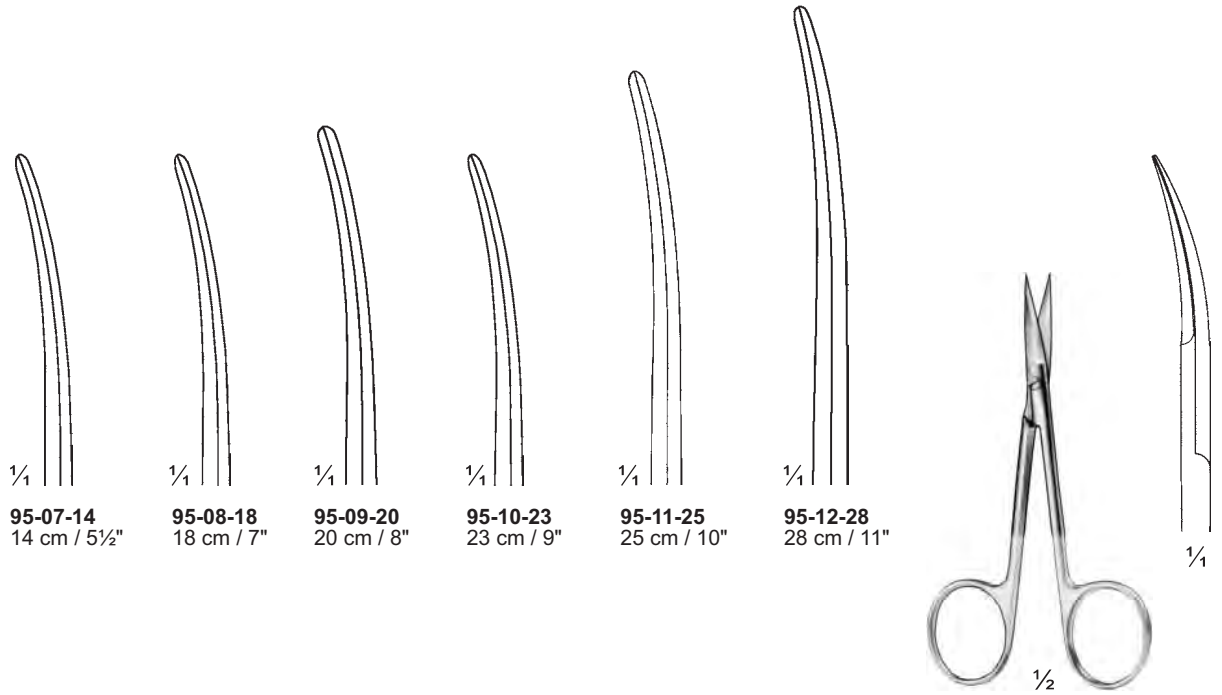

**95-13-11**  
 11 cm / 4¼"  
 One blade serrated

**Scheren mit Hartmetalleinlagen**  
**Scissors with tungsten carbide inserts**  
**Ciseaux avec plaquettes en carbure de tungstène**



**Metzenbaum-Fino**  
**96-01-14 To 96-04-23**



**96-01-14**  
 14 cm / 5½"



**96-02-18**  
 18 cm / 7"



**96-03-20**  
 20 cm / 8"



**96-04-23**  
 23 cm / 9"



**96-05-11 & 96-06-11**  
 11 cm / 4¼"



**96-05-11**



**96-06-11**

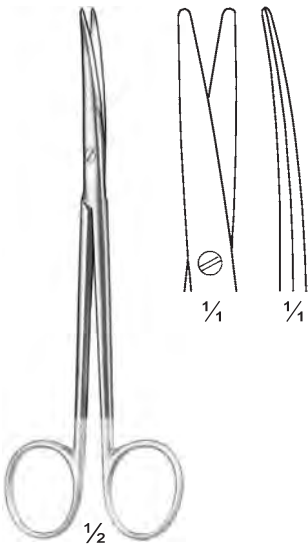

**Metzenbaum-Lahey**  
**96-07-14**  
 14 cm / 5¾"

**Metzenbaum-Lahey**  
**96-07-145**  
 14.5 cm / 5¾"



**1/4**

**1/4**

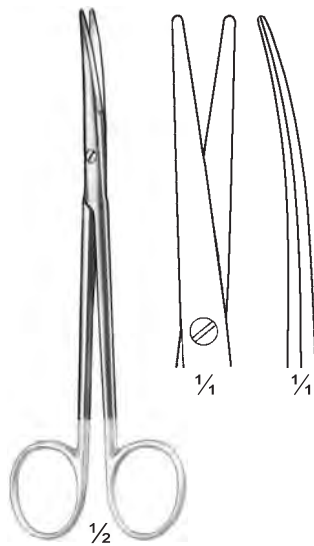

**Toennis-Adson**  
**96-08-18**  
 18 cm / 7"

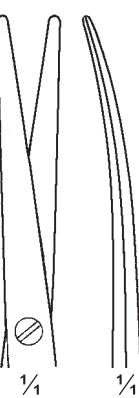

**1/4**

**1/4**



**Metzenbaum**  
**96-09-20 & 96-10-23**

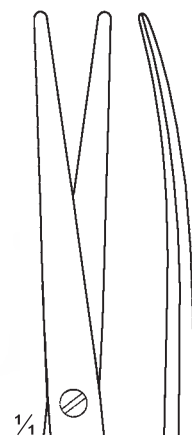

**96-09-20**  
 20 cm / 8"

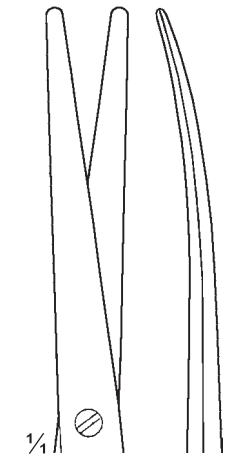

**96-10-23**  
 23 cm / 9"

**Scheren mit Hartmetalleinlagen**  
**Scissors with tungsten carbide inserts**  
**Ciseaux avec plaquettes en carbure de tungstène**



Metzenbaum-Fino  
 97-01-14 To 97-04-23

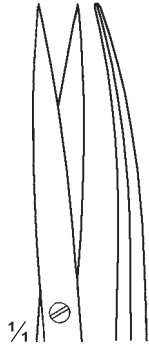

**97-01-14**  
 14 cm / 5½"

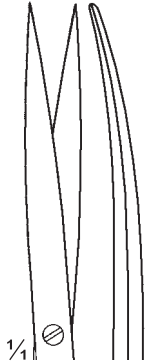

**97-02-18**  
 18 cm / 7"

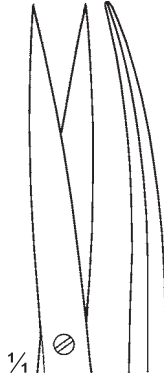

**97-03-20**  
 20 cm / 8"



**97-04-23**  
 23 cm / 9"

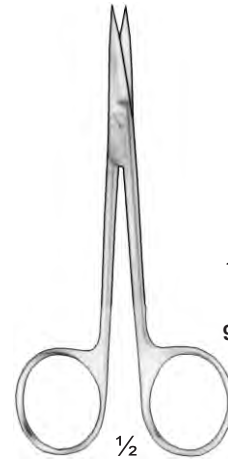

**97-05-12 & 97-06-12**  
 12 cm / 4¾"

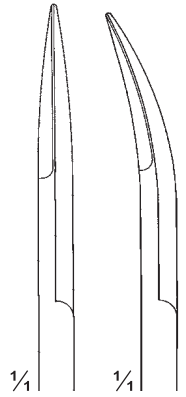

**97-05-12 97-06-12**



Metzenbaum-Thorek  
 97-07-20 To 97-09-28

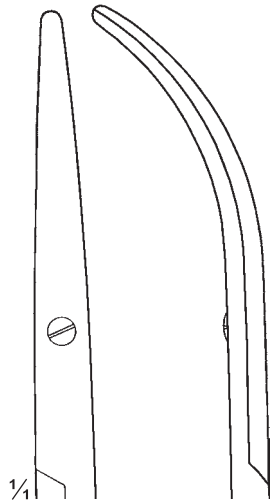

**97-07-20**  
 20 cm / 8"

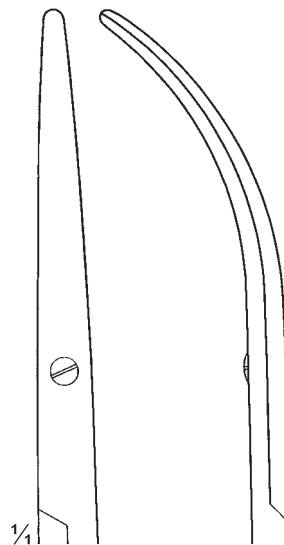

**97-08-23**  
 23 cm / 9"

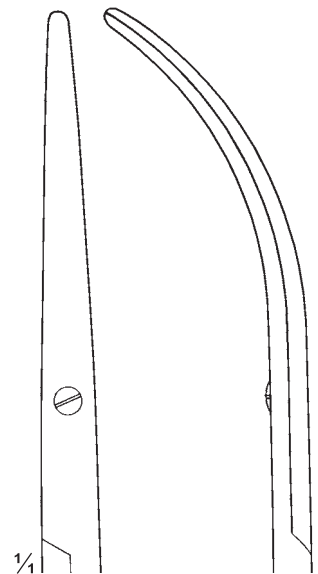

**97-09-28**  
 28 cm / 11"

**Scheren mit Hartmetalleinlagen**  
**Scissors with tungsten carbide inserts**  
**Ciseaux avec plaquettes en carbure de tungstène**

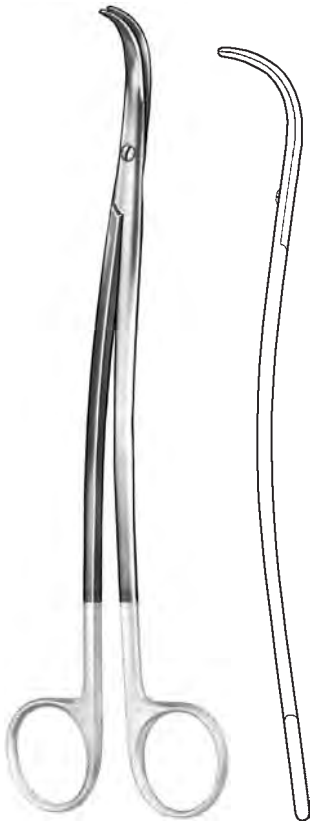

Metzenbaum-S  
 98-01-20 To 98-04-28

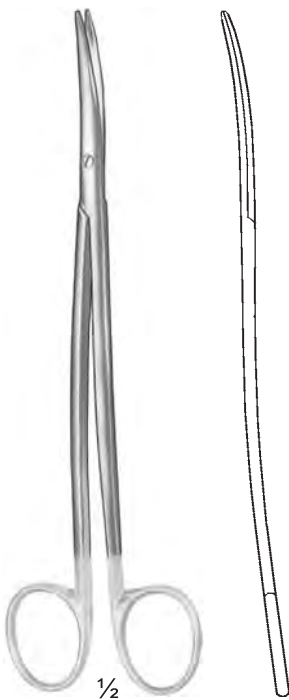
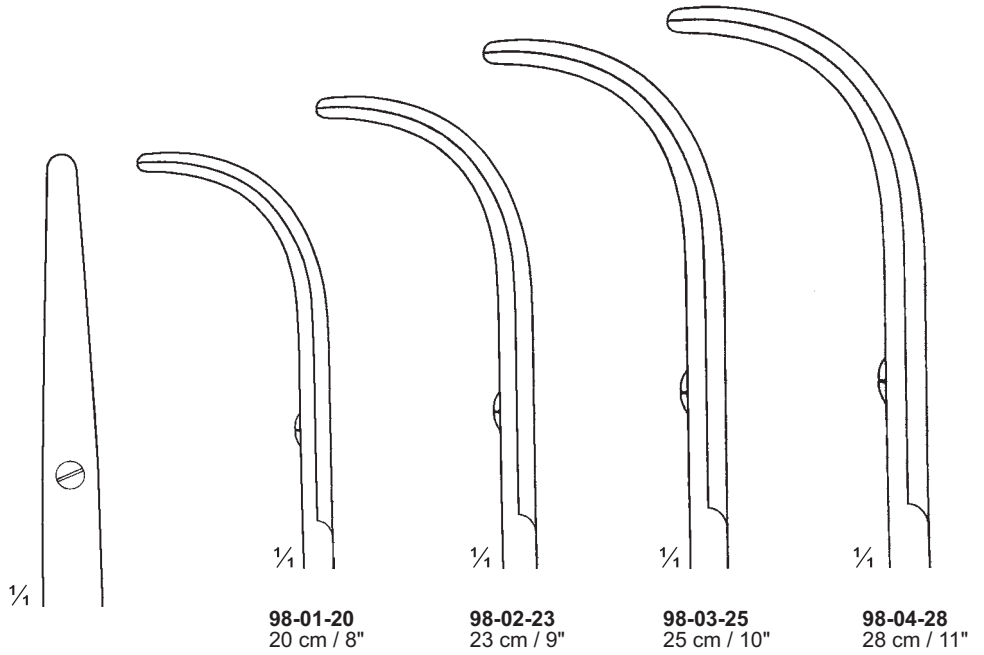

Metzenbaum-Fino  
 98-05-18 To 98-07-23

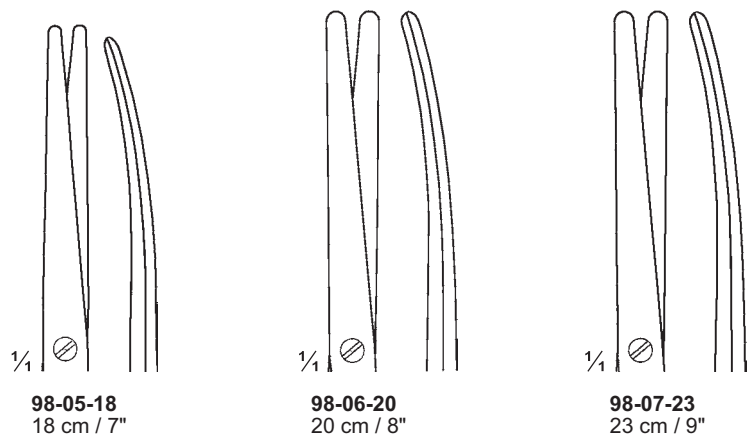

**Scheren mit Hartmetalleinlagen**  
**Scissors with tungsten carbide inserts**  
**Ciseaux avec plaquettes en carbure de tungstène**

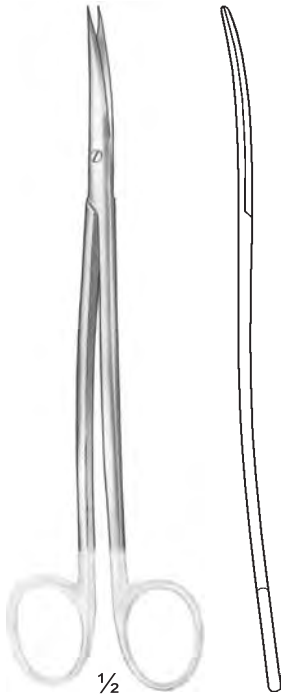

**Metzenbaum-Fino**  
**99-01-18 To 99-03-23**

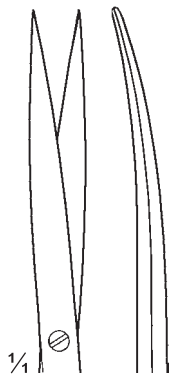

**99-01-18**  
 18 cm / 7"



**99-02-20**  
 20 cm / 8"

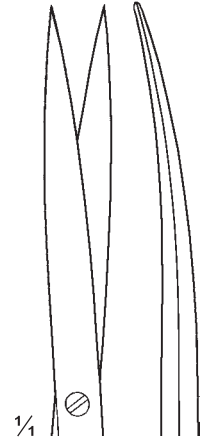

**99-03-23**  
 23 cm / 9"

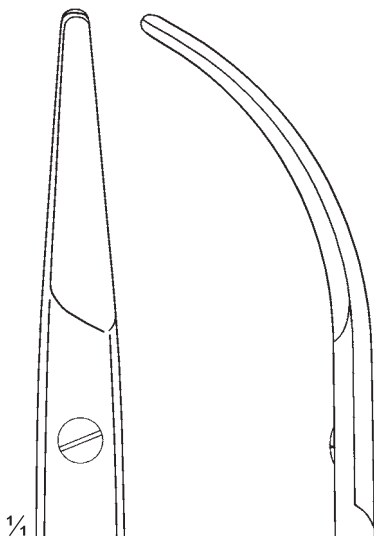

**99-04-23**  
 23 cm / 9"

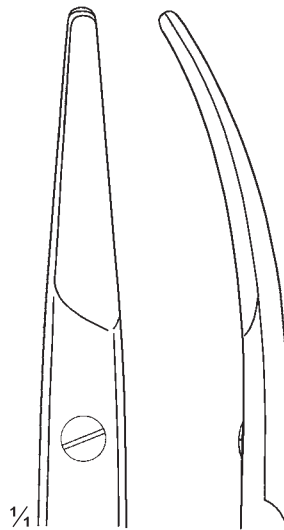

**99-05-23**  
 23 cm / 9"



**Parametrium**  
**99-04-23 & 99-05-23**

**Scheren mit Hartmetalleinlagen**  
**Scissors with tungsten carbide inserts**  
**Ciseaux avec plaquettes en carbure de tungstène**



Standard  
**100-01-15 To 100-06-18**



**100-01-15**  
**100-07-15**  
 15 cm / 6"



**100-02-16**  
**100-08-16**  
 16.5 cm / 6½"



**100-03-18**  
**100-09-18**  
 18.5 cm / 7½"



**100-04-15**  
**100-10-15**  
 15 cm / 6"



**100-05-16**  
**100-11-16**  
 16.5 cm / 6½"



**100-06-18**  
**100-12-18**  
 18.5 cm / 7½"



Standard  
**100-07-15 To 100-12-18**



Standard  
**100-13-15 To 100-18-18**



**100-13-15**  
**100-19-15**  
 15 cm / 6"

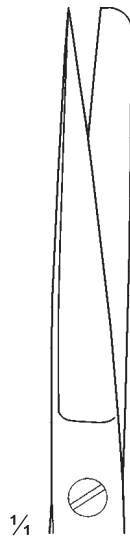

**100-14-16**  
**100-20-16**  
 16.5 cm / 6½"



**100-15-18**  
**100-21-18**  
 18.5 cm / 7½"



**100-16-15**  
**100-22-15**  
 15 cm / 6"



**100-17-16**  
**100-23-16**  
 16.5 cm / 6½"



**100-18-18**  
**100-24-18**  
 18.5 cm / 7½"

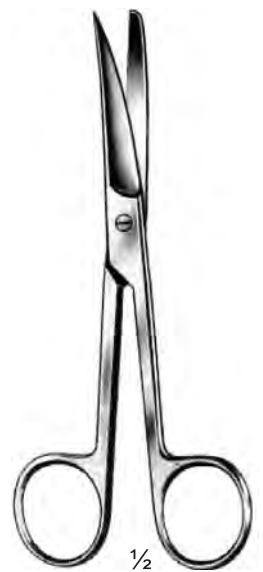

Standard  
**100-19-15 To 100-24-18**



**Scheren mit Hartmetalleinlagen**  
**Scissors with tungsten carbide inserts**  
**Ciseaux avec plaquettes en carbure de tungstène**

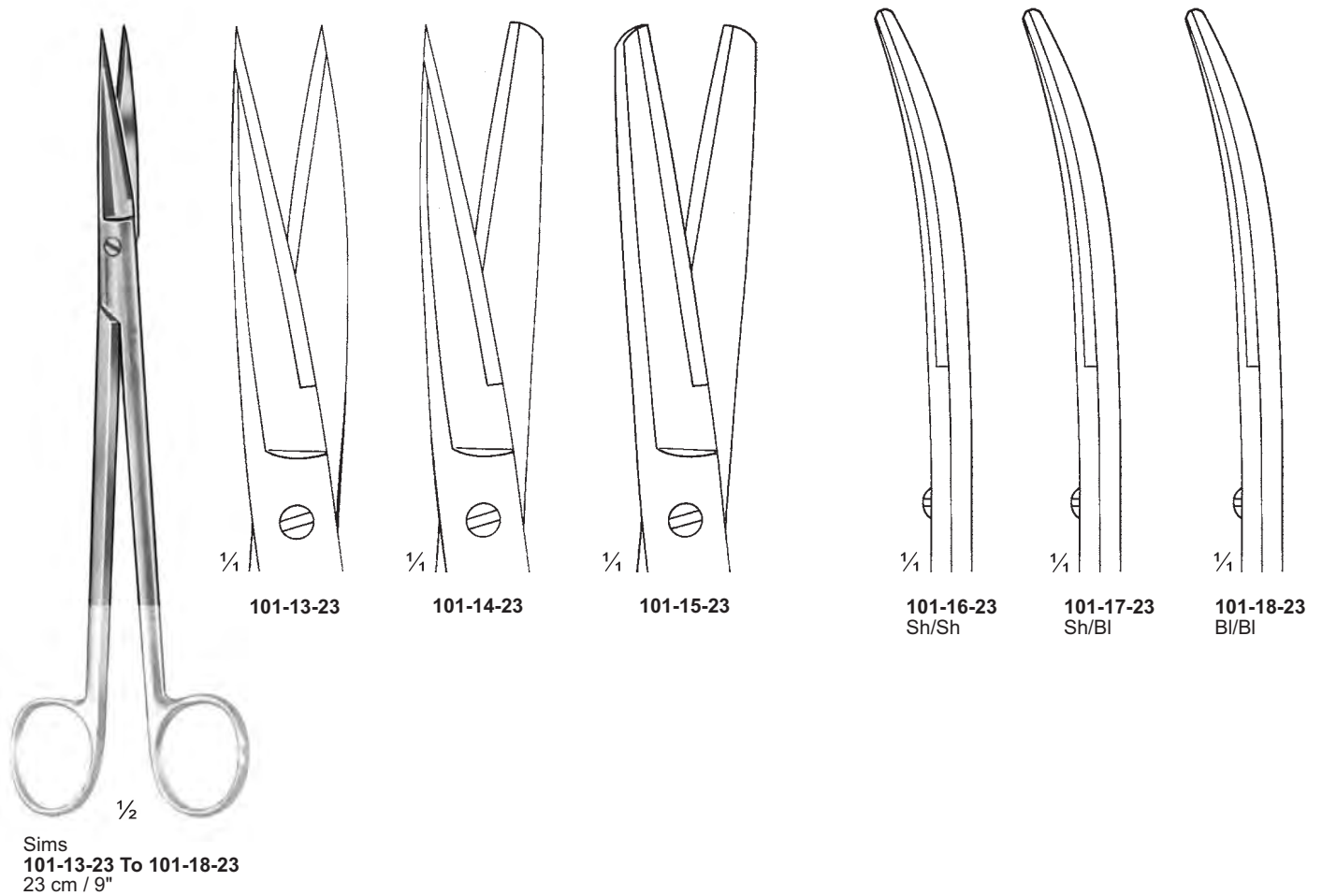
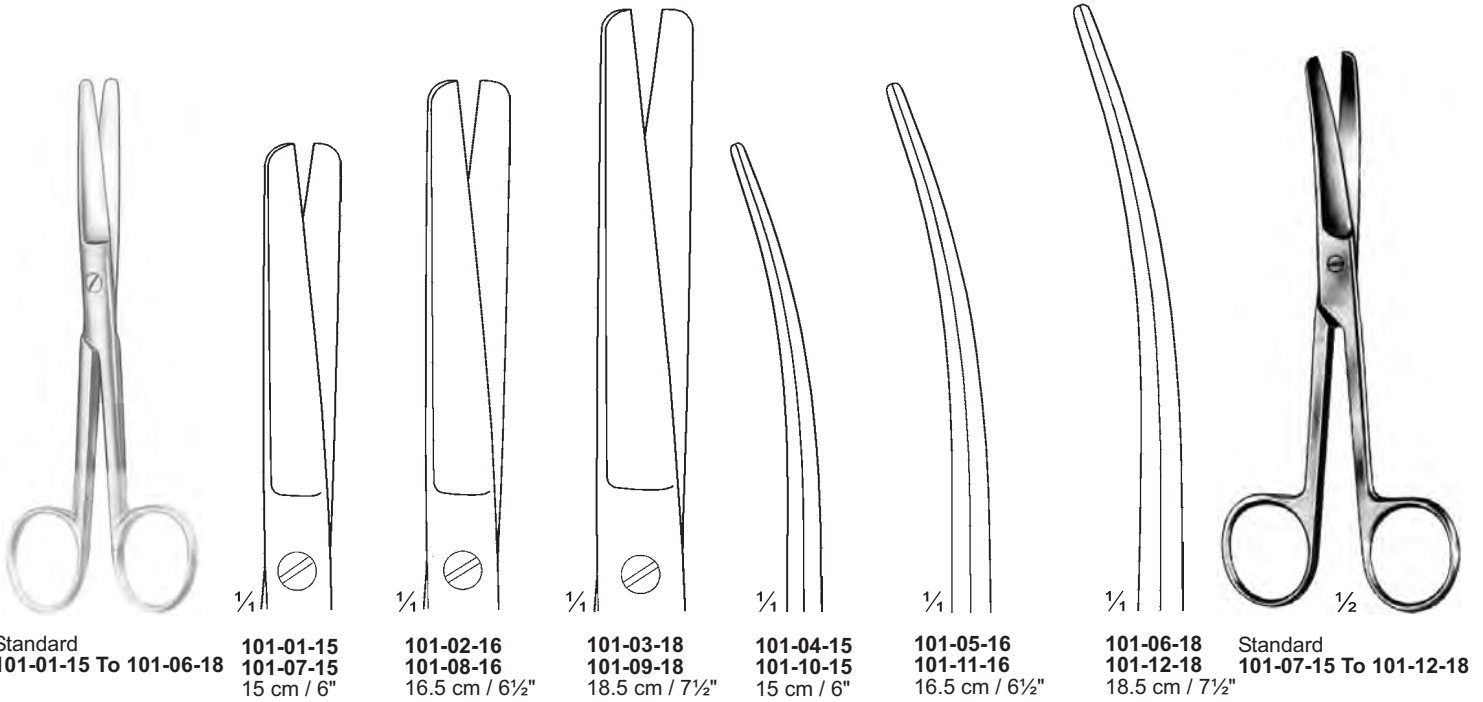

**Scheren mit Hartmetalleinlagen**  
**Scissors with tungsten carbide inserts**  
**Ciseaux avec plaquettes en carbure de tungstène**

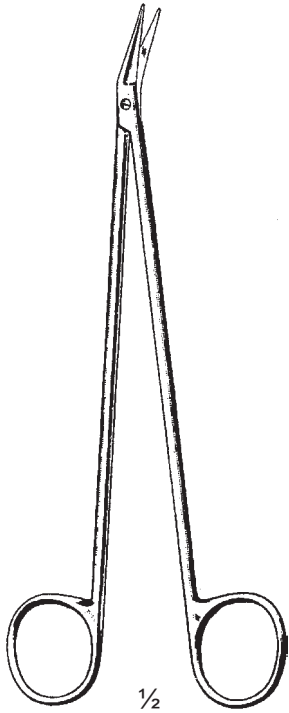

Potts-De Martel  
 102-01-25 To 102-03-60

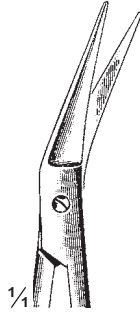

**102-01-25**  
 19 cm / 7½"  
 25°

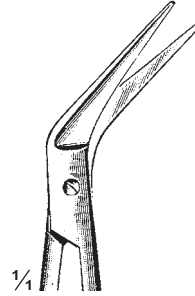

**102-02-40**  
 19 cm / 7½"  
 40°

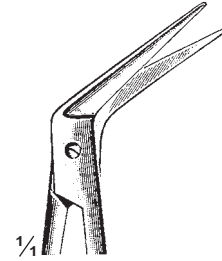

**102-03-60**  
 19 cm / 7½"  
 60°



Dietrich  
 102-04-25 To 102-08-125

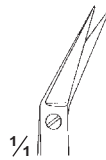

**102-04-25**  
 18 cm / 7"  
 25°

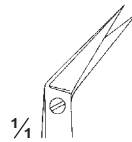

**102-05-45**  
 18 cm / 7"  
 45°

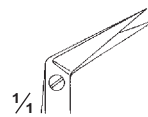

**102-06-60**  
 18 cm / 7"  
 60°

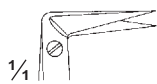

**102-07-90**  
 17 cm / 6¾"  
 90°

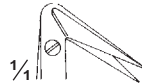

**102-08-125**  
 17 cm / 6¾"  
 125°



Dietrich  
 102-09-17  
 17 cm / 6¾"

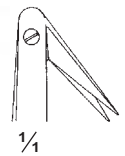

**Scheren mit Hartmetalleinlagen**  
**Scissors with tungsten carbide inserts**  
**Ciseaux avec plaquettes en carbure de tungstène**

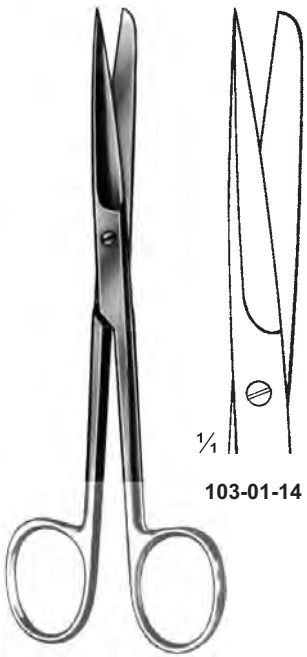

**103-01-14**

Deaver  
**103-01-14 & 103-02-14**  
 14 cm / 5½"

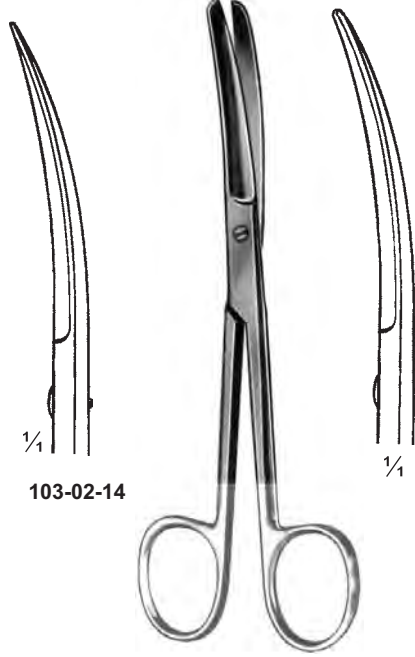

**103-02-14**



Deaver  
**103-03-14**  
 14 cm / 5½"

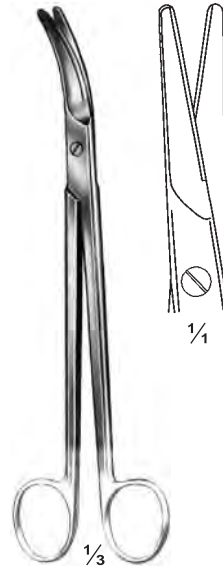

**103-04-22 & 103-05-23**

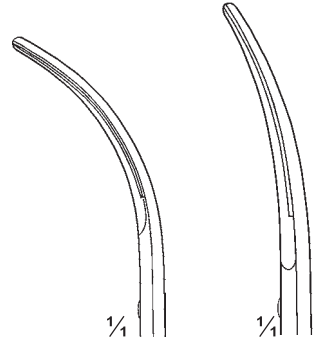

**103-04-22**    **103-05-23**  
 22.5 cm / 8¾"    23 cm / 9"

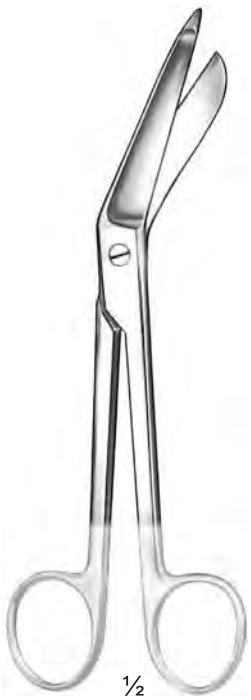

Lister  
**103-06-14** 14 cm / 5½"  
**103-07-15** 15 cm / 6"  
**103-08-18** 18 cm / 7"  
**103-09-20** 20 cm / 8"  
**103-10-23** 23 cm / 9"

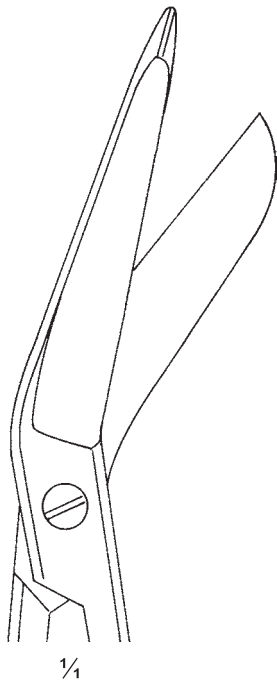

Bruns  
**103-11-24**  
 24 cm / 9½"

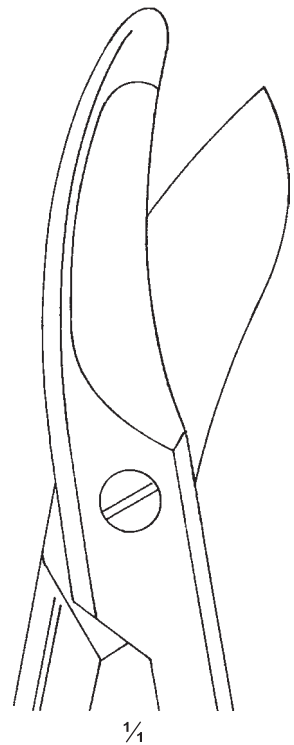

## Verbandscheren Bandage Scissors Ciseaux pour pansements

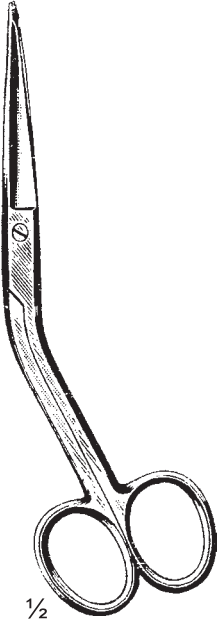

**104-01-16**  
16 cm / 6¼"

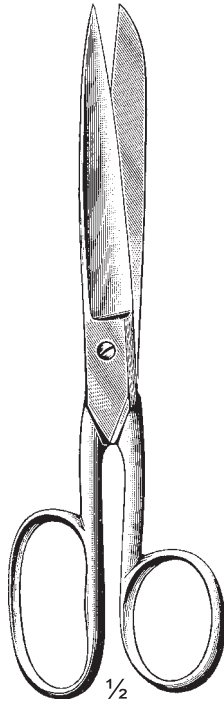

Smith  
**104-02-15** 15 cm / 6"  
**104-03-18** 18 cm / 7"  
**104-04-20** 20 cm / 8"  
**104-05-23** 23 cm / 9"

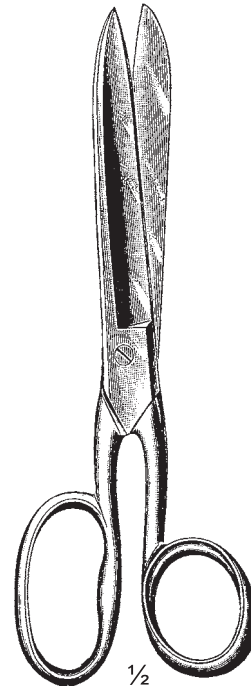

Smith  
**104-06-15** 15 cm / 6"  
**104-07-18** 18 cm / 7"  
**104-08-20** 20 cm / 8"  
**104-09-23** 23 cm / 9"

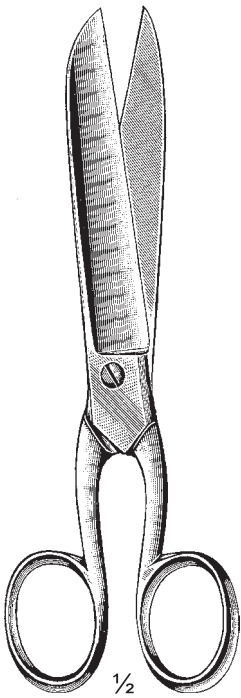

Schweizer  
**104-10-18** 18 cm / 7"  
**104-11-20** 20 cm / 8"  
**104-12-23** 23 cm / 9"

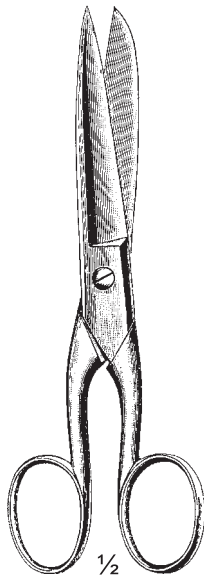

**104-13-10** 10 cm / 4"  
**104-14-12** 12.5 cm / 5"  
**104-15-15** 15 cm / 6"  
**104-16-18** 18 cm / 7"  
**104-17-20** 20 cm / 8"

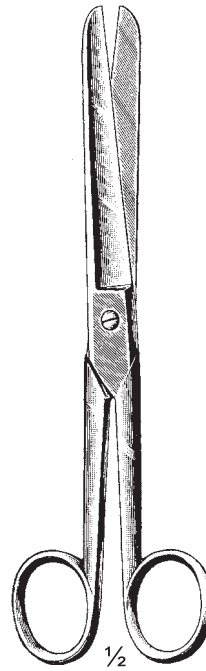

Lange  
**104-18-18** 18 cm / 7"  
**104-19-20** 20 cm / 8"

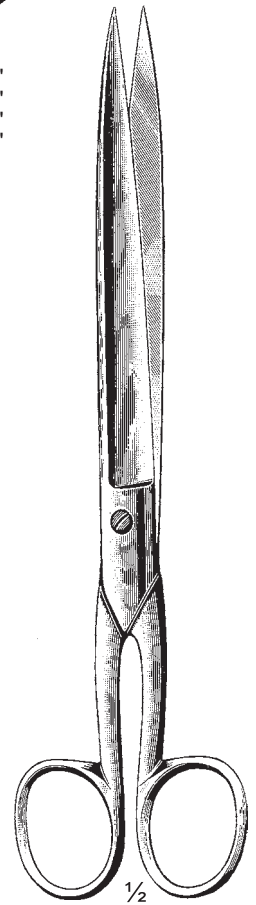

**104-20-20** 20 cm / 8"  
**104-21-23** 23 cm / 9"  
**104-22-25** 25 cm / 10"

**Verbandscheren  
Bandage Scissors  
Ciseaux pour pansements**

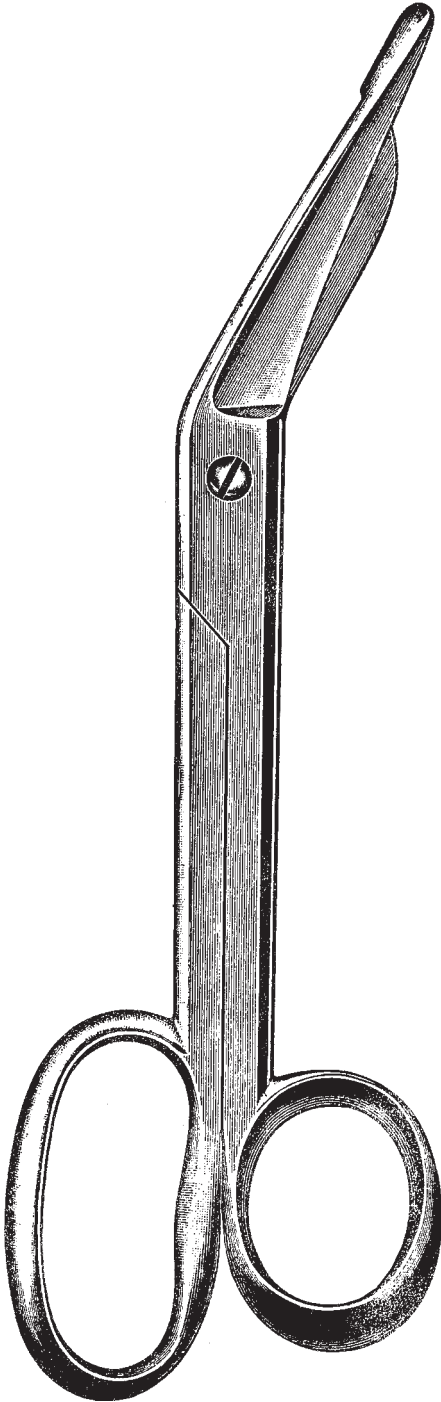

Lister  
**105-01-14** 14 cm / 5½"  
**105-02-16** 16 cm / 6¼"  
**105-03-18** 18 cm / 7"  
**105-04-20** 20 cm / 8"



105-05-16 16.5 cm / 6½"  
 105-06-18 18 cm / 7"



105-07-14 14 cm / 5½"  
 105-08-17 17 cm / 6¾"

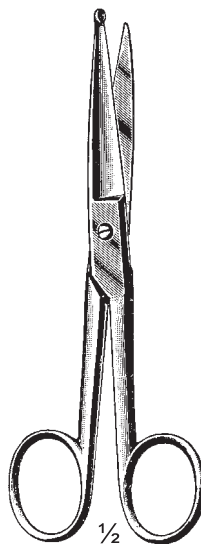

Knowles  
**105-09-14**  
 14.5 cm / 5¾"

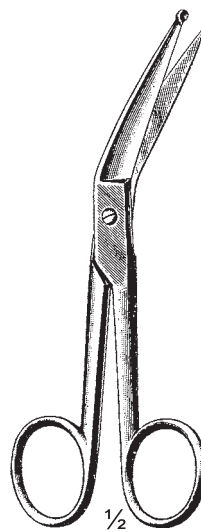

Knowles  
**105-10-14** 14 cm / 5½"  
**105-11-15** 15 cm / 6"

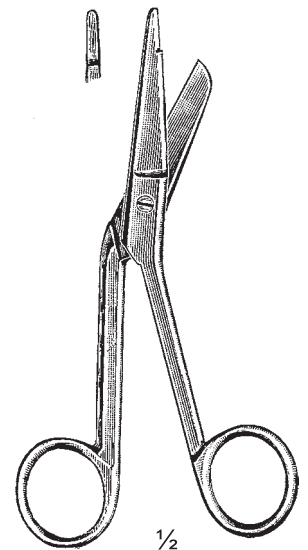

Lister  
**105-12-15**  
 15 cm / 6"  
 Sheffield Pattern

## Verbandscheren Bandage Scissors Ciseaux pour pansements

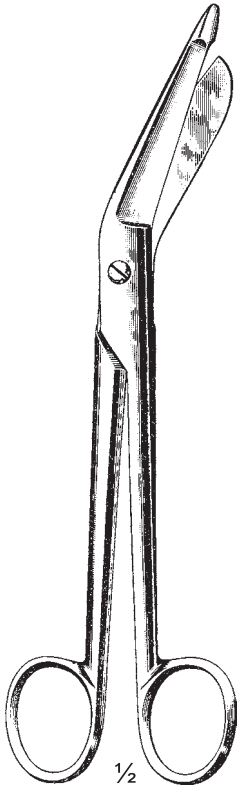

**Lister**  
**106-01-11** 11.5 cm / 4½"  
**106-02-14** 14 cm / 5½"  
**106-03-15** 15 cm / 6"  
**106-04-18** 18 cm / 7"  
**106-05-20** 20 cm / 8"  
**106-06-23** 23 cm / 9"

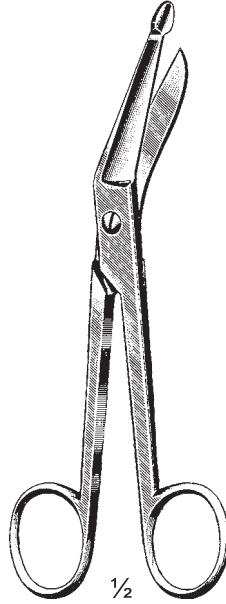

**Lister**  
**106-07-09** 9 cm / 3½"  
**106-08-10** 10.5 cm / 4¼"  
**106-09-11** 11.5 cm / 4½"  
**106-10-14** 14 cm / 5½"  
**106-11-15** 15 cm / 6"  
**106-12-17** 17 cm / 6¾"  
**106-13-18** 18 cm / 7"  
**106-14-20** 20 cm / 8"  
**106-15-23** 23 cm / 9"

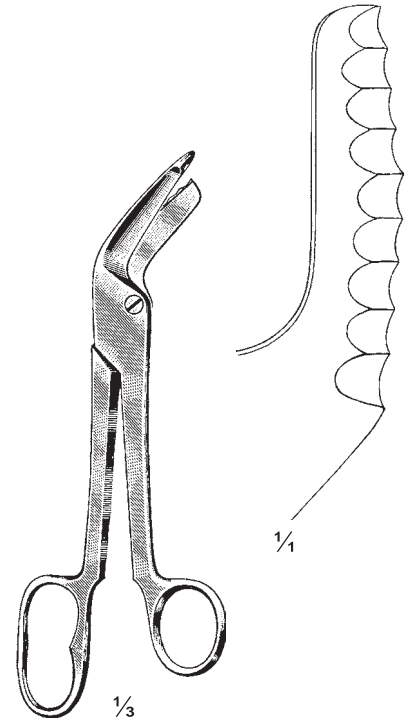

**Tornado**  
**106-16-24**  
 24 cm / 9½"

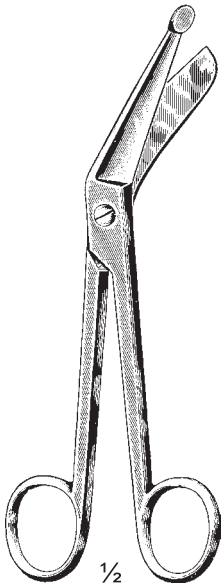

**Bergmann**  
**106-17-15** 15 cm / 6"  
**106-18-18** 18 cm / 7"  
**106-19-20** 20 cm / 8"  
**106-20-23** 23 cm / 9"

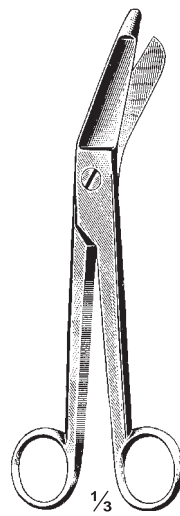

**Esmarch**  
**106-21-18** 18 cm / 7"  
**106-22-20** 20 cm / 8"  
**106-23-23** 23 cm / 9"

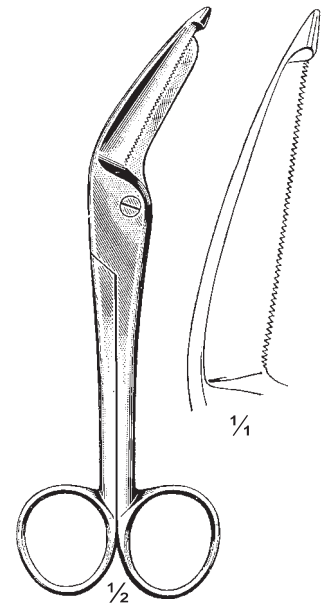

**Lister Excentric**  
**106-24-16** 16 cm / 6¼"  
**106-25-19** 19 cm / 7½"



**Verbandscheren  
Bandage Scissors  
Ciseaux pour pansements**



Lister  
107-01-14 14 cm / 5½"  
107-02-18 18 cm / 7"  
Available in different colours

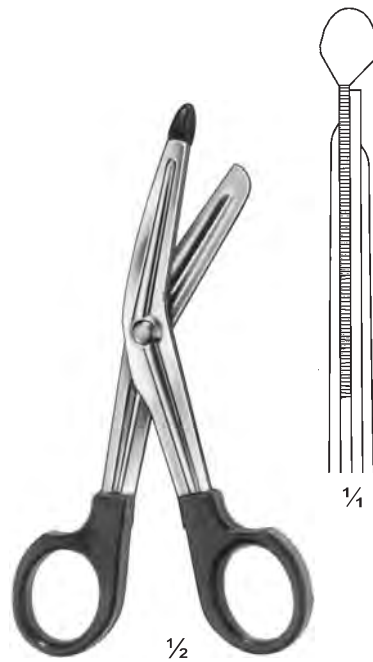

Lister  
107-03-14  
14.5 cm / 5¾"  
Available in different colours

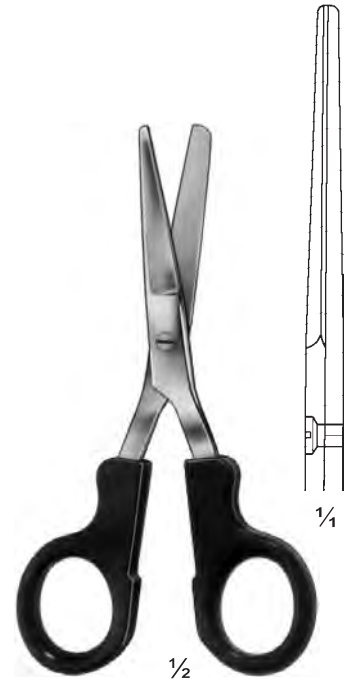

107-04-14  
14.5 cm / 5¾"  
Available in different colours

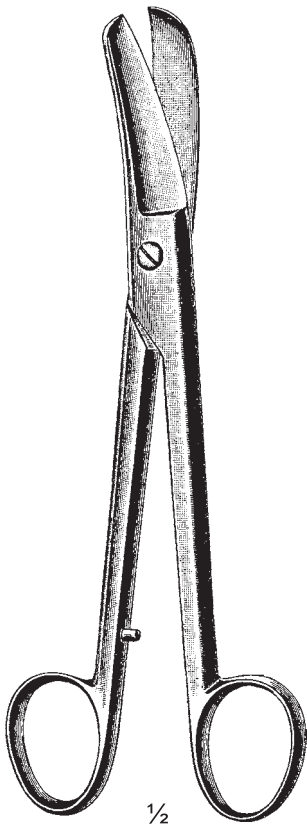

Lorenz  
107-05-23  
23 cm / 9"

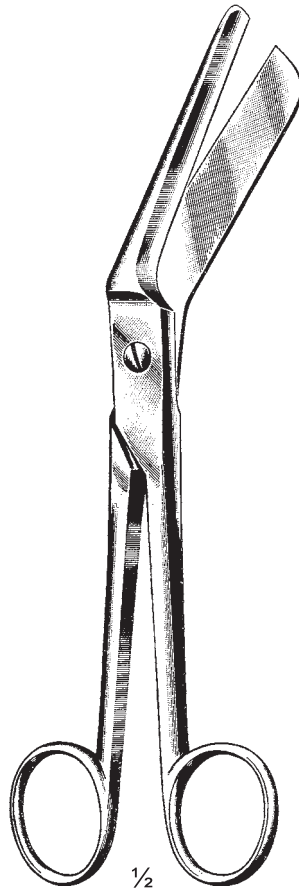

Braun-Stadler  
107-06-23  
23 cm / 9"

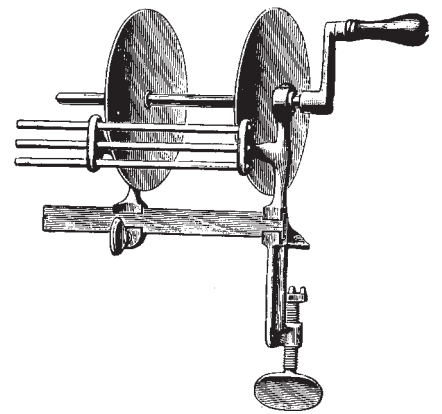

107-07-20  
Adjustable to 20 cm / 8"

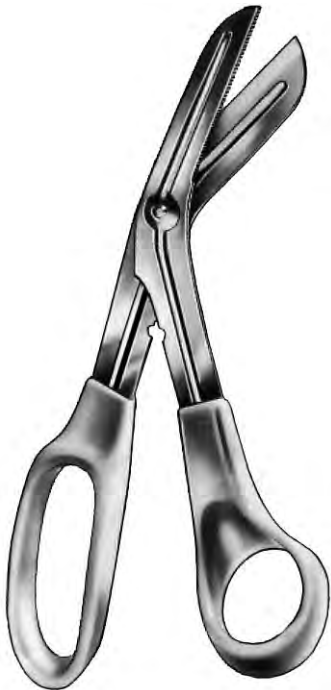

**108-01-20**  
 20 cm / 8"

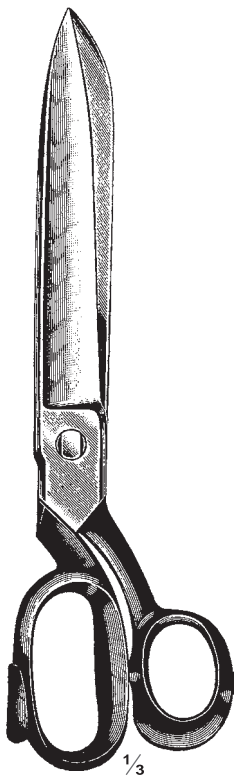

$\frac{1}{3}$   
**108-02-30**  
 30 cm / 12"



Gauze  
**108-03-18** 18 cm / 7"  
**108-04-20** 20 cm / 8"  
**108-05-23** 23 cm / 9"  
**108-06-25** 25 cm / 10"  
**108-07-30** 30 cm / 12"



Taylor  
**108-08-18** 18 cm / 7"  
**108-09-20** 20 cm / 8"  
**108-10-23** 23 cm / 9"  
**108-11-25** 25 cm / 10"  
**108-12-30** 30 cm / 12"

**Verbandscheren  
Bandage Scissors  
Ciseaux pour pansements**



1/4



1/2  
Stille-Mini  
109-01-20  
20 cm / 8"

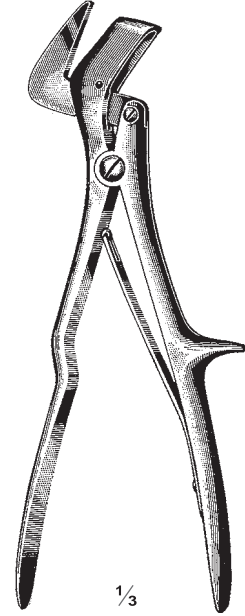

1/3  
Stille  
109-02-24  
24 cm / 9 1/2"



1/3

Stille  
109-03-37 37 cm / 14 1/2"  
109-04-42 42 cm / 16 1/2"

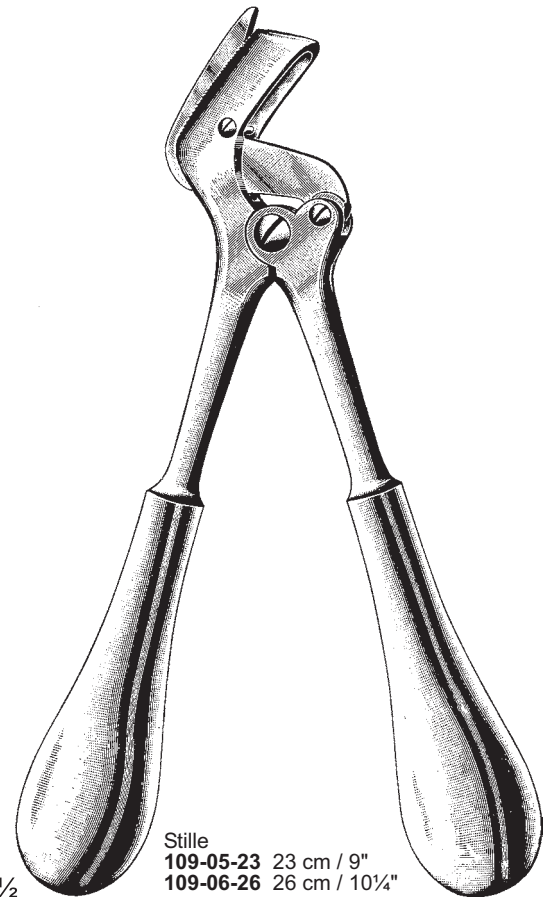

1/2

Stille  
109-05-23 23 cm / 9"  
109-06-26 26 cm / 10 1/4"

**Verbandscheren  
Bandage Scissors  
Ciseaux pour pansements**

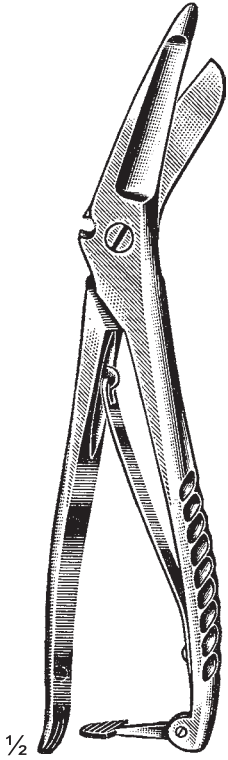

Commander  
110-01-21  
21 cm / 8¼"



Seutin  
110-02-21 21 cm / 8¼"  
110-03-23 23 cm / 9"



Seutin  
110-04-21 21 cm / 8¼"  
110-05-23 23 cm / 9"

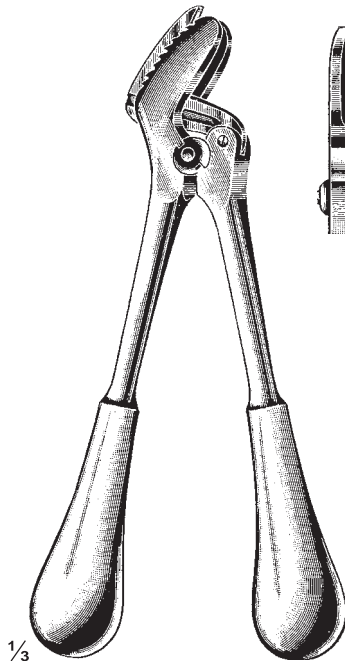

Stille  
110-06-26  
26 cm / 10¼"

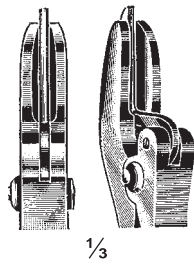

Stille  
110-07-37 37 cm / 14½"  
110-08-42 42 cm / 16½"

**Verbandscheren  
Bandage Scissors  
Ciseaux pour pansements**

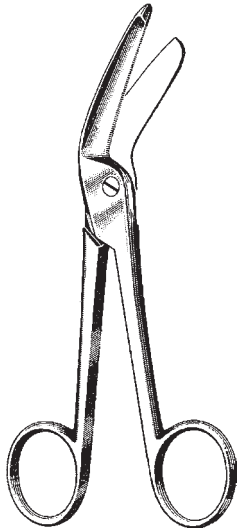

Hercules  
111-01-19  
19 cm / 7½"

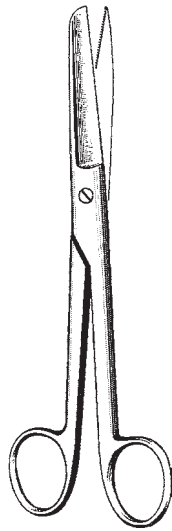

Moleskin  
111-02-19 19 cm / 7½" Str  
111-03-19 19 cm / 7½" Cur

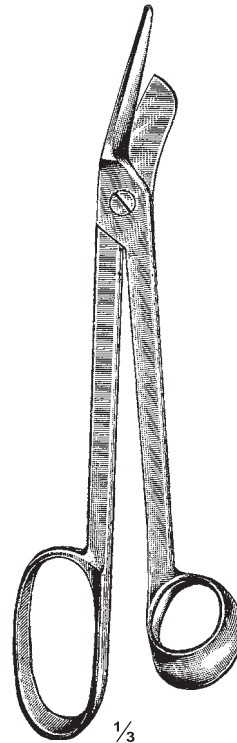

Guy  
111-04-29  
29 cm / 11½"

⅓

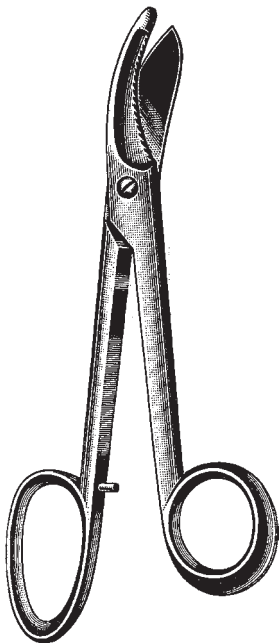

Bruns  
111-05-23  
23.5 cm / 9¼"

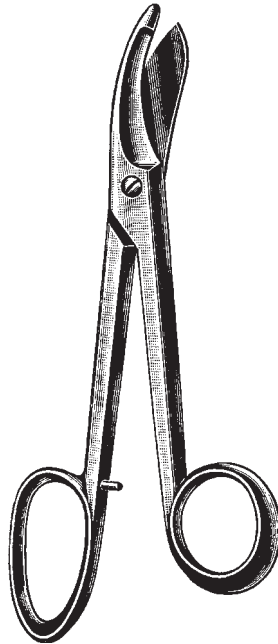

Bruns  
111-06-23  
23.5 cm / 9¼"

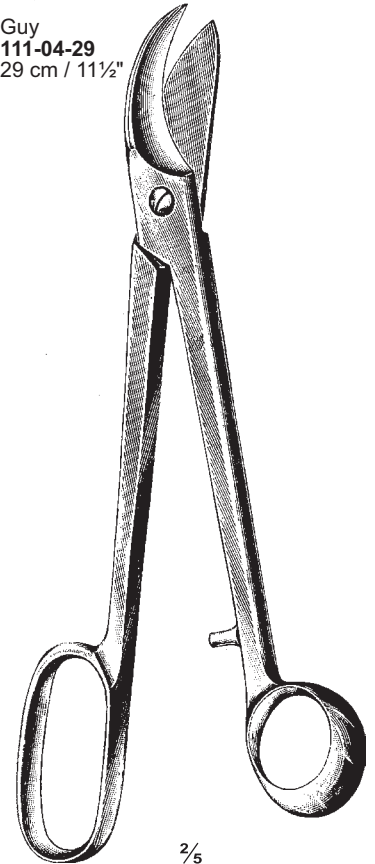

Haglund-  
Stille  
111-07-28  
28 cm / 11"

⅔



## Gipsabreißzangen Plaster Breakers Pincès pour rempre plâtre

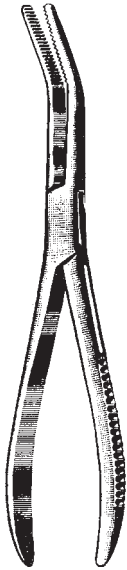

Farabeuf  
112-01-18 18 cm / 7"  
112-02-20 20 cm / 8"  
112-03-24 24 cm / 9½"

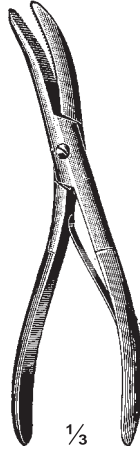

Wolff  
112-04-18  
18 cm / 7"

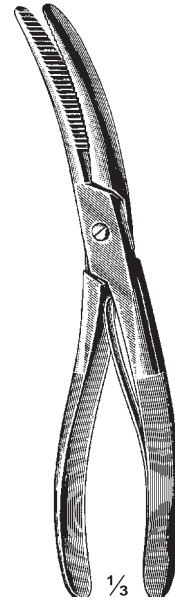

Wolff  
112-05-24  
24 cm / 9½"

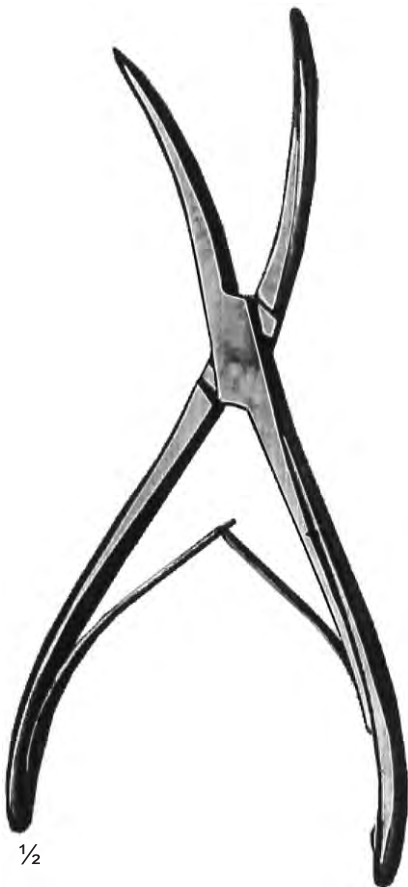

½

Wolff  
112-06-18 18 cm / 7"  
112-07-20 20 cm / 8"  
112-08-22 22 cm / 8¾"  
112-09-24 24 cm / 9½"  
112-10-26 26 cm / 10¼"



½

Mason  
112-11-18 18 cm / 7"  
112-12-20 20 cm / 8"  
112-13-23 23 cm / 9"

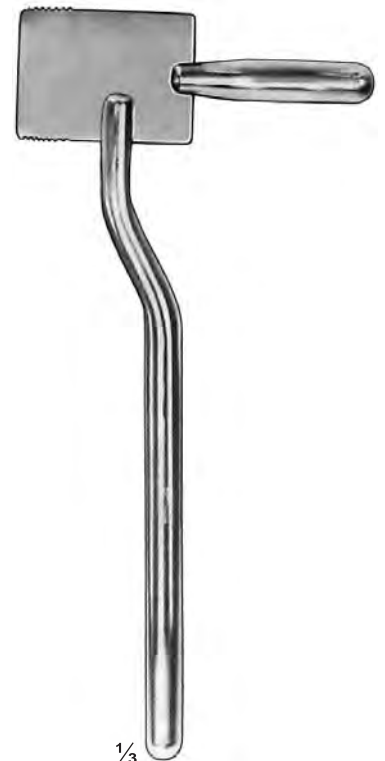

⅓

112-14-30  
30 cm / 12"



**Gipsspreizer  
Plaster Spreaders  
Pinces pour plâtre**

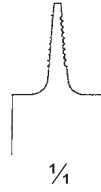
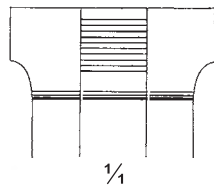
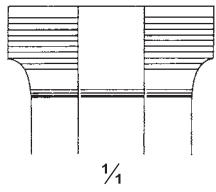

Walton  
113-01-24  
24 cm / 9 1/2"

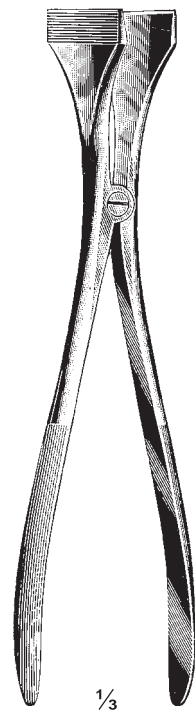

Hennig  
113-02-40 40 mm Jaws  
113-03-60 60 mm Jaws  
28 cm / 11"

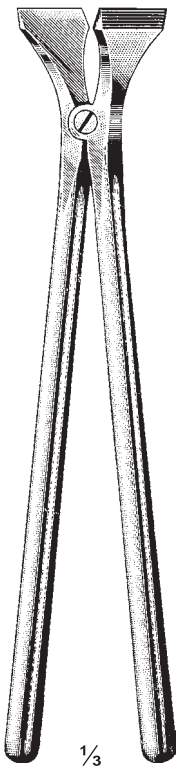

Beeson  
113-04-30  
30 cm / 12"

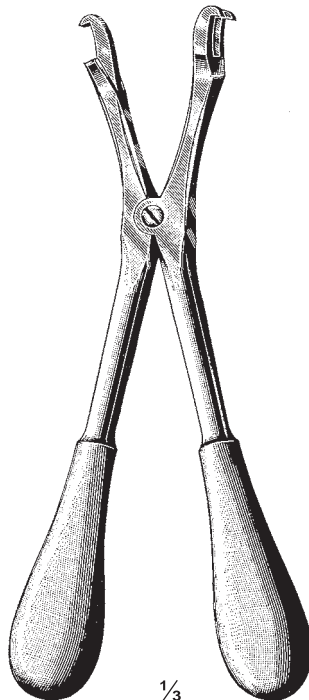

Haglund-Stille  
113-05-28  
28 cm / 11"



Knorr  
113-06-30  
30 cm / 12"



**Gipsmesser  
Plaster Knives  
Couteaux pour plâtre**



$\frac{1}{2}$   
Korte  
**114-01-18**  
18 cm / 7"



$\frac{1}{2}$   
Hopkins  
**114-02-20**  
20 cm / 8"

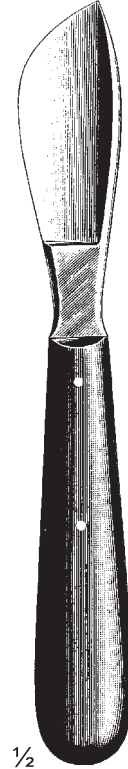

$\frac{1}{2}$   
Hopkins  
**114-03-20**  
20 cm / 8"

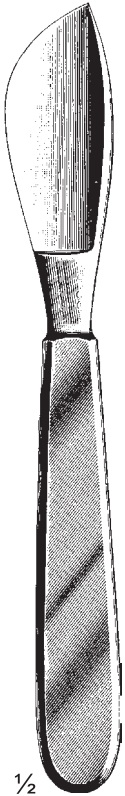

$\frac{1}{2}$   
**114-04-20**  
20 cm / 8"

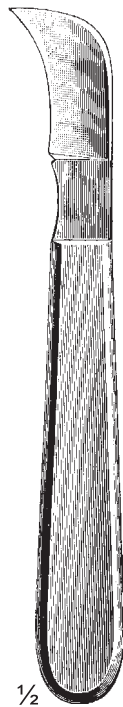

$\frac{1}{2}$   
Reiner  
**114-05-18**  
18.5 cm / 7 $\frac{1}{4}$ "



$\frac{1}{2}$   
Esmarch  
**114-06-18**  
18 cm / 7"



$\frac{1}{2}$   
**114-07-21**  
21 cm / 8 $\frac{1}{4}$ "



$\frac{1}{2}$   
Wigmore  
115-01-19  
19 cm / 7½"

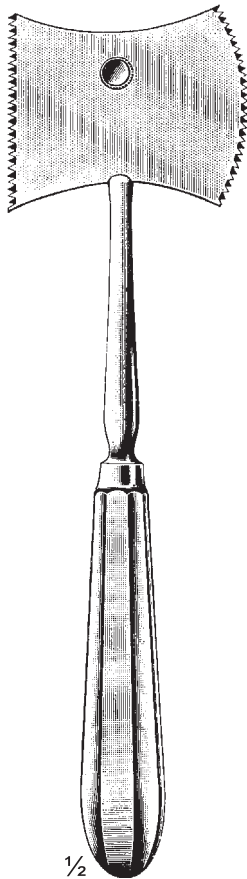

$\frac{1}{2}$   
Kaulich  
115-02-23  
23 cm / 9"

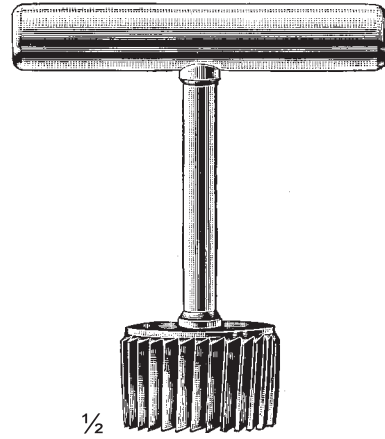

$\frac{1}{2}$   
Galt  
115-03-00

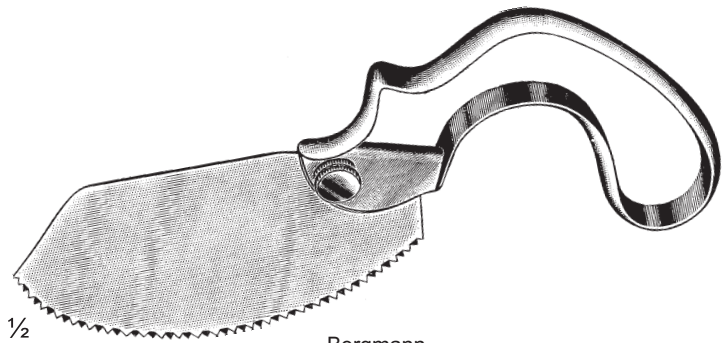

$\frac{1}{2}$   
Bergmann  
115-04-19  
19 cm / 7½"

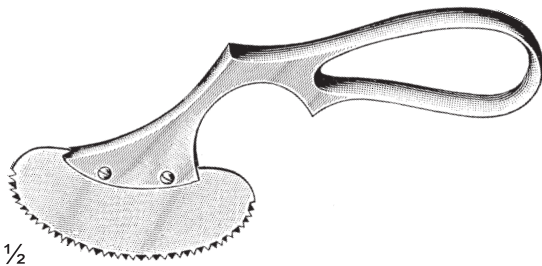

$\frac{1}{2}$   
Engle  
115-05-16  
16 cm / 6¼"

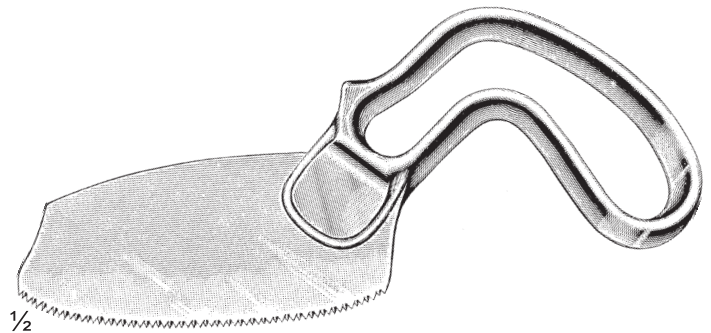

$\frac{1}{2}$   
Bergmann  
115-06-18  
18 cm / 7"

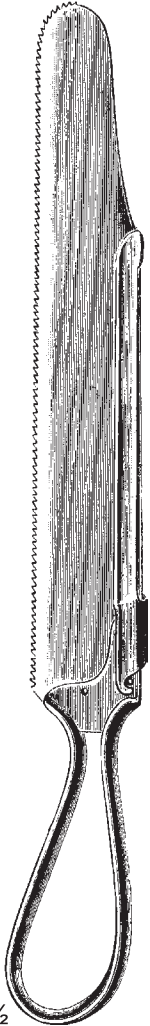

1/2

**Charriere**

	Blade size
116-01-12	12.5 cm / 5"
116-02-18	18 cm / 7"
116-03-21	21 cm / 8 1/4"
116-04-24	24 cm / 9 1/2"
116-05-27	27 cm / 10 1/2"
116-06-30	30 cm / 12"

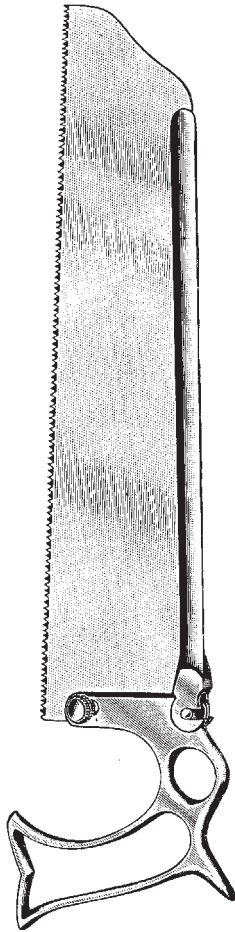

**Weiss**

	Blade size
116-07-20	20 cm / 8"
116-08-23	23 cm / 9"
116-09-25	25 cm / 10"
116-10-30	30 cm / 12"

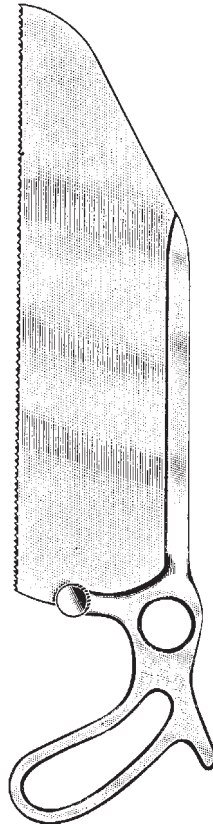

**Satterlee**

	Blade size
116-11-20	20 cm / 8"
116-12-22	22 cm / 8 3/4"
116-13-25	25 cm / 10"
116-14-30	30 cm / 12"



	Blade size
116-15-20	20 cm / 8"
116-16-23	23 cm / 9"
116-17-25	25 cm / 10"
116-18-30	30 cm / 12"

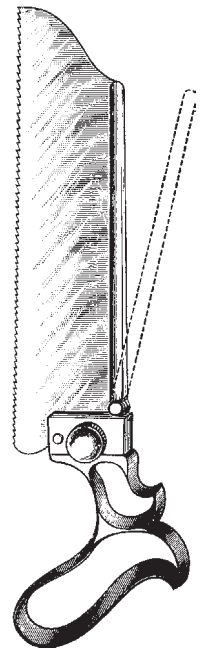

	Blade size
116-19-20	20 cm / 8"
116-20-22	22 cm / 8 3/4"
116-21-25	25 cm / 10"
116-22-30	30 cm / 12"

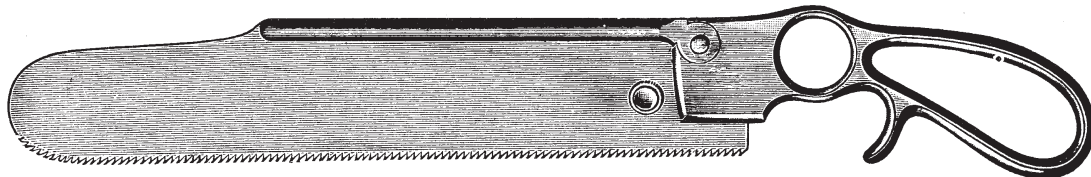

**Detachable**

	Blade size
116-23-12	12.5 cm / 5"
116-24-18	18 cm / 7"
116-25-21	21 cm / 8 1/4"
116-26-24	24 cm / 9 1/2"
116-27-28	28 cm / 11"
116-28-33	33 cm / 13 1/4"

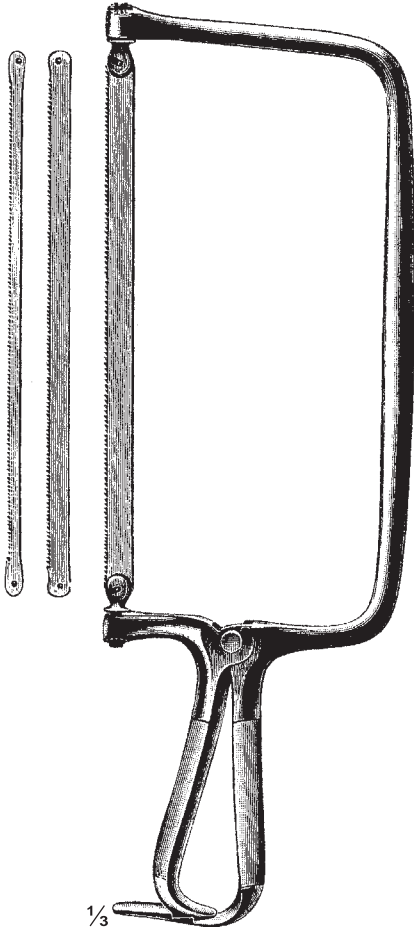

1/3

**Collin**  
**117-01-33** 33 cm / 13 1/4"  
 With 3 blades  
 Blades width 6, 8, 12 mm  
**117-02-35**  
 35 cm / 14"  
 With 4 blades  
 Blades width 4, 5, 8, 12 mm



1/4

**Charriere**  
**117-03-33** 33 cm / 13 1/4"  
**117-04-35** 35 cm / 14"  
**117-05-45** 45 cm / 18"  
 With 2 blades  
 Blades width 12, 15 mm

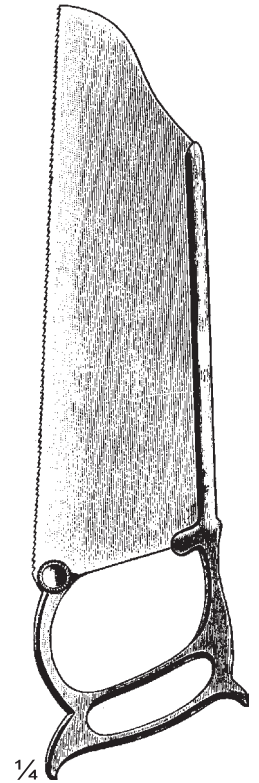

1/4

**Barker**  
 Blade size  
**117-06-20** 20 cm / 8"  
**117-07-22** 22 cm / 8 3/4"  
**117-08-25** 25 cm / 10"  
**117-09-30** 30 cm / 12"

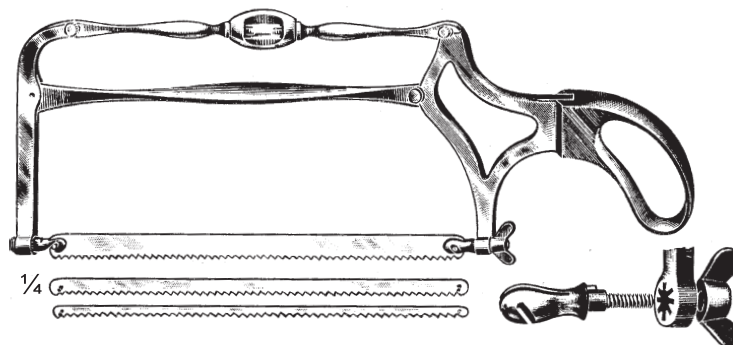

1/4

**Butcher**  
**117-10-37** 37 cm / 14 1/2"  
**117-11-39** 39 cm / 15 1/2"  
 With 3 blades  
 Blades width 8, 10, 12 mm



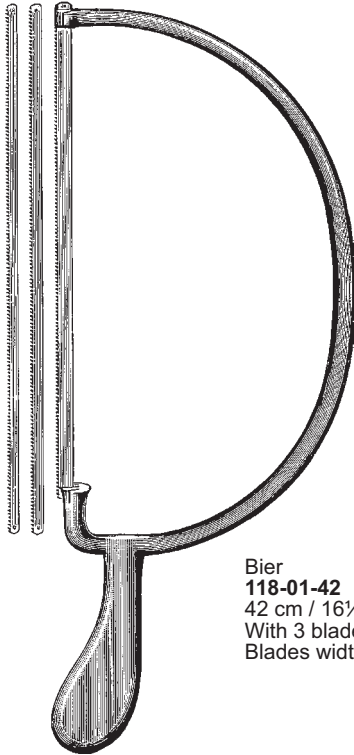

Bier  
**118-01-42**  
42 cm / 16½"  
With 3 blades  
Blades width 3, 5, 7 mm

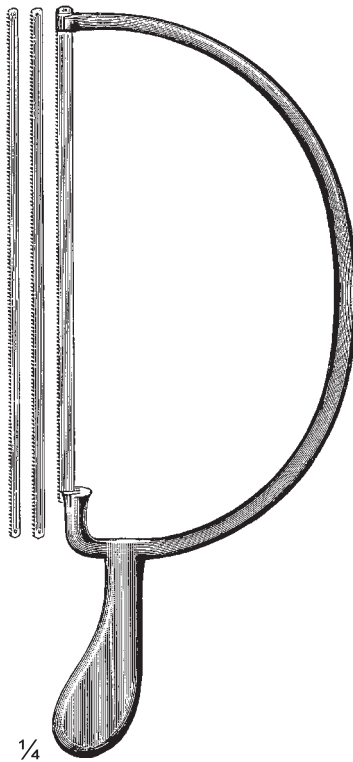

1/4  
Helferich-Bier  
**118-02-39**  
39 cm / 15½"  
With 3 blades  
Blades width 3, 5, 7 mm

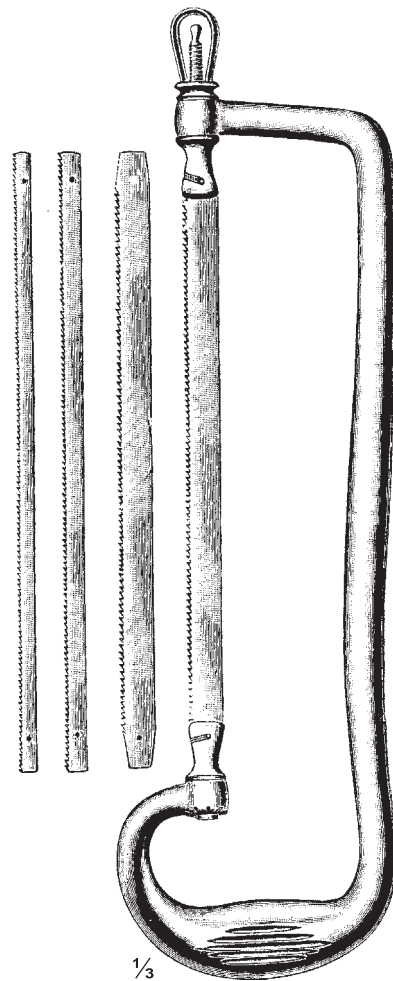

1/3  
Rust  
**118-03-39** 39 cm / 15½"  
**118-04-42** 42 cm / 16¾"  
With 4 blades  
Blades width 4, 6, 12, 15 mm



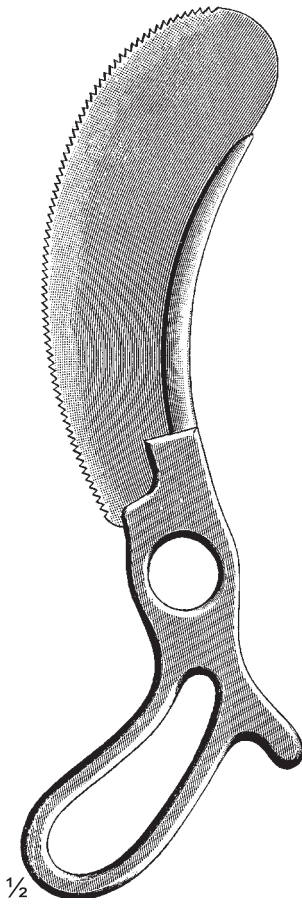

**119-01-24**  
24 cm / 9½"



Langenbeck  
**119-02-23**  
23 cm / 9"



Langenbeck  
**119-03-23**  
23 cm / 9"



Bruns  
**119-04-21**  
21 cm / 8¼"



Lindemann  
**119-05-20**  
20 cm / 8"

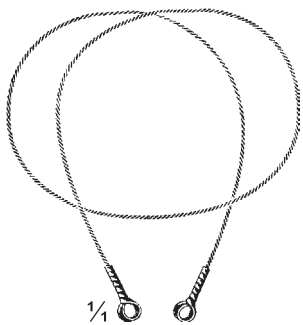

Gigli  
**119-06-30** 30 cm / 12"  
**119-07-40** 40 cm / 15¾"  
**119-08-50** 50 cm / 19¾"

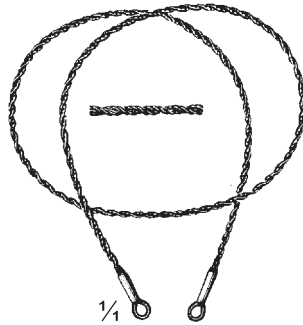

Gigli  
**119-09-30** 30 cm / 12"  
**119-10-40** 40 cm / 15¾"  
**119-11-50** 50 cm / 19¾"

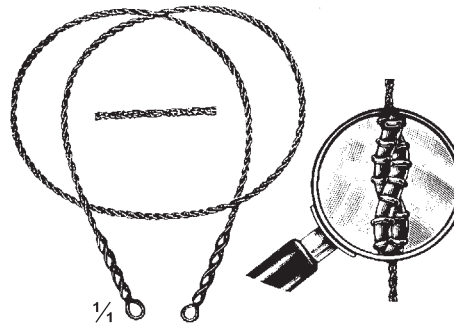

Olivecrona  
**119-12-30** 30 cm / 12"  
**119-13-40** 40 cm / 15¾"  
**119-14-50** 50 cm / 19¾"

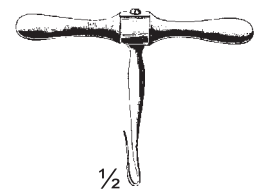

**119-15-05**  
5 cm / 2"  
Hook handle  
for wire saws

# Nagelzangen Nail Nippers Pincès pour couper ongles

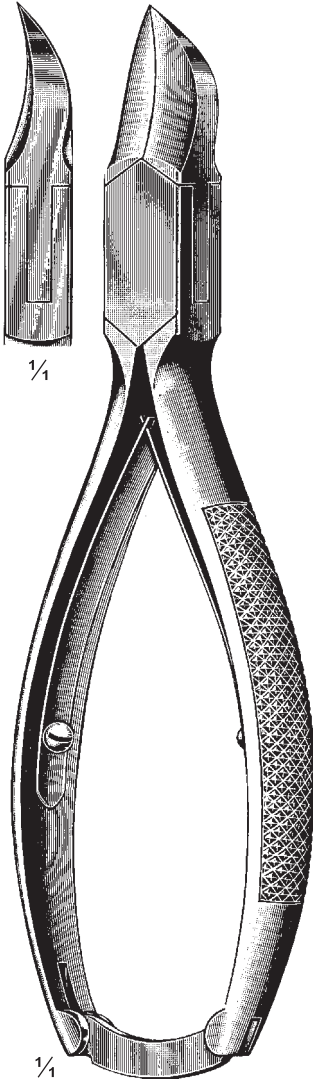

120-01-13 13 cm / 5 1/8"  
120-02-14 14.5 cm / 5 3/4"

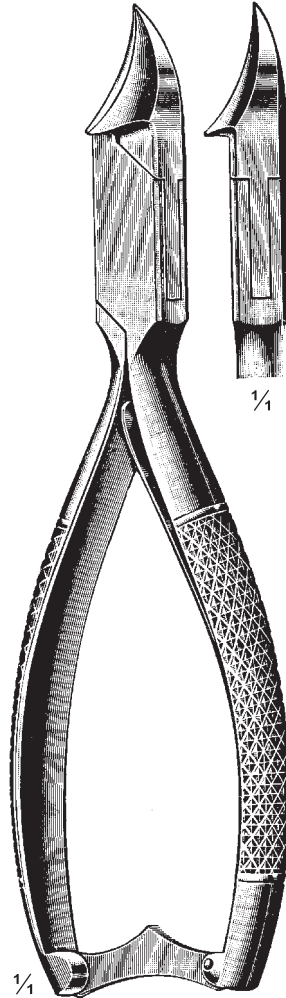

120-03-12 12 cm / 4 3/4"  
120-04-13 13.5 cm / 5 1/4"  
120-05-15 15 cm / 6"

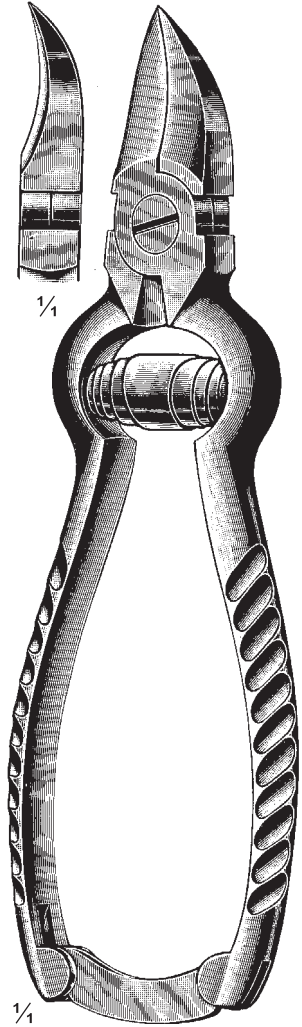

120-06-11 11 cm / 4 1/4"  
120-07-13 13 cm / 5 1/8"  
120-08-14 14 cm / 5 1/2"  
120-09-15 15 cm / 6"

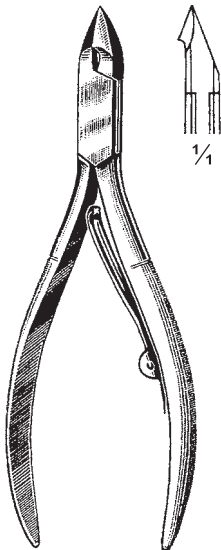

120-10-10  
10 cm / 4"

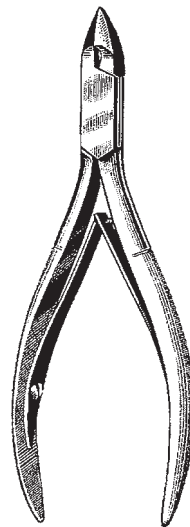

120-11 To 120-13



120-11-10  
10 cm / 4"



120-12-11  
11.5 cm / 4 1/2"



120-13-12  
12.5 cm / 5"

**Nagelzangen  
Nail Nippers  
Pincès pour couper ongles**

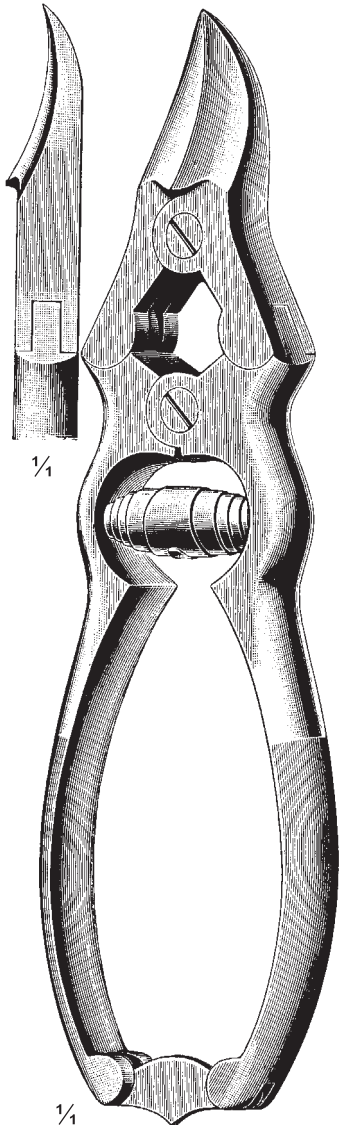

**121-01-15**  
15 cm / 6"



**121-02-12** 12 cm / 4<sup>3</sup>/<sub>4</sub>"  
**121-03-13** 13 cm / 5<sup>1</sup>/<sub>8</sub>"  
**121-04-15** 15 cm / 6"



**121-05-12** 12 cm / 4<sup>3</sup>/<sub>4</sub>"  
**121-06-13** 13 cm / 5<sup>1</sup>/<sub>8</sub>"  
**121-07-15** 15 cm / 6"

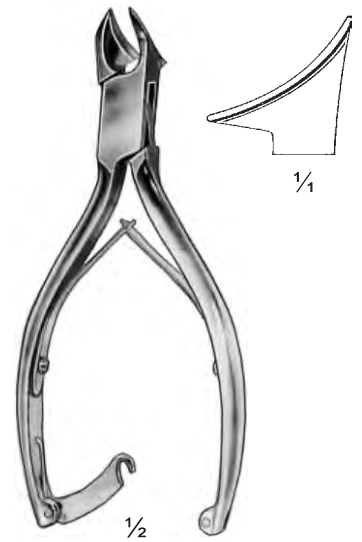

**121-08-14**  
14 cm / 5<sup>1</sup>/<sub>2</sub>"

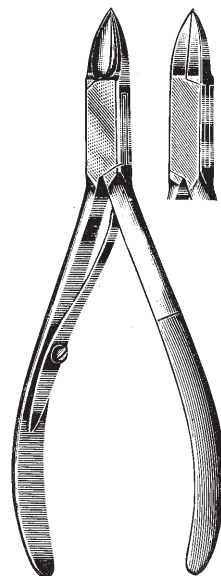

**121-09-11** 11.5 cm / 4<sup>1</sup>/<sub>2</sub>"  
**121-10-13** 13 cm / 5<sup>1</sup>/<sub>8</sub>"



**121-11-14**  
14 cm / 5<sup>1</sup>/<sub>2</sub>"

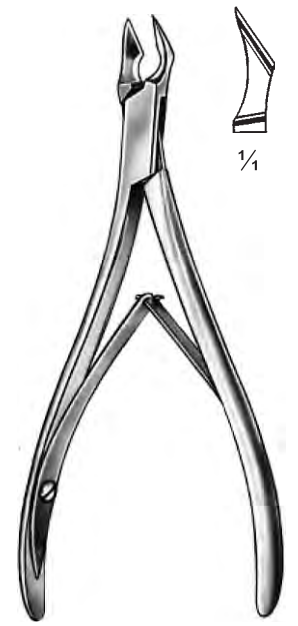

Illic  
**121-12-13**  
13 cm / 5<sup>1</sup>/<sub>8</sub>"

**Nagelhautzangen**  
**Cuticle Nippers**  
**Pincès à envies**

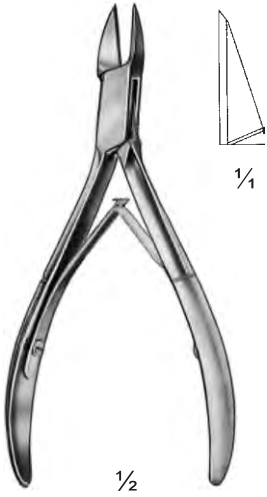

**122-01-13** 13 cm / 5 $\frac{1}{8}$ "  
**122-02-15** 15 cm / 6"

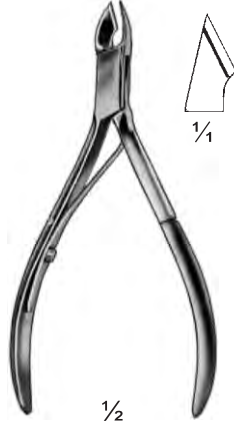

**122-03-11**  
 11.5 cm / 4 $\frac{1}{2}$ "



**122-04-11** 11 cm / 4 $\frac{1}{4}$ "  
**122-05-13** 13 cm / 5 $\frac{1}{8}$ "

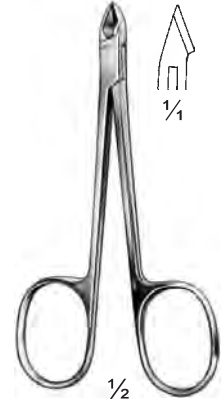

**122-06-10**  
 10.5 cm / 4 $\frac{1}{8}$ "

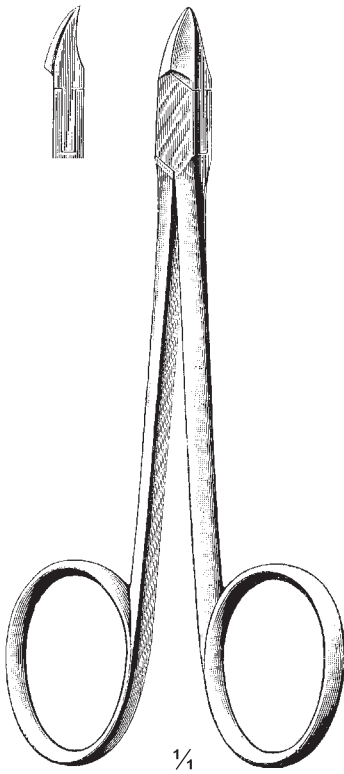

**122-07-10** 10 cm / 4"  
**122-08-13** 13 cm / 5 $\frac{1}{8}$ "



Cohen  
**122-09-13**  
 13 cm / 5 $\frac{1}{8}$ "



Cohen  
**122-10-13**  
 13 cm / 5 $\frac{1}{8}$ "



123-02-13



123-03-13



123-04-13



123-05-13

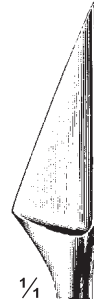

123-06-13



123-07-13



123-08-13

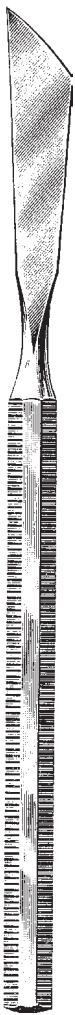

123-01-13  
123-01-13 To 123-18-13  
13.5 cm / 5¼"

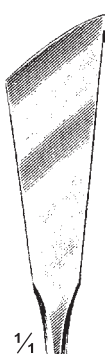

123-09-13

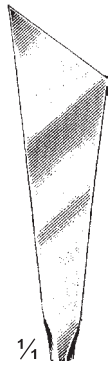

123-10-13



123-11-13



123-12-13



123-13-13



123-14-13



123-15-13

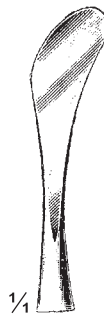

123-16-13



123-17-13

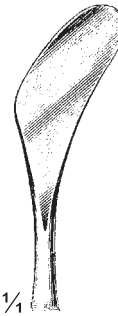

123-18-13



123-19-11  
11 cm / 4¼"

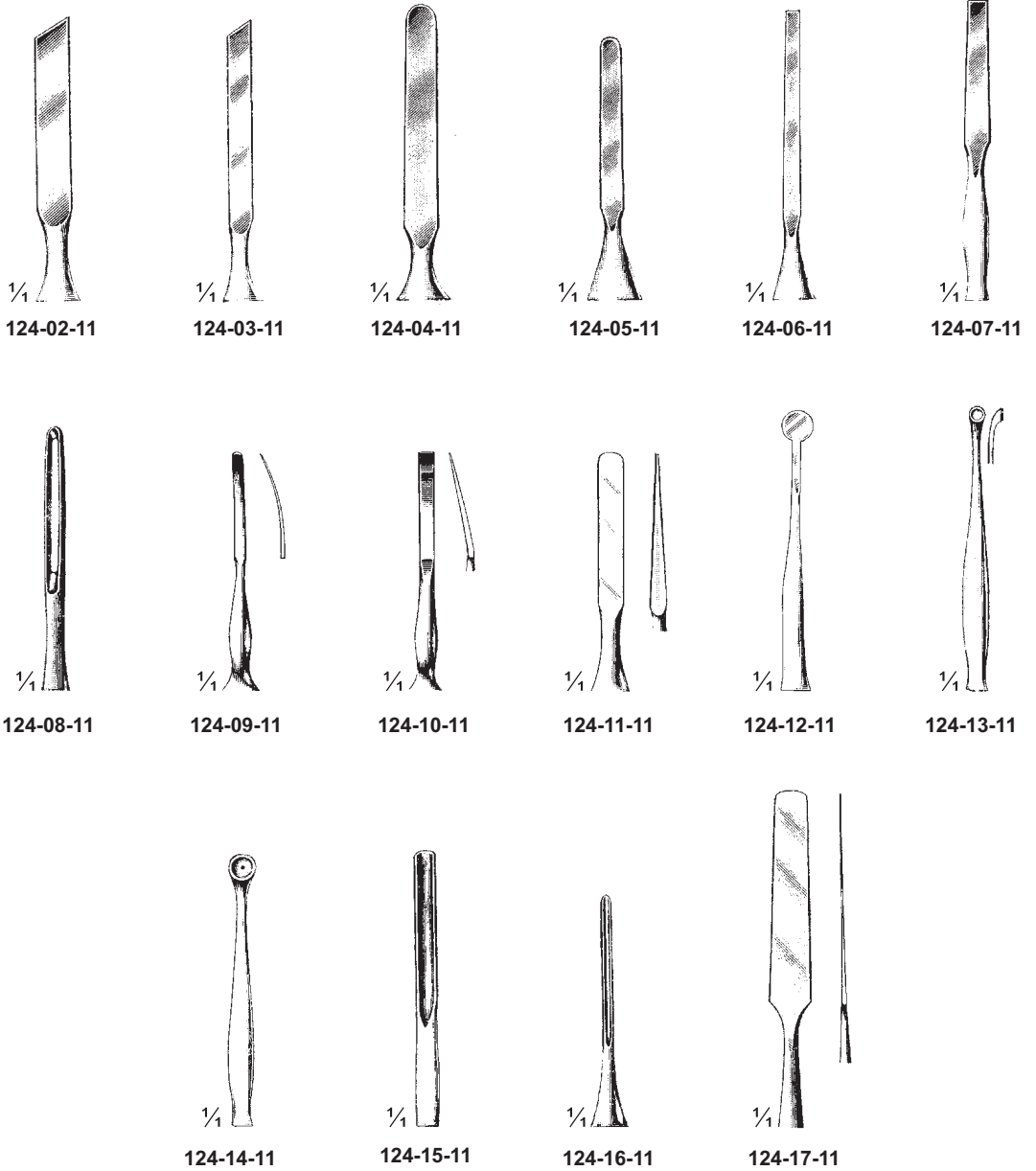

1/4

124-01-11  
124-01-11 To 124-17-11  
11.5 cm / 4 1/2"



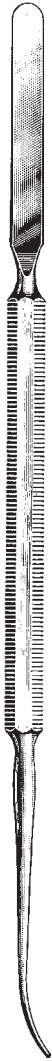

125-01-14  
14.5 cm / 5¾"

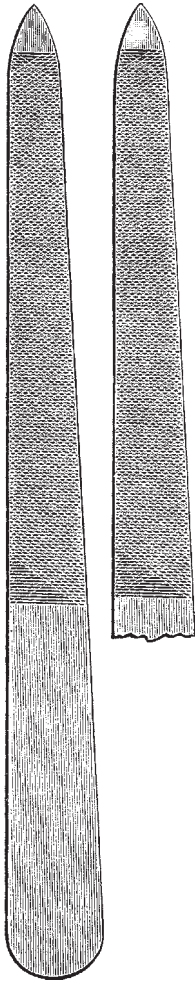

125-06-13  
13 cm / 5½"



¼  
125-02-14  
14.5 cm / 5¾"

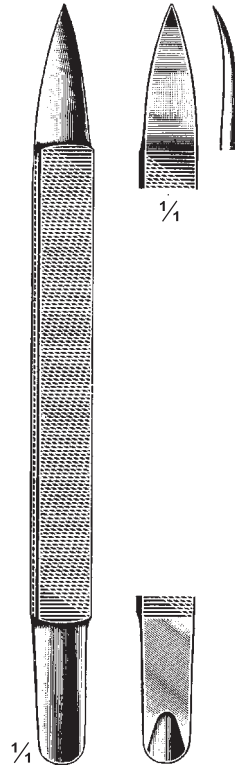

¼  
125-07-10 10 cm / 4"  
125-08-11 11.5 cm / 4½"



¼  
125-03-13  
13 cm / 5½"



¼  
125-04-13  
13 cm / 5½"



½  
125-09-16  
16 cm / 6¼"



¼  
125-05-14  
14.5 cm / 5¾"

# Nagelscheren Nail Scissors Ciseaux à ongles

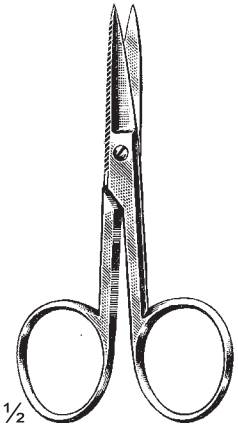

**126-01-09** 9 cm / 3½"  
**126-02-10** 10.5 cm / 4¼"

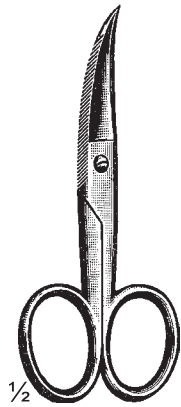

**126-03-09** 9 cm / 3½"  
**126-04-10** 10.5 cm / 4¼"

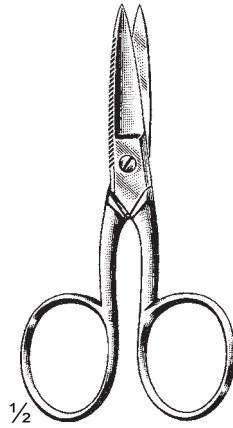

**126-05-09** 9 cm / 3½"  
**126-06-10** 10.5 cm / 4¼"

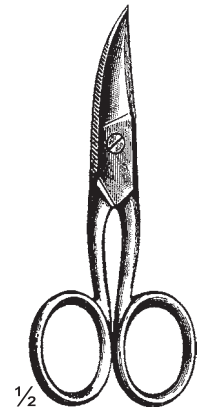

**126-07-09** 9 cm / 3½"  
**126-08-10** 10.5 cm / 4¼"



**126-09-09 To 126-12-10**

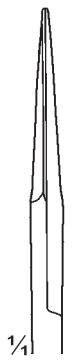

**126-09-09**  
9 cm / 3½"



**126-10-09**  
9 cm / 3½"



**126-11-10**  
10 cm / 4"



**126-12-10**  
10 cm / 4"



**126-13-09 To 126-15-10**



**126-13-09**  
9.5 cm / 3¾"



**126-14-09**  
9.5 cm / 3¾"



**126-15-10**  
10.5 cm / 4¼"

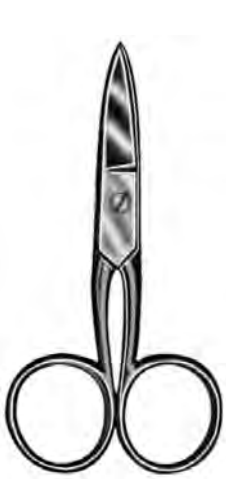

**127-01-09** 9 cm / 3½"  
**127-02-10** 10 cm / 4"

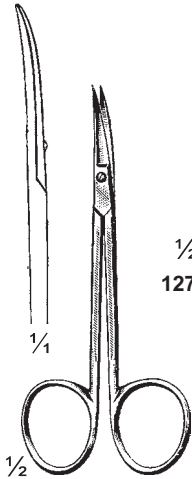

**127-03-09** 9 cm / 3½" Str  
**127-04-10** 10 cm / 4" Str  
**127-05-09** 9 cm / 3½" Cur  
**127-06-10** 10 cm / 4" Cur

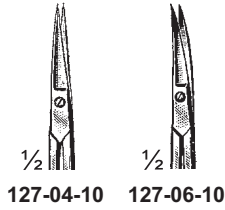

**127-07-09** 9 cm / 3½" Str  
**127-08-10** 10 cm / 4" Str  
**127-09-09** 9 cm / 3½" Cur  
**127-10-10** 10 cm / 4" Cur



**127-11-09** 9 cm / 3½" Str  
**127-12-10** 10 cm / 4" Str  
**127-13-09** 9 cm / 3½" Cur  
**127-14-10** 10 cm / 4" Cur



**127-15-09** 9 cm / 3½" Str  
**127-16-10** 10 cm / 4" Str  
**127-17-09** 9 cm / 3½" Cur  
**127-18-10** 10 cm / 4" Cur



**127-19-09** 9 cm / 3½" Str  
**127-20-10** 10 cm / 4" Str  
**127-21-09** 9 cm / 3½" Cur  
**127-22-10** 10 cm / 4" Cur



**127-23-09** 9 cm / 3½" Str  
**127-24-10** 10 cm / 4" Str  
**127-25-09** 9 cm / 3½" Cur  
**127-26-10** 10 cm / 4" Cur

# Nagelscheren Nail Scissors Ciseaux à ongles



1/2

Standard  
128-01-10 To 128-09-30  
Broad points



1/4

128-01-10  
10 cm / 4"



1/4

128-02-12  
12 cm / 4 3/4"



1/4

128-03-12  
12.5 cm / 5"



1/4

128-04-14  
14 cm / 5 1/2"



1/4

128-05-16  
16 cm / 6 1/4"



1/4

128-06-18  
18 cm / 7"



1/4

128-07-20  
20 cm / 8"



1/4

128-08-25  
25 cm / 10"



1/4

128-09-30  
30 cm / 12"



1/2

128-10-12 To 128-12-16  
3 X 4 Teeth



1/4

128-10-12  
12.5 cm / 5"

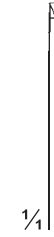

1/4

128-11-14  
14 cm / 5 1/2"



1/4

128-12-16  
16 cm / 6 1/4"



1/2

128-13-10 To 128-21-30  
1 X 2 Teeth



1/4

128-13-10  
10 cm / 4"



1/4

128-14-12  
12 cm / 4 3/4"



1/4

128-15-12  
12.5 cm / 5"



1/4

128-16-14  
14 cm / 5 1/2"



1/4

128-17-16  
16 cm / 6 1/4"



1/4

128-18-18  
18 cm / 7"



1/4

128-19-20  
20 cm / 8"



1/4

128-20-25  
25 cm / 10"



1/4

128-21-30  
30 cm / 12"



1/2

128-22-12 To 128-24-16  
4 X 5 Teeth



1/4

128-22-12  
12.5 cm / 5"



1/4

128-23-14  
14 cm / 5 1/2"



1/4

128-24-16  
16 cm / 6 1/4"

# Anatomische Pinzettent, Chirurgische Pinzetten Dressing & Tissue Forceps Pincés à dissection, Pincés à dissection à griffes



Standard  
129-01-10 To 129-08-30  
Narrow points

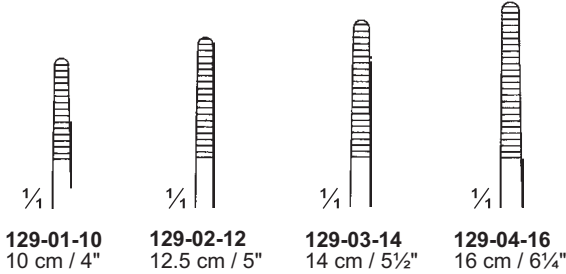

129-01-10 10 cm / 4"  
129-02-12 12.5 cm / 5"  
129-03-14 14 cm / 5½"  
129-04-16 16 cm / 6¼"

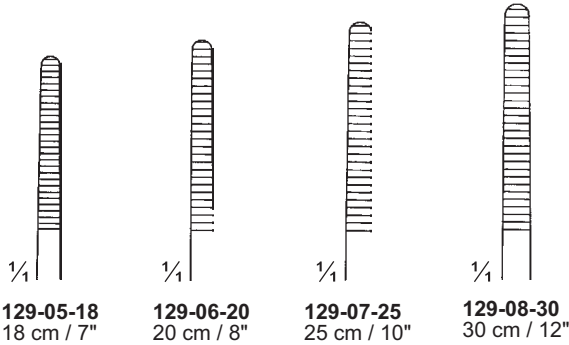

129-05-18 18 cm / 7"  
129-06-20 20 cm / 8"  
129-07-25 25 cm / 10"  
129-08-30 30 cm / 12"

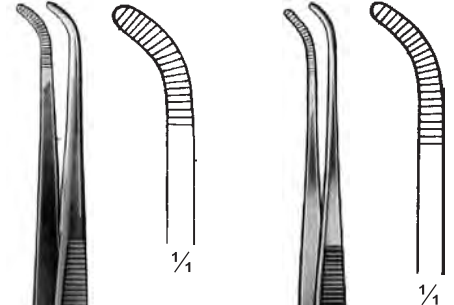

129-09-10 10 cm / 4"  
129-18-10 10 cm / 4"

129-10-11 11.5 cm / 4½"  
129-11-12 12.5 cm / 5"  
129-12-14 14 cm / 5½"  
129-13-16 16 cm / 6¼"  
129-14-18 18 cm / 7"  
129-15-20 20 cm / 8"  
129-16-25 25 cm / 10"  
129-17-30 30 cm / 12"  
129-19-11 11.5 cm / 4½"  
129-20-12 12.5 cm / 5"  
129-21-14 14 cm / 5½"  
129-22-16 16 cm / 6¼"  
129-23-18 18 cm / 7"  
129-24-20 20 cm / 8"  
129-25-25 25 cm / 10"  
129-26-30 30 cm / 12"



129-27-11 To 129-33-25  
2 X 3 Teeth

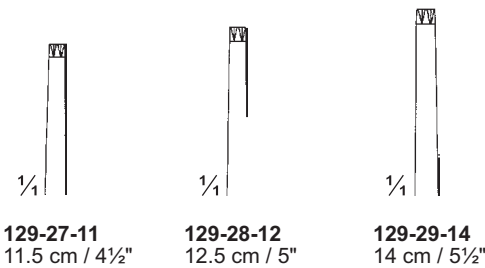

129-27-11 11.5 cm / 4½"  
129-28-12 12.5 cm / 5"  
129-29-14 14 cm / 5½"

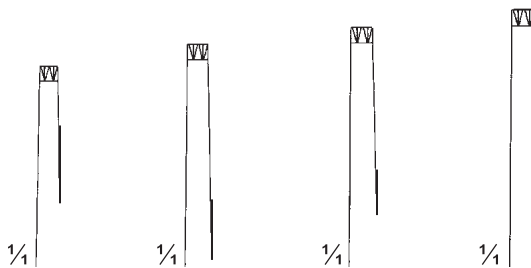

129-30-16 16 cm / 6¼"  
129-31-18 18 cm / 7"  
129-32-20 20 cm / 8"  
129-33-25 25 cm / 10"

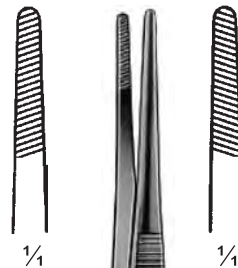

129-34-12 12.5 cm / 5"  
129-35-14 14 cm / 5½"  
129-36-16 16 cm / 6¼"

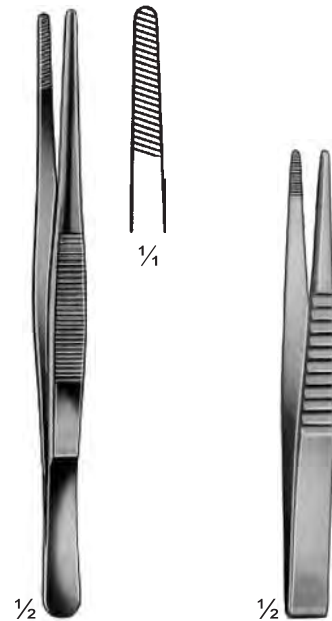

129-37-12 12.5 cm / 5"  
129-38-15 15.5 cm / 6½"

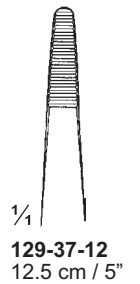

129-37-12 12.5 cm / 5"

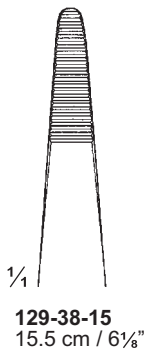

129-38-15 15.5 cm / 6½"

# Anatomische Pinzettent, Chirurgische Pinzetten Dressing & Tissue Forceps Pincès à dissection, Pincès à dissection à griffes



Standard  
130-01-11 To 130-08-30  
Narrow points

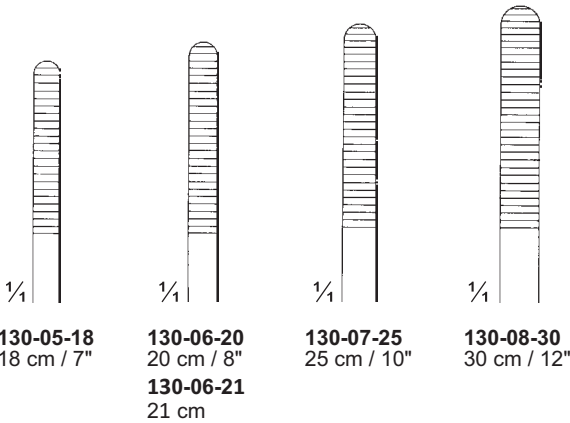
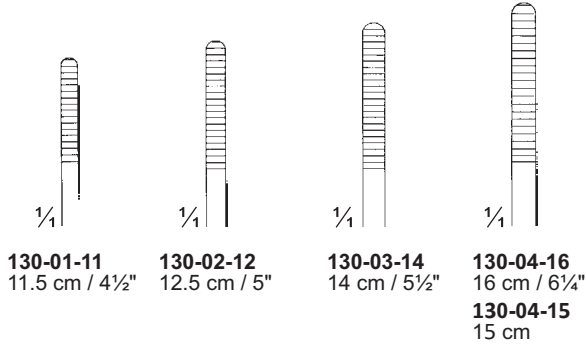

Turnover end  
130-09-12 12.5 cm / 5"  
130-10-15 15 cm / 6"  
130-11-18 18 cm / 7"  
130-12-20 20 cm / 8"  
130-13-23 23 cm / 9"  
130-14-25 25 cm / 10"  
130-15-28 28 cm / 11"  
130-16-30 30 cm / 12"

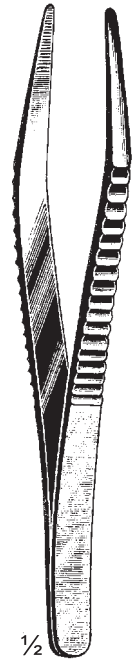

Fluted rivetted  
130-17-12 12.5 cm / 5"  
130-18-15 15 cm / 6"  
130-19-18 18 cm / 7"  
130-20-20 20 cm / 8"  
130-21-23 23 cm / 9"  
130-22-25 25 cm / 10"  
130-23-28 28 cm / 11"  
130-24-30 30 cm / 12"





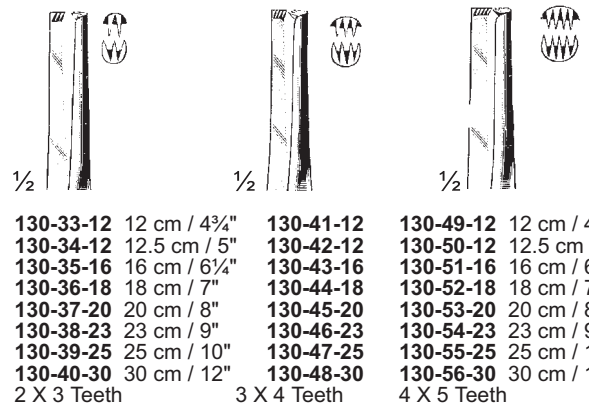
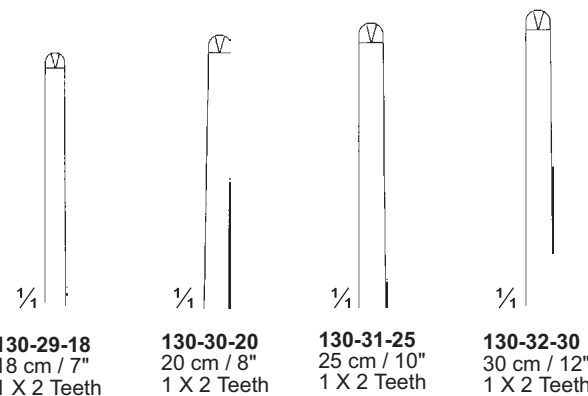
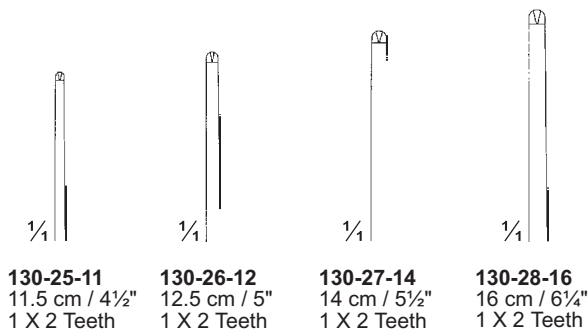









130-25-11 To 130-56-30  
1 X 2 Teeth





# Anatomische Pinzettent, Chirurgische Pinzetten Dressing & Tissue Forceps Pincès à dissection, Pincès à dissection à griffes

 <p><b>131-01-12</b> 12.5 cm / 5"</p>	 <p><b>131-02-14</b> 14 cm / 5½"</p>	 <p><b>131-04-11</b> 11 cm / 4¼" <b>131-05-12</b> 12.5 cm / 5"</p>	 <p><b>131-06-15</b> 15 cm / 6" <b>131-07-18</b> 18 cm / 7" <b>131-08-20</b> 20 cm / 8"</p>	 <p><b>131-09-11</b> 11 cm / 4¼" <b>131-10-12</b> 12.5 cm / 5" 1 X 2 Teeth</p>	 <p><b>131-11-15</b> 15 cm / 6" <b>131-12-18</b> 18 cm / 7" <b>131-13-20</b> 20 cm / 8" 1 X 2 Teeth</p>
 <p><b>131-01-12 To 131-03-16</b> <b>131-03-16</b> 16 cm / 6¼"</p>	 <p><b>131-14-18</b> 1 X 2 Teeth <b>131-15-18</b> 2 X 3 Teeth</p>	 <p><b>131-16-18</b> 1 X 2 Teeth <b>131-17-18</b> 2 X 3 Teeth</p>	 <p><b>131-18-18</b> 1 X 2 Teeth <b>131-19-18</b> 2 X 3 Teeth</p>	 <p><b>131-20-13</b> 13 cm / 5½" <b>131-21-15</b> 15 cm / 6"</p>	 <p><b>131-22-17</b> 17 cm / 6¾" <b>131-23-20</b> 20 cm / 8"</p>
<p>Ferris-Smith <b>131-14-18 &amp; 131-15-18</b> 18 cm / 7"</p>	<p>Ferris-Smith <b>131-16-18 &amp; 131-17-18</b> 18 cm / 7"</p>	<p>Boney <b>131-18-18 &amp; 131-19-18</b> 18 cm / 7"</p>	<p><b>131-20-13 To 131-23-20</b> Swedish pattern</p>		

# Anatomische Pinzettent, Chirurgische Pinzetten Dressing & Tissue Forceps Pincès à dissection, Pincès à dissection à griffes

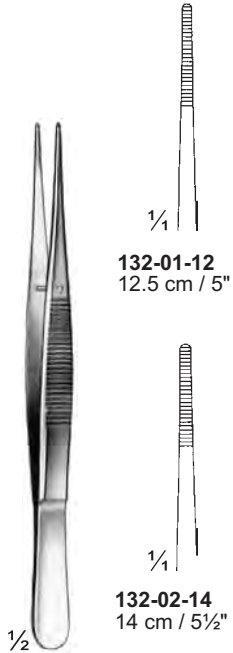

132-01-12 & 132-02-14

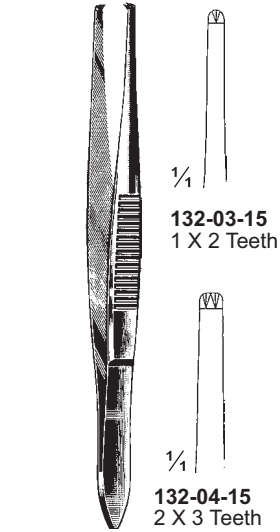

Stille  
132-03-15 & 132-04-15  
15 cm / 6"

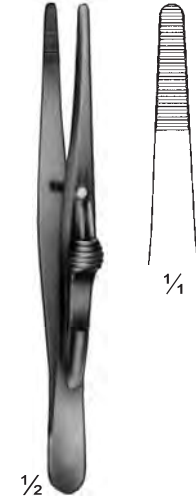

Fricke  
132-05-13  
13 cm / 5 1/8"

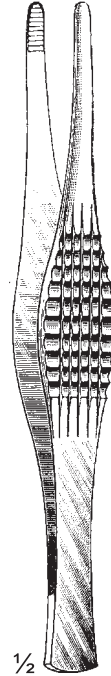

Ramsay  
132-06-18  
18 cm / 7"

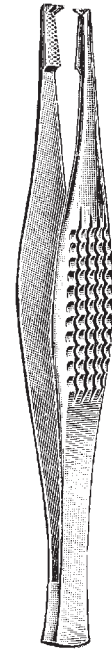

Ramsay  
132-07-18  
18 cm / 7"  
1 X 2 Teeth

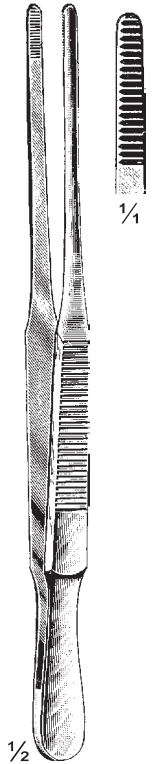

Duehrssen  
132-08-20  
20 cm / 8"

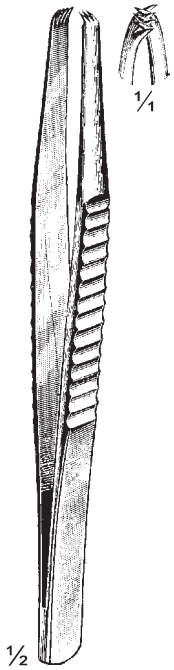

Rooke  
132-09-12 12.5 cm / 5"  
132-10-15 15 cm / 6"  
132-11-18 18 cm / 7"  
132-12-20 20 cm / 8"  
3 X 4 Teeth

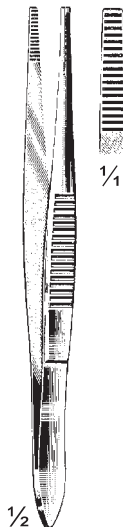

Stille  
132-13-12 12.5 cm / 5"  
132-14-14 14 cm / 5 1/2"  
132-15-15 15 cm / 6"  
132-16-18 18 cm / 7"  
132-17-20 20 cm / 8"



McIndoe  
132-18-16  
16 cm / 6 1/4"

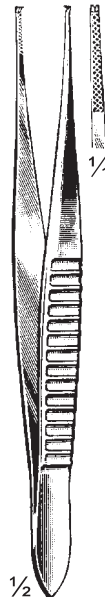

Gillies  
132-19-16  
16 cm / 6 1/4"  
1 X 2 Teeth

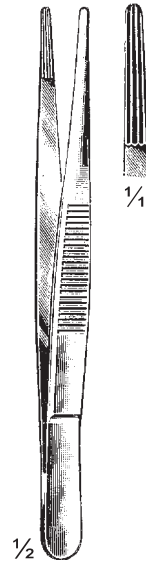

Ochsner  
132-20-14 14 cm / 5 1/2"  
132-21-16 16 cm / 6 1/4"

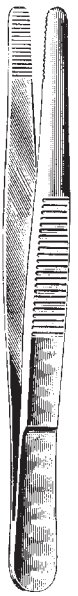

Strong Model  
132-22-14  
14 cm / 5 1/2"

# Anatomische Pinzettent, Chirurgische Pinzetten Dressing & Tissue Forceps Pincés à dissection, Pincés à dissection à griffes

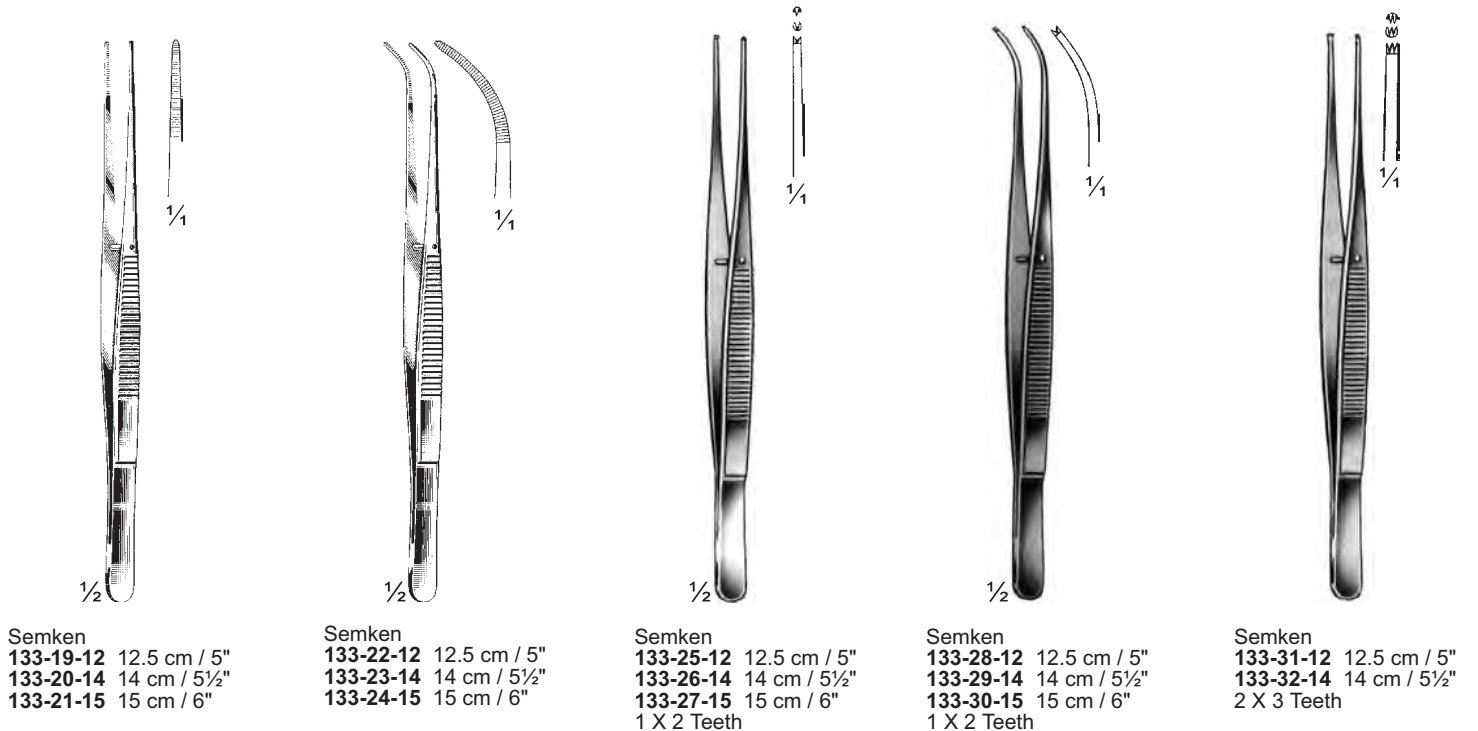
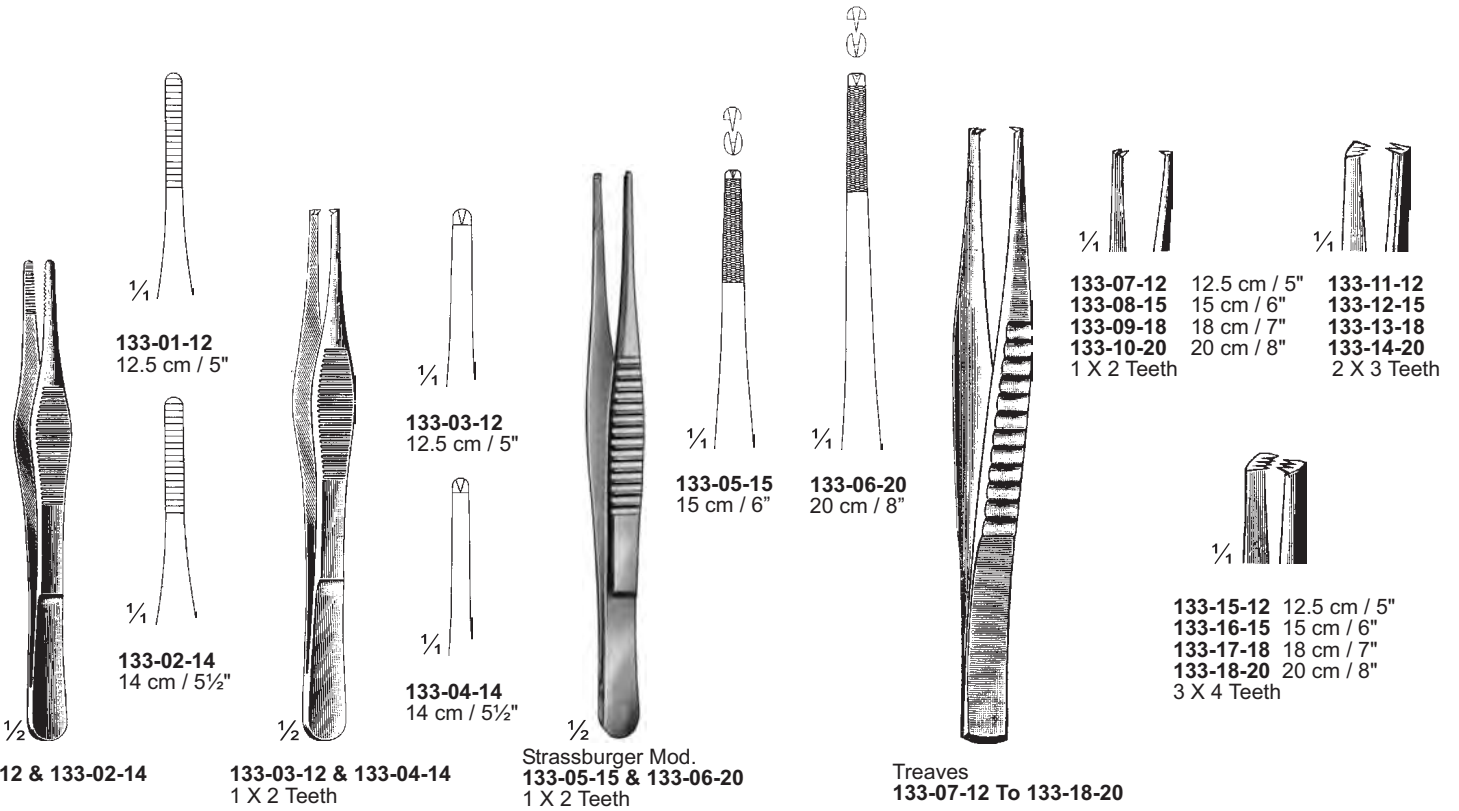

# Anatomische Pinzettent, Chirurgische Pinzetten Dressing & Tissue Forceps Pincés à dissection, Pincés à dissection à griffes

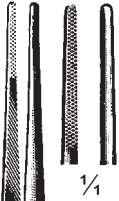

1/2

Waugh  
134-01-18 18 cm / 7"  
134-02-20 20 cm / 8"  
134-03-25 25 cm / 10"  
134-04-30 30 cm / 12"



1/2

Waugh  
134-05-18 18 cm / 7"  
134-06-20 20 cm / 8"  
134-07-25 25 cm / 10"  
134-08-30 30 cm / 12"  
1 X 2 Teeth



1/2

Waugh  
134-09-18 To 134-12-30  
1 X 2 Teeth

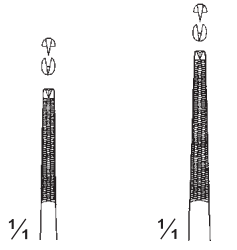

1/4

134-09-18  
18 cm / 7"



1/4

134-10-20  
20 cm / 8"



1/4

134-11-25  
25 cm / 10"



1/4

134-12-30  
30 cm / 12"



1/2

Stille-Barraya  
134-13-18 To 134-15-25  
3 X 4 Teeth



1/4

134-13-18  
18 cm / 7"



1/4

134-14-20  
20 cm / 8"

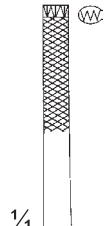

1/4

134-15-25  
25 cm / 10"

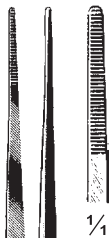

1/4

1/2

Brophy  
134-16-20  
20 cm / 8"

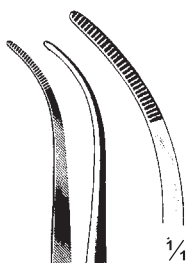

1/4

1/2

Brophy  
134-17-20  
20 cm / 8"



1/4

1/2

Brophy  
134-18-20  
20 cm / 8"  
1 X 2 Teeth

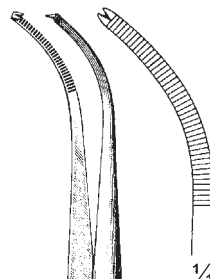

1/4

1/2

Brophy  
134-19-20  
20 cm / 8"  
1 X 2 Teeth

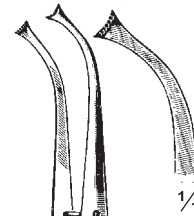

1/4

Koenig  
134-20-16  
16 cm / 6 1/4"  
9 X 10 Teeth

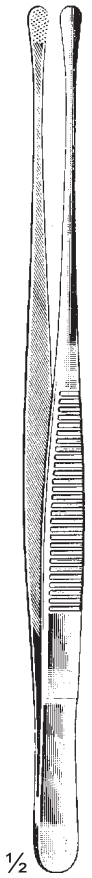

1/2

Wangensteen  
134-21-23  
23 cm / 9"

# Anatomische Pinzettent, Chirurgische Pinzetten Dressing & Tissue Forceps Pincés à dissection, Pincés à dissection à griffes

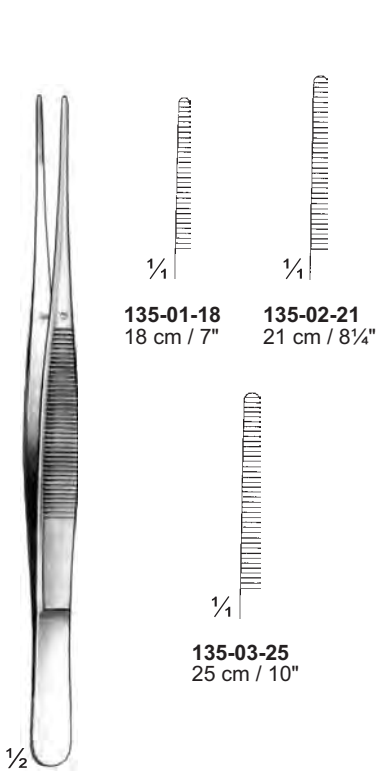

Potts-Smith  
135-01-18 To 135-03-25

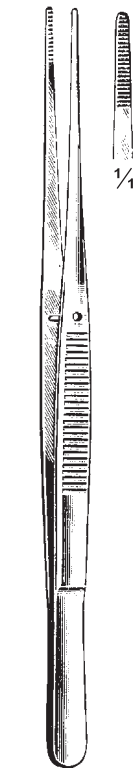

Cushing  
135-04-18  
18 cm / 7"

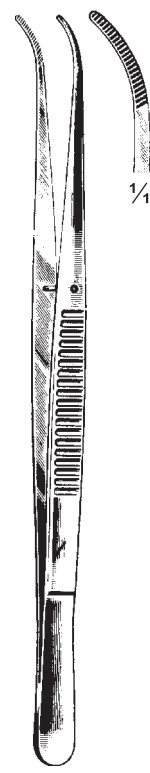

Cushing  
135-05-18  
18 cm / 7"

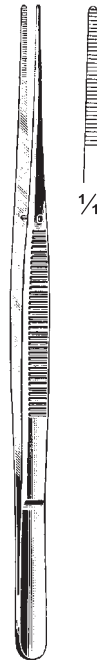

Taylor  
135-06-18 18 cm / 7"  
135-07-20 20 cm / 8"

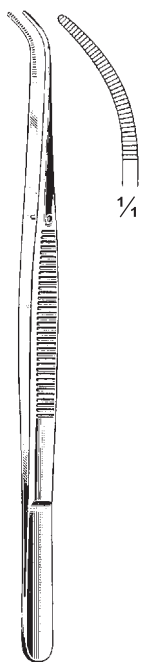

Taylor  
135-08-18 18 cm / 7"  
135-09-20 20 cm / 8"

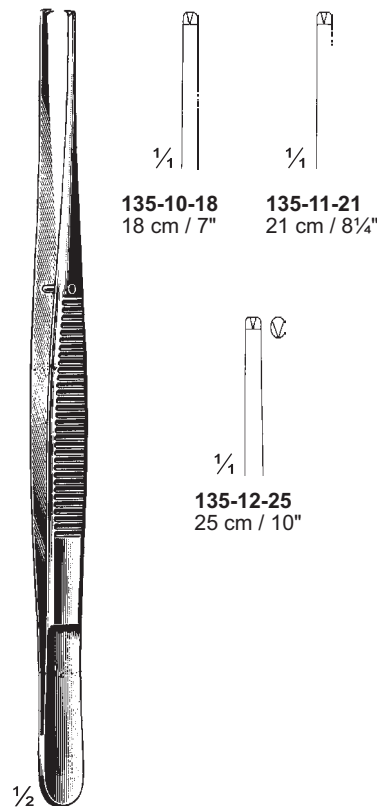

Potts-Smith  
135-10-18 To 135-12-25  
1 X 2 Teeth



Cushing  
135-13-18  
18 cm / 7"

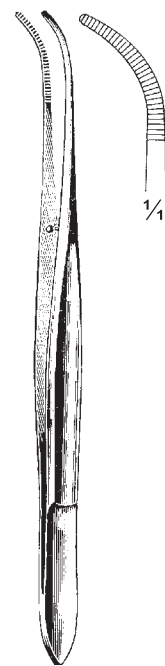

Cushing  
135-14-18  
18 cm / 7"



Cushing  
135-15-18  
18 cm / 7"  
1 X 2 Teeth

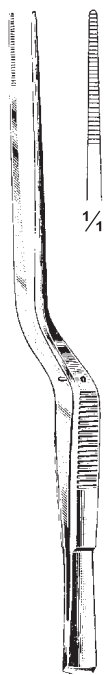

Taylor  
135-16-18 18 cm / 7"  
135-17-20 20 cm / 8"

# Anatomische Pinzettent, Chirurgische Pinzetten Dressing & Tissue Forceps Pincés à dissection, Pincés à dissection à griffes

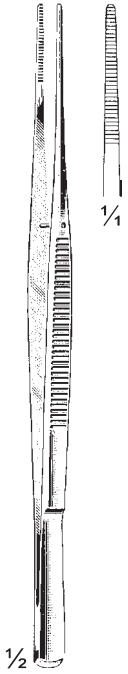

Taylor  
136-01-18 18 cm / 7"  
136-02-20 20 cm / 8"



Taylor  
136-03-18  
18 cm / 7"  
1 X 2 Teeth



Taylor  
136-04-18  
18 cm / 7"  
1 X 2 Teeth



Taylor  
136-05-18  
18 cm / 7"  
1 X 2 Teeth



136-06-12 & 136-07-14  
1 X 2 Teeth



136-06-12  
12.5 cm / 5"

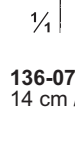

136-07-14  
14 cm / 5 1/2"



136-08-12 To 136-11-20  
1 X 2 Teeth



136-08-12  
12.5 cm / 5"



136-10-18  
18 cm / 7"



136-09-14  
14 cm / 5 1/2"



136-11-20  
20 cm / 8"



Adlerkreutz  
136-12-15 To 136-16-25



136-12-15  
15 cm / 6"  
2 X 3 Teeth



136-13-20  
20 cm / 8"  
2 X 3 Teeth

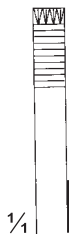

136-14-15  
15 cm / 6"  
4 X 5 Teeth



136-15-20  
20 cm / 8"  
4 X 5 Teeth

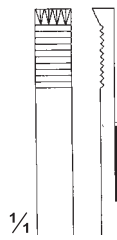

136-16-25  
25 cm / 10"  
4 X 5 Teeth



Skene  
136-17-12 12.5 cm / 5"  
136-18-14 14 cm / 5 1/2"  
136-19-16 16 cm / 6 1/4"  
136-20-18 18 cm / 7"  
1 X 2 Teeth



Skene  
136-21-12 12.5 cm / 5"  
136-22-14 14 cm / 5 1/2"  
136-23-16 16 cm / 6 1/4"  
136-24-18 18 cm / 7"  
2 X 3 Teeth



Skene  
136-25-12 12.5 cm / 5"  
136-26-14 14 cm / 5 1/2"  
136-27-16 16 cm / 6 1/4"  
136-28-18 18 cm / 7"  
3 X 4 Teeth



Skene  
136-29-12 12.5 cm / 5"  
136-30-14 14 cm / 5 1/2"  
136-31-16 16 cm / 6 1/4"  
136-32-18 18 cm / 7"  
4 X 5 Teeth



# Anatomische Pinzettent, Chirurgische Pinzetten Dressing & Tissue Forceps Pincés à dissection, Pincés à dissection à griffes

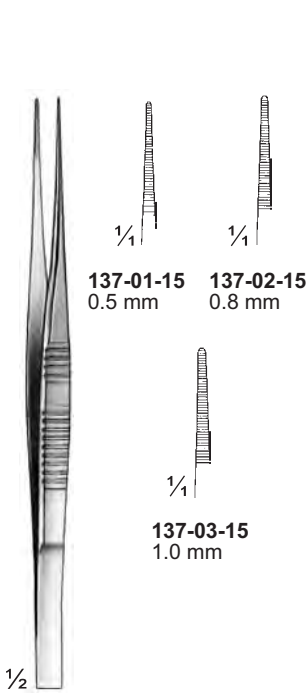

**137-01-15** 0.5 mm  
**137-02-15** 0.8 mm

**137-03-15**  
1.0 mm

**137-01-15 To 137-03-15**  
15.5 cm / 6 1/8"

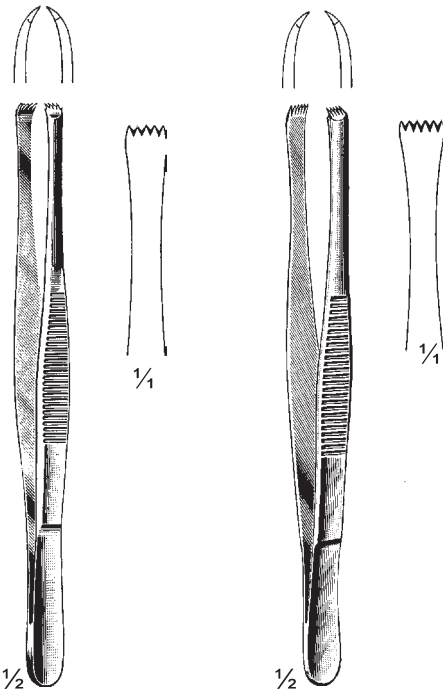

Stone  
**137-04-15**  
15 cm / 6"  
4 X 5 Teeth

Stone  
**137-05-15**  
15 cm / 6"  
5 X 6 Teeth



Lane  
**137-06-12 To 137-25-20**



<b>137-06-12</b> 12.5 cm / 5"	<b>137-11-12</b>
<b>137-07-14</b> 14 cm / 5 1/2"	<b>137-12-14</b>
<b>137-08-16</b> 16 cm / 6 1/4"	<b>137-13-16</b>
<b>137-09-18</b> 18 cm / 7"	<b>137-14-18</b>
<b>137-10-20</b> 20 cm / 8"	<b>137-15-20</b>
1 X 2 Teeth	2 X 3 Teeth



<b>137-16-12</b> 12.5 cm / 5"	<b>137-21-12</b>
<b>137-17-14</b> 14 cm / 5 1/2"	<b>137-22-14</b>
<b>137-18-16</b> 16 cm / 6 1/4"	<b>137-23-16</b>
<b>137-19-18</b> 18 cm / 7"	<b>137-24-18</b>
<b>137-20-20</b> 20 cm / 8"	<b>137-25-20</b>
3 X 4 Teeth	4 X 5 Teeth

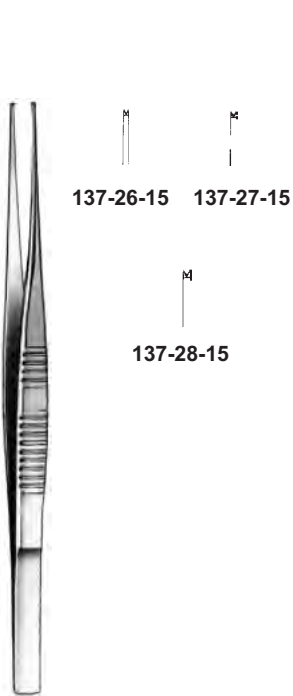

**137-26-15** **137-27-15**

**137-28-15**

**137-26-15 To 137-28-15**  
15 cm / 6"  
1 X 2 Teeth

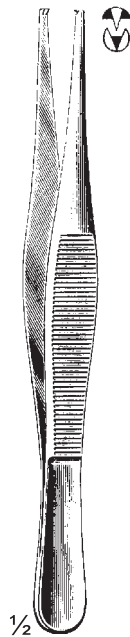

Lexer  
**137-29-17**  
17 cm / 6 3/4"  
1 X 2 Teeth



Gerald  
**137-30-18**  
18 cm / 7"



Gerald  
**137-31-18**  
18 cm / 7"

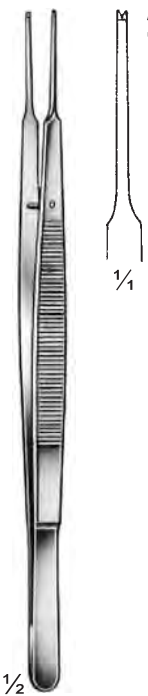

Gerald  
**137-32-18**  
18 cm / 7"  
1 X 2 Teeth



Gerald  
**137-33-18**  
18 cm / 7"  
1 X 2 Teeth

# Anatomische Pinzettent, Chirurgische Pinzetten Dressing & Tissue Forceps Pincès à dissection, Pincès à dissection à griffes

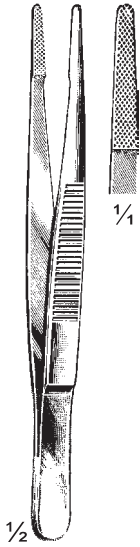

Standard  
138-01-14 14 cm / 5½"  
138-02-17 17 cm / 6¾"



Rochester  
138-03-15 15 cm / 6"  
138-04-16 16 cm / 6¼"  
138-05-18 18 cm / 7"

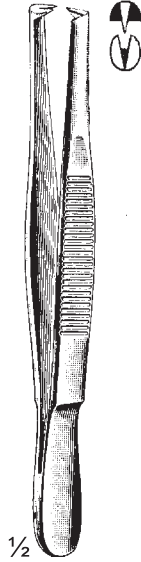

138-06-15  
15 cm / 6"  
1 X 2 Teeth

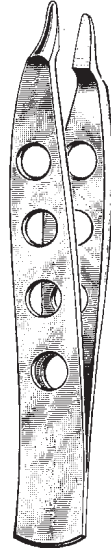

138-07-18  
Smooth Jaws  
138-07-18 To 138-10-18  
18 cm / 7"

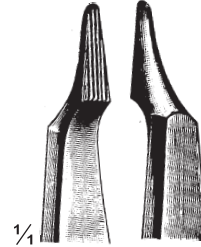

138-08-18

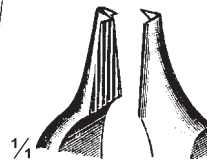

138-09-18  
1 X 2 Teeth

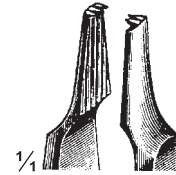

138-10-18  
2 X 3 Teeth



Brown  
138-11-15 15 cm / 6"  
138-12-20 20 cm / 8"



Duval  
138-13-14 To 138-16-15



138-13-14 14 cm / 5½"  
138-14-15 15 cm / 6"

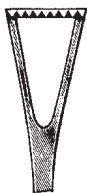

138-15-14 14 cm / 5½"  
138-16-15 15 cm / 6"



Duehrssen  
138-17-19 To 138-19-19  
19 cm / 7½"

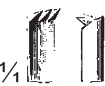

138-18-19  
2 X 3 Teeth



138-19-19  
3 X 4 Teeth



Russ. Model  
138-20-15 To 138-22-25



138-20-15  
15 cm / 6"



138-21-20  
20 cm / 8"



138-22-25  
25 cm / 10"



Durante  
138-23-14 To 138-25-20



138-23-14  
14 cm / 5½"



138-24-16  
16 cm / 6¼"

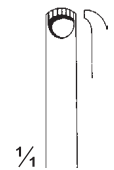

138-25-20  
20 cm / 8"

## Anatomische Pinzettent, Chirurgische Pinzetten Dressing & Tissue Forceps Pincès à dissection, Pincès à dissection à griffes



Hudson (Ewald)  
**139-01-12**  
12 cm / 4 3/4"



Hudson (Ewald)  
**139-02-12**  
12 cm / 4 3/4"  
1 X 2 Teeth



Adson  
**139-03-12**  
12 cm / 4 3/4"



Adson  
**139-04-12**  
12 cm / 4 3/4"  
1 X 2 Teeth



Micro-Adson  
**139-05-12**  
12 cm / 4 3/4"



Micro-Adson  
**139-06-12**  
12 cm / 4 3/4"  
1 X 2 Teeth



Micro-Adson  
**139-07-15**  
15 cm / 6"



Micro-Adson  
**139-08-15**  
15 cm / 6"  
1 X 2 Teeth



Adson-Brown  
**139-09-12**  
12 cm / 4 3/4"



Adson-Brown  
**139-10-12**  
12 cm / 4 3/4"

# Anatomische Pinzettent, Chirurgische Pinzetten Dressing & Tissue Forceps Pincès à dissection, Pincès à dissection à griffes



Adson  
140-01-12  
12 cm / 4 3/4"



Adson  
140-02-12  
12 cm / 4 3/4"  
1 X 2 Teeth



Adson-Brown  
140-03-12  
12 cm / 4 3/4"



1/4



Adson-Graefe  
140-04-12  
12 cm / 4 3/4"  
4 X 5 Teeth



1/4



Thorpe  
140-05-12  
12 cm / 4 3/4"



1/4



140-06-10 To 140-08-10  
10 cm / 4"



1/4



1/4



1/4

140-08-10



Bonaccollo  
140-09-11  
11 cm / 4 1/4"



1/4



Adson  
140-10-12  
12 cm / 4 3/4"  
1 X 2 Teeth



1/4



Adson  
140-11-12  
12 cm / 4 3/4"  
1 X 2 Teeth



1/4



Adson  
140-12-12  
12 cm / 4 3/4"  
1 X 2 Teeth

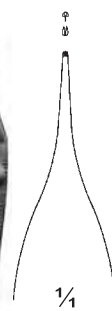

1/4



Adson  
140-13-12  
12 cm / 4 3/4"  
1 X 2 Teeth



1/4



Adson  
140-14-15  
15 cm / 6"  
1 X 2 Teeth



1/4



Micro-Adson-Biemer  
140-15-12  
12 cm / 4 3/4"  
1 X 2 Teeth



1/4

**Anatomische Pinzette, Chirurgische Pinzette**  
**Dressing & Tissue Forceps**  
**Pinces à dissection, Pinces à dissection à griffes**

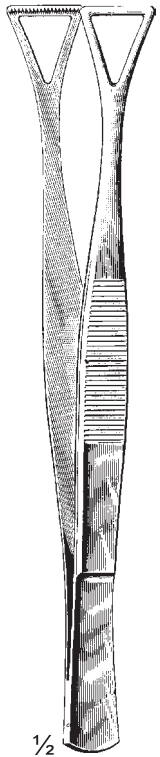

1/2  
 Collin-Duval  
 141-01-14 To 141-03-27  
 20 cm / 8"

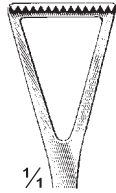

1/4  
 141-01-14  
 14 mm

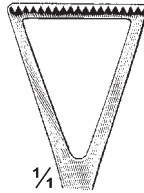

1/4  
 141-02-18  
 18 mm

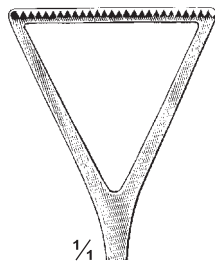

1/4  
 141-03-27  
 27 mm



1/2  
 Hepp/Scheidel  
 141-04-18  
 18 cm / 7"

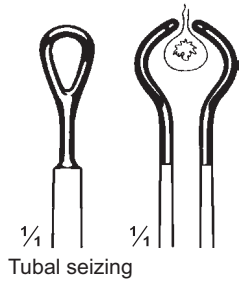

1/4  
 Tubal seizing



1/2  
 141-05-21  
 21 cm / 8 1/4"  
 Catheter seizing

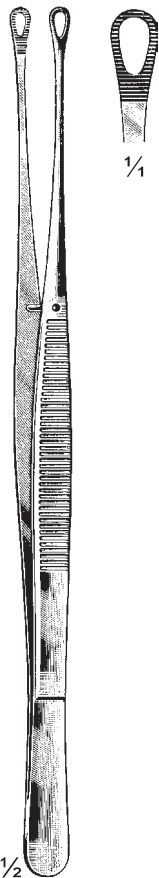

1/2  
 Singley-Tuttle  
 141-06-23 23 cm / 9"  
 141-07-25 25 cm / 10"

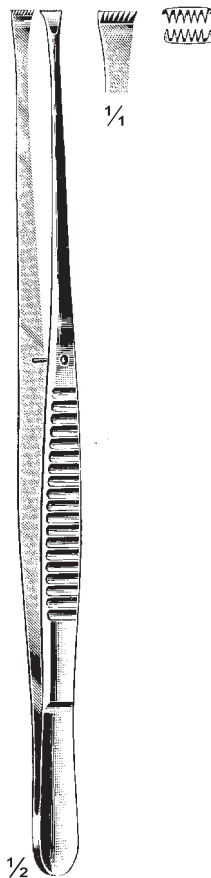

1/2  
 Nelson  
 141-08-23 23 cm / 9"  
 141-09-25 25 cm / 10"  
 6 X 7 Teeth

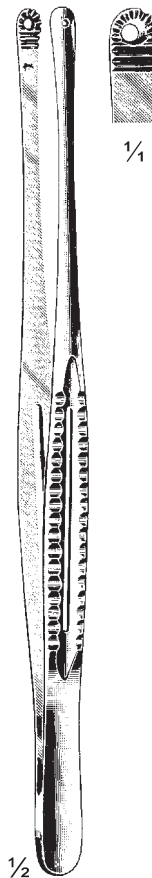

1/2  
 Mayo-Russian  
 141-10-23  
 23 cm / 9"

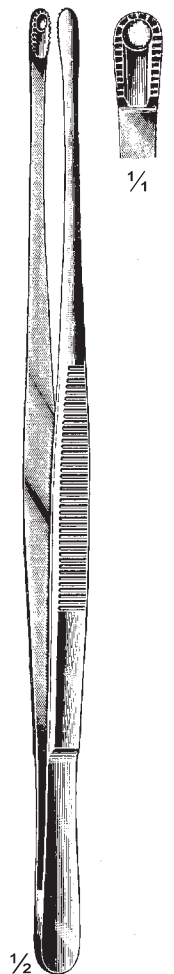

1/2  
 Davis  
 141-11-25  
 25 cm / 10"

# Anatomische Pinzette, Chirurgische Pinzette Dressing & Tissue Forceps Pinces à dissection, Pinces à dissection à griffes



Lucae  
142-01-14  
14 cm / 5½"



Lucae  
142-02-14  
14 cm / 5½"



Lucae  
142-03-14  
14 cm / 5½"  
1 X 2 Teeth



142-04-16



142-05-16  
1 X 2 Teeth

142-04-16 & 142-05-16  
16.5 cm / 6½"

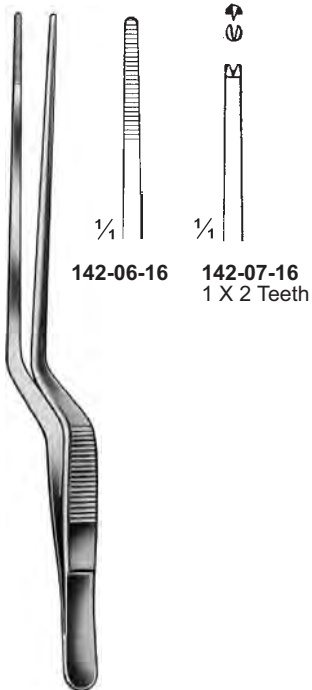

142-06-16

142-07-16  
1 X 2 Teeth

Gruenwald (Jansen)  
142-06-16 & 142-07-16  
16 cm / 6¼"

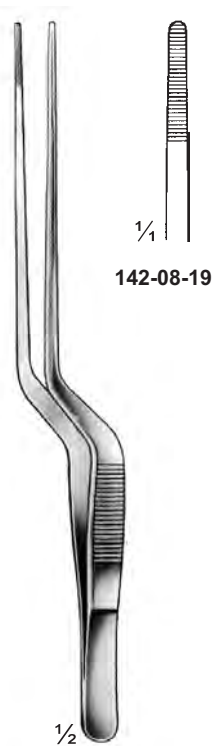

142-08-19

142-09-19  
1 X 2 Teeth

Gruenwald  
142-08-19 & 142-09-19  
19.5 cm / 7¾"

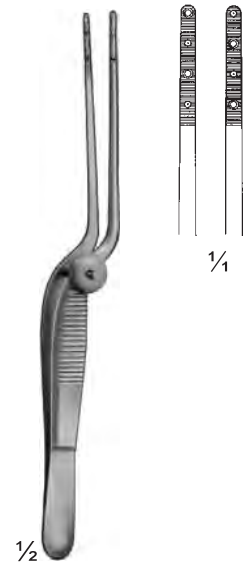

Cottle  
142-10-14  
14 cm / 5½"

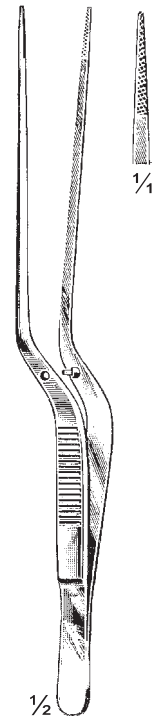

Gruenwald  
142-11-18  
18.5 cm / 7¼"



## Anatomische Pinzette, Chirurgische Pinzette Dressing & Tissue Forceps Pinces à dissection, Pinces à dissection à griffes

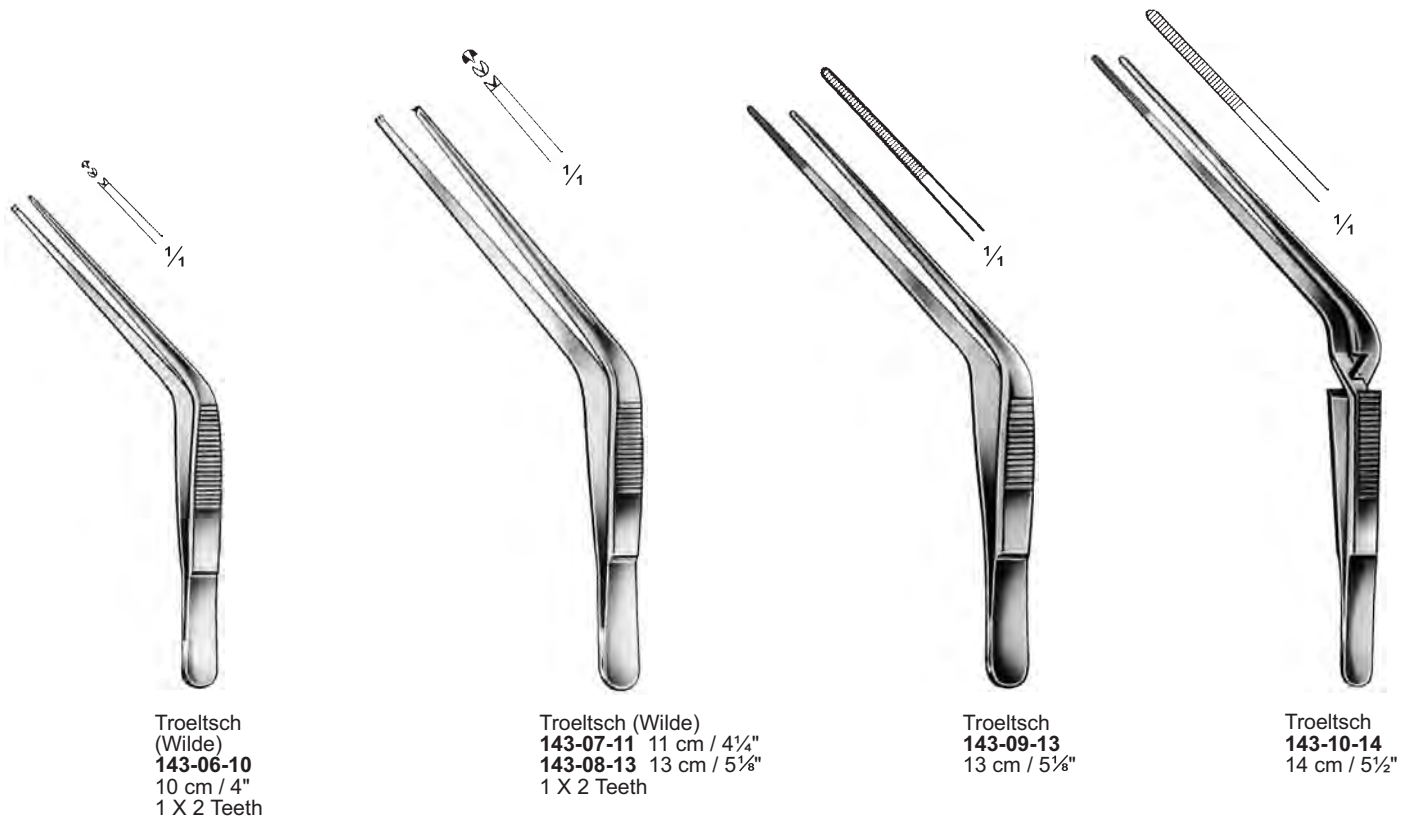
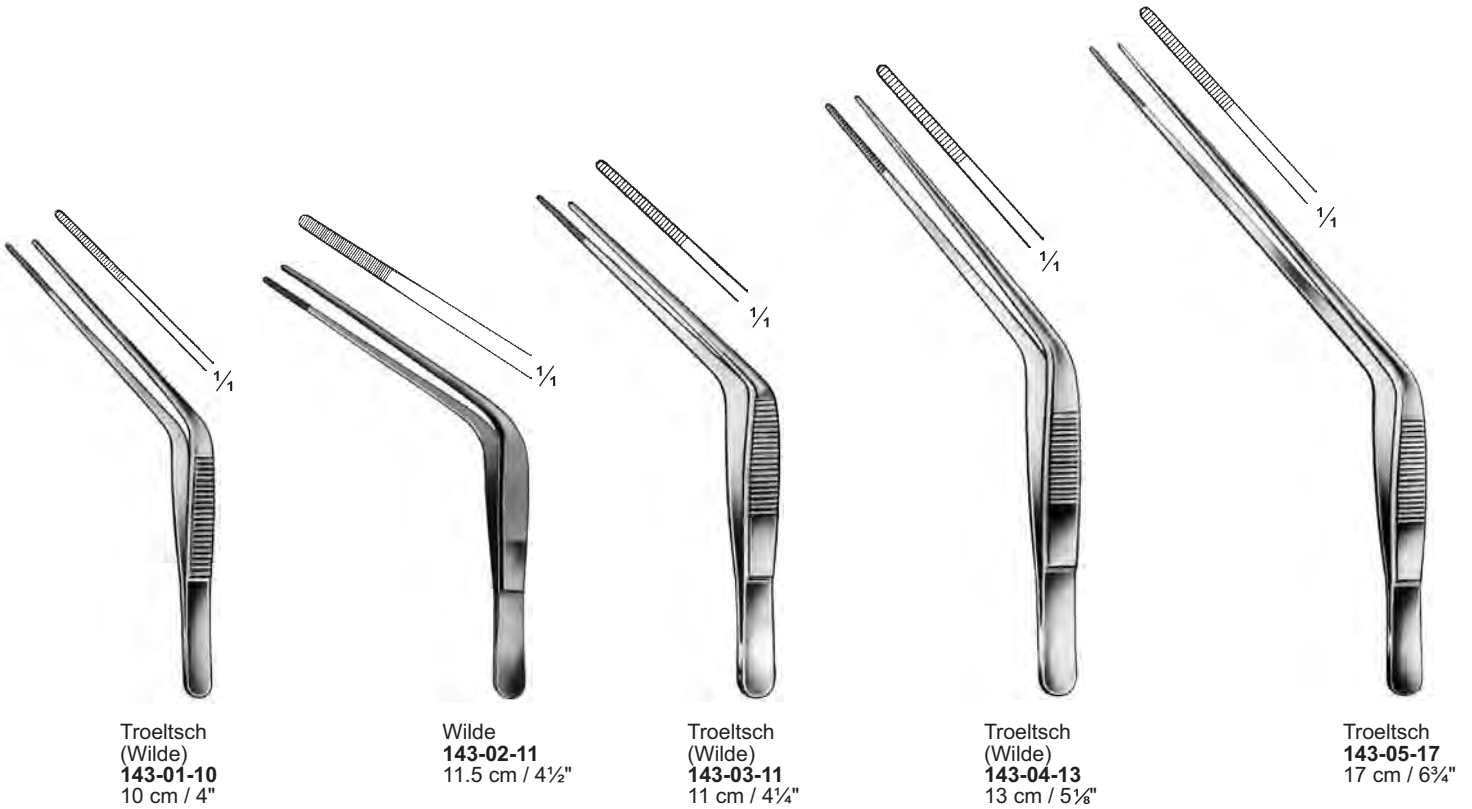



$\frac{2}{3}$



$\frac{2}{3}$



$\frac{2}{3}$



$\frac{2}{3}$



$\frac{2}{3}$



$\frac{2}{3}$

**144-01-08** 8 cm / 3 $\frac{1}{4}$ "  
**144-02-09** 9 cm / 3 $\frac{1}{2}$ "  
**144-03-10** 10 cm / 4"  
**144-04-11** 11 cm / 4 $\frac{1}{4}$ "  
**144-05-12** 12 cm / 4 $\frac{3}{4}$ "

**144-06-08** 8 cm / 3 $\frac{1}{4}$ "  
**144-07-09** 9 cm / 3 $\frac{1}{2}$ "  
**144-08-10** 10 cm / 4"  
**144-09-11** 11 cm / 4 $\frac{1}{4}$ "  
**144-10-12** 12 cm / 4 $\frac{3}{4}$ "

**144-11-08** 8 cm / 3 $\frac{1}{4}$ "  
**144-12-09** 9 cm / 3 $\frac{1}{2}$ "  
**144-13-10** 10 cm / 4"  
**144-14-11** 11 cm / 4 $\frac{1}{4}$ "  
**144-15-12** 12 cm / 4 $\frac{3}{4}$ "

**144-16-08** 8 cm / 3 $\frac{1}{4}$ "  
**144-17-09** 9 cm / 3 $\frac{1}{2}$ "  
**144-18-10** 10 cm / 4"  
**144-19-11** 11 cm / 4 $\frac{1}{4}$ "  
**144-20-12** 12 cm / 4 $\frac{3}{4}$ "  
 1 X 2 Teeth

**144-21-08** 8 cm / 3 $\frac{1}{4}$ "  
**144-22-09** 9 cm / 3 $\frac{1}{2}$ "  
**144-23-10** 10 cm / 4"  
**144-24-11** 11 cm / 4 $\frac{1}{4}$ "  
**144-25-12** 12 cm / 4 $\frac{3}{4}$ "  
 1 X 2 Teeth

**144-26-08** 8 cm / 3 $\frac{1}{4}$ "  
**144-27-09** 9 cm / 3 $\frac{1}{2}$ "  
**144-28-10** 10 cm / 4"  
**144-29-11** 11 cm / 4 $\frac{1}{4}$ "  
**144-30-12** 12 cm / 4 $\frac{3}{4}$ "  
 1 X 2 Teeth

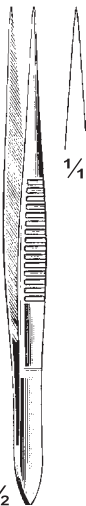

$\frac{1}{4}$

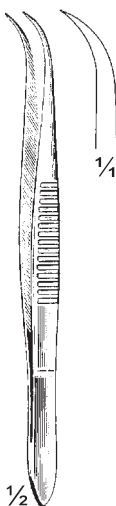

$\frac{1}{4}$

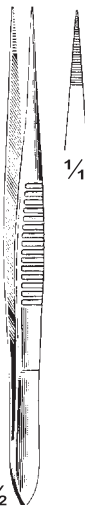

$\frac{1}{4}$

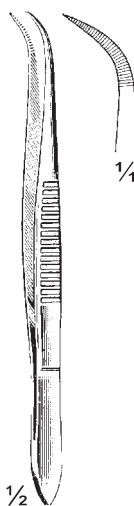

$\frac{1}{4}$



$\frac{1}{4}$

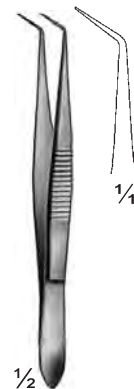

$\frac{1}{4}$



$\frac{1}{4}$

**144-31-08** 8 cm / 3 $\frac{1}{4}$ "  
**144-32-09** 9 cm / 3 $\frac{1}{2}$ "  
**144-33-10** 10.5 cm / 4 $\frac{1}{6}$ "  
**144-34-11** 11.5 cm / 4 $\frac{1}{2}$ "  
**144-35-12** 12.5 cm / 5"  
**144-36-15** 15 cm / 6"

**144-37-08**  
**144-38-09**  
**144-39-10**  
**144-40-11**  
**144-41-12**  
**144-42-15**

**144-43-08** 8 cm / 3 $\frac{1}{4}$ "  
**144-44-09** 9 cm / 3 $\frac{1}{2}$ "  
**144-45-10** 10.5 cm / 4 $\frac{1}{6}$ "  
**144-46-11** 11.5 cm / 4 $\frac{1}{2}$ "  
**144-47-12** 12.5 cm / 5"  
**144-48-15** 15 cm / 6"

**144-49-08**  
**144-50-09**  
**144-51-10**  
**144-52-11**  
**144-53-12**  
**144-54-15**

**144-55-10**  
 10 cm / 4"

**144-56-10**  
 10 cm / 4"

**144-57-10**  
 10 cm / 4"

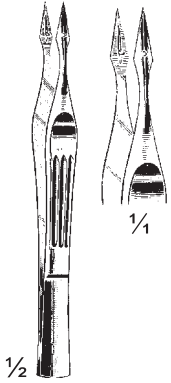

Carmalt  
**145-01-10** 10 cm / 4"  
**145-02-11** 11.5 cm / 4½"

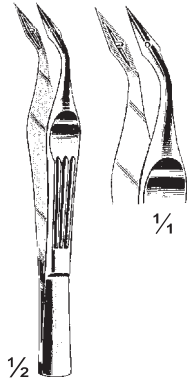

Carmalt  
**145-03-10** 10 cm / 4"  
**145-04-11** 11.5 cm / 4½"



**145-05-11** 11 cm / 4¼"  
**145-06-12** 12 cm / 4¾"  
**145-07-12** 12.5 cm / 5"



Hunter  
**145-08-10** 10 cm / 4"  
**145-09-11** 11 cm / 4¼"



Hunter  
**145-10-10** 10 cm / 4"  
**145-11-11** 11 cm / 4¼"



Walter  
**145-12-11**  
 11 cm / 4¼"



Walter  
**145-13-11**  
 11 cm / 4¼"

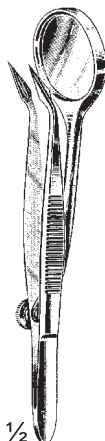

**145-14-10**  
 10 cm / 4"



**145-15-11**  
 11 cm / 4¼"

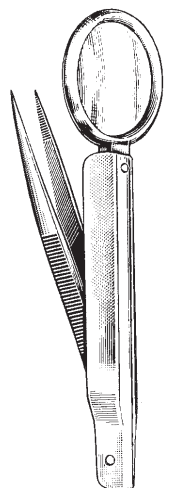

**145-16-08**  
 8 cm / 3"

# Splitterpinzetten Splinter Forceps Pincès à échardes

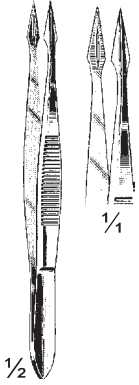

Hunter  
146-01-10 10 cm / 4"  
146-02-11 11.5 cm / 4½"

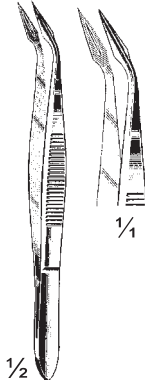

Hunter  
146-03-10 10 cm / 4"  
146-04-11 11.5 cm / 4½"

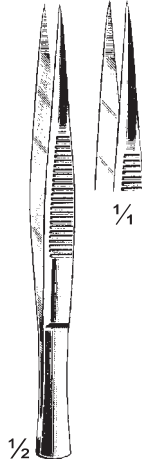

146-05-07 7.5 cm / 3"  
146-06-09 9 cm / 3½"  
146-07-10 10.5 cm / 4¼"  
146-08-11 11.5 cm / 4½"  
146-09-12 12 cm / 4¾"  
146-10-12 12.5 cm / 5"



146-11-08 8 cm ⅝" "  
146-12-09 9 cm / 3½"  
146-13-10 10.5 cm / 4¼"  
146-14-11 11.5 cm / 4½"



146-15-08 8 cm / 3⅛"  
146-16-09 9 cm / 3½"  
146-17-10 10.5 cm / 4¼"  
146-18-11 11.5 cm / 4½"



146-19-10  
10 cm / 4"



146-20-10  
10 cm / 4"

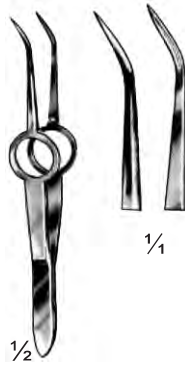

Schaaf  
146-21-09 9 cm / 3½"  
146-22-10 10 cm / 4"

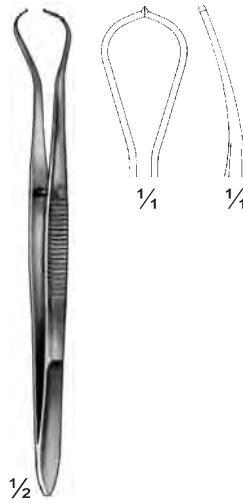

Droeber  
146-23-13  
13 cm / 5⅛"



146-24-09 9 cm / 3½"  
146-25-10 10 cm / 4"  
146-26-11 11.5 cm / 4½"



146-27-07 7.5 cm / 3"  
146-28-09 9.5 cm / 3¾"  
146-29-10 10.5 cm / 4¼"  
146-30-11 11.5 cm / 4½"  
146-31-12 12 cm / 4¾"  
146-32-12 12.5 cm / 5"  
146-33-16 16 cm / 6¼"  
146-34-18 18 cm / 7"

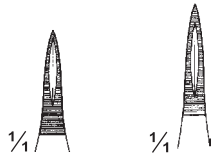

**147-01-07**  
7.5 cm / 3"

**147-02-09**  
9.5 cm / 3¾"



**147-03-11**  
11.5 cm / 4½"



Vanguard  
**147-04-13**  
Handle size  
13 cm / 5½"

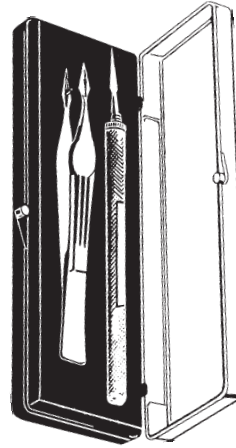

**147-05-00**  
Splinter removal kit  
Comprising of items  
145-02-09 and 147-04-13

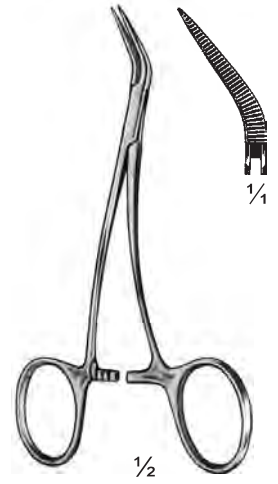

Peet  
**147-06-11**  
11.5 cm / 4½"

Feilchenfeld  
**147-01-07 To 147-03-11**

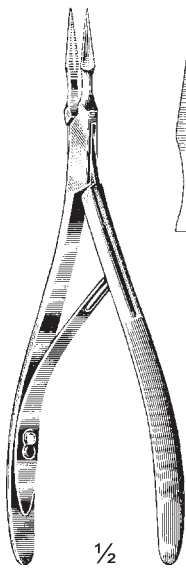

Ralk  
**147-07-15**  
15 cm / 6"

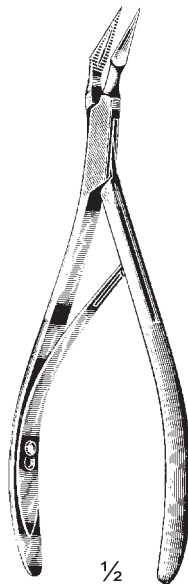

Ralk  
**147-08-15**  
15 cm / 6"

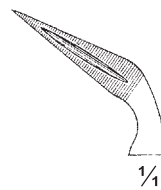

**147-09-14**  
Ralk (Virtus)  
**147-09-14 & 147-10-14**  
14 cm / 5½"

# Cilienpinzetten Cilia Forceps Pincès à épiler les cils

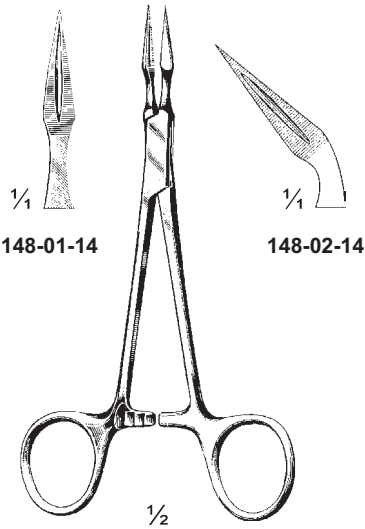

148-01-14

148-02-14

Stieglitz  
148-01-14 & 148-02-14  
14 cm / 5½"

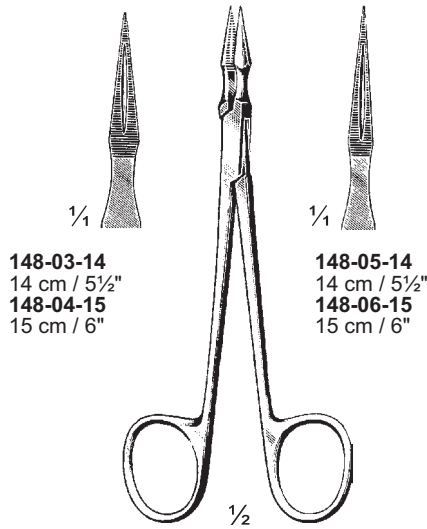

148-03-14  
14 cm / 5½"  
148-04-15  
15 cm / 6"

148-05-14  
14 cm / 5½"  
148-06-15  
15 cm / 6"

Steiglitz  
148-03-14 To 148-06-15

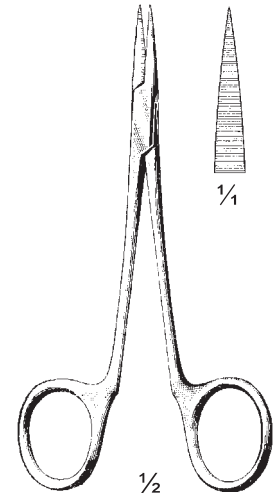

Physician  
148-07-13  
13 cm / 5¼"

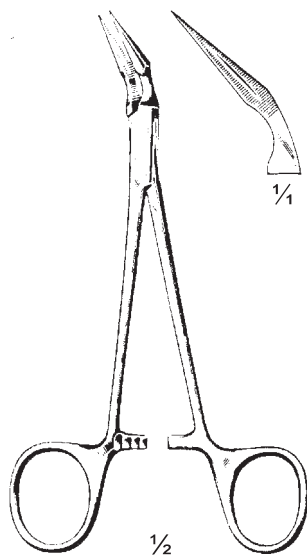

Stieglitz  
148-08-14  
14 cm / 5½"

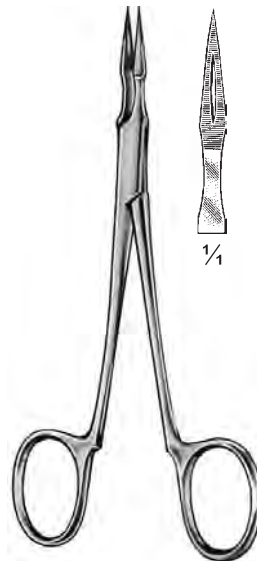

Arthur  
148-09-14  
14 cm / 5½"

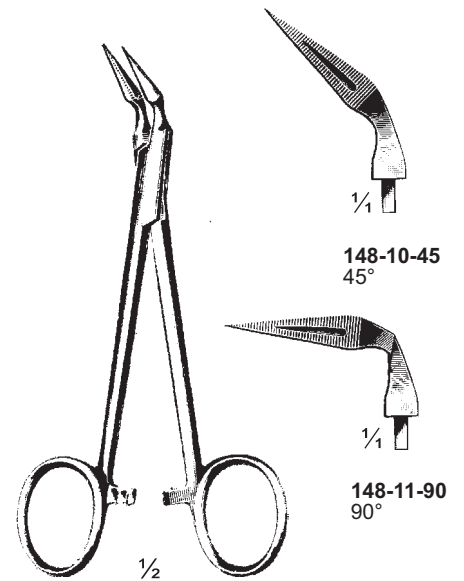

148-10-45  
45°

148-11-90  
90°

Stieglitz (Williams)  
148-10-45 & 148-11-90  
14 cm / 5½"



# Cilienpinzetten Cilia Forceps Pincès à épiler les cils

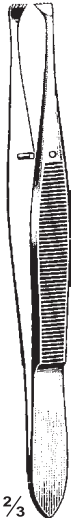

2/3  
Graefe  
149-01  
10.5 cm / 4 1/8"



Ziegler  
149-02  
9 cm / 3 1/2"



1/1  
Douglas  
149-03  
7 cm / 2 3/4"

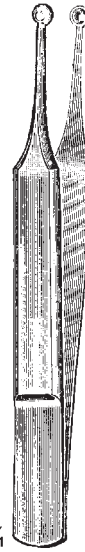

1/1  
Bennett  
149-04  
7 cm / 2 3/4"



1/1  
149-05 7 cm / 2 3/4"  
149-06 8 cm / 3 1/4"

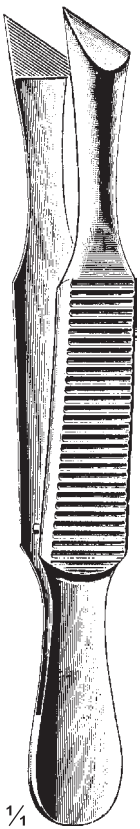

1/1  
Bergh  
149-07-10  
10.5 cm / 4 1/8"

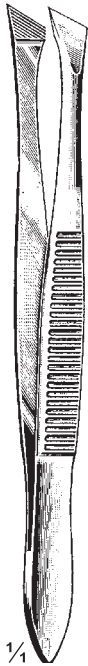

1/1  
Bergh  
149-08-08 8 cm / 3 1/4"  
149-09-09 9 cm / 3 1/2"  
149-10-10 10 cm / 4"



1/1  
Littauer  
149-11-08 8 cm / 3 1/4"  
149-12-09 9 cm / 3 1/2"  
149-13-10 10 cm / 4"



1/1  
Douglas  
149-14-08 8 cm / 3 1/4"  
149-15-09 9 cm / 3 1/2"  
149-16-10 10 cm / 4"

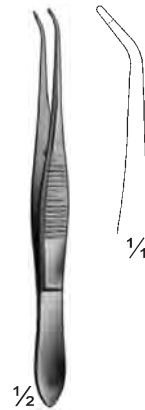

1/2  
Saupe  
149-17-10  
10.5 cm / 4 1/8"

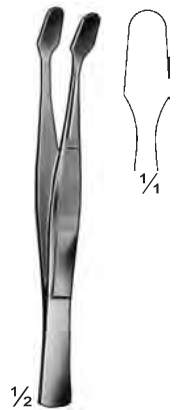

1/1  
Kühne  
149-18-10  
10.5 cm / 4 1/8"

**Cilienpinzetten**  
**Cilia Forceps**  
**Pinces à épiler les cils**

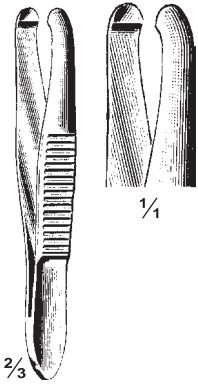

Beer  
 150-01-06 6 cm / 2 1/4"  
 150-02-08 8 cm / 3 1/4"

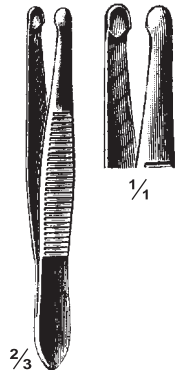

Beer  
 150-03-08 8 cm / 3 1/4"

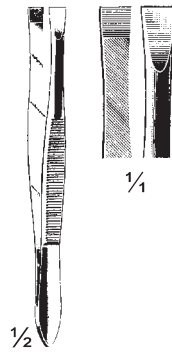

Gouglas  
 150-04-09 9 cm / 3 1/2"

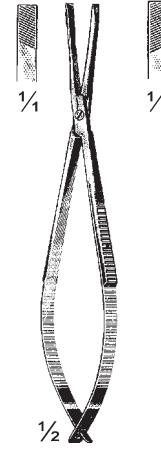

Henry  
 150-05-12 12 cm / 4 3/4"



Gradle  
 150-06-10 10 cm / 4"



Beaupre  
 150-07-12 12 cm / 4 3/4"



Automatic  
 150-08-10 10 cm / 4"

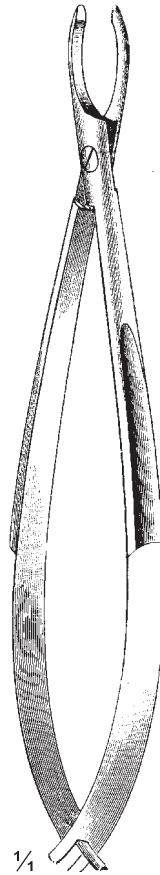

150-09-11  
 11.5 cm / 4 1/2"



Phillips  
 150-10-09 9 cm / 3 1/2"



Jameson-Evans  
 150-11-11 11 cm / 4 1/4"

# Besondere Zange Special Forceps Forceps Speciaux



Hunt  
**151-01-20**  
20 cm / 8"  
Tumor and  
vessel forceps



Hunt  
**151-02-20**  
20 cm / 8"  
Tumor and  
vessel forceps



Heifetz  
**151-03-03 & 151-04-05**  
22 cm / 8 3/4"  
Tumor and  
vessel forceps

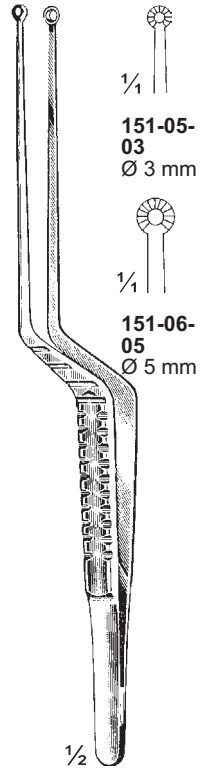

Yasargil  
**151-05-03 & 151-06-05**  
20 cm / 8"  
Tumor and  
vessel forceps



Yasargil  
**151-07-03 & 151-08-05**  
20 cm / 8"  
Spoon type sharp



Yasargil  
**151-09-03 & 151-10-05**  
22 cm / 8 3/4"  
Tumor forceps

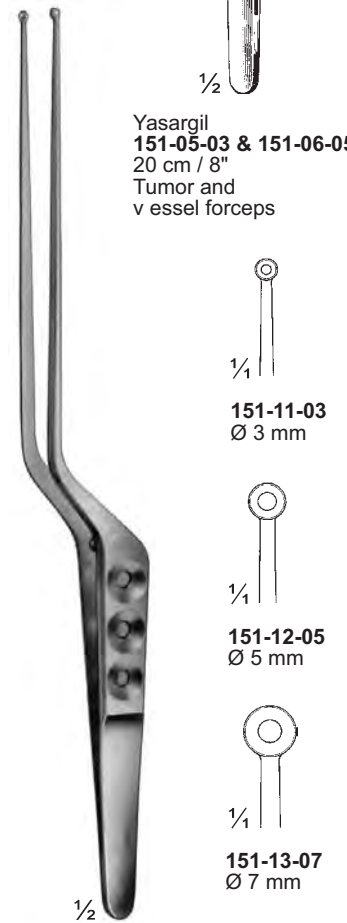

Yasargil-Samii  
**151-11-03 To 151-13-07**  
24 cm / 9 1/2"  
Tumor forceps  
Spoon type sharp

# Besondere Zange Special Forceps Forceps Speciaux

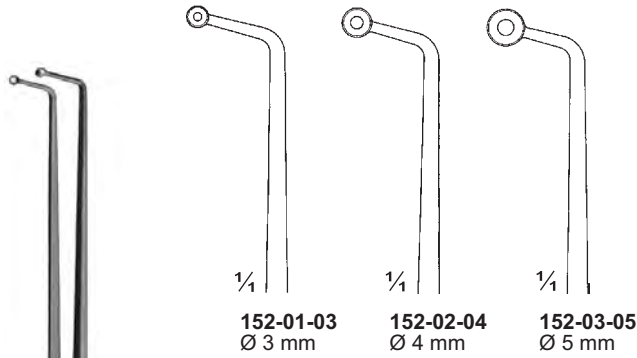

152-01-03 Ø 3 mm  
152-02-04 Ø 4 mm  
152-03-05 Ø 5 mm

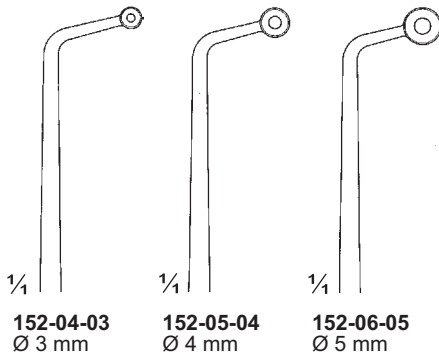

152-04-03 Ø 3 mm  
152-05-04 Ø 4 mm  
152-06-05 Ø 5 mm

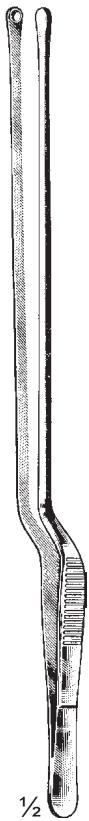

Adson  
152-23-21  
21.5 cm / 8½"  
Hypophyseal forceps

Samii  
152-01-03 To 152-06-05  
23 cm / 9"  
Tumor forceps  
Spoon type sharp

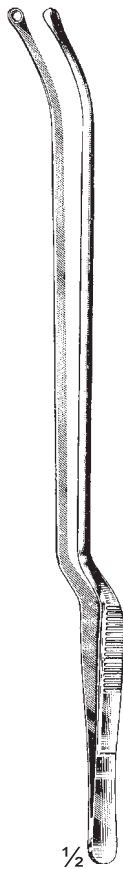

Adson  
152-24-21  
21.5 cm / 8½"  
Hypophyseal forceps



Tying  
152-25-15 To 152-60-20



De Bakey  
152-07-15 To 152-22-24

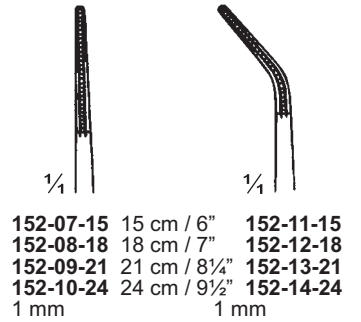

152-07-15 15 cm / 6"  
152-08-18 18 cm / 7"  
152-09-21 21 cm / 8¼"  
152-10-24 24 cm / 9½"  
1 mm

152-11-15  
152-12-18  
152-13-21  
152-14-24  
1 mm

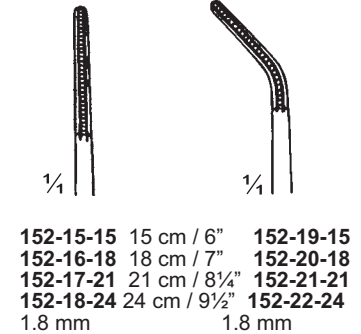

152-15-15 15 cm / 6"  
152-16-18 18 cm / 7"  
152-17-21 21 cm / 8¼"  
152-18-24 24 cm / 9½"  
1.8 mm

152-19-15  
152-20-18  
152-21-21  
152-22-24  
1.8 mm



152-25-15 152-31-15 15 cm / 6"  
152-26-18 152-32-18 18 cm / 7"  
152-27-20 152-33-20 20 cm / 8"  
Jaw 0.4 X 6 mm

152-37-15 152-43-15  
152-38-18 152-44-18  
152-39-20 152-45-20  
Jaw 0.4 X 6 mm  
1 X 2 Teeth

152-28-15 152-34-15 15 cm / 6"  
152-29-18 152-35-18 18 cm / 7"  
152-30-20 152-36-20 20 cm / 8"  
Jaw 0.8 X 6 mm

152-40-15 152-46-15  
152-41-18 152-47-18  
152-42-20 152-48-20  
Jaw 0.8 X 6 mm  
1 X 2 Teeth

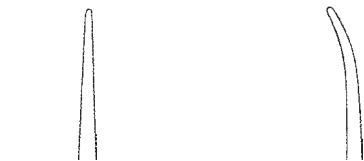

152-49-15 15 cm / 6" 0.4 mm  
152-50-15 15 cm / 6" 0.8 mm  
152-51-18 18 cm / 7" 0.4 mm  
152-52-18 18 cm / 7" 0.8 mm  
152-53-20 20 cm / 8" 0.4 mm  
152-54-20 20 cm / 8" 0.8 mm

152-55-15  
152-56-15  
152-57-18  
152-58-18  
152-59-20  
152-60-20

# Besondere Zange Special Forceps Forceps Speciaux



1/4  
153-01-06  
0.6 mm



1/4  
153-02-09  
0.9 mm



1/4  
153-03-01  
1 X 2 Teeth

1/2  
Yasargil  
153-06-03 To 153-03-01  
18 cm / 7"



1/4  
153-04-06  
20 cm / 8"  
0.6 mm



1/4  
153-05-09  
20 cm / 8"  
0.9 mm



1/4  
153-06-06  
22 cm / 8 3/4"  
0.6 mm



1/4  
153-07-09  
22 cm / 8 3/4"  
0.9 mm

1/2  
Yasargil  
153-04-06 To 153-07-09



1/4  
153-08-06  
0.6 mm



1/4  
153-09-09  
0.9 mm

1/2  
Yasargil  
153-08-06- & 153-09-09  
24 cm / 9 1/2"



1/2  
153-10-15 To 153-25-24



1/4



1/4

Ring Ø  
0.5 X 1.0 mm 153-10-15 15 cm / 6" 153-14-15  
0.5 X 1.0 mm 153-11-18 18 cm / 7" 153-15-18  
0.5 X 1.0 mm 153-12-21 21 cm / 8 1/4" 153-16-21  
0.5 X 1.0 mm 153-13-24 24 cm / 9 1/2" 153-17-24



1/4



1/4

Ring Ø  
1.5 X 2.0 mm 153-18-15 15 cm / 6" 153-22-15  
1.5 X 2.0 mm 153-19-18 18 cm / 7" 153-23-18  
1.5 X 2.0 mm 153-20-21 21 cm / 8 1/4" 153-24-21  
1.5 X 2.0 mm 153-21-24 24 cm / 9 1/2" 153-25-24

# Anatomische Mikropinzetten Micro Forceps Micro-Pinces à dissection



Gerald  
**154-01-18**  
18 cm / 7"



Gerald  
**154-02-18**  
18 cm / 7"  
1 X 2 Teeth

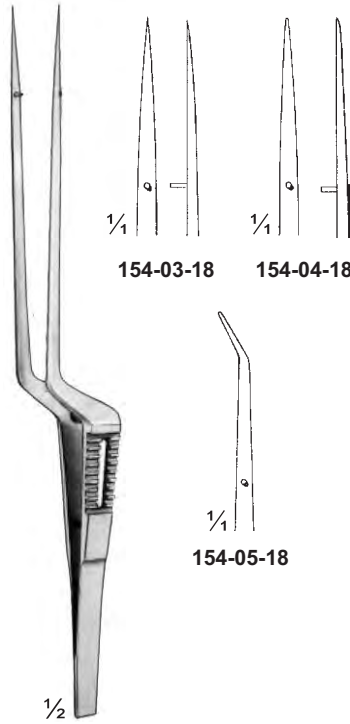

**154-03-18 To 154-05-18**  
18.5 cm / 7 1/4"

Item No. 154-08-12 To 154-12-16  
also available in 18/8 stainless



**154-06-22 & 154-07-22**  
22 cm / 8 3/4"

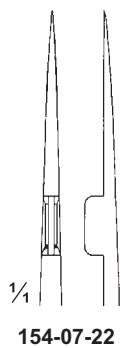

**154-06-22**



**154-07-22**



**154-08-12**  
12.5 cm / 5"



**154-09-12**  
12.5 cm / 5"



**154-10-12**  
12.5 cm / 5"



Gomel  
**154-11-16**  
16 cm / 6 1/4"



Gomel  
**154-12-16**  
16 cm / 6 1/4"  
1 X 2 Teeth



Also available in 18/8 stainless



**155-01-10**  
10 cm / 4"



**155-02-10**  
10 cm / 4"



**155-03-10**  
10 cm / 4"



**155-04-14**  
14 cm / 5½"



**155-05-14**  
14 cm / 5½"



**155-06-10**  
10.5 cm / 4¼"



**155-07-10**  
10.5 cm / 4¼"



**155-08-11**  
11.5 cm / 4½"



**155-09-11**  
11.5 cm / 4½"



**155-10-10**  
10.5 cm / 4¼"



**155-11-10**  
10.5 cm / 4¼"



**155-12-10**  
10.5 cm / 4¼"

# Anatomische Mikropinzetten Micro Forceps Micro-Pinces à dissection



Jacobson-Adson  
**156-01-12**  
12 cm / 4¾"



Jacobson-Adson  
**156-02-15**  
15 cm / 6"

Item No. 156-03-14 To 156-14-18  
also available in 18/8 stainless



**156-07-15 To 156-10-18**



**156-11-15 To 156-14-18**



**156-03-12 & 156-04-12**  
12 cm / 4¾"



**156-05-12 & 156-06-12**  
12 cm / 4¾"



**156-07-15**  
15 cm / 6"  
**156-08-18**  
18 cm / 7"

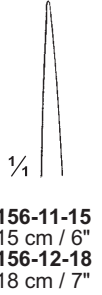

**156-11-15**  
15 cm / 6"  
**156-12-18**  
18 cm / 7"



**156-09-15**  
15 cm / 6"  
**156-10-18**  
18 cm / 7"



**156-13-15**  
15 cm / 6"  
**156-14-18**  
18 cm / 7"

# Anatomische Mikropinzetten Micro Forceps Micro-Pinces à dissection

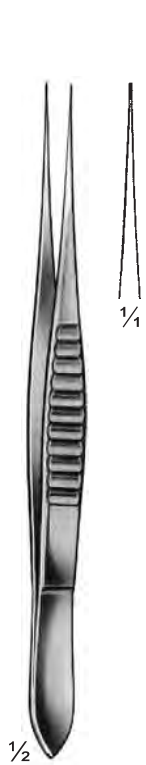

Jacobson  
157-01-11 11 cm / 4 1/4"  
157-02-15 15 cm / 6"  
157-03-18 18 cm / 7"

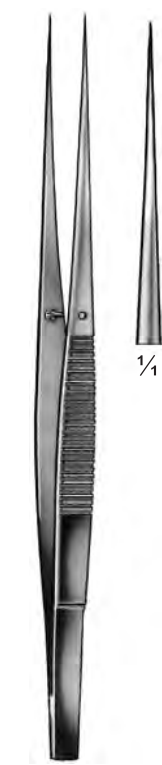

157-04-19  
19.5 cm / 7 3/4"

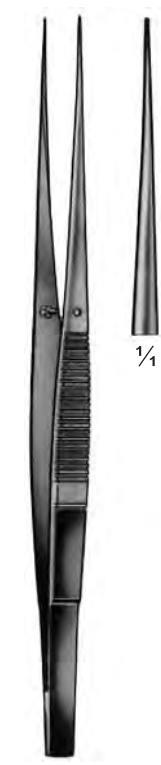

157-05-19  
19.5 cm / 7 3/4"



157-06-19  
19.5 cm / 7 3/4"



157-07-19  
19.5 cm / 7 3/4"



157-08-19  
19.5 cm / 7 3/4"



157-09-19  
19 cm / 7 1/2"



Yasargil  
157-10-18  
18.5 cm / 7 1/4"



Brock  
157-11-15  
15 cm / 6"

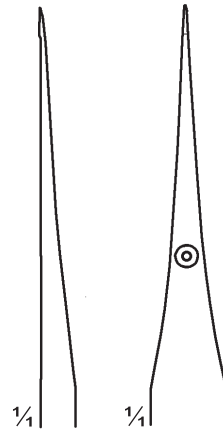

1/4

1/4



1/2

Brock  
157-12-18  
18 cm / 7"

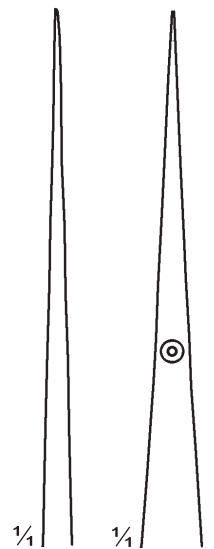

1/4

1/4

# Anatomische Mikropinzetten Micro Forceps Micro-Pinces à dissection

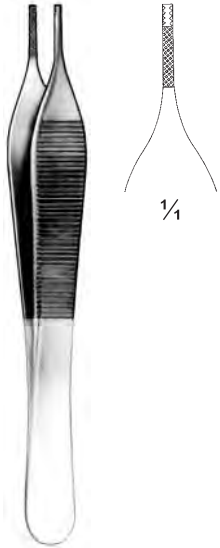

Adson-Brown  
158-01-12  
12 cm / 4 3/4"

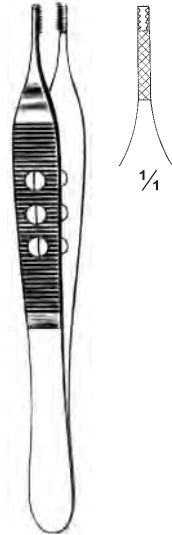

Adson-Brown  
158-02-12  
12 cm / 4 3/4"



Adson  
158-03-15 To 158-07-12  
1 X 2 Teeth

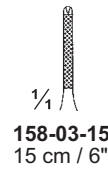

158-03-15  
15 cm / 6"

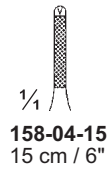

158-04-15  
15 cm / 6"

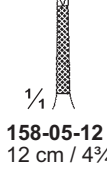

158-05-12  
12 cm / 4 3/4"

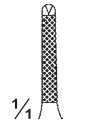

158-06-12  
12 cm / 4 3/4"



158-07-12  
12 cm / 4 3/4"

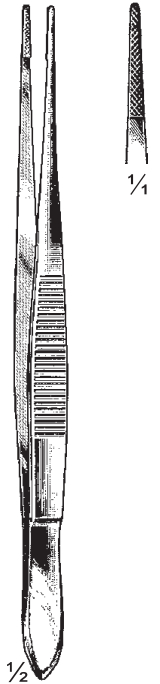

Cushing  
158-08-18  
18 cm / 7"



Adson  
158-09-12 To 158-12-15

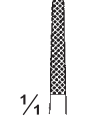

158-09-12  
12 cm / 4 3/4"



158-10-12  
12 cm / 4 3/4"

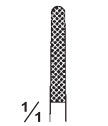

158-11-15  
15 cm / 6"

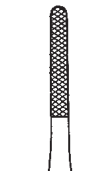

158-12-15  
15 cm / 6"



USA Dressing Forceps  
158-13-12 12 cm / 4 3/4"  
158-14-14 14 cm / 5 1/2"  
158-15-15 15 cm  
158-15-16 16 cm / 6 1/4"  
158-16-18 18 cm / 7"  
158-17-20 20 cm / 8"  
158-17-21 21 cm / 4 3/4"  
158-18-25 25 cm / 10"



Oehler  
158-19-14 To 158-24-30  
1 X 2 Teeth

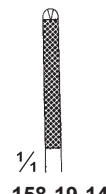

158-19-14  
14 cm / 5 1/2"

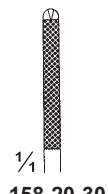

158-20-30  
16 cm / 6 1/4"

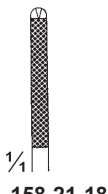

158-21-18  
18 cm / 7"



158-22-20  
20 cm / 8"

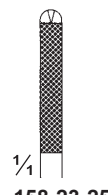

158-23-25  
25 cm / 10"

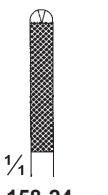

158-24  
30 cm / 12"

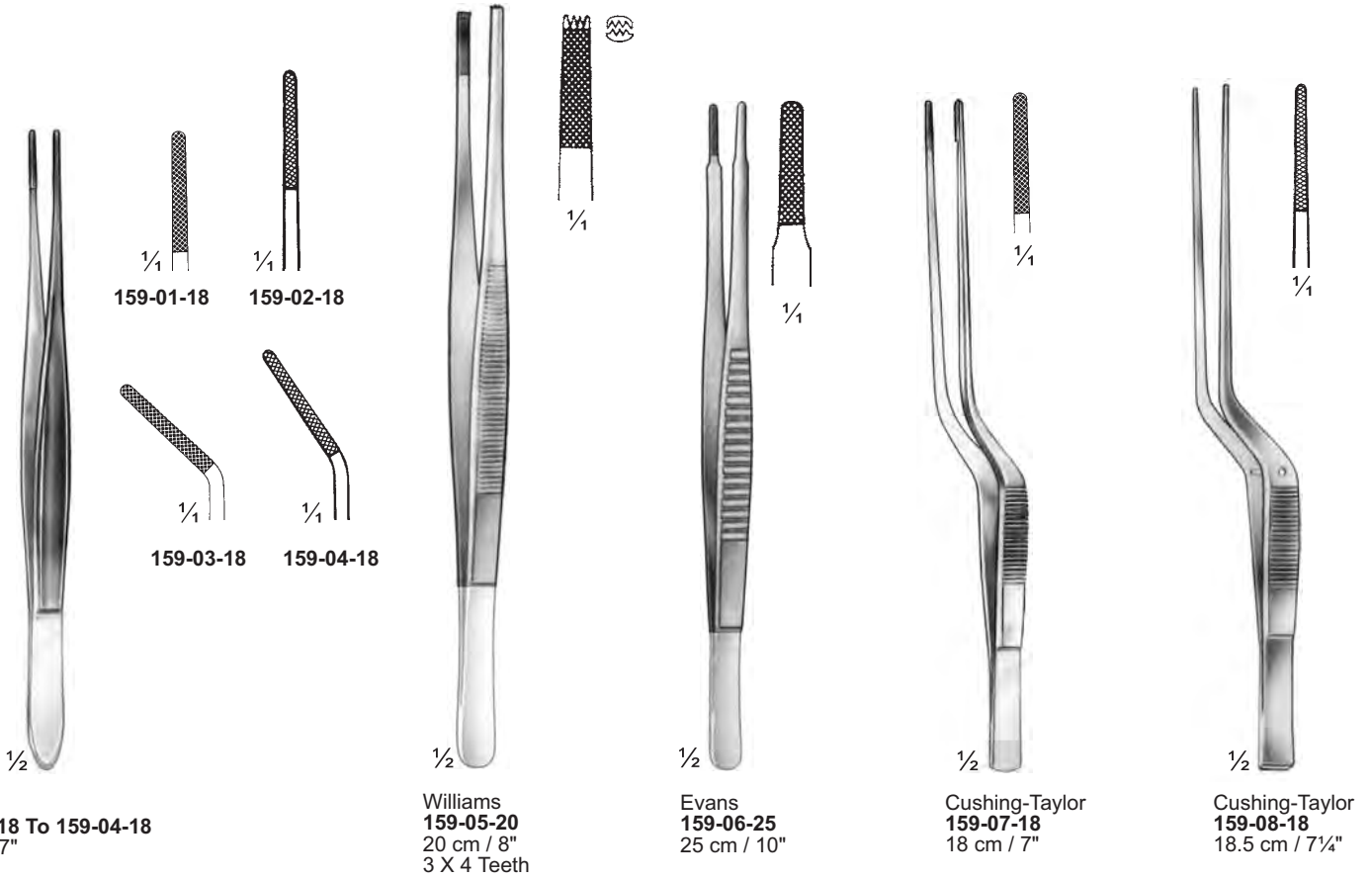

Micro Profile

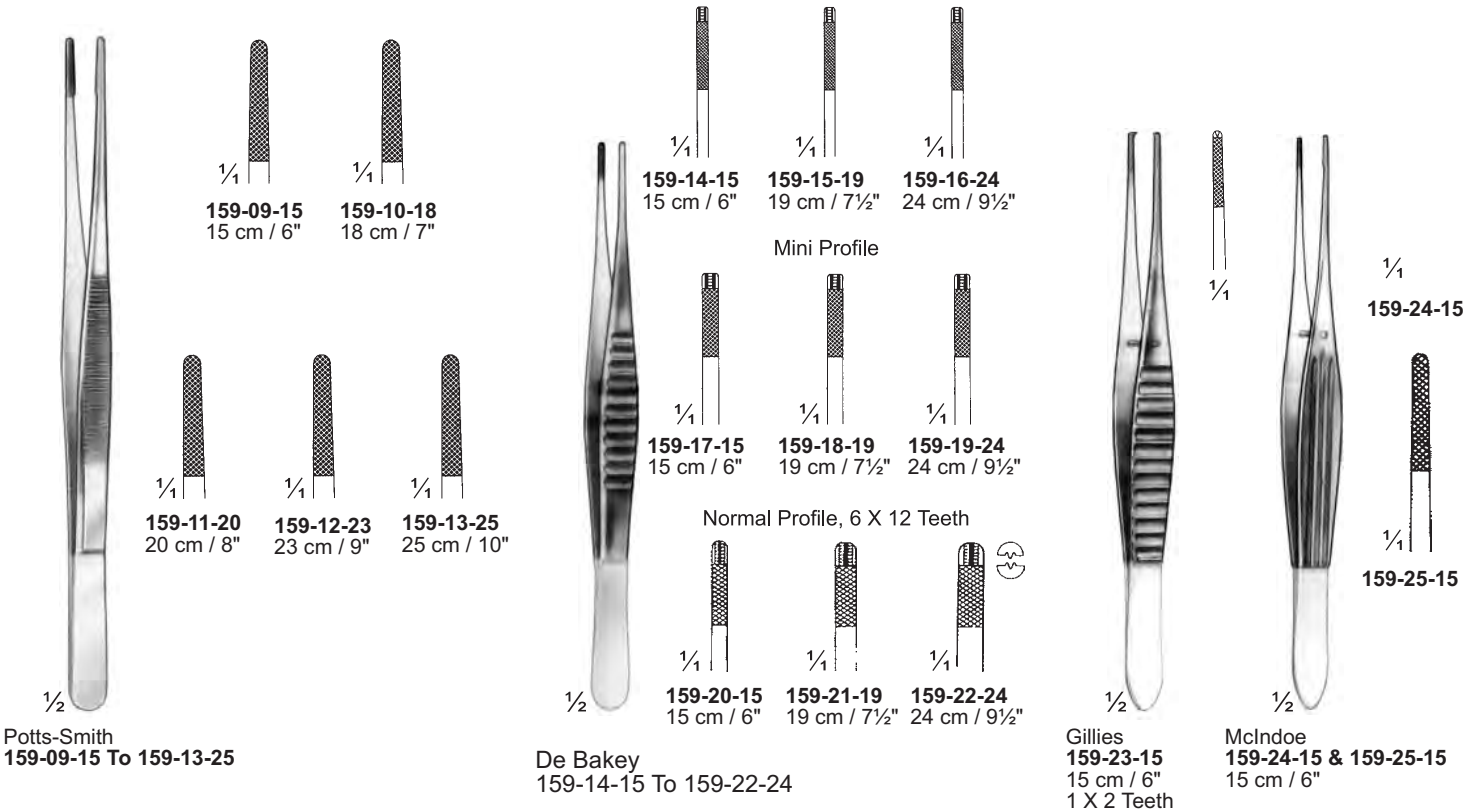

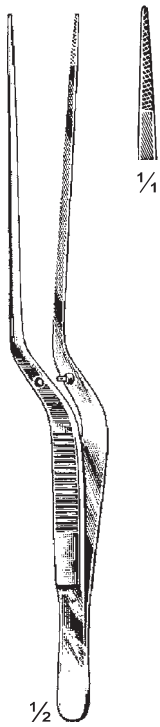

Gruenwald  
**160-01-18**  
 18.5 cm / 7 1/4"

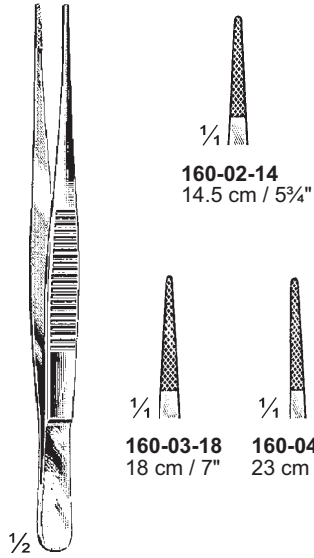

**160-02-14 To 160-04-23**

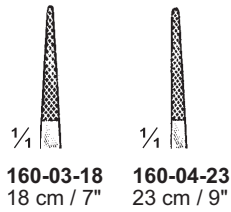

**160-03-18** 18 cm / 7"  
**160-04-23** 23 cm / 9"



Ferris - Smith  
**160-05-17**  
 17 cm / 6 3/4"  
 1 X 2 Teeth



Semken  
**160-06-16 To 160-09-18**  
 1 X 2 Teeth

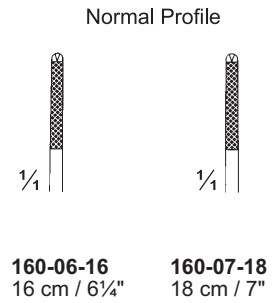

**160-06-16** 16 cm / 6 1/4"  
**160-07-18** 18 cm / 7"

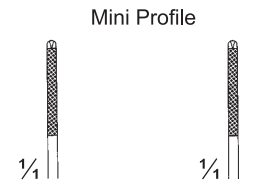

**160-08-16** 16 cm / 6 1/4"  
**160-09-18** 18 cm / 7"

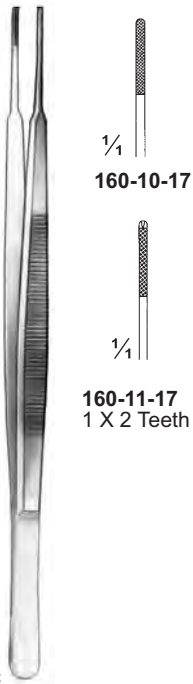

Gerald  
**160-10-17 & 160-11-17**  
 17 cm / 6 3/4"

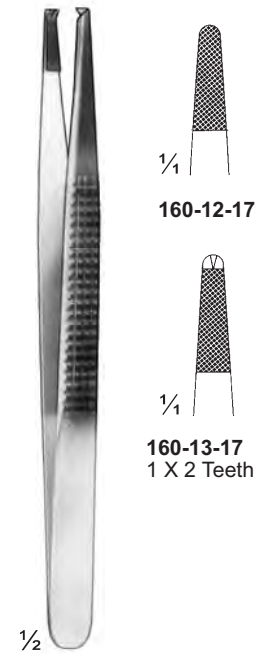

Bonney  
**160-12-17 & 160-13-17**  
 17 cm / 6 3/4"



Skinner  
**160-14-23 To 160-16-23**  
 23 cm / 9"  
 1 X 2 Teeth

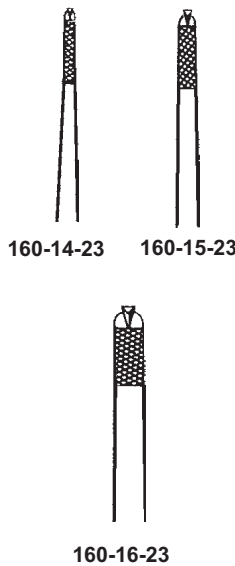

**160-14-23** **160-15-23**

**160-16-23**



Semken  
**160-17-15**  
 15 cm / 6"

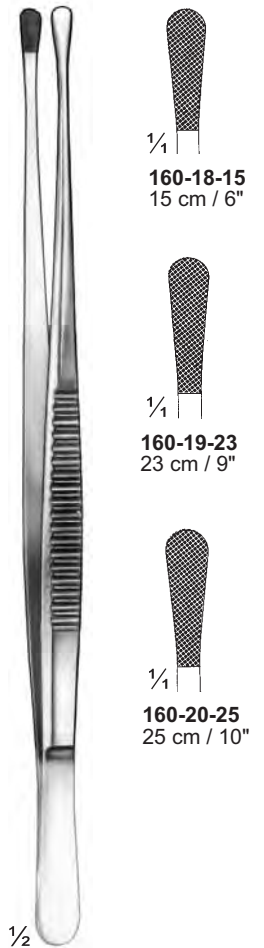

Wangensteen  
**160-18-15 To 160-20-25**

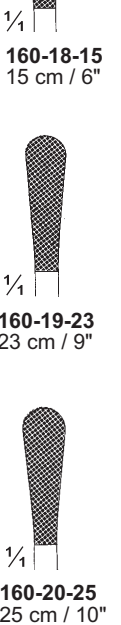

**160-18-15** 15 cm / 6"

**160-19-23** 23 cm / 9"

**160-20-25** 25 cm / 10"



# Arterienklemmen Haemostatic Forceps Pincés hémostatiques

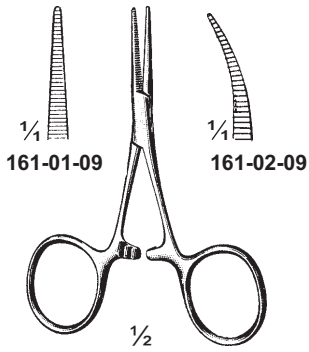

**Micro-Hartmann**  
**161-01-09 & 161-02-09**  
9 cm / 3 1/2"

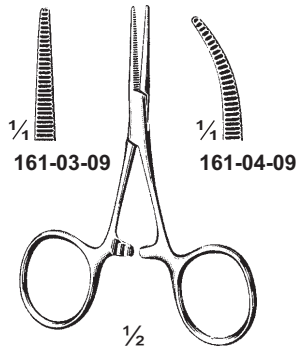

**Hartmann**  
**(Baby Mosquito)**  
**161-03-09 & 161-04-09**  
9 cm / 3 1/2"

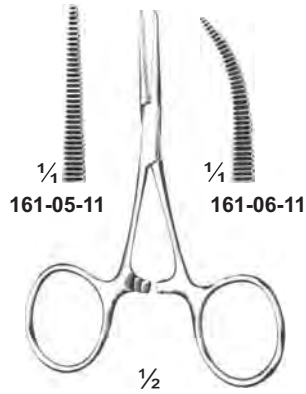

**Carrel (Reynolds)**  
**161-05-11 & 161-06-11**  
11 cm / 4 1/4"

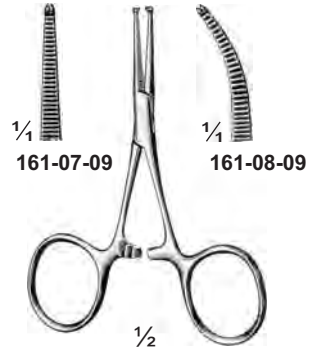

**Hartmann**  
**(Baby-Mosquito)**  
**161-07-09 & 161-08-09**  
9 cm / 3 1/2"  
1 X 2 Teeth

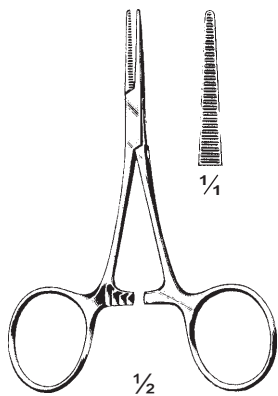

**Hartmann**  
**161-09-10**  
10 cm / 4"

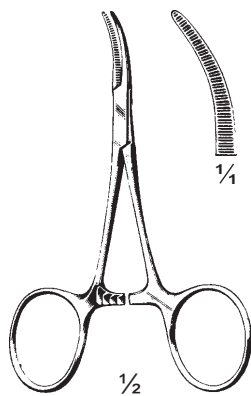

**Hartmann**  
**161-10-10**  
10 cm / 4"



**Hartmann**  
**161-11-10**  
10 cm / 4"  
1 X 2 Teeth

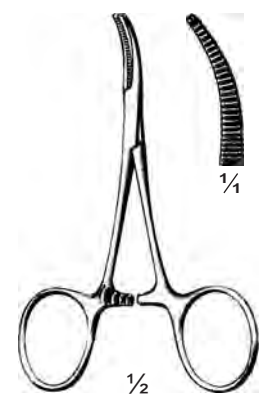

**Hartmann**  
**161-12-10**  
10 cm / 4"  
1 X 2 Teeth

# Arterienklemmen Haemostatic Forceps Pincès hémostatiques

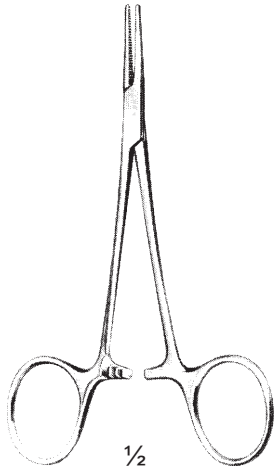

Halstead-Mosquito  
162-01-12 To 162-08-14

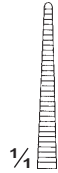

162-01-12  
12.5 cm / 5"



162-02-14  
14 cm / 5½"



162-03-12  
12.5 cm / 5"  
1 X 2 Teeth

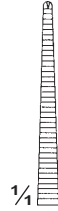

162-04-14  
14 cm / 5½"  
1 X 2 Teeth



162-05-12  
12.5 cm / 5"

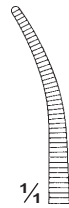

162-06-14  
14 cm / 5½"

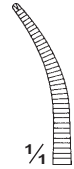

162-07-12  
12.5 cm / 5"  
1 X 2 Teeth

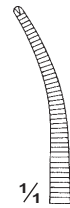

162-08-14  
14 cm / 5½"  
1 X 2 Teeth

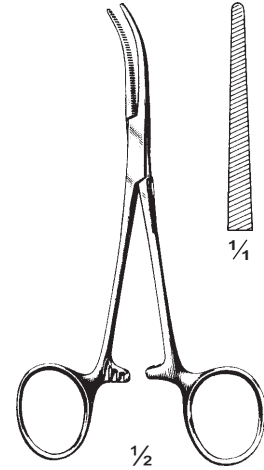

Mosquito-Dandy  
162-09-12  
12.5 cm / 5"

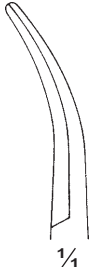
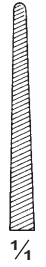

Micro-Halstead  
162-10-10 To 162-17-12



162-10-10  
10 cm / 4"



162-11-12  
12.5 cm / 5"



162-12-10  
10 cm / 4"  
1 X 2 Teeth



162-13-12  
12.5 cm / 5"  
1 X 2 Teeth



162-14-10  
10 cm / 4"



162-15-12  
12.5 cm / 5"



162-16-10  
10 cm / 4"  
1 X 2 Teeth



162-17-12  
12.5 cm / 5"  
1 X 2 Teeth

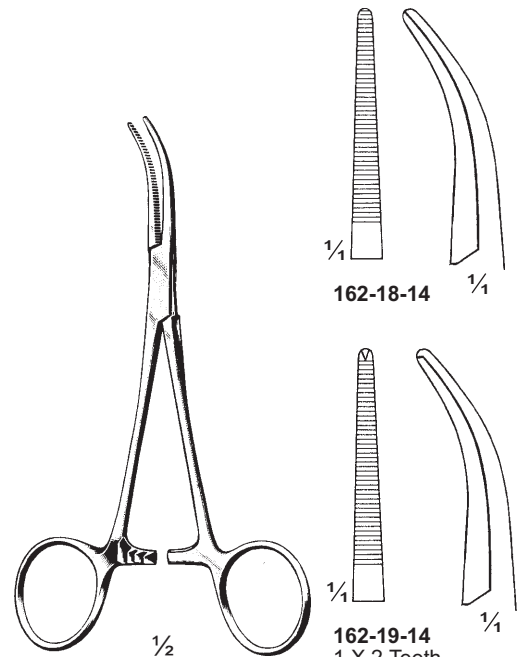

Dandy  
162-18-14 & 162-19-14  
14 cm / 5½"



162-18-14



162-19-14  
1 X 2 Teeth

# Arterienklemmen Haemostatic Forceps Pincés hémostatiques

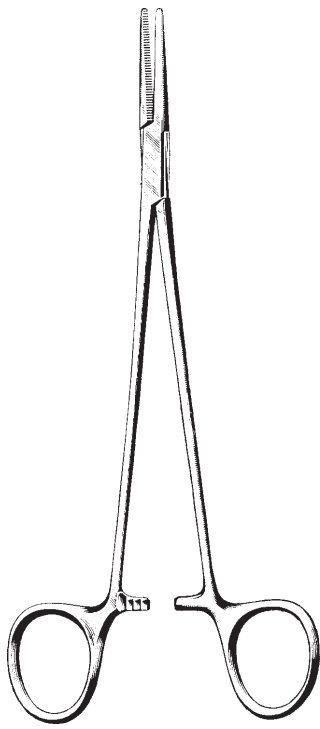

Halstead-Mosquito  
163-01-18 To 163-08-21



163-01-18  
18 cm / 7"

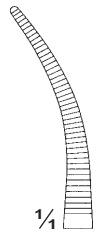

163-02-18  
18 cm / 7"



163-03-18  
18 cm / 7"  
1 X 2 Teeth

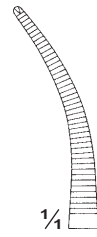

163-04-18  
18 cm / 7"  
1 X 2 Teeth



163-05-21  
21 cm / 8 1/4"

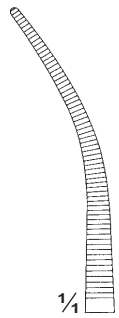

163-06-21  
21 cm / 8 1/4"



163-07-21  
21 cm / 8 1/4"  
1 X 2 Teeth

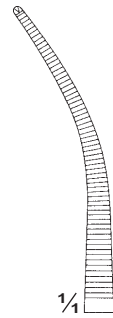

163-08-21  
21 cm / 8 1/4"  
1 X 2 Teeth

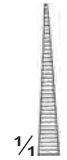

163-09-12



163-10-12

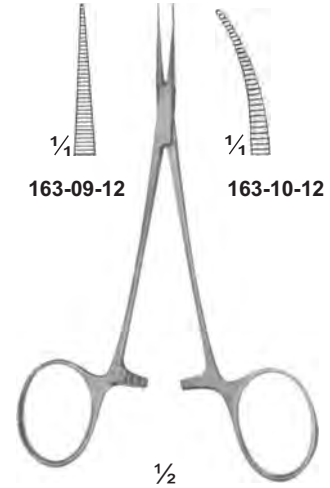

Jacobson-Micro  
163-09-12 & 163-10-12  
12.5 cm / 5"

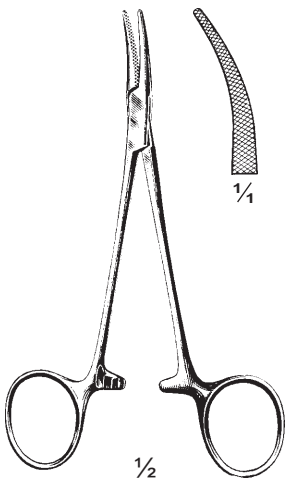

163-11-12  
12.5 cm / 5"



163-12-14



163-13-14

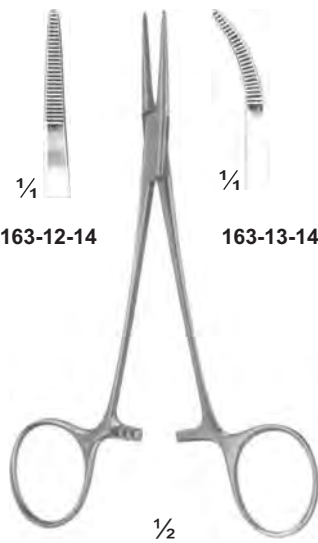

Providence-Hospital  
163-12-14 & 163-13-14  
14 cm / 5 1/2"



163-14-14



163-15-14

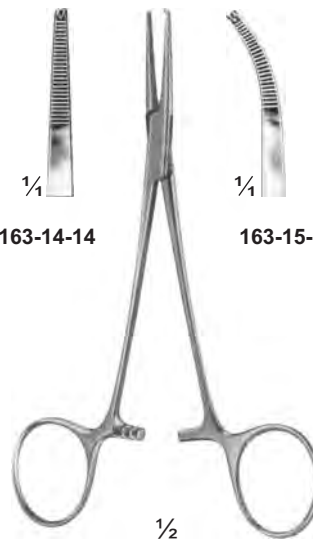

Providence-Hospital  
163-14-14 & 163-15-14  
14 cm / 5 1/2"  
1 X 2 Teeth



163-16-12



163-17-12

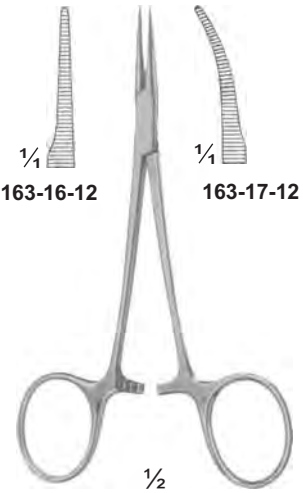

Skillman  
163-16 & 163-17  
12.5 cm / 5"

# Arterienklemmen Haemostatic Forceps Pincés hémostatiques

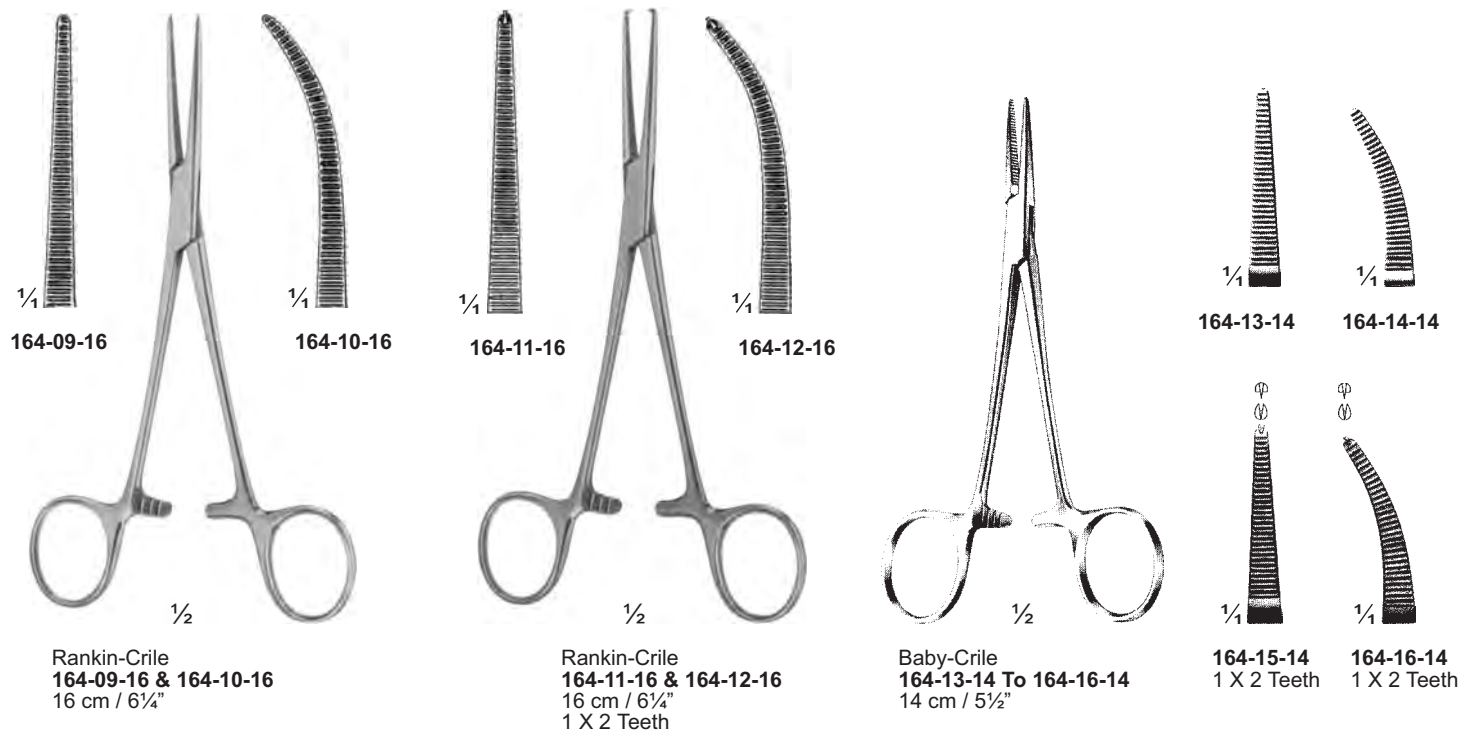
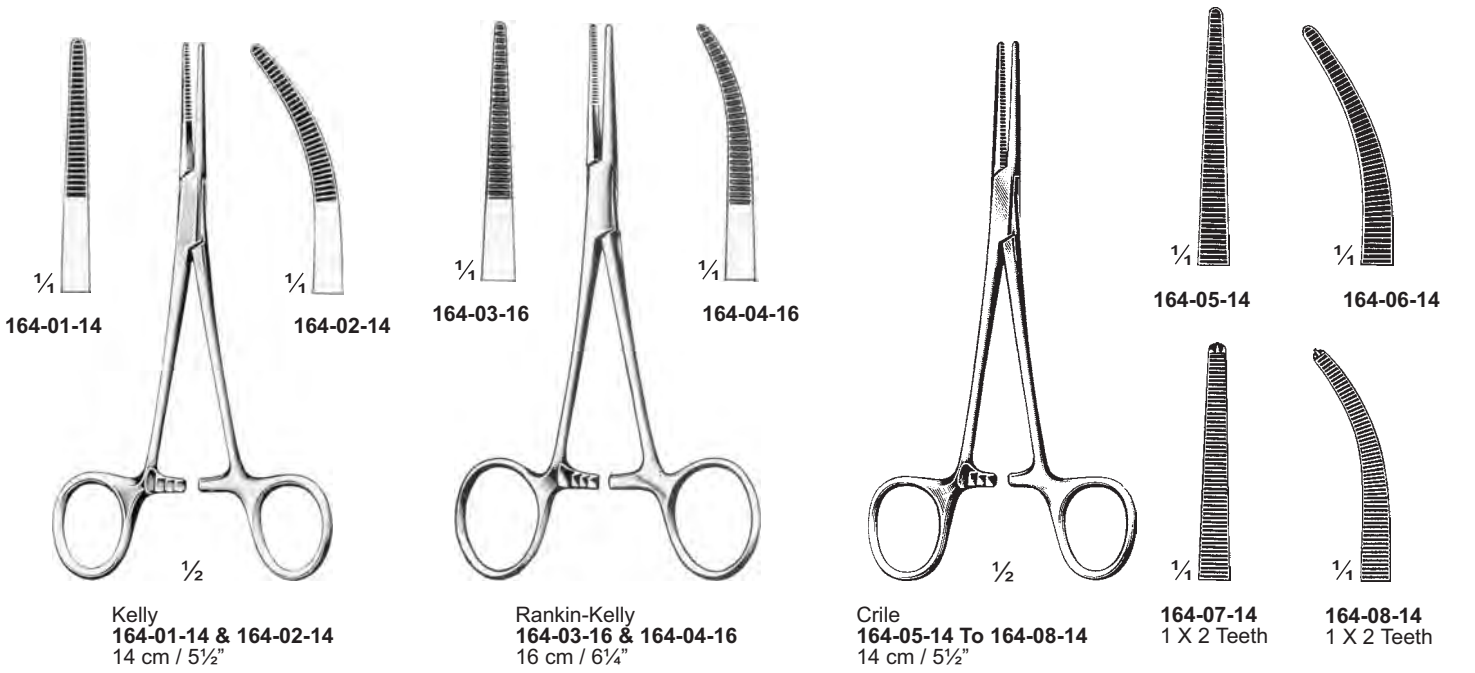

# Arterienklemmen Haemostatic Forceps Pincés hémostatiques

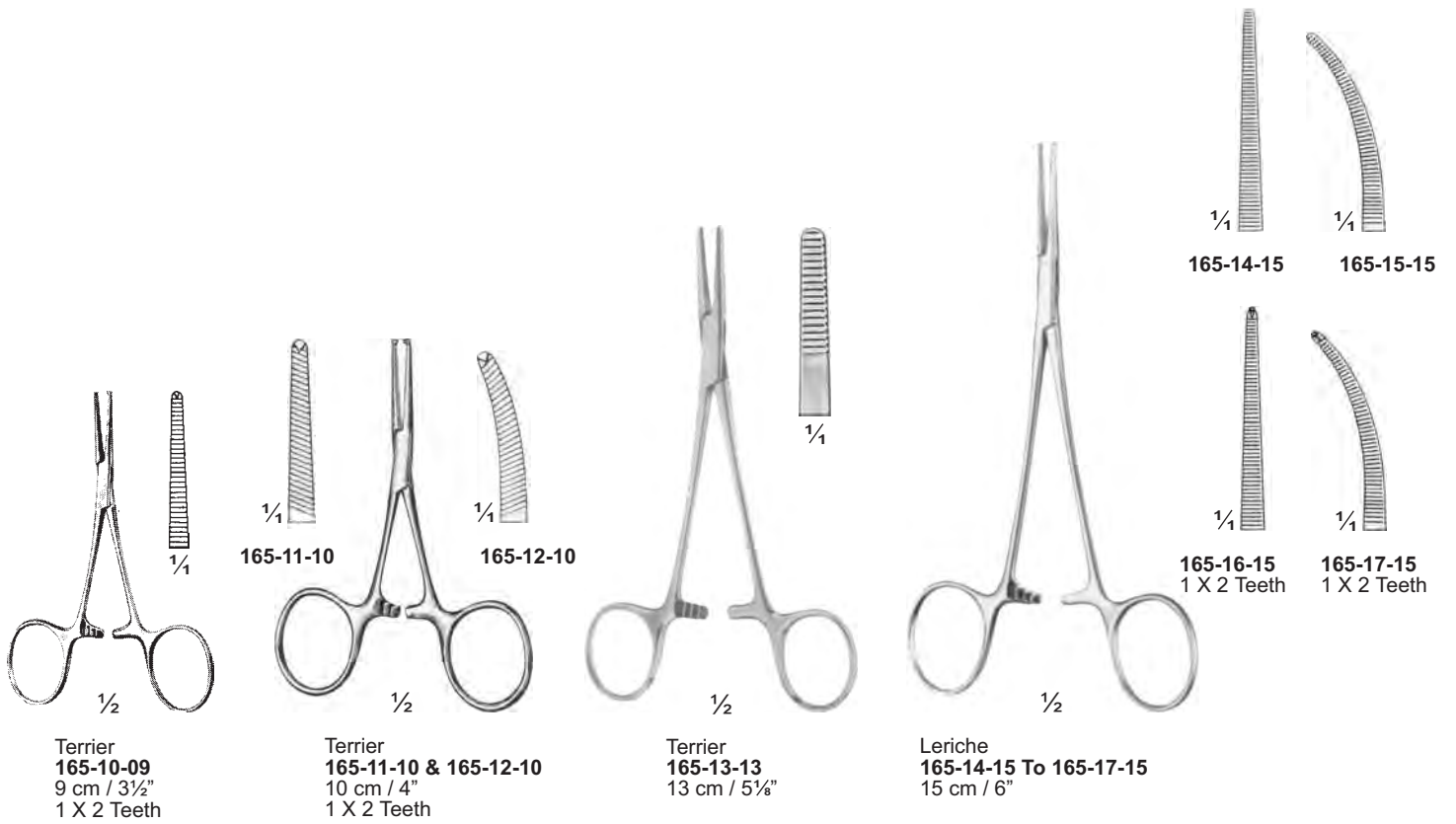
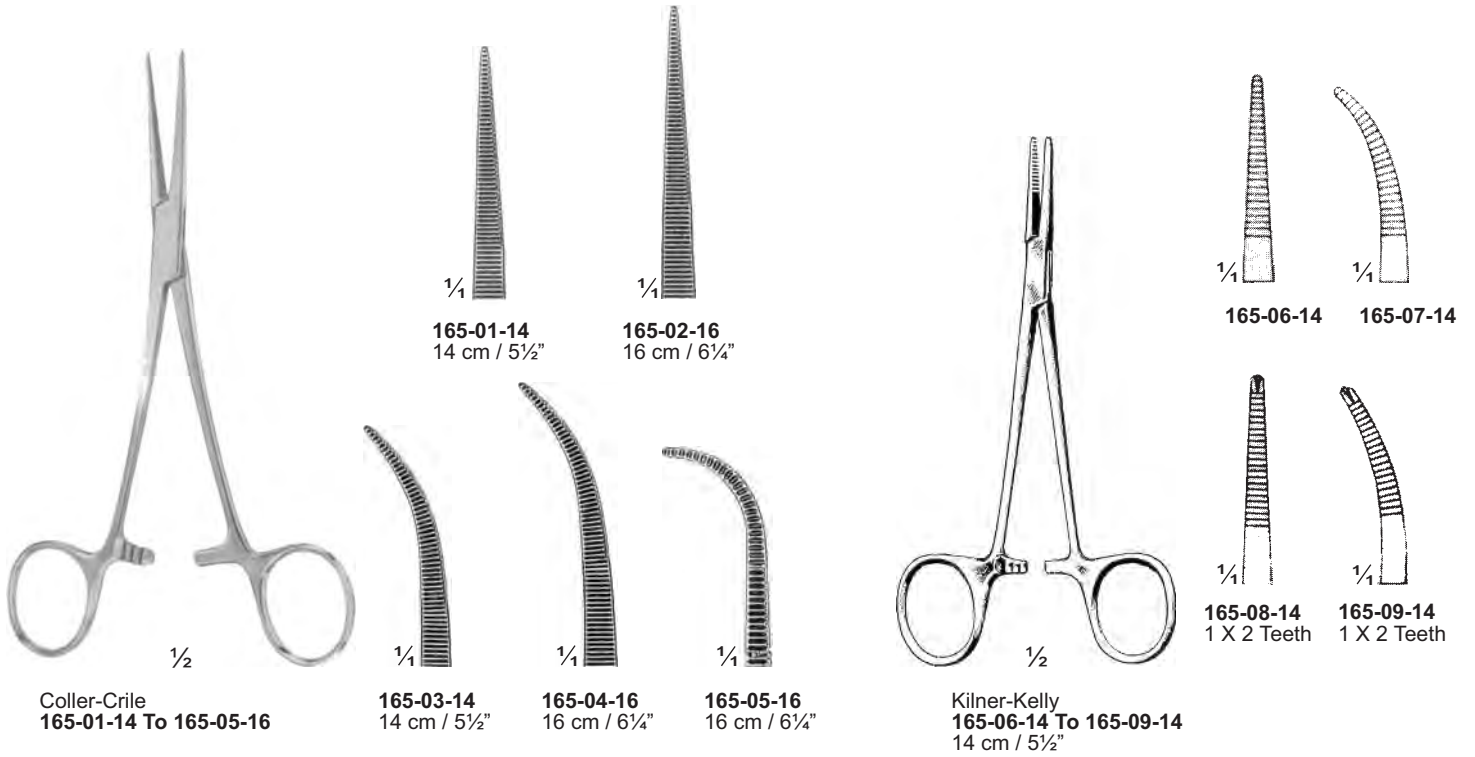

# Arterienklemmen Haemostatic Forceps Pincés hémostatiques

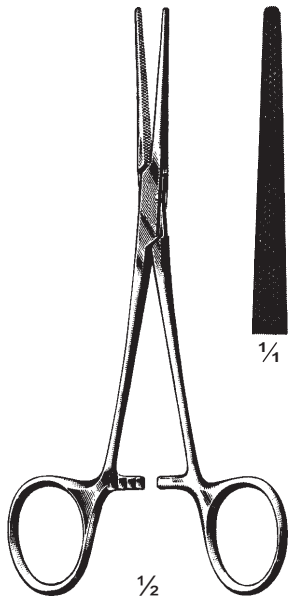

Dixon-Lovelace  
**166-01-16**  
16 cm / 6¼"

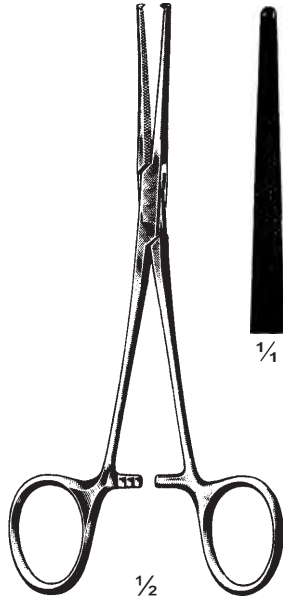

Dixon-Lovelace  
**166-02-16**  
16 cm / 6¼"  
1 X 2 Teeth

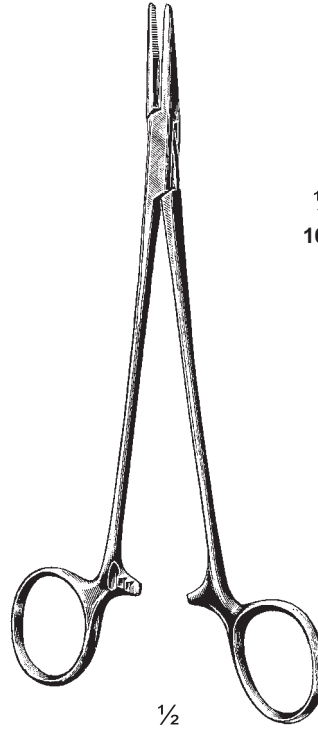

Adson  
**166-03-18 & 166-04-18**  
18.5 cm / 7¼"

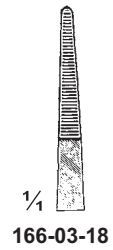

1/4  
**166-03-18**

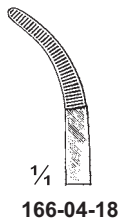

1/4  
**166-04-18**

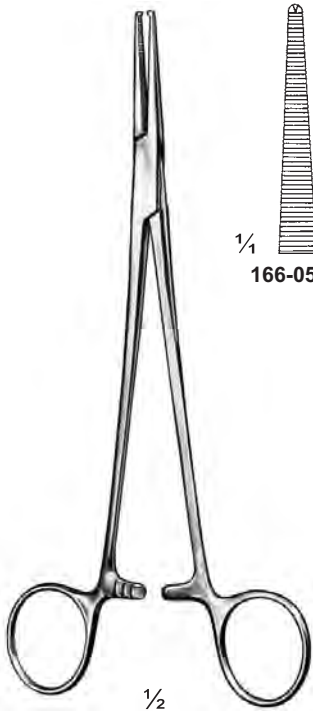

Adson  
**166-05-18 & 166-06-18**  
18.5 cm / 7¼"  
1 X 2 Teeth

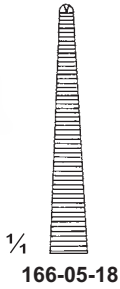

1/4  
**166-05-18**

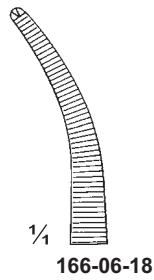

1/4  
**166-06-18**

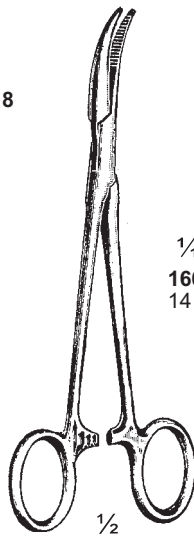

Moynihan  
**166-07-14 & 166-08-14**

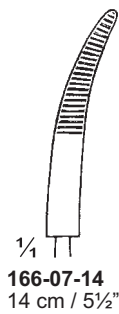

1/4  
**166-07-14**  
14 cm / 5½"

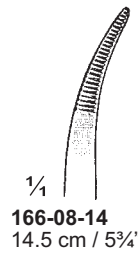

1/4  
**166-08-14**  
14.5 cm / 5¾"



1/4  
**166-09-23**  
23 cm / 9"



1/4  
**166-10-24**  
24 cm / 9½"

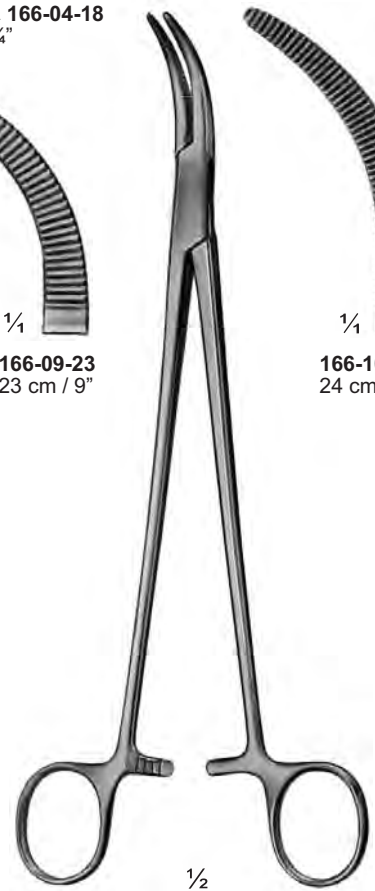

Moynihan  
**166-09-23 & 166-10-24**



# Arterienklemmen Haemostatic Forceps Pincès hémostatiques



$\frac{1}{2}$   
Bengolea  
167-01-20 To 167-12-26

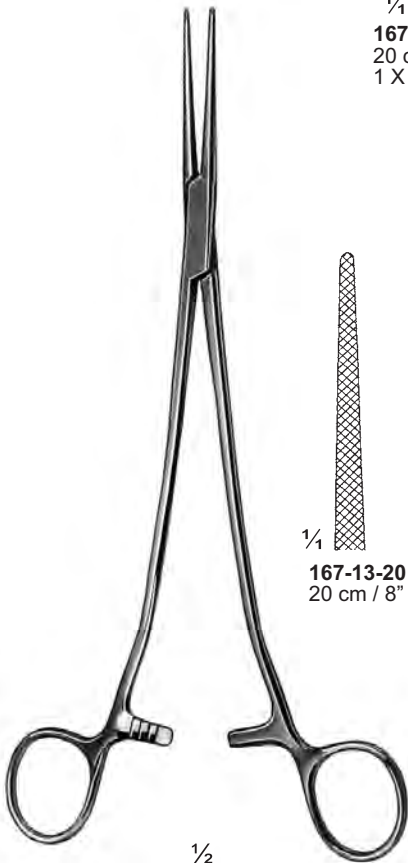
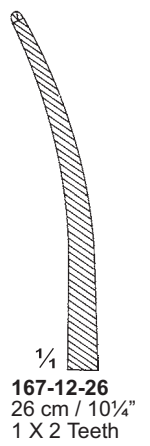
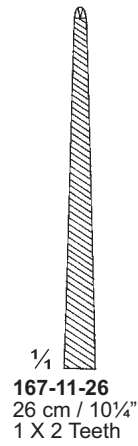
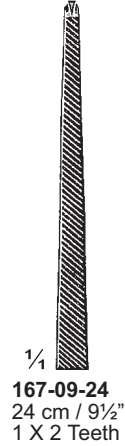
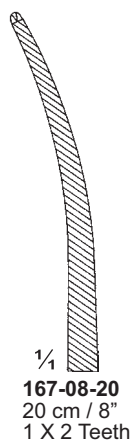
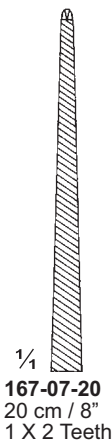
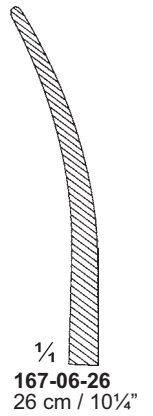
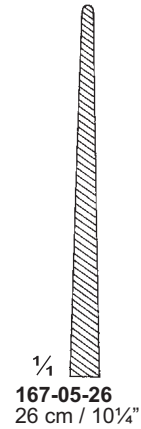
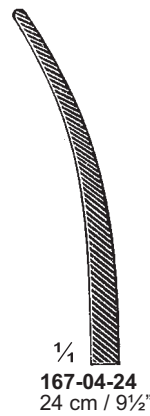
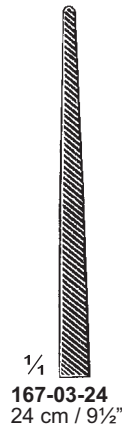
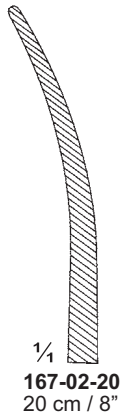
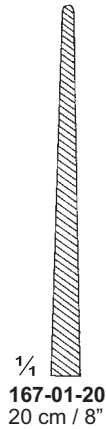

$\frac{1}{2}$   
Bengolea  
167-13-20 To 167-20-23

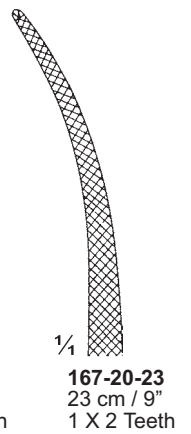
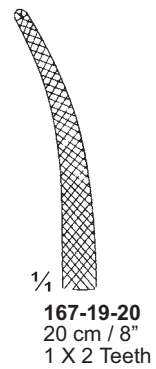
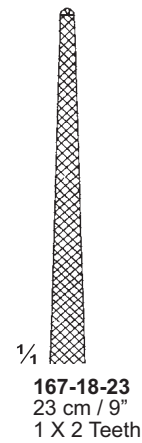
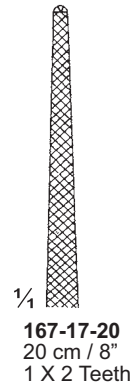
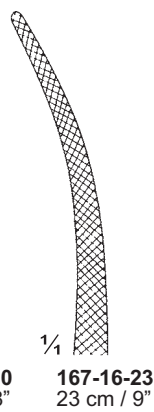
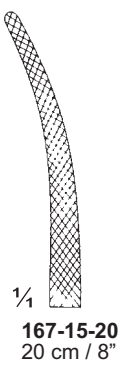
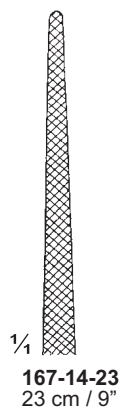
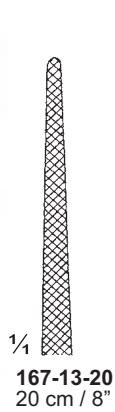

# Arterienklemmen Haemostatic Forceps Pincés hémostatiques



Rochester-Pean  
168-01-12 To 168-09-30

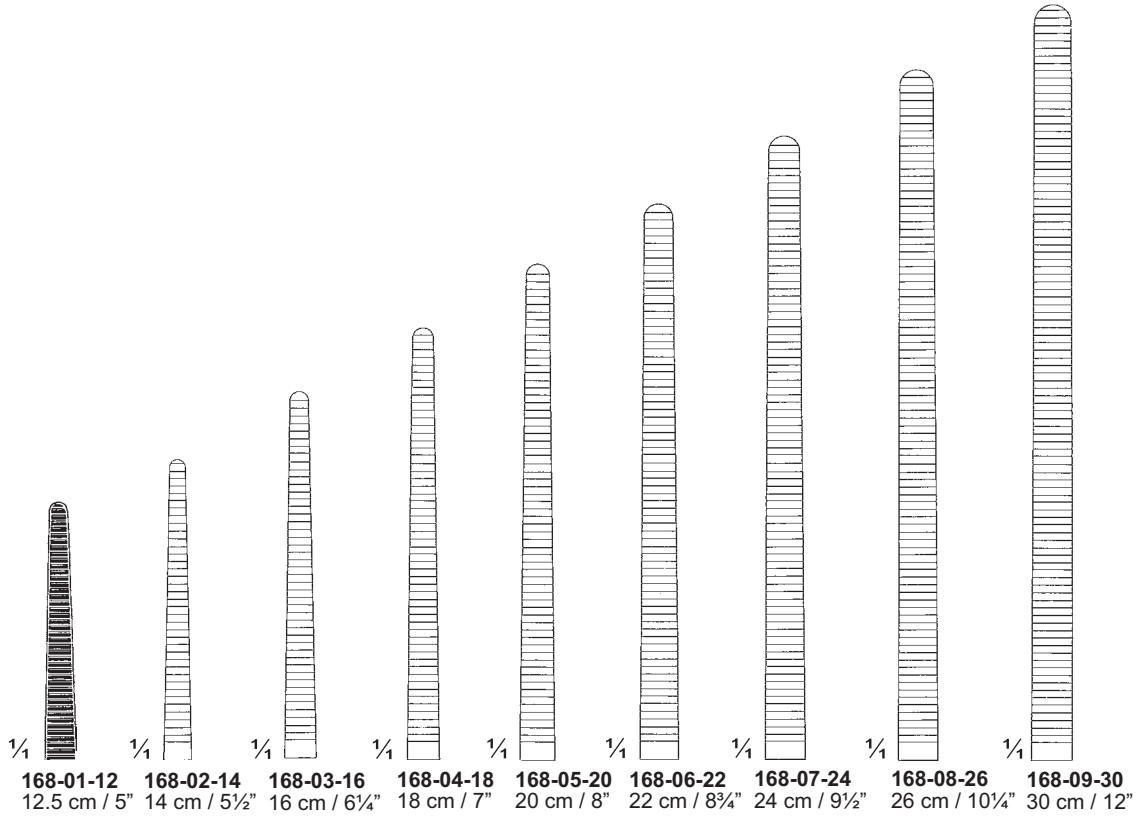

Rochester-Pean  
168-10-12 To 168-18-30

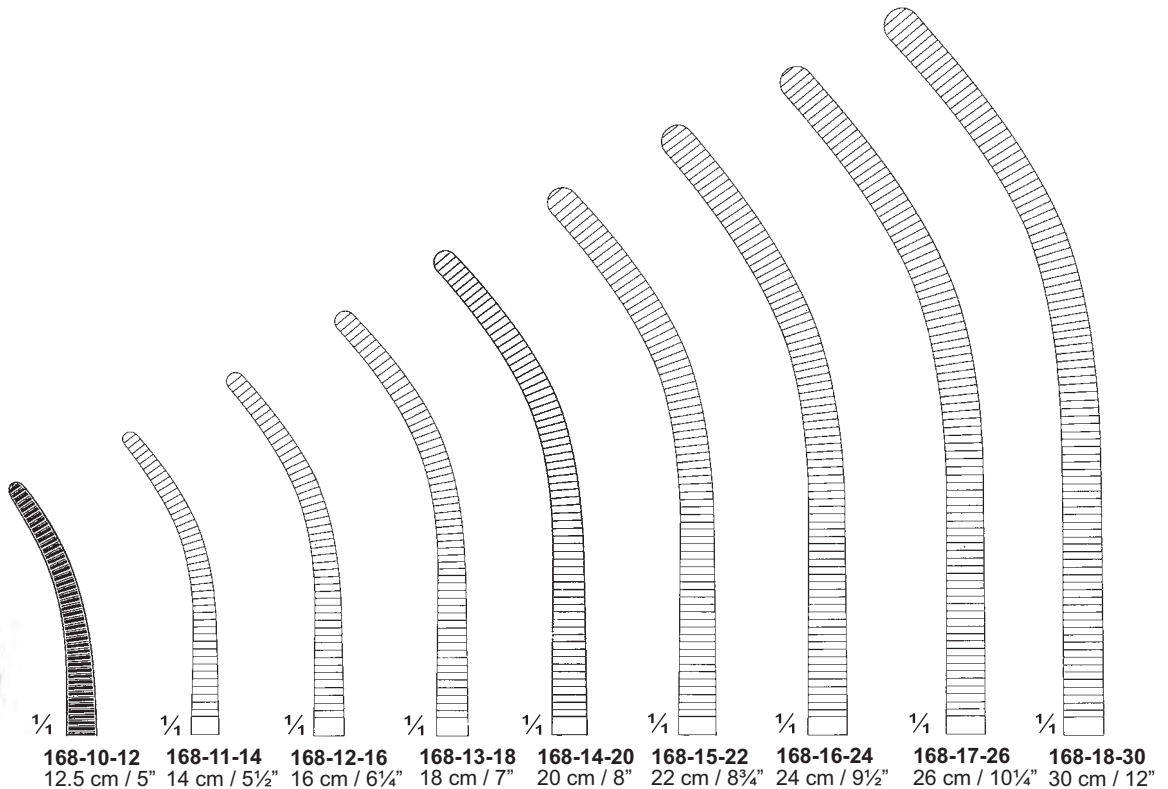

# Arterienklemmen Haemostatic Forceps Pincès hémostatiques

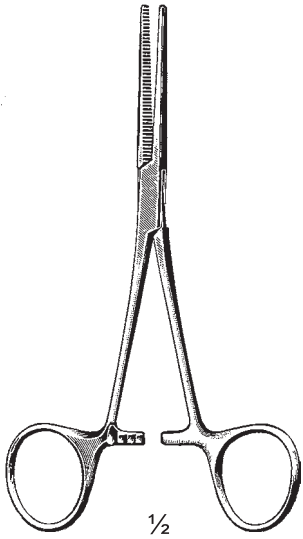

Pean  
169-01-12 To 169-06-16

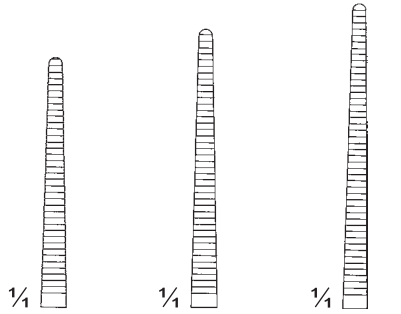

169-01-12 12.5 cm / 5"  
169-02-14 14 cm / 5 1/2"  
169-03-16 16 cm / 6 1/4"

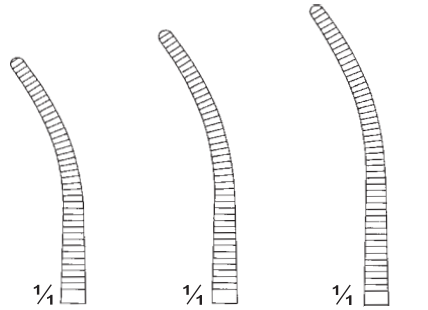

169-04-12 12.5 cm / 5"  
169-05-14 14 cm / 5 1/2"  
169-06-16 16 cm / 6 1/4"

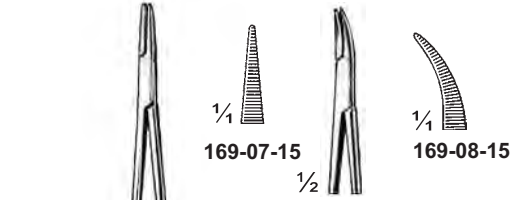

169-07-15 & 169-08-15  
15 cm / 6"

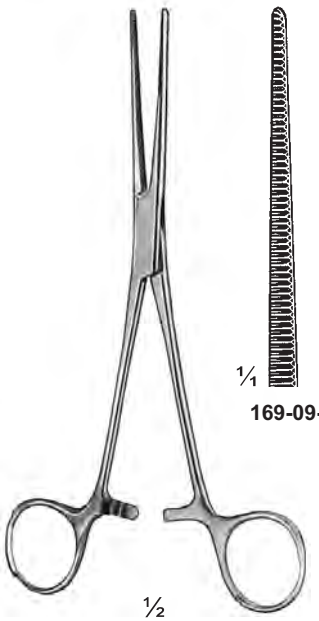

Pean-Dixon  
169-09-16 & 169-10-16  
16 cm / 6 1/4"

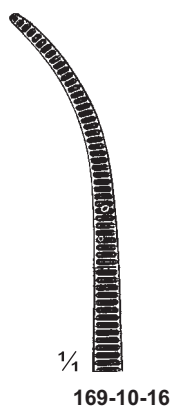

169-09-16

169-10-16

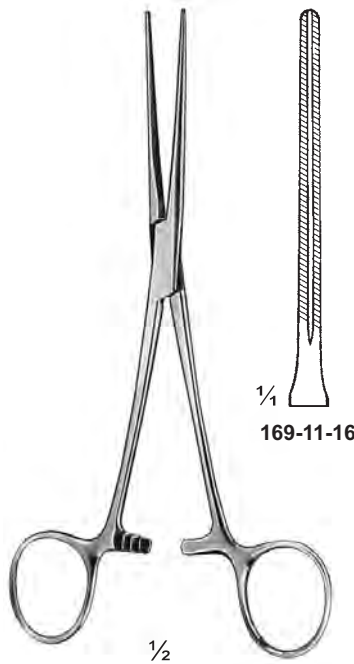

Bainbridge-Glassman  
169-11-16 & 169-12-16  
16.5 cm / 6 1/2"

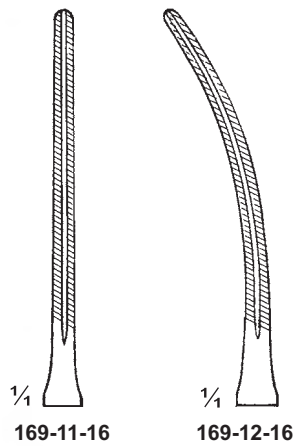

169-11-16

169-12-16

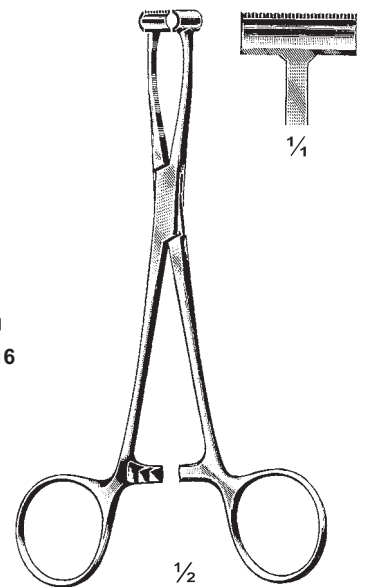

Pratt  
169-13-15  
15 cm / 6"

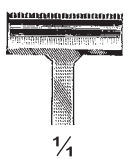

1/4

# Arterienklemmen Haemostatic Forceps Pincers hémostatiques



Pean-Nippon  
170-01-14 To 170-06-18

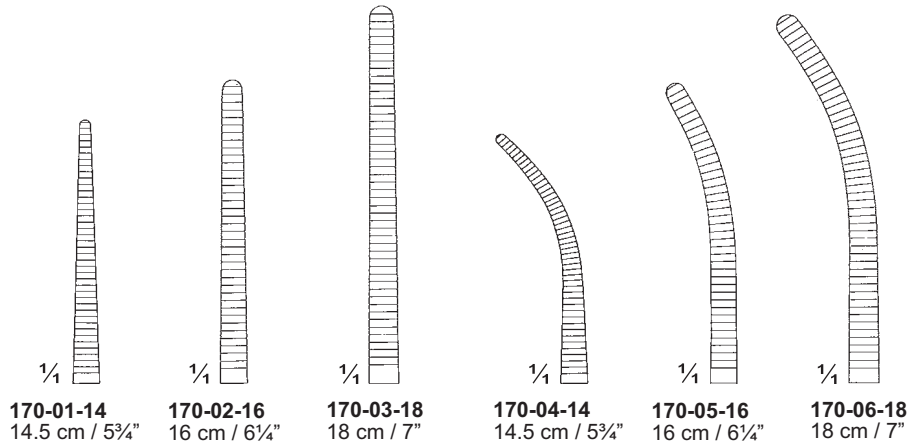

170-01-14  
14.5 cm / 5 3/4"

170-02-16  
16 cm / 6 1/4"

170-03-18  
18 cm / 7"

170-04-14  
14.5 cm / 5 3/4"

170-05-16  
16 cm / 6 1/4"

170-06-18  
18 cm / 7"

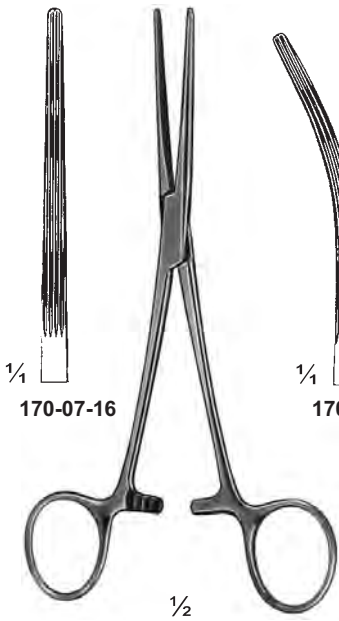

Bainbridge-Baby  
170-07-16 & 170-08-16  
16 cm / 6 1/4"

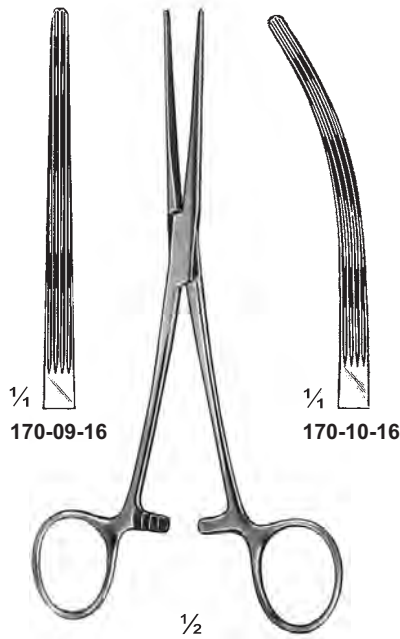

Bainbridge  
170-09-16 & 170-10-16  
16.5 cm / 6 1/2"

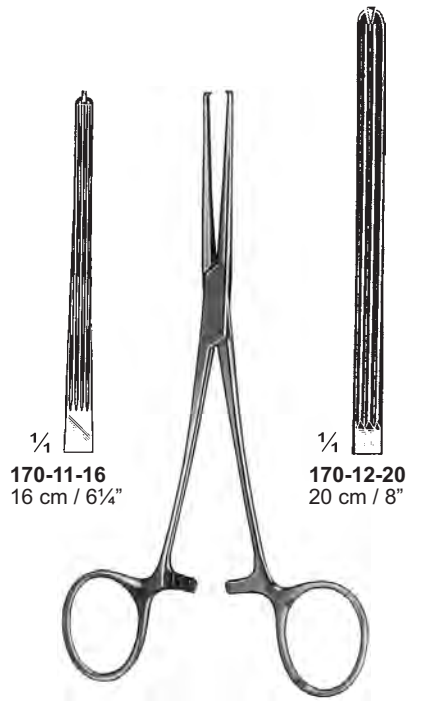

Allen-Kocher  
170-11-16 & 170-12-20  
1 X 2 Teeth

**Arterienklemmen ; Pinzas hemostáticas  
Haemostatic Forceps ; Pinze emostatica  
Pinces hémostatiques ; Pinça hemostatica**

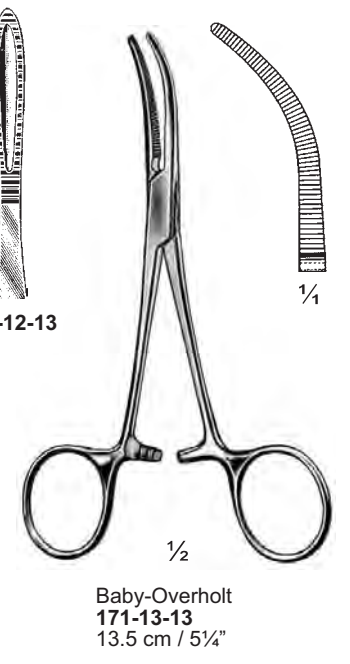
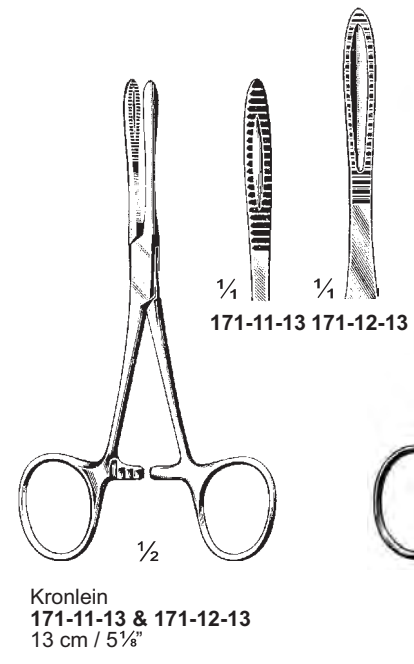
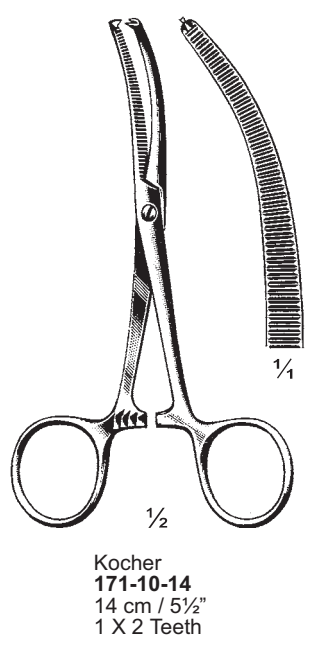
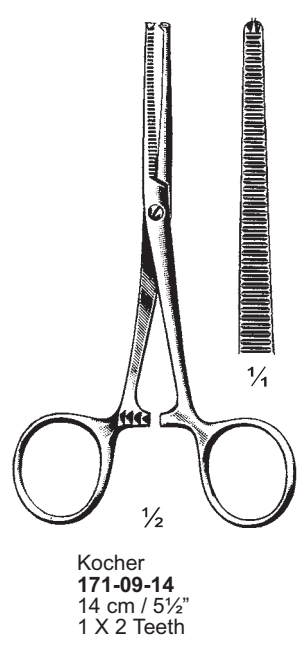
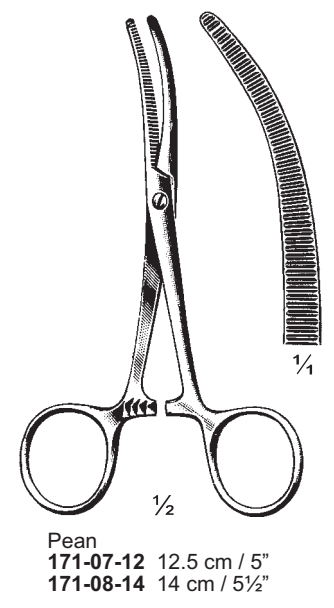
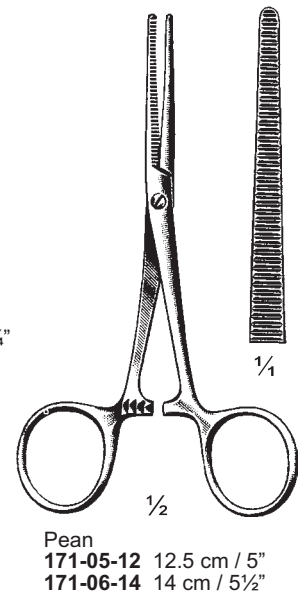
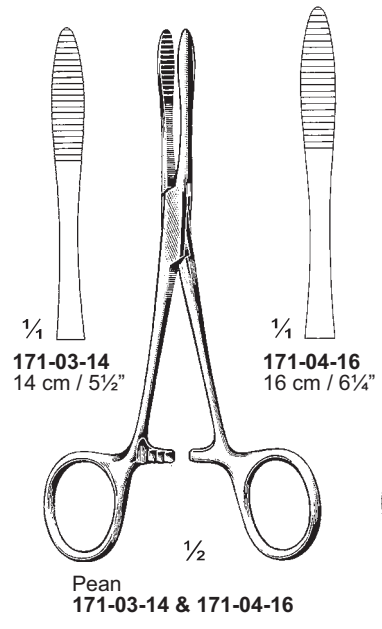
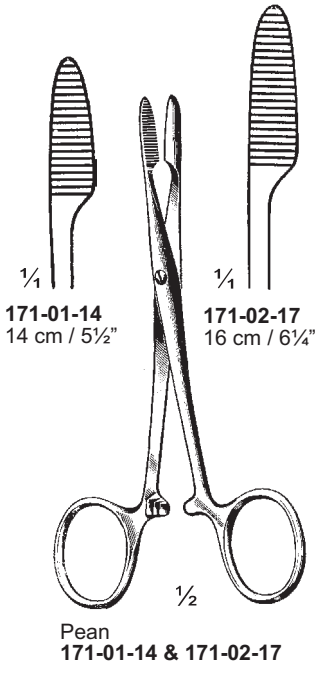

**Arterienklemmen ; Pinzas hemostáticas  
Haemostatic Forceps ; Pinze emostatica  
Pinces hémostatiques ; Pinça hemostatica**

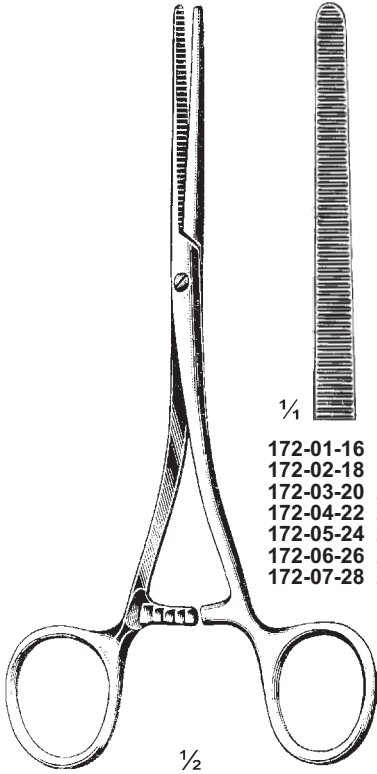

1/4

1/4

- |           |                 |           |
|-----------|-----------------|-----------|
| 172-01-16 | 16 cm / 6 1/4"  | 172-08-16 |
| 172-02-18 | 18 cm / 7"      | 172-09-18 |
| 172-03-20 | 20 cm / 8"      | 172-10-20 |
| 172-04-22 | 22 cm / 8 3/4"  | 172-11-22 |
| 172-05-24 | 24 cm / 9 1/2"  | 172-12-24 |
| 172-06-26 | 26 cm / 10 1/4" | 172-13-26 |
| 172-07-28 | 28 cm / 11"     | 172-14-28 |

1/2

Pean  
172-01-16 To 172-14-28

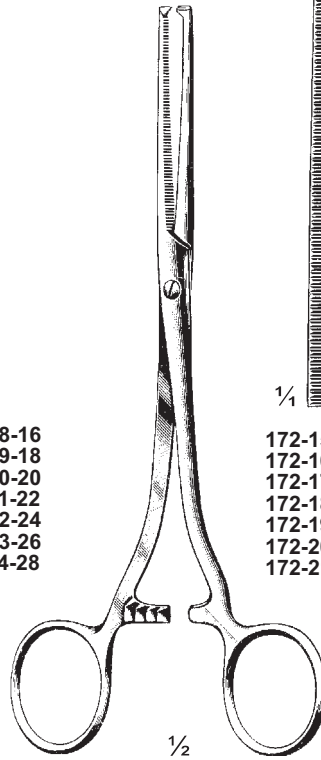

1/4

1/4

- |           |                 |           |
|-----------|-----------------|-----------|
| 172-15-16 | 16 cm / 6 1/4"  | 172-22-16 |
| 172-16-18 | 18 cm / 7"      | 172-23-18 |
| 172-17-20 | 20 cm / 8"      | 172-24-20 |
| 172-18-22 | 22 cm / 8 3/4"  | 172-25-22 |
| 172-19-24 | 24 cm / 9 1/2"  | 172-26-24 |
| 172-20-26 | 26 cm / 10 1/4" | 172-27-26 |
| 172-21-28 | 28 cm / 11"     | 172-28-28 |

1/2

Kocher  
172-15-16 To 172-28-28  
1 X 2 Teeth

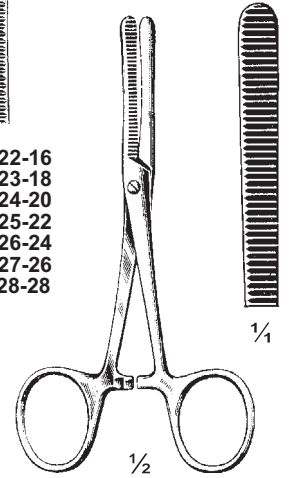

1/4

1/2

Pean  
172-29-12 12.5 cm / 5"  
172-30-16 16 cm / 6 1/4"

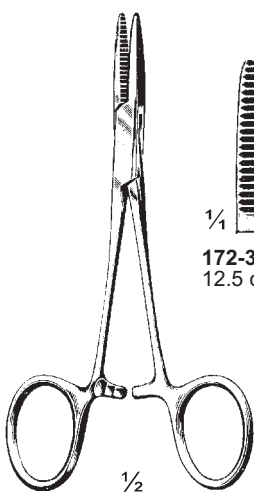

1/4

1/4

- |           |              |            |
|-----------|--------------|------------|
| 172-31-12 | 12.5 cm / 5" | 172-32-15  |
|           |              | 15 cm / 6" |

1/2

Jones (Spencer-Wells)  
172-31-12 & 172-32-15

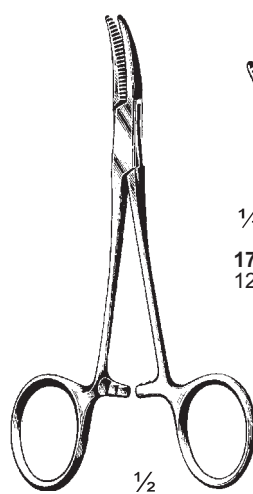

1/4

1/4

- |           |              |            |
|-----------|--------------|------------|
| 172-33-12 | 12.5 cm / 5" | 172-34-15  |
|           |              | 15 cm / 6" |

1/2

Jones (Spencer-Wells)  
172-33-12 & 172-34-15

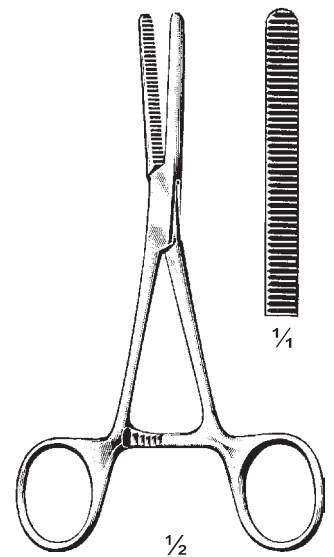

1/4

1/2

Mod. Klinikum Berlin  
172-35-14 14.5 cm / 5 3/4"  
172-36-16 16 cm / 6 1/4"



Arterienklemmen ; Pinzas hemostáticas  
 Haemostatic Forceps ; Pinze emostatica  
 Pinces hémostatiques ; Pinça hemostatica



$\frac{1}{2}$   
 Spencer-Wells  
 173-01-13 To 173-10-20



$\frac{1}{4}$   
 173-01-13  
 13 cm / 5  $\frac{1}{8}$ "



$\frac{1}{4}$   
 173-02-14  
 14 cm / 5  $\frac{1}{2}$ "



$\frac{1}{4}$   
 173-03-15  
 15 cm / 6"



$\frac{1}{4}$   
 173-04-18  
 18 cm / 7"

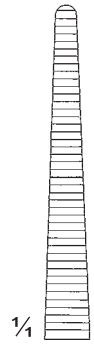

$\frac{1}{4}$   
 173-05-20  
 20 cm / 8"



$\frac{1}{4}$   
 173-06-13  
 13 cm / 5  $\frac{1}{8}$ "

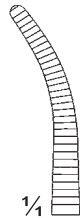

$\frac{1}{4}$   
 173-07-14  
 14 cm / 5  $\frac{1}{2}$ "

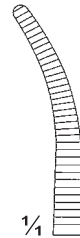

$\frac{1}{4}$   
 173-08-15  
 15 cm / 6"

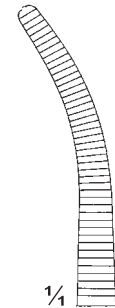

$\frac{1}{4}$   
 173-09-18  
 18 cm / 7"

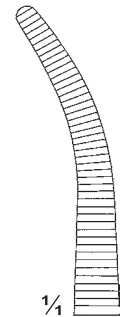

$\frac{1}{4}$   
 173-10-20  
 20 cm / 8"

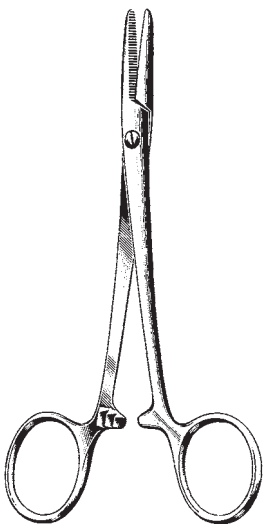

Spencer-Wells  
 173-11-15 To 173-13-20



$\frac{1}{4}$   
 173-11-15  
 15 cm / 6"



$\frac{1}{4}$   
 173-12-18  
 18 cm / 7"



$\frac{1}{4}$   
 173-13-20  
 20 cm / 8"

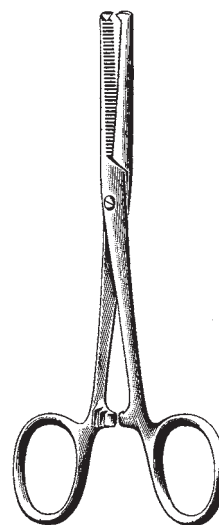

Kocher  
 173-14-15 To 173-16-20  
 1 X 2 Teeth



$\frac{1}{4}$   
 173-14-15  
 15 cm / 6"



$\frac{1}{4}$   
 173-15-18  
 18 cm / 7"



$\frac{1}{4}$   
 173-16-20  
 20 cm / 8"

**Arterienklemmen ; Pinzas hemostáticas  
Haemostatic Forceps ; Pinze emostatica  
Pinces hémostatiques ; Pinça hemostatica**

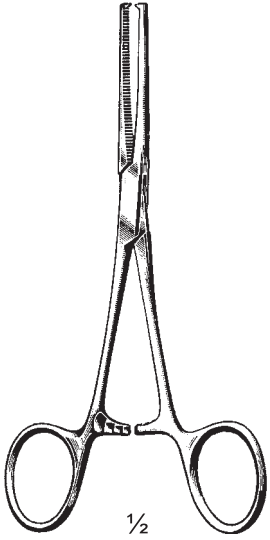

**Kocher (Ochsner)**  
174-01-20 TO 174-08-30  
1 X 2 Teeth



**174-01-14**  
14 cm / 5½"



**174-02-16**  
16 cm / 6¼"



**174-03-18**  
18 cm / 7"



**174-04-20**  
20 cm / 8"



**174-05-22**  
22 cm / 8¾"



**174-06-24**  
24 cm / 9½"



**174-07-26**  
26 cm / 10¼"



**174-08-30**  
30 cm / 12"



**174-09-16**  
16 cm / 6¼"



**174-10-20**  
20 cm / 8"



**174-11-23**  
23 cm / 9"

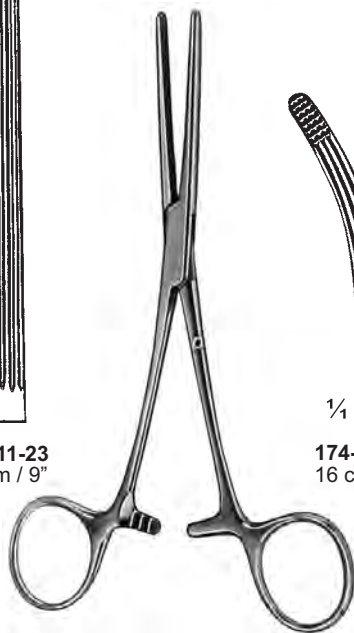

**Rochester-Carmalt**  
174-09-16 To 174-14-23



**174-12-16**  
16 cm / 6¼"



**174-13-20**  
20 cm / 8"



**174-14-23**  
23 cm / 9"



**174-15-22**

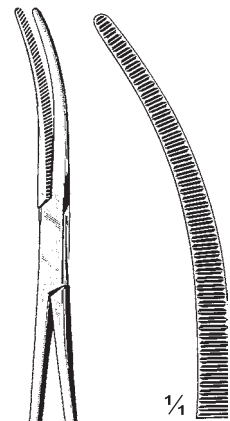

**174-16-22**

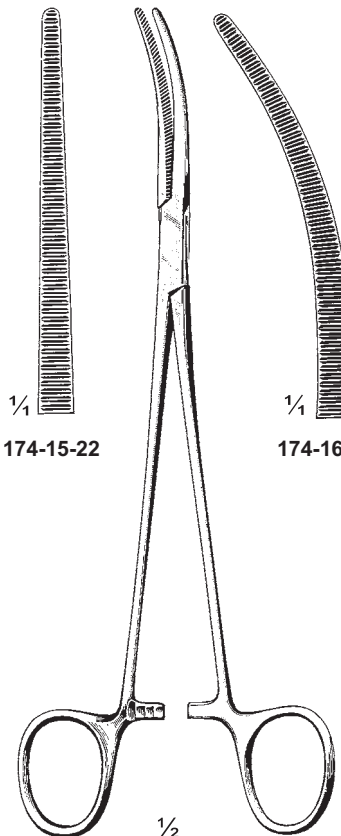

**Roberts**  
174-15-22 & 174-16-22  
22 cm / 8¾"

Arterienklemmen ; Pinzas hemostáticas  
 Haemostatic Forceps ; Pinze emostatica  
 Pincès hémostatiques ; Pinça hemostatica

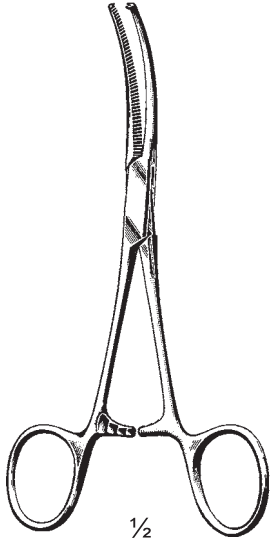

Kocher (Ochsner)  
 175-01-14 To 175-08-30  
 1 X 2 Teeth

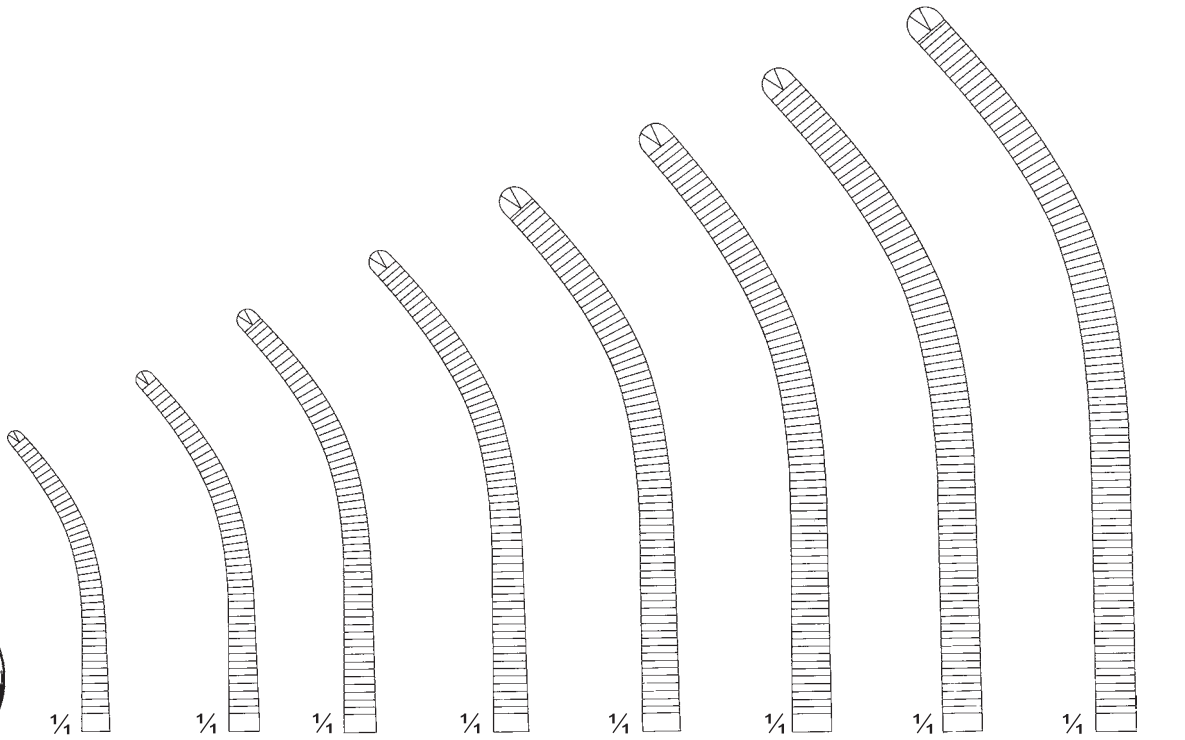

175-01-14 14 cm / 5½"  
 175-02-16 16 cm / 6¼"  
 175-03-18 18 cm / 7"  
 175-04-20 20 cm / 8"  
 175-05-22 22 cm / 8¾"  
 175-06-24 24 cm / 9½"  
 175-07-26 26 cm / 10¼"  
 175-08-30 30 cm / 12"

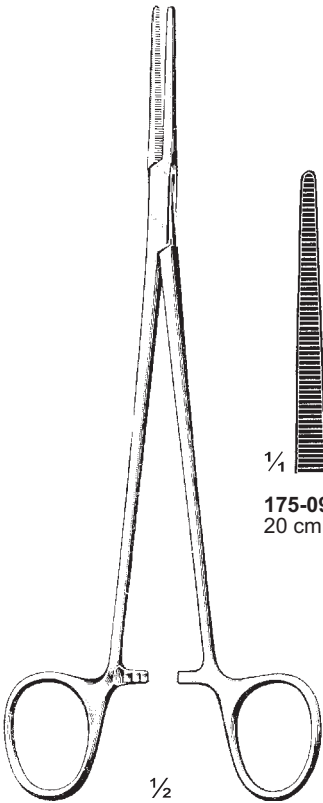

Heiss  
 175-09-20 To 175-14-24

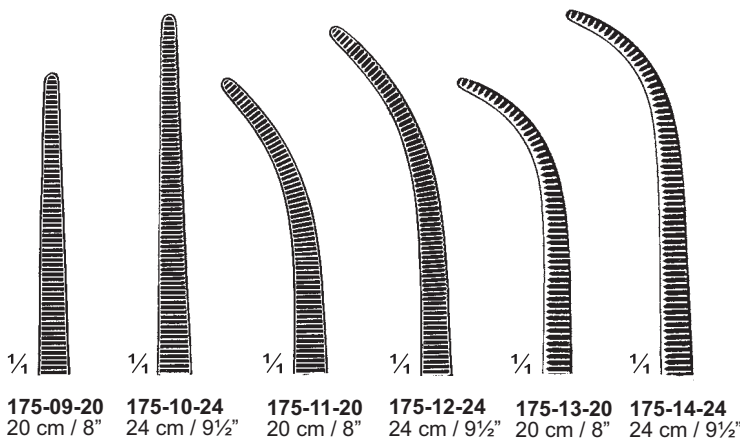

175-09-20 20 cm / 8"  
 175-10-24 24 cm / 9½"  
 175-11-20 20 cm / 8"  
 175-12-24 24 cm / 9½"  
 175-13-20 20 cm / 8"  
 175-14-24 24 cm / 9½"

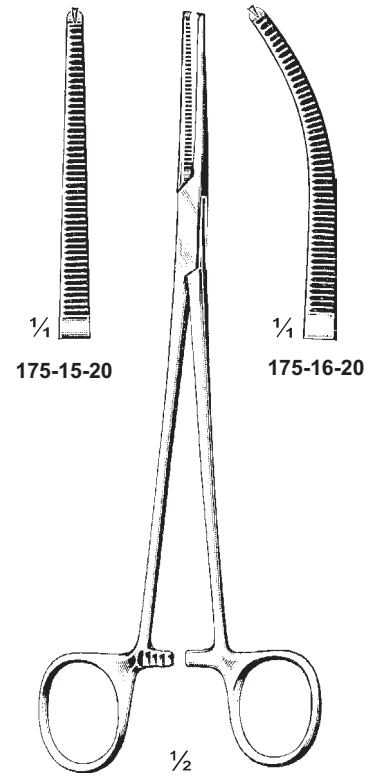

175-15-20  
 175-16-20

Heiss  
 175-15-20 & 175-16-20  
 20 cm / 8"  
 1 X 2 Teeth

Arterienklemmen ; Pinzas hemostáticas  
 Haemostatic Forceps ; Pinze emostatica  
 Pincés hémostatiques ; Pinça hemostatica

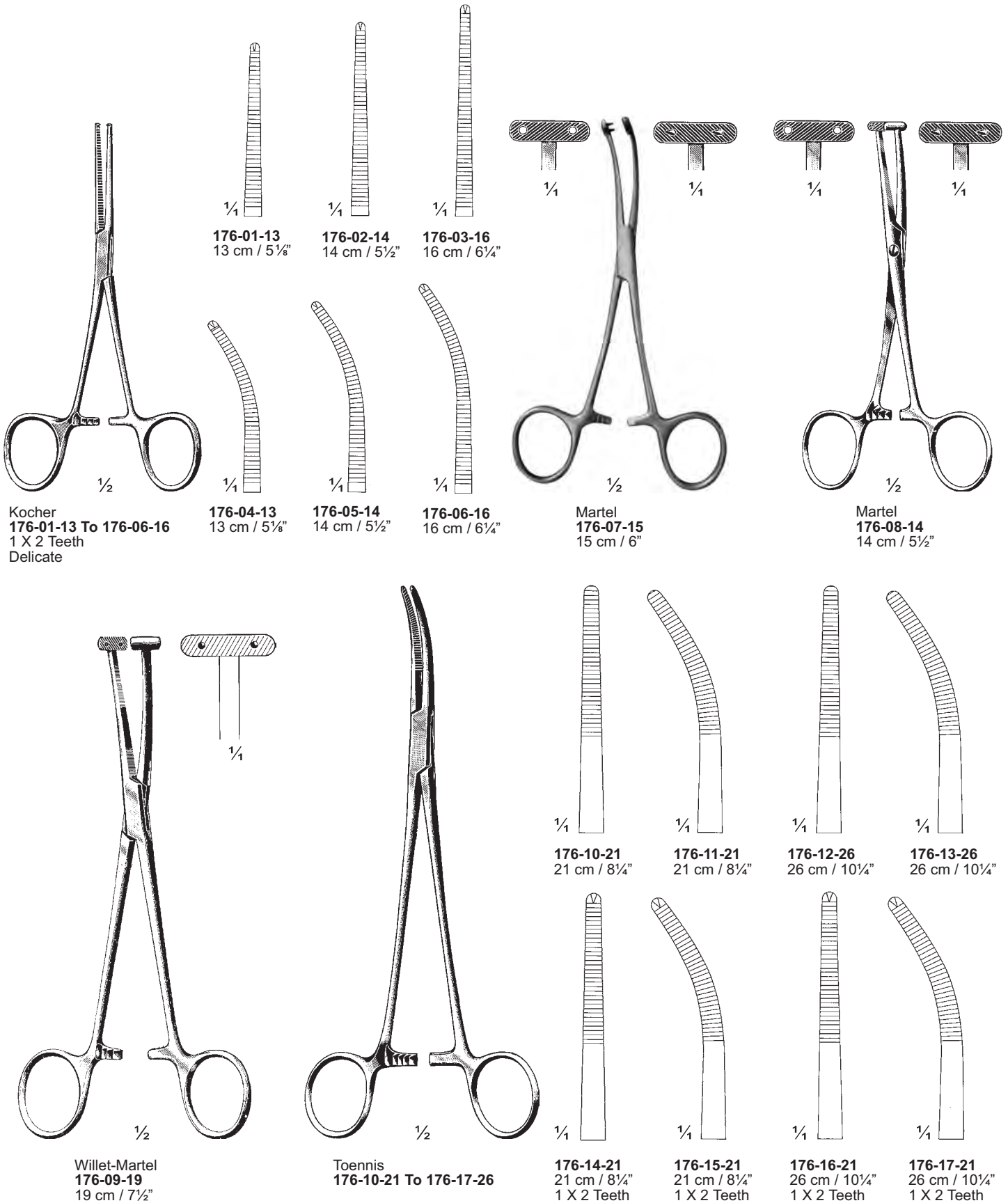

**Arterienklemmen ; Pinzas hemostáticas  
Haemostatic Forceps ; Pinze emostatica  
Pincas hémostatiques ; Pinça hemostatica**

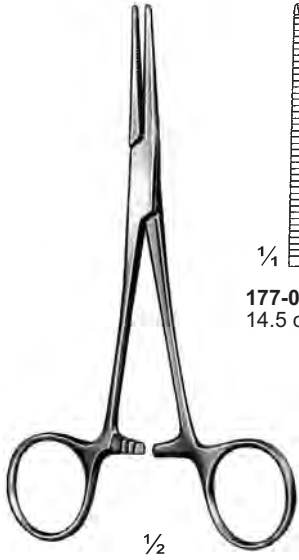

**Kocher-Nippon**  
**177-01-14 To 177-06-18**  
1 X 2 Teeth

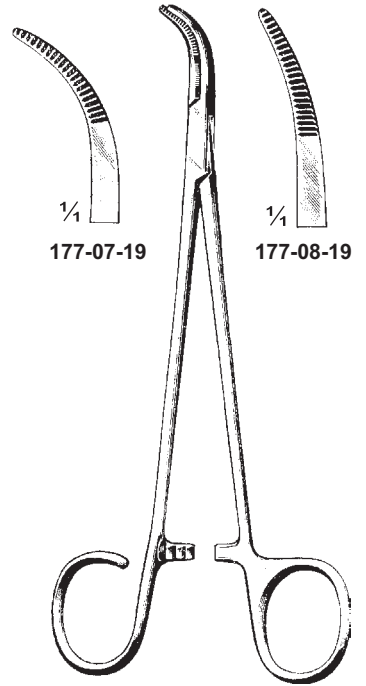
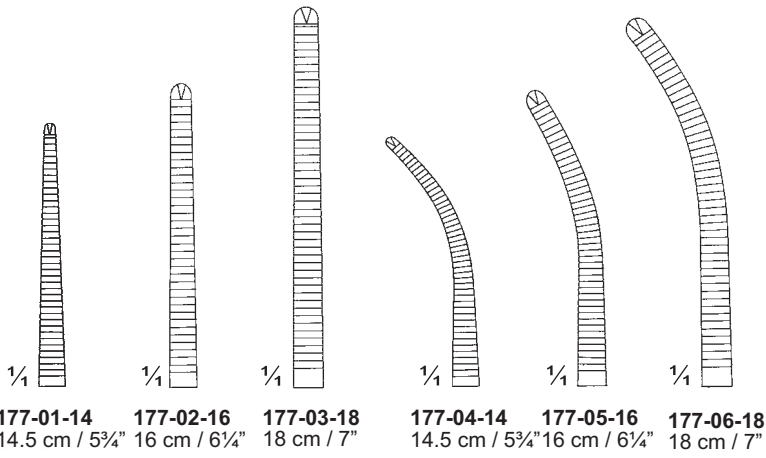

**Schmitt**  
**177-07-19 & 177-08-19**  
19 cm / 7½"

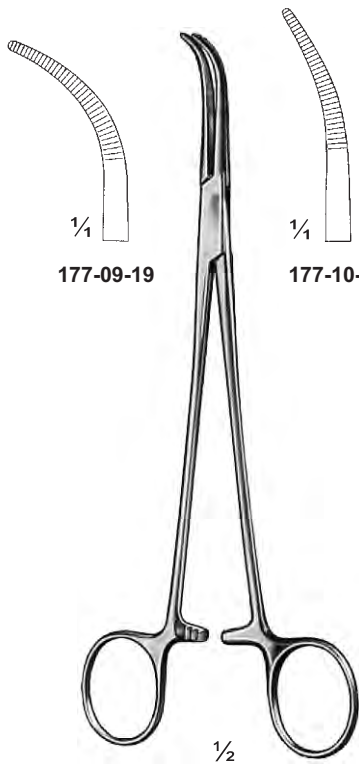

**Schmitt**  
**177-09-19 & 177-10-19**  
19 cm / 7½"

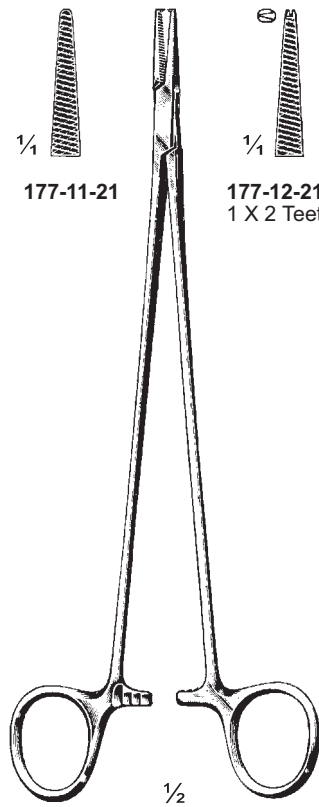

**Halstead**  
**177-11-21 & 177-12-21**  
21 cm / 8¼"

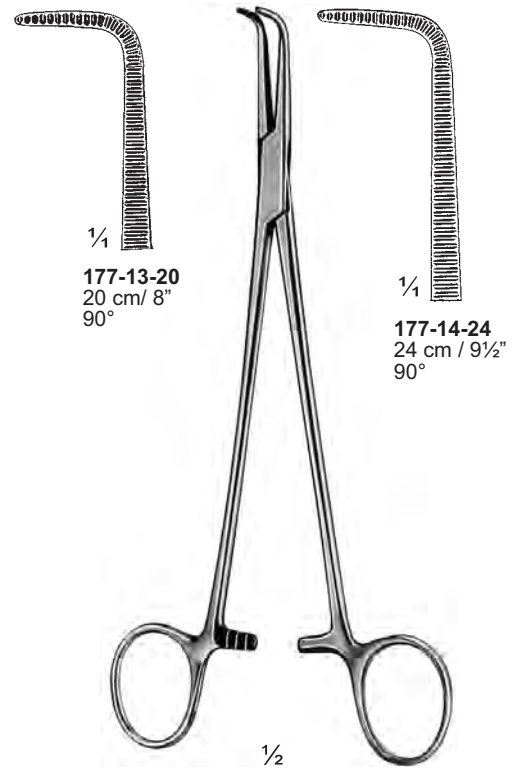

**Heiss**  
**177-13-20 & 177-14-24**

Arterienklemmen ; Pinzas hemostáticas  
 Haemostatic Forceps ; Pinze emostatica  
 Pincés hémostatiques ; Pinça hemostatica

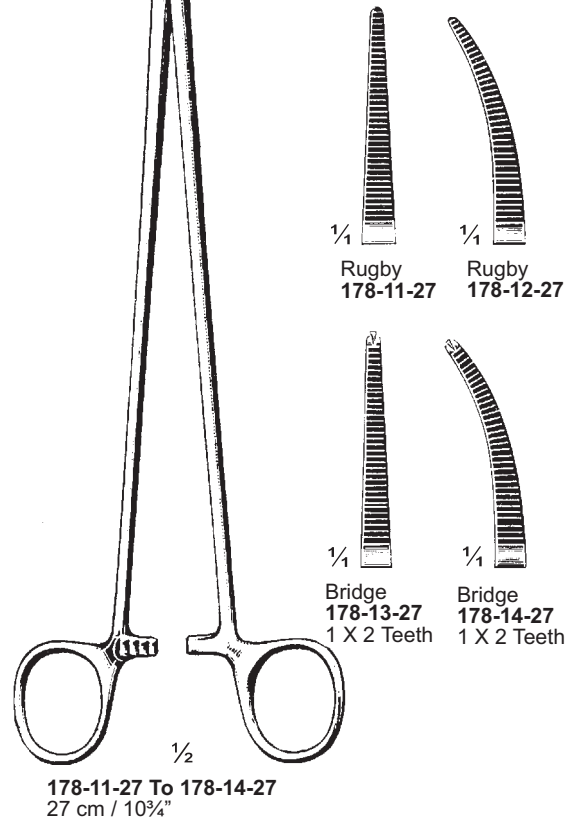
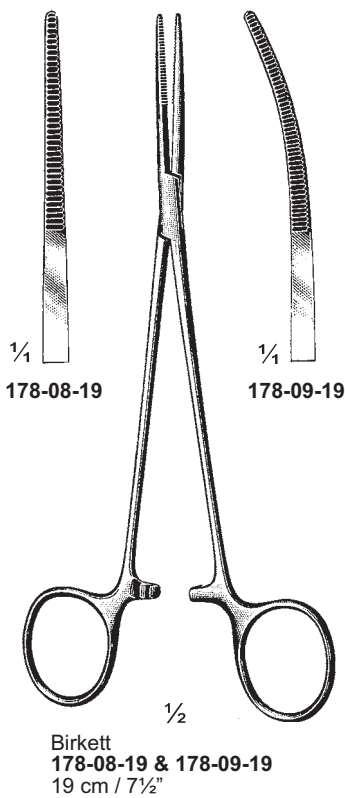
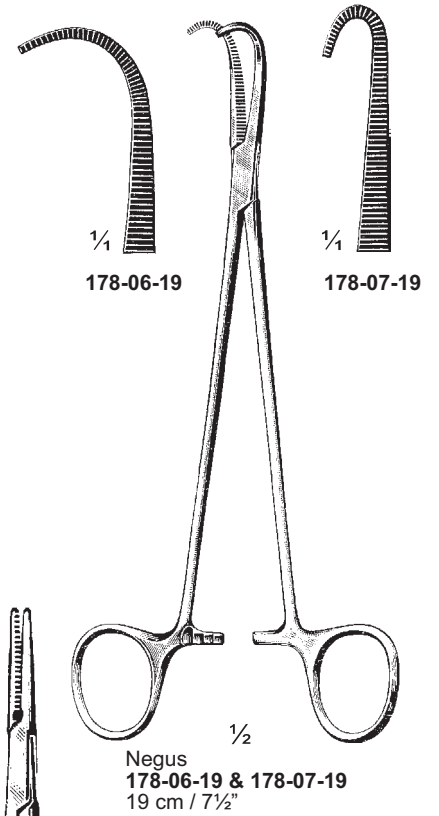
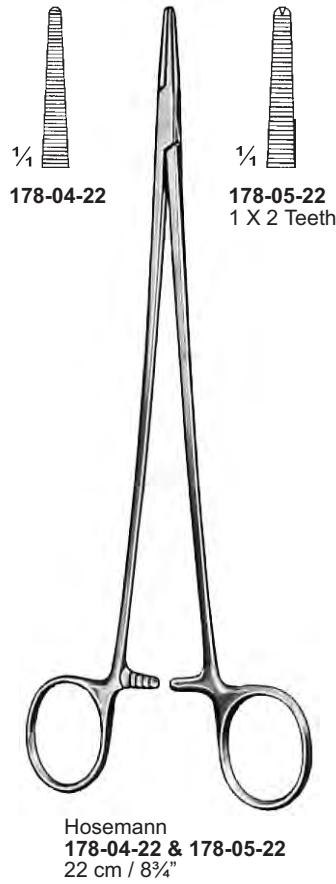
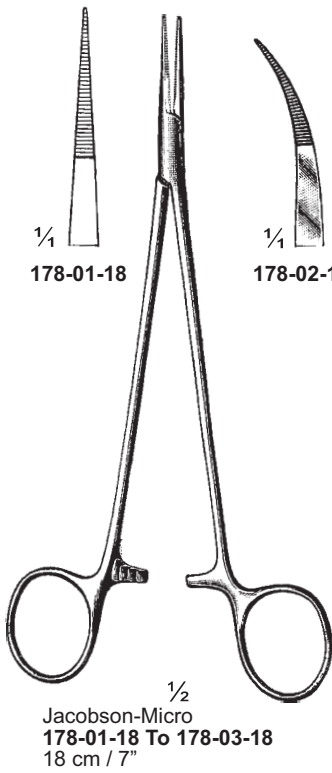



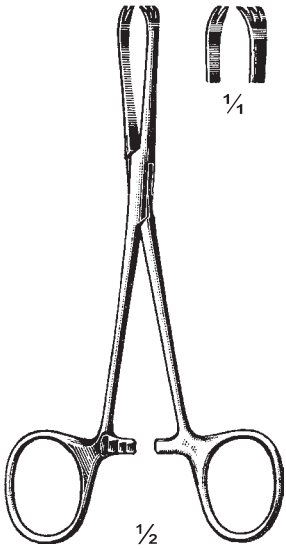

Chaput  
 179-01-14  
 14 cm / 5½"

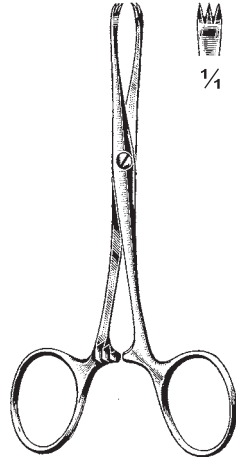

Chaput  
 179-02-13  
 13 cm / 5¼"

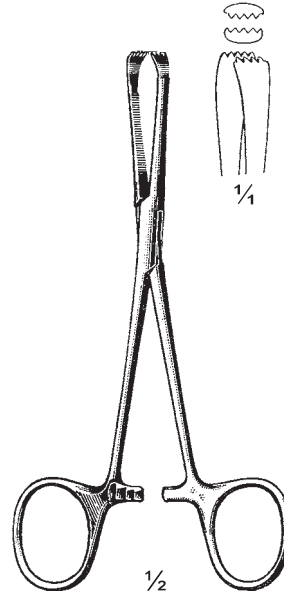

Tuffier  
 179-03-14  
 14 cm / 5½"

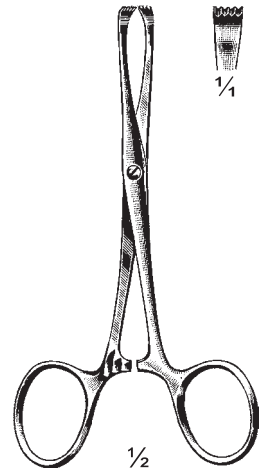

Tuffier  
 179-04-13  
 13 cm / 5¼"

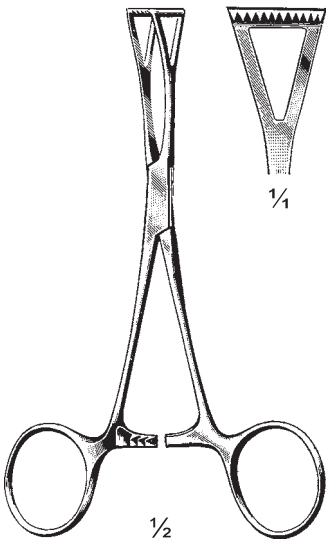

Collin  
 179-05-14  
 14 cm / 5½"

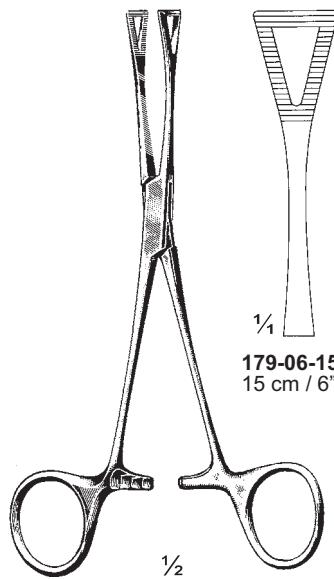

Pennington  
 179-06-15 & 179-07-20



179-07-20  
 20 cm / 8"

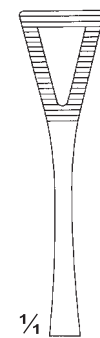

179-06-15  
 15 cm / 6"

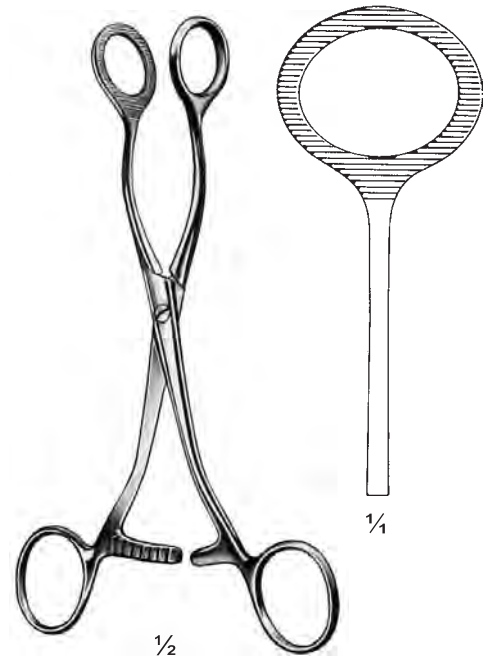

Collin  
 179-09-16  
 16.5 cm / 6½"



**180-01-25 & 180-02-26**  
Atrauma



$\frac{1}{4}$   
**180-01-25**  
25 cm / 10"

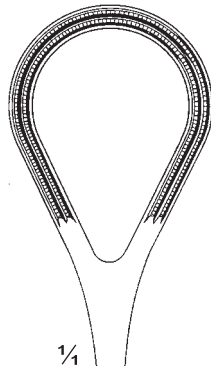

$\frac{1}{4}$   
**180-02-26**  
26 cm / 10 $\frac{1}{4}$ "

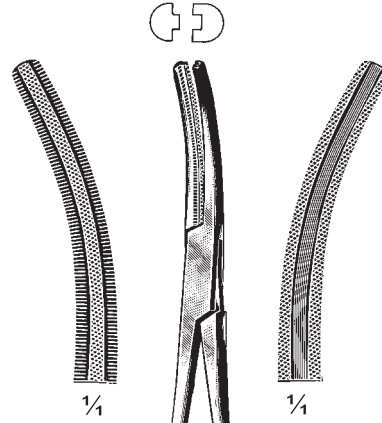

$\frac{1}{2}$   
Buie  
**180-03-21**  
21 cm / 8 $\frac{1}{4}$ "

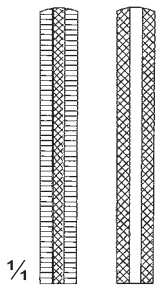

$\frac{1}{4}$   
**180-04-16**  
16 cm / 6 $\frac{1}{4}$ "

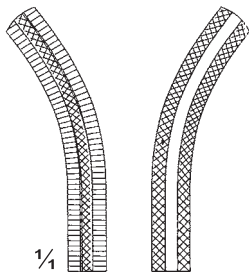

$\frac{1}{4}$   
**180-05-16**  
16 cm / 6 $\frac{1}{4}$ "

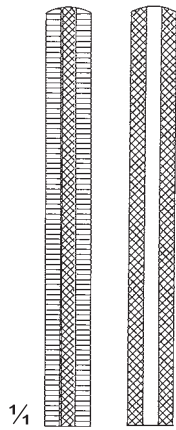

$\frac{1}{4}$   
**180-06-20**  
20 cm / 8"

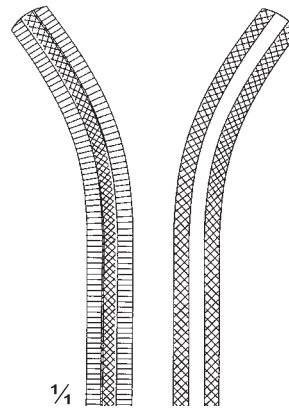

$\frac{1}{4}$   
**180-07-20**  
20 cm / 8"

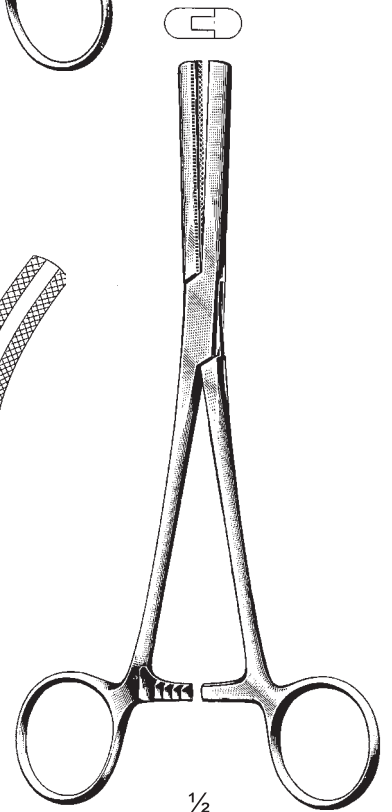

$\frac{1}{2}$   
Fergusson  
**180-04-16 To 180-07-20**

## Präparierklemmen Dissecting & Ligature Forceps Pincès à disséquer et à ligatures

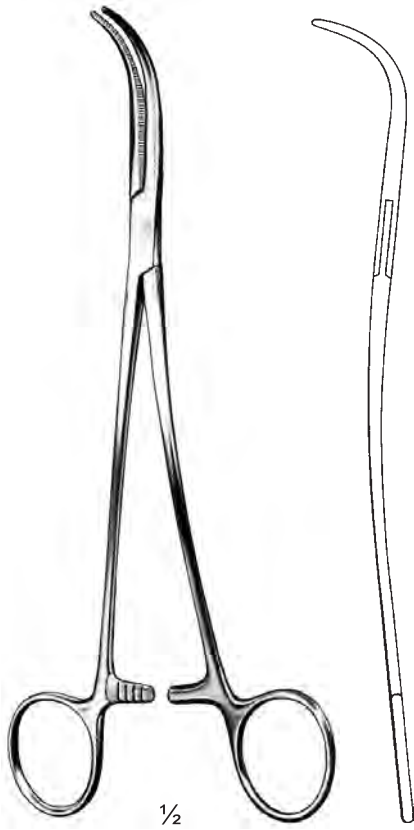

Overholt  
181-01-18 To 181-05-24

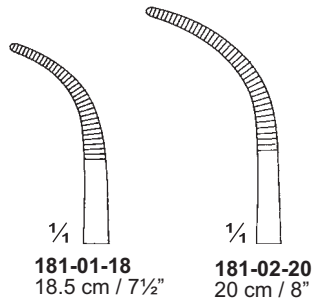

181-01-18  
18.5 cm / 7½"

181-02-20  
20 cm / 8"

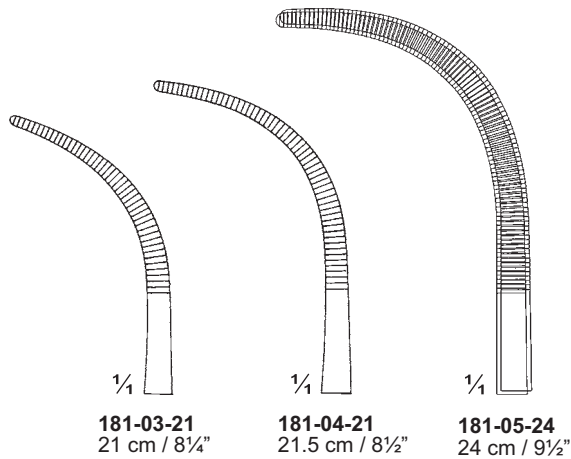

181-03-21  
21 cm / 8¼"

181-04-21  
21.5 cm / 8½"

181-05-24  
24 cm / 9½"

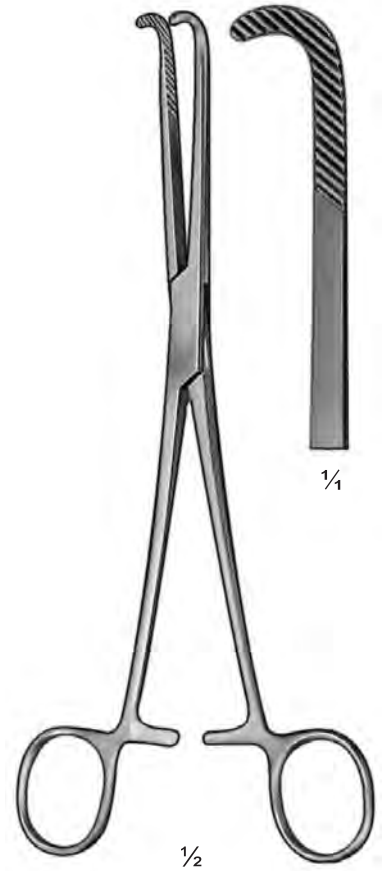

Nissen  
181-06-21  
21.5 cm / 8½"

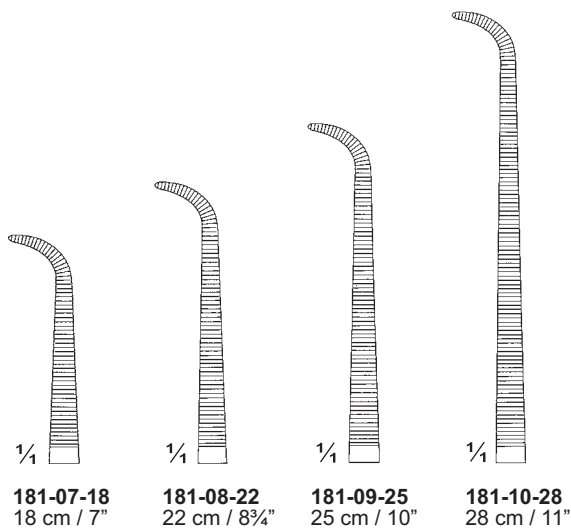

181-07-18  
18 cm / 7"

181-08-22  
22 cm / 8¾"

181-09-25  
25 cm / 10"

181-10-28  
28 cm / 11"



Mini-Gemini  
181-07-18 To 181-10-28

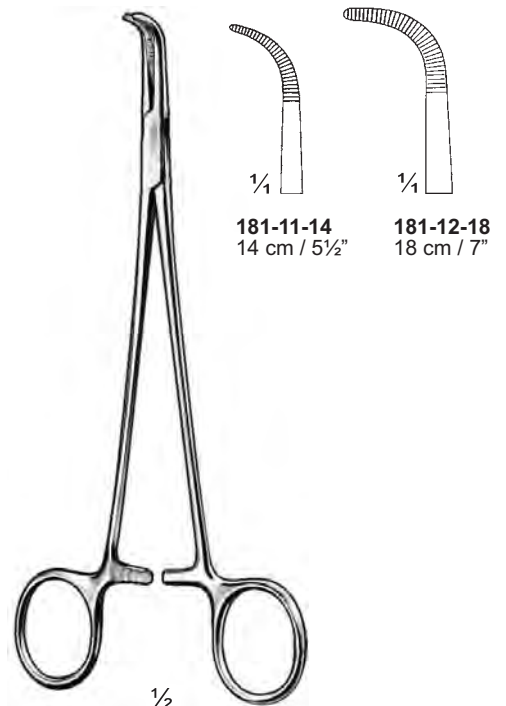

181-11-14  
14 cm / 5½"

181-12-18  
18 cm / 7"

Baby-Adson  
181-11-14 & 181-12-18

**Präparierklemmen**  
**Dissecting & Ligature Forceps**  
**Pinces à disséquer et à ligatures**

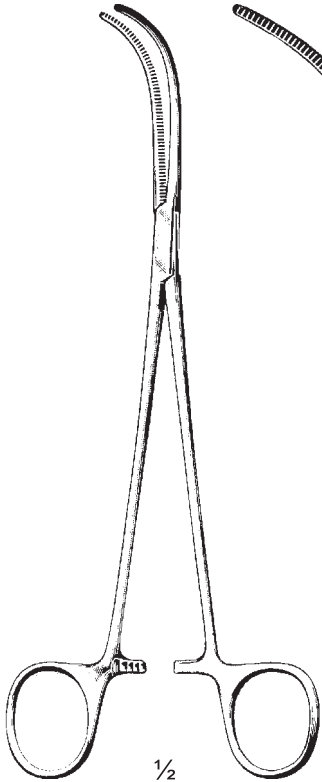

**Overholt-Mixer**  
**182-01-21**  
 21 cm / 8 1/4"

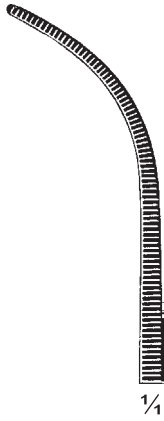

1/4

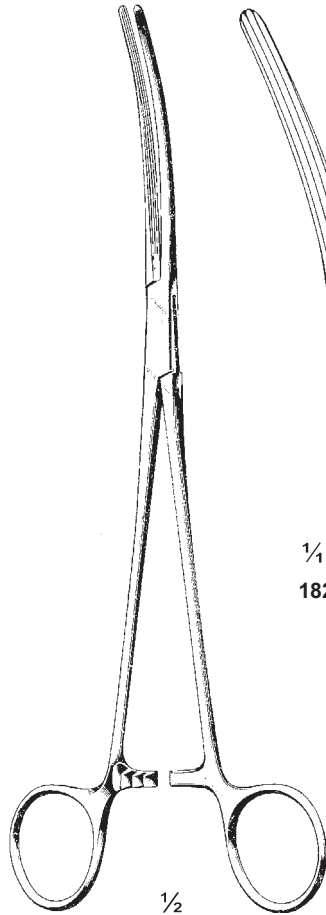

**Crafoord-Sellors**  
**182-02-24 To 182-04-24**  
 24 cm / 9 1/2"

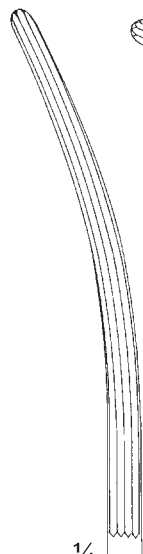

1/4

**182-02-24**

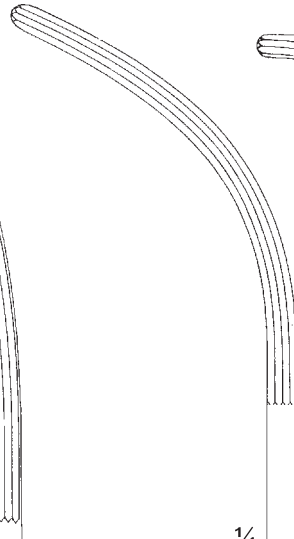

1/4

**182-03-24**

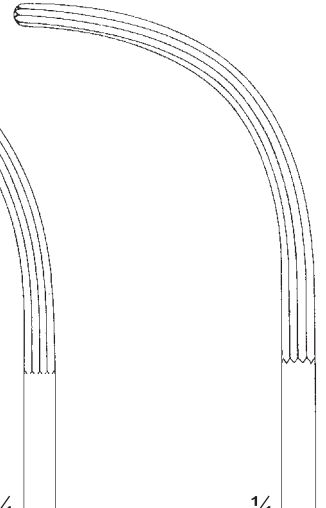

1/4

**182-04-24**

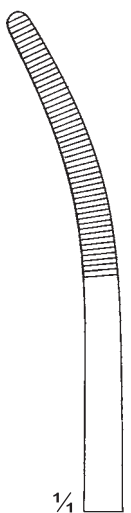

1/4

**182-05-23**



1/4

**182-06-23**

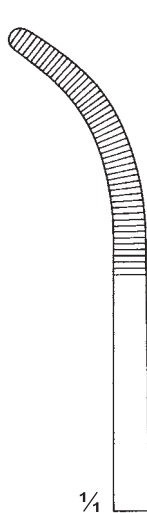

1/4

**182-07-23**



1/4

**182-08-23**

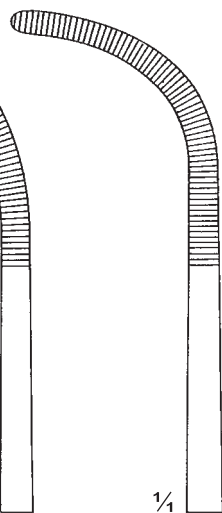

1/4

**182-09-23**



1/2

**Rumel**  
**182-05-23 To 182-09-23**  
 23 cm / 9"

# Präparierklemmen Dissecting & Ligature Forceps Pincès à disséquer et à ligatures

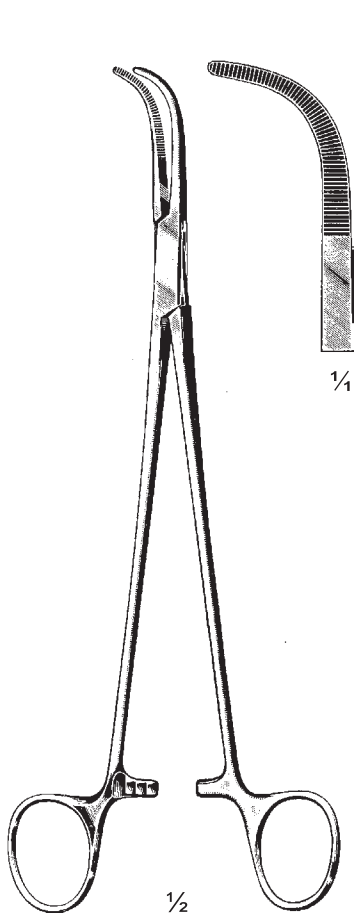

Mixer  
183-01-23  
23 cm / 9"



83-02-24

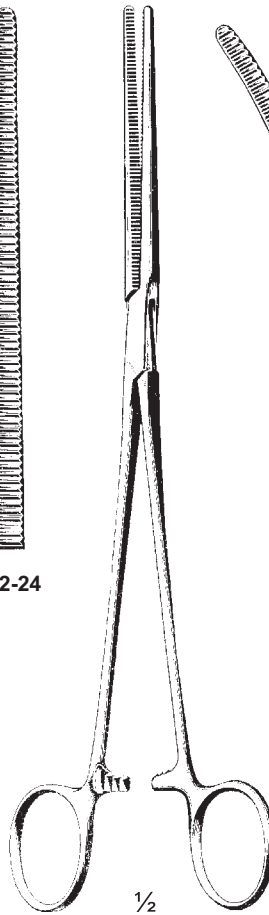

Sarot  
183-02-24 & 183-03-24  
24 cm / 9 1/2"

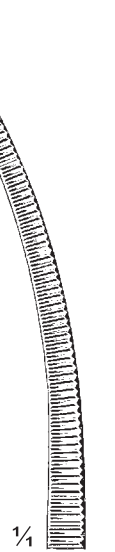

183-03-24

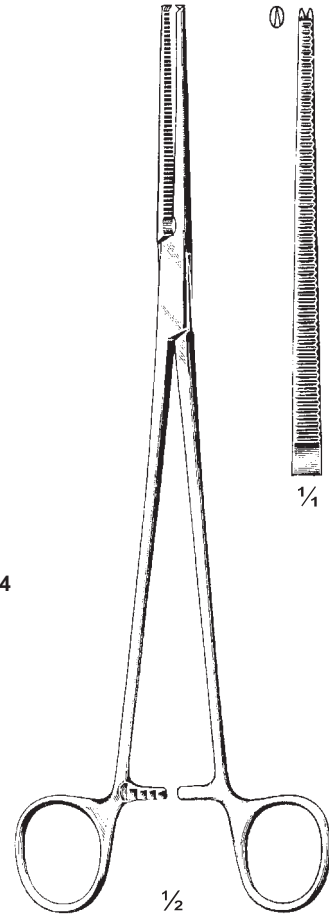

Sarot  
183-04-24  
24 cm / 9 1/2"  
1 X 2 Teeth



183-05-13  
13 cm / 5 1/8"

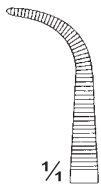

183-06-16  
16 cm / 6 1/4"

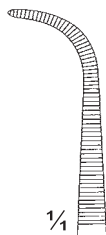

183-07-18  
18 cm / 7"

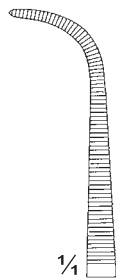

183-08-20  
20 cm / 8"

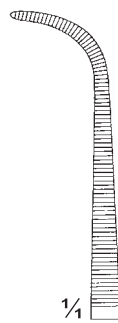

183-09-23  
23 cm / 9"

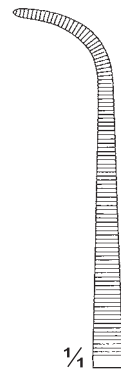

183-10-25  
25 cm / 10"

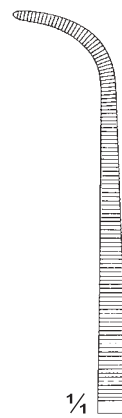

183-11-28  
28 cm / 11"



Gemini  
183-05-13 To 183-11-28

**Präparierklemmen**  
**Dissecting & Ligature Forceps**  
**Pinces à disséquer et à ligatures**

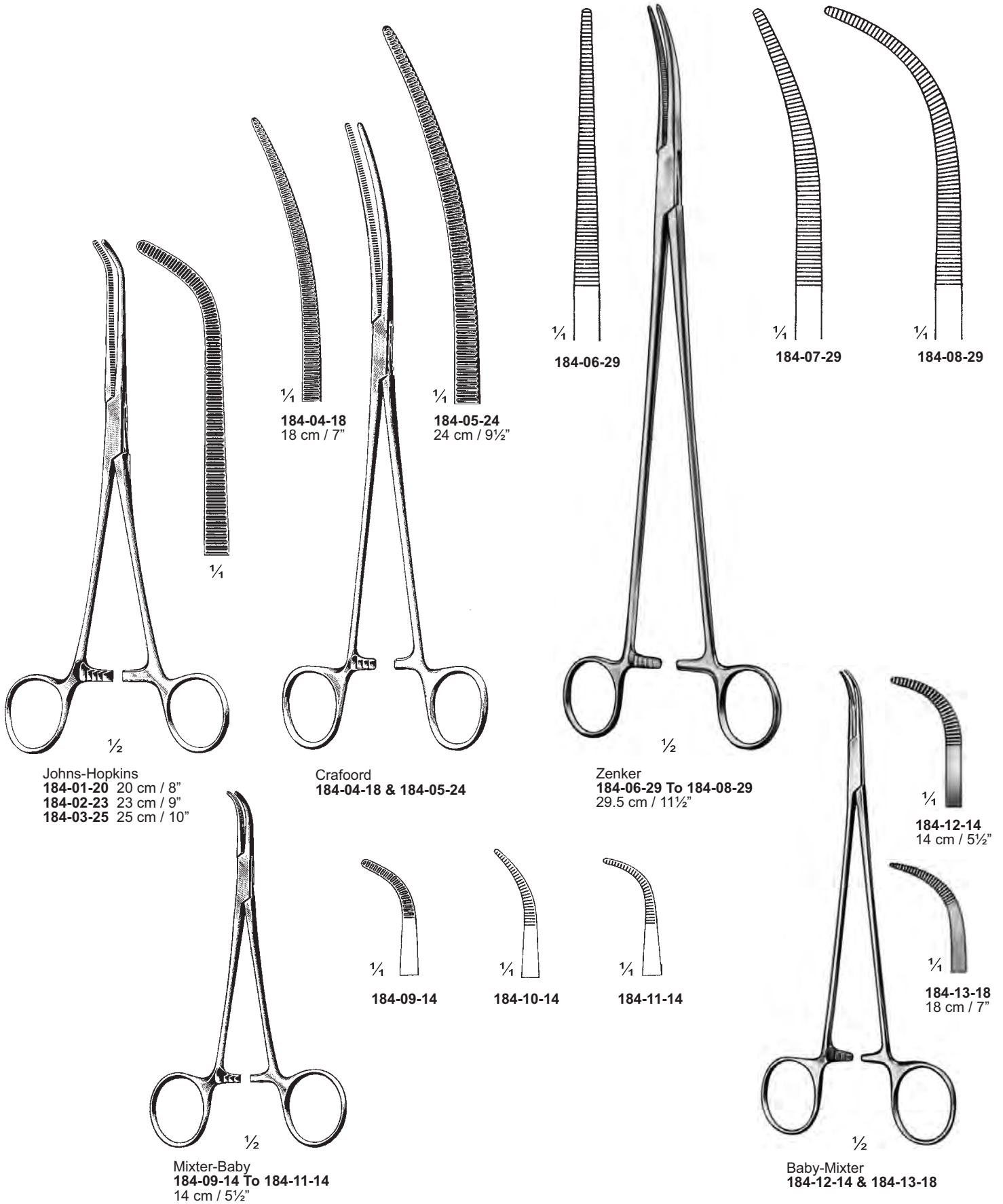



**Präparierklemmen**  
**Dissecting & Ligature Forceps**  
**Pinces à disséquer et à ligatures**

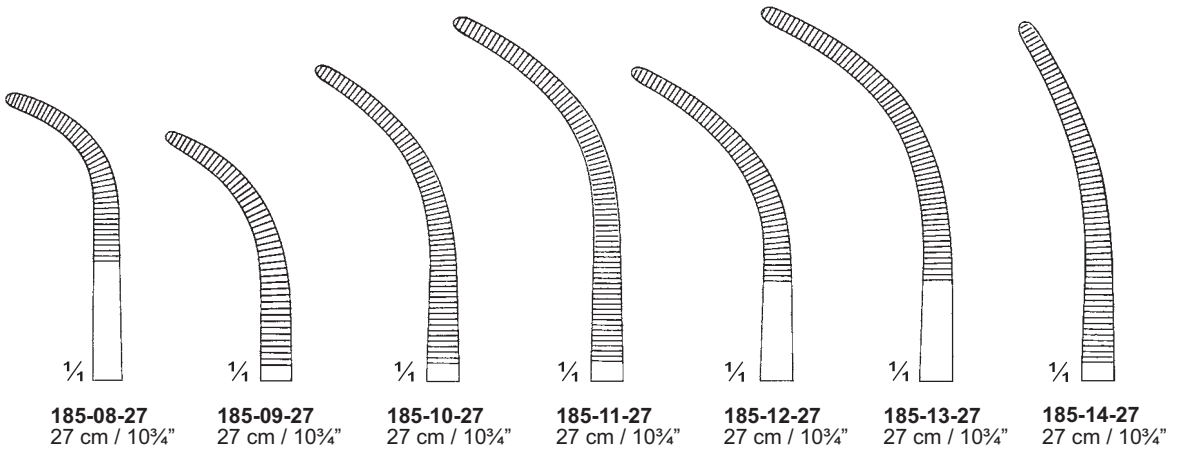
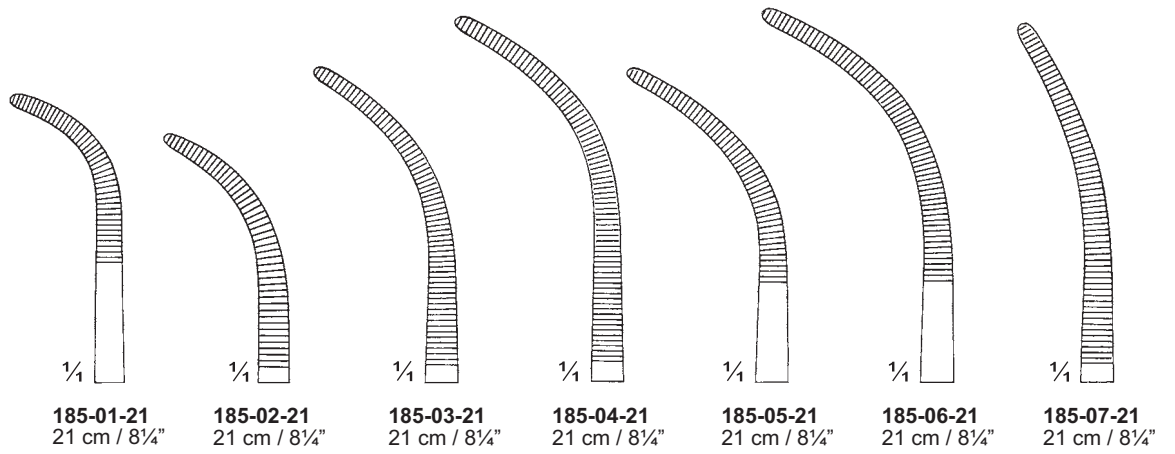

Overholt-Geissendoerfer  
 185-01-21 To 185-14-27

**Präparierklemmen**  
**Dissecting & Ligature Forceps**  
**Pinces à disséquer et à ligatures**



Lawrence  
**186-01-27**  
 27.5 cm / 10<sup>3</sup>/<sub>4</sub>"

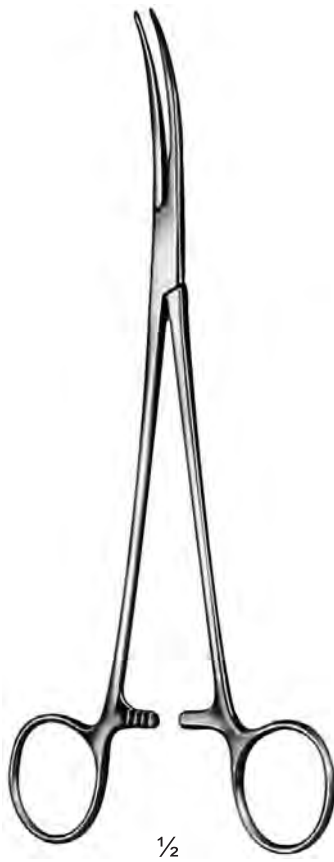

Kelly  
**186-02-19 To 186-10-24**

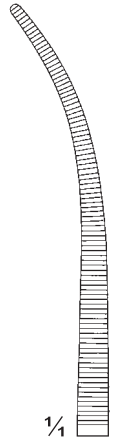
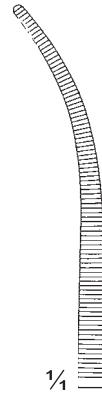

**186-02-19**  
 19 cm / 7<sup>1</sup>/<sub>2</sub>"

**186-03-22**  
 22 cm / 8<sup>3</sup>/<sub>4</sub>"

**186-04-24**  
 24 cm / 9<sup>1</sup>/<sub>2</sub>"

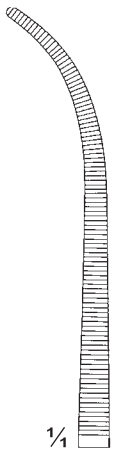
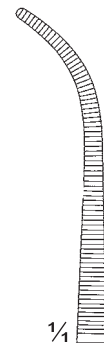

**186-05-19**  
 19 cm / 7<sup>1</sup>/<sub>2</sub>"

**186-06-22**  
 22 cm / 8<sup>3</sup>/<sub>4</sub>"

**186-07-24**  
 24 cm / 9<sup>1</sup>/<sub>2</sub>"

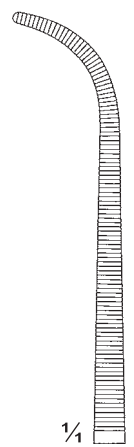

**186-08-19**  
 19 cm / 7<sup>1</sup>/<sub>2</sub>"

**186-09-22**  
 22 cm / 8<sup>3</sup>/<sub>4</sub>"

**186-10-24**  
 24 cm / 9<sup>1</sup>/<sub>2</sub>"

**Bronchusklemmen  
Bronchus & Gall Duct Clamp  
Pince - clamps à bronches**

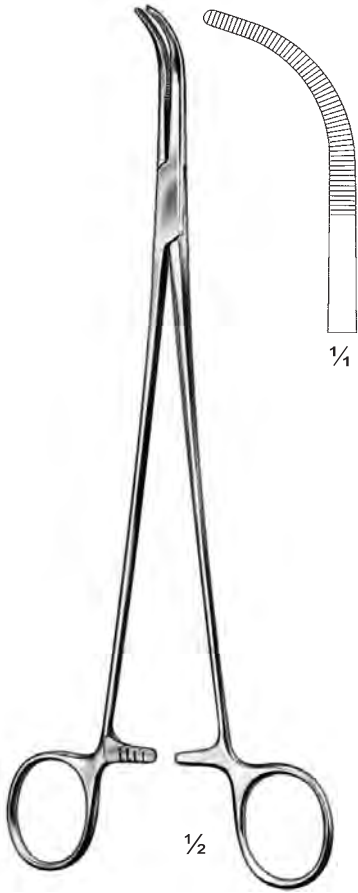

Mixer  
**187-01-23**  
23 cm / 9"

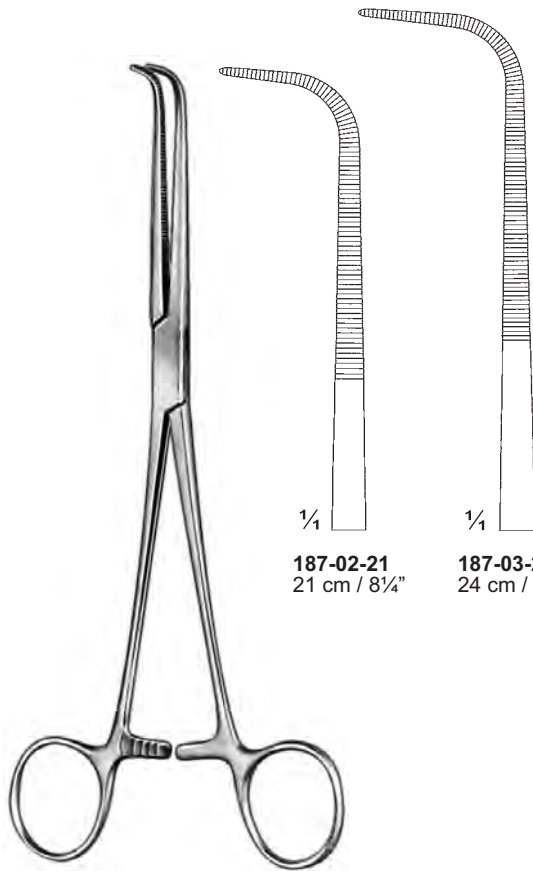

Wickstrom  
**187-02-21 & 187-03-24**

**187-02-21**  
21 cm / 8 1/4"

**187-03-24**  
24 cm / 9 1/2"

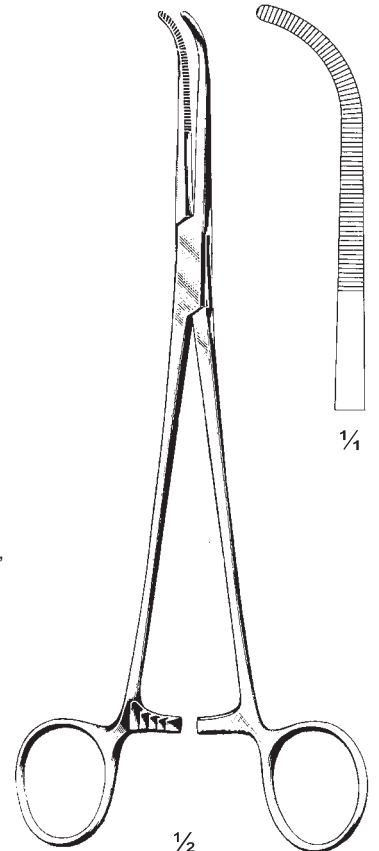

Mixer  
**187-04-22**  
22 cm / 8 3/4"

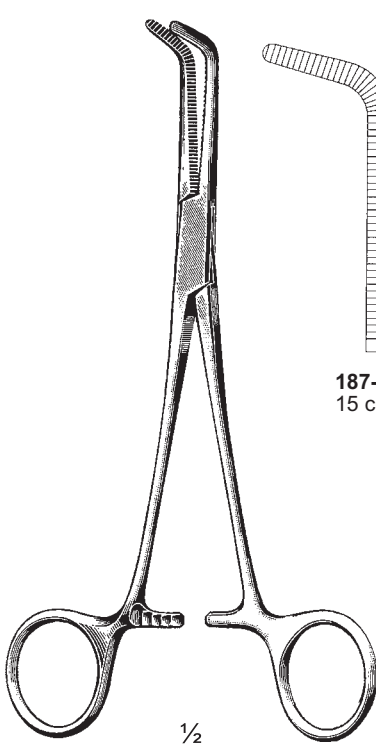

Mixer  
**187-05-15 & 187-06-19**

**187-05-15**  
15 cm / 6"

**187-06-19**  
19 cm / 7 1/2"

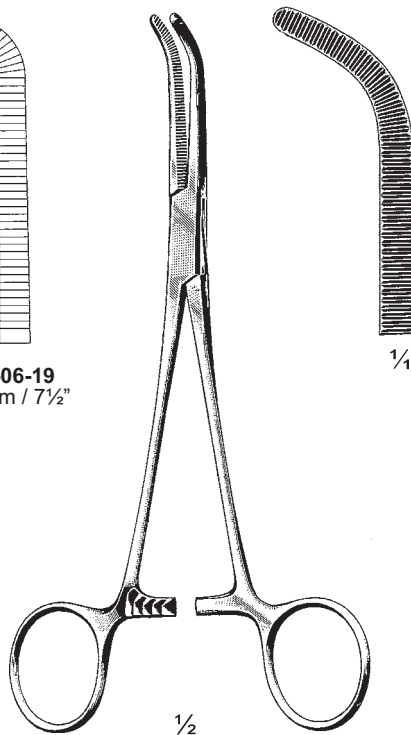

Mixer-O'Shaughnessy  
**187-07-19**  
19 cm / 7 1/2"



Rochester-Mixer  
**187-08-16 & 187-09-20**

**187-08-16** **187-09-20**  
16 cm / 6 1/4" 20 cm / 8"

**Bronchusklemmen**  
**Bronchus & Gall Duct Clamp**  
**Pince - clamps à bronches**

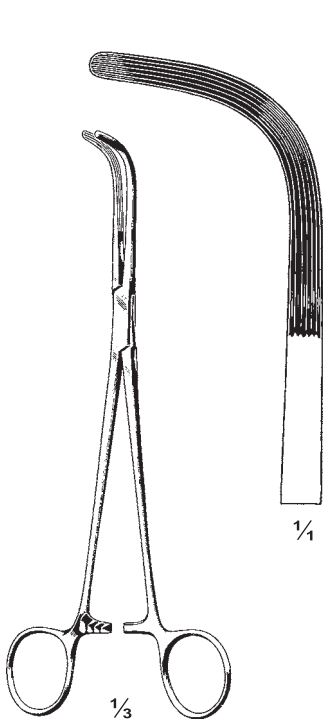

**McQuigg-Mixer**  
**188-01-22**  
 22 cm / 8 3/4"

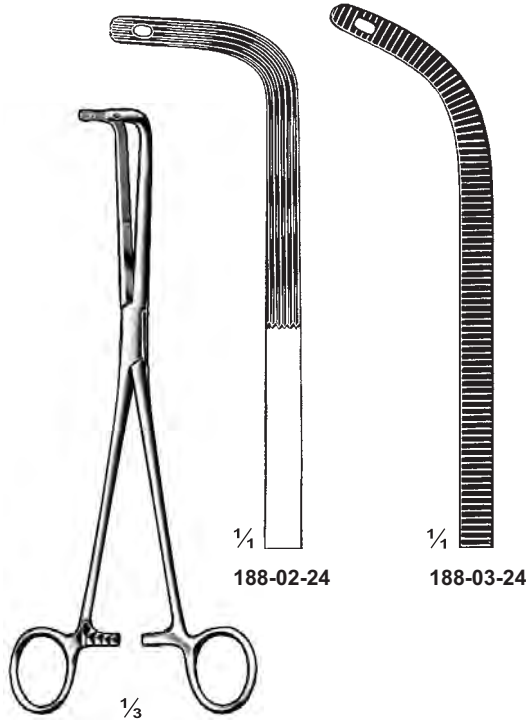

**Finocchietto**  
**188-02-24 & 188-03-24**  
 24 cm / 9 1/2"

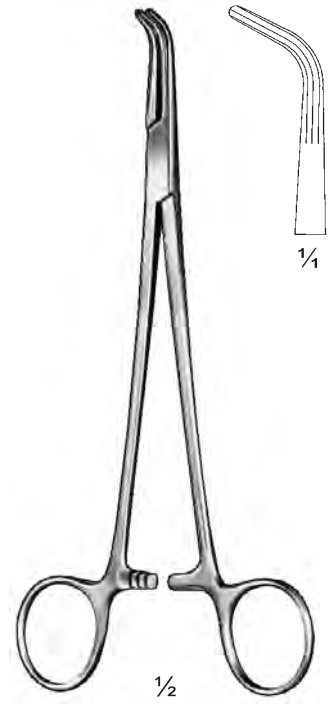

**Lower**  
**188-04-18**  
 18 cm / 7"

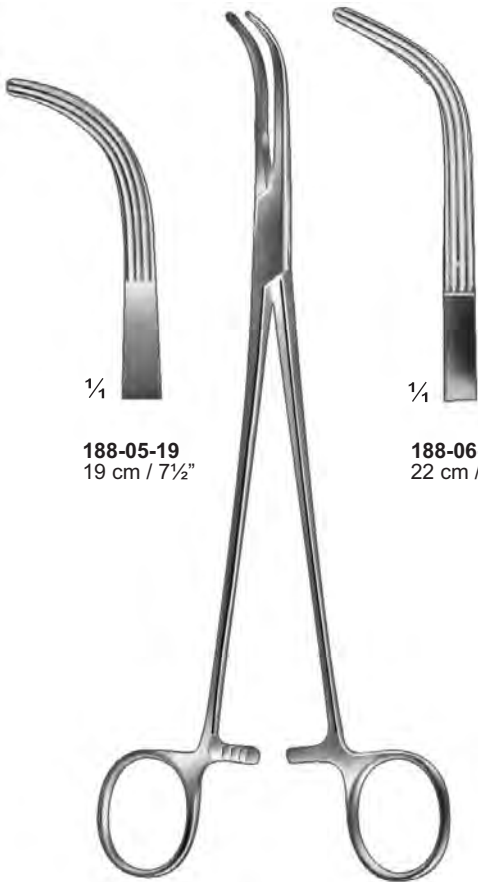

**188-05-19**  
 19 cm / 7 1/2"

**Lahey (Sweet)**  
**188-05-19 & 188-06-22**



**188-06-22**  
 22 cm / 8 3/4"



**Lahey**  
**188-07-19 & 188-08-23**

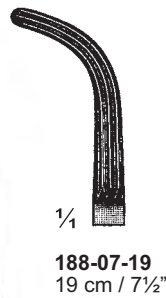

**188-07-19**  
 19 cm / 7 1/2"

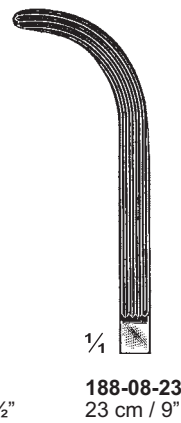

**188-08-23**  
 23 cm / 9"

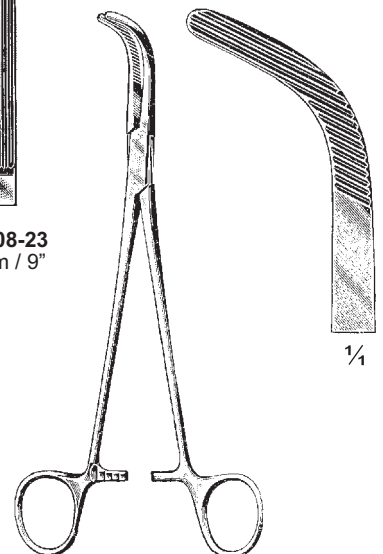

**Crile-Mixer**  
**188-09-18**  
 18 cm / 7"

**Bronchusklemmen**  
**Bronchus & Gall Duct Clamp**  
**Pince - clamps à bronches**

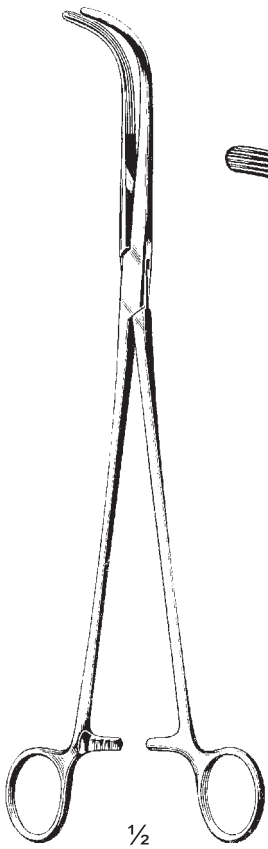

Mixer  
 189-01-22 To 189-03-28

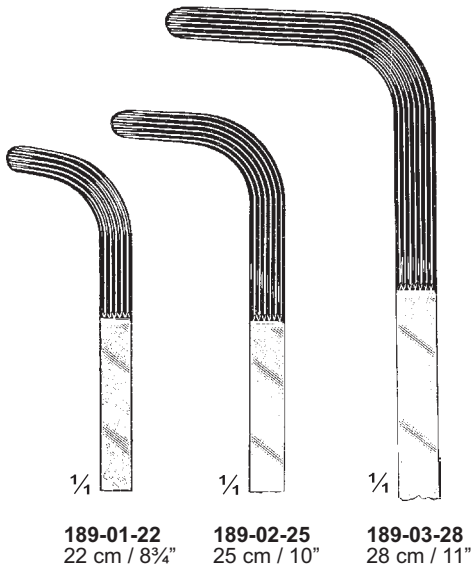

189-01-22  
 22 cm / 8 3/4"

189-02-25  
 25 cm / 10"

189-03-28  
 28 cm / 11"

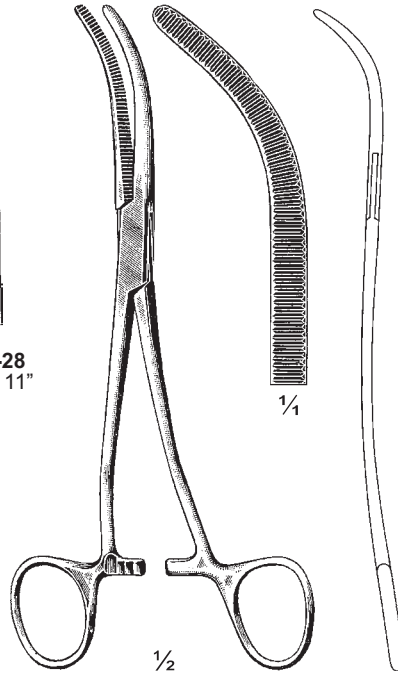

Dean-Shallcross  
 189-04-18  
 18 cm / 7"

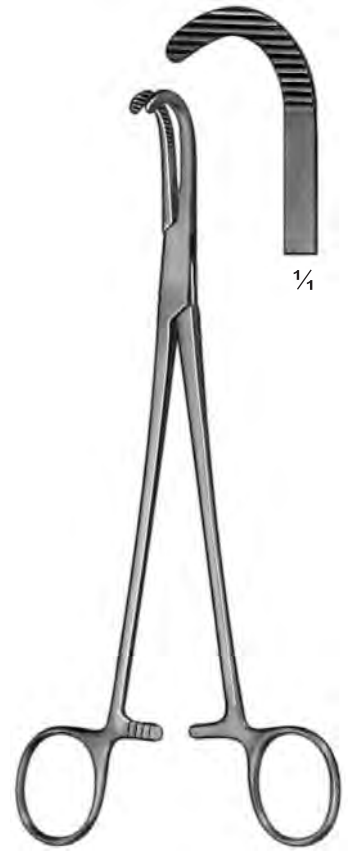

Desjardins  
 189-05-22  
 22 cm / 8 3/4"

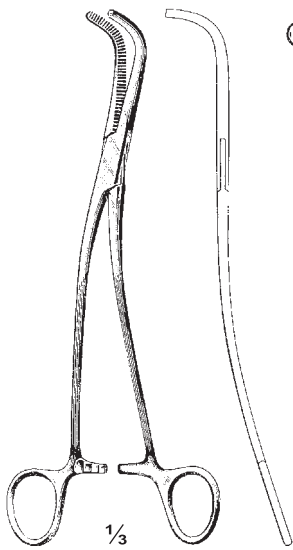

Gray  
 189-06-22 To 189-09-23

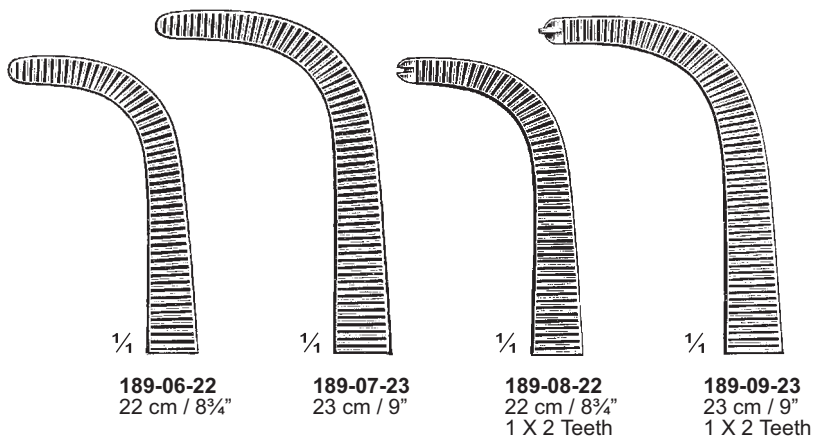

189-06-22  
 22 cm / 8 3/4"

189-07-23  
 23 cm / 9"

189-08-22  
 22 cm / 8 3/4"  
 1 X 2 Teeth

189-09-23  
 23 cm / 9"  
 1 X 2 Teeth

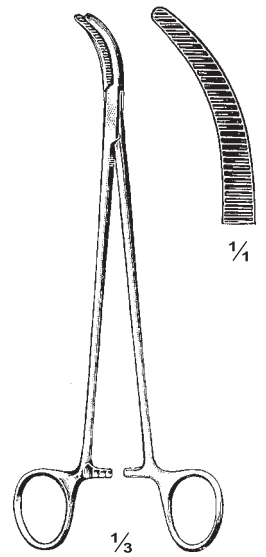

Desjardins  
 189-10-21  
 21 cm / 8 1/4"

**Nierenstielklemmen**  
**Kidney Pedicle Clamps**  
**Pince - clamps pour pédicules rénaux**



$\frac{1}{2}$   
 Guyon  
 190-01-19 To 190-04-26



$\frac{1}{4}$   
 190-01-19  
 19.5 cm / 7 $\frac{3}{4}$ "



$\frac{1}{4}$   
 190-02-22  
 22 cm / 8 $\frac{3}{4}$ "



$\frac{1}{4}$   
 190-03-23  
 23 cm / 9"



$\frac{1}{4}$   
 190-04-26  
 26.5 cm / 10 $\frac{1}{4}$ "



$\frac{1}{2}$   $\frac{1}{4}$   
 190-05-24  
 24 cm / 9 $\frac{1}{2}$ "

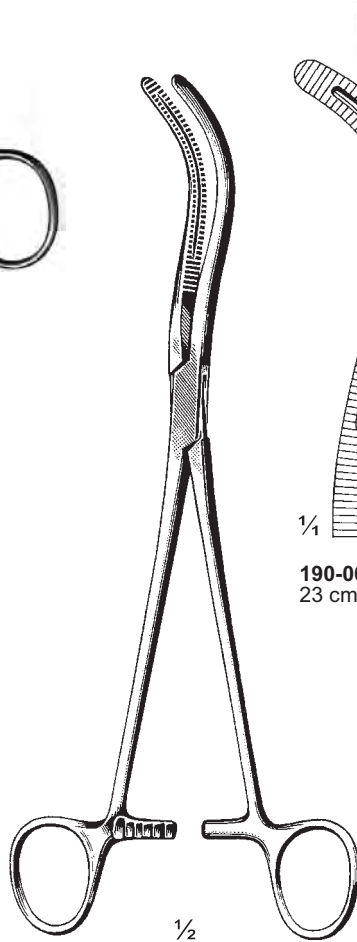

$\frac{1}{2}$   
 Stille  
 190-05-23 To 190-07-24

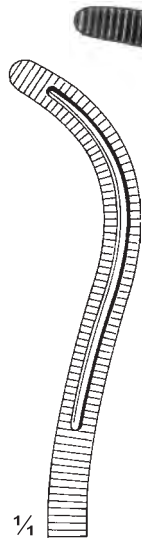

$\frac{1}{4}$   
 190-06-23  
 23 cm / 9"



$\frac{1}{4}$   
 190-07-24  
 24 cm / 9 $\frac{1}{2}$ "

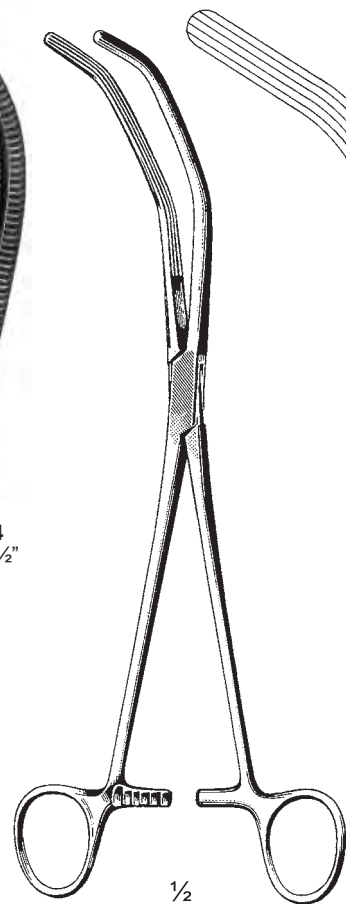

$\frac{1}{2}$   
 Herrick  
 190-08-23  
 23 cm / 9"

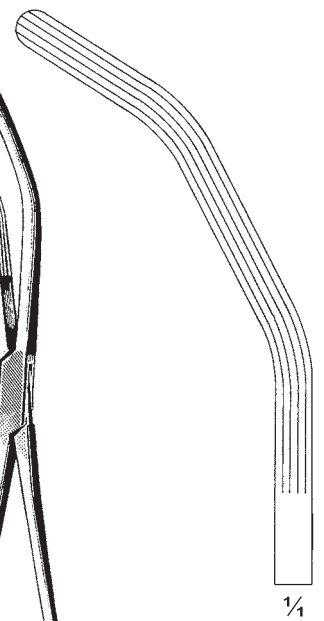

$\frac{1}{4}$



**Nierenstielklemmen**  
**Kidney Pedicle Clamps**  
**Pince - clamps pour pédicules rénaux**

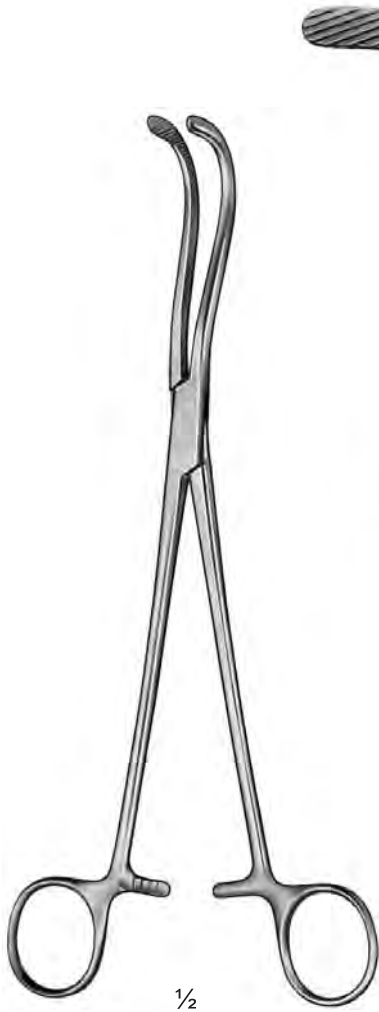

$\frac{1}{2}$   
Guyon  
191-01-23  
23.5 cm / 9 $\frac{1}{4}$ "

$\frac{1}{4}$



$\frac{1}{4}$

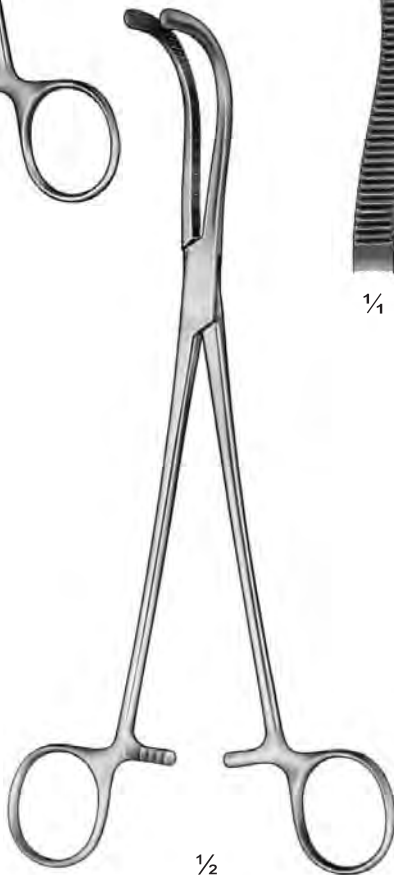

$\frac{1}{2}$   
Guyon  
191-02-23  
23 cm / 9"

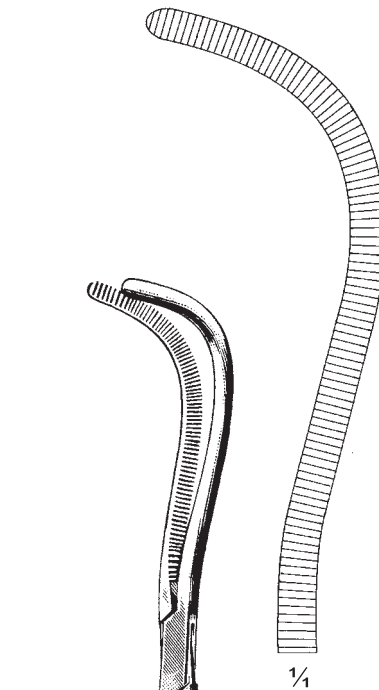

$\frac{1}{4}$

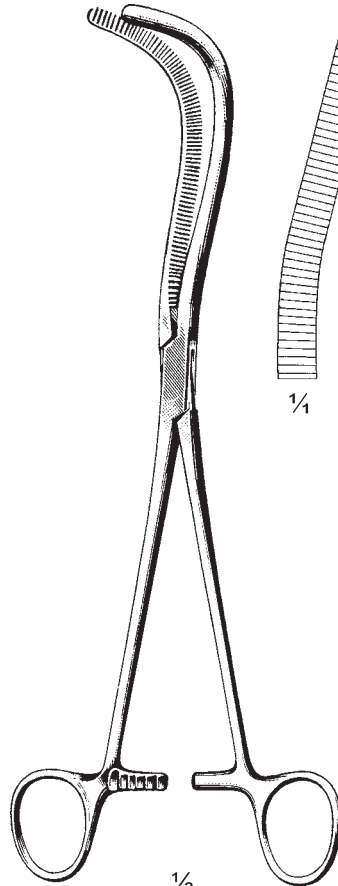

$\frac{1}{2}$   
Mayo-Guyon  
191-03-23  
23 cm / 9"

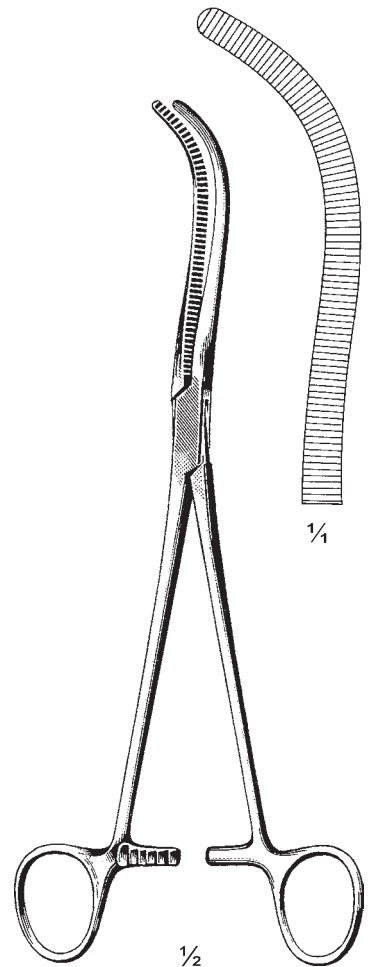

$\frac{1}{4}$

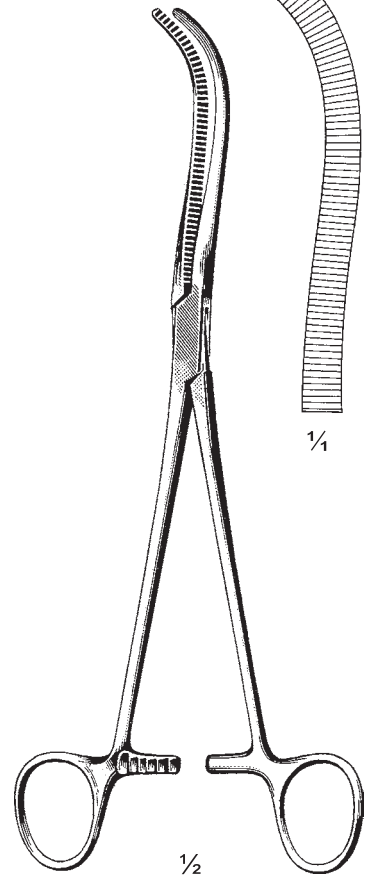

$\frac{1}{2}$   
Mayo  
191-04-23  
23 cm / 9"

**Hysterektomieklemmen**  
**Hysterectomy Forceps**  
**Pinces à hystérectomie**



$\frac{1}{4}$   
 192-01-21

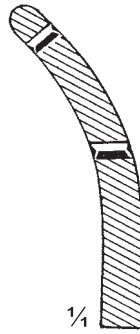

$\frac{1}{4}$   
 192-02-21

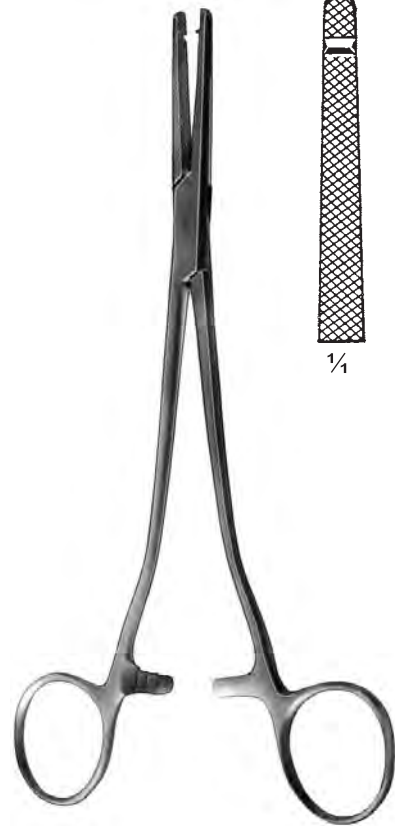

$\frac{1}{4}$

Heaney  
 192-01-21 & 192-02-21  
 21 cm / 8 $\frac{1}{4}$ "

Heaney-Rezek  
 192-03-21  
 21 cm / 8 $\frac{1}{4}$ "

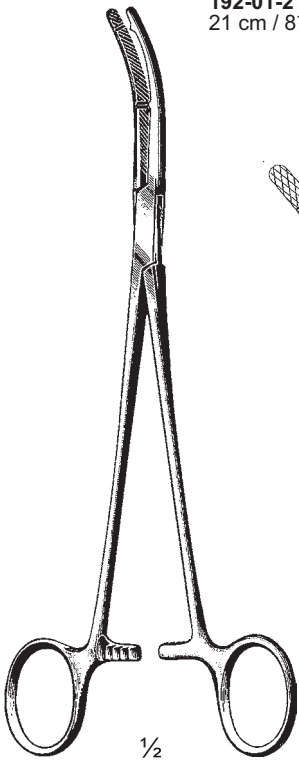

$\frac{1}{2}$

Heaney  
 192-04-19 To 192-06-23

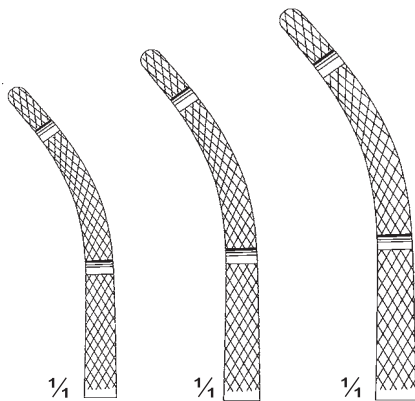

$\frac{1}{4}$

$\frac{1}{4}$

$\frac{1}{4}$

192-04-19 192-05-21  
 19.5 cm / 7 $\frac{3}{4}$ " 21 cm / 8 $\frac{1}{4}$ "

192-06-23  
 23 cm / 9"

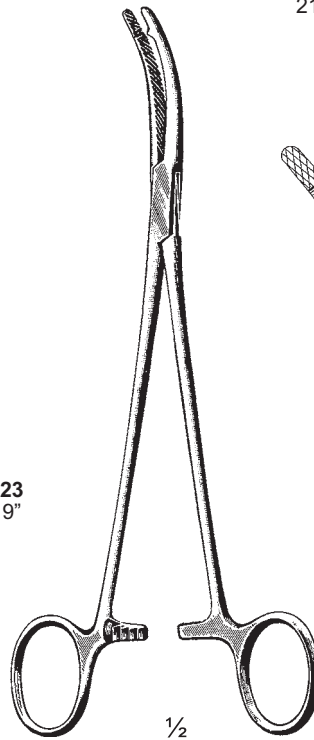

$\frac{1}{2}$

Heaney  
 192-07-19 To 192-09-23

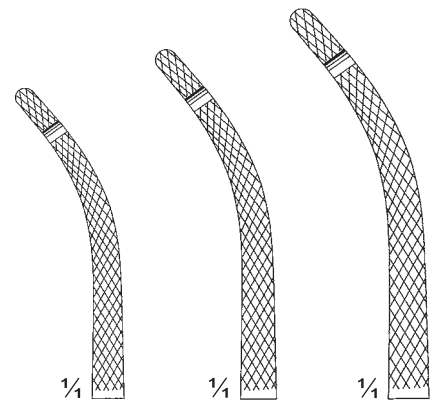

$\frac{1}{4}$

$\frac{1}{4}$

$\frac{1}{4}$

192-07-19 192-08-21 192-09-23  
 19.5 cm / 7 $\frac{3}{4}$ " 21 cm / 8 $\frac{1}{4}$ " 23 cm / 9"

**Hysterektomieklemmen  
Hysterectomy Forceps  
Pincès à hystérectomie**

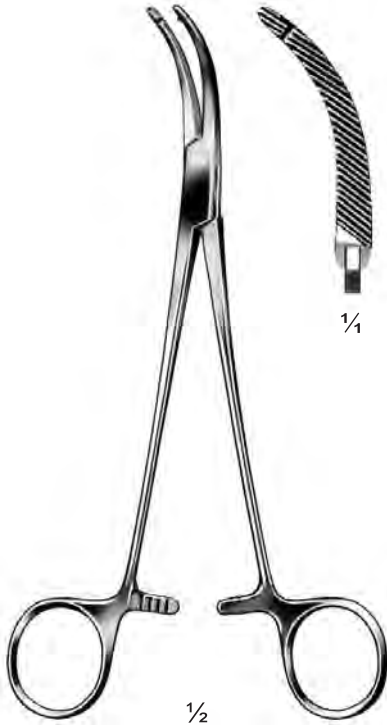

Walzl  
193-01-19  
19 cm / 7½"



Ballentine  
193-02-21  
21 cm / 8¼"

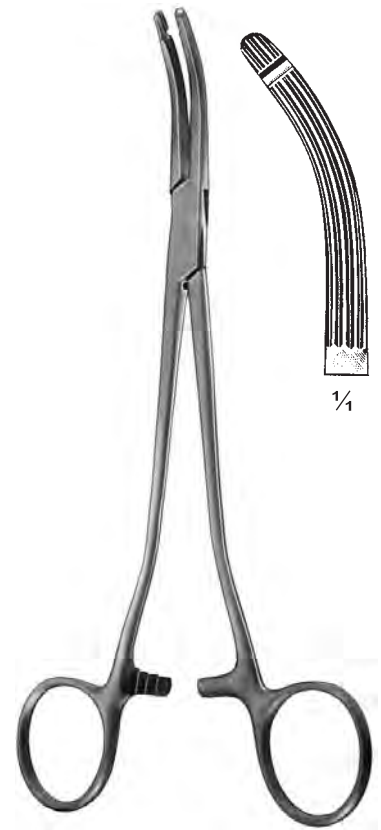

Heaney-Ballentine  
193-03-21  
21 cm / 8¼"

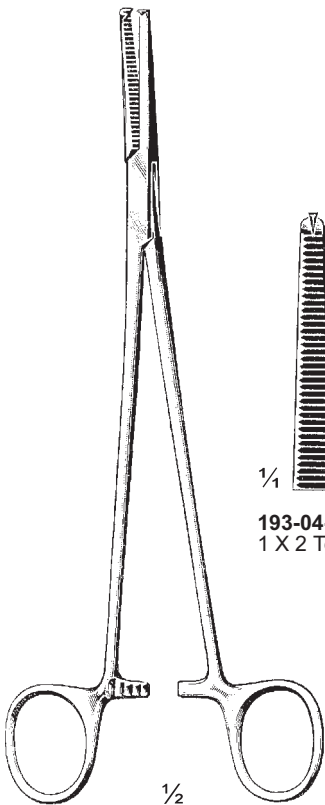

Phaneuf  
193-04-21 To 193-06-21  
21.5 cm / 8½"



193-04-21  
1 X 2 Teeth



193-05-21  
1 X 2 Teeth

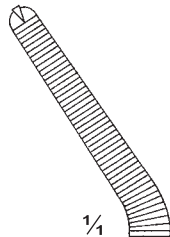

193-06-21  
1 X 2 Teeth

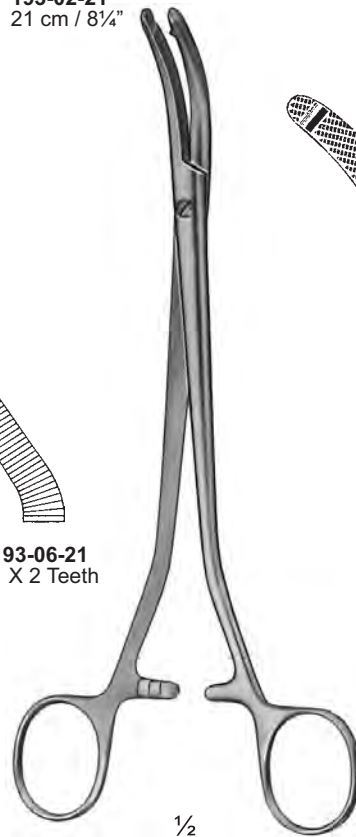

Wiener Model  
193-07-18 To 193-11-24

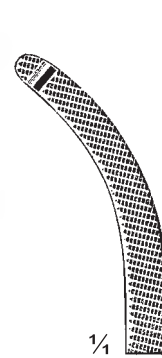

193-07-18  
18.5 cm / 7¼"

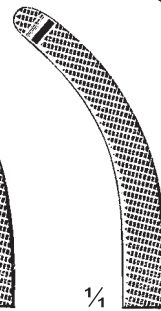

193-08-22  
22 cm / 8¾"

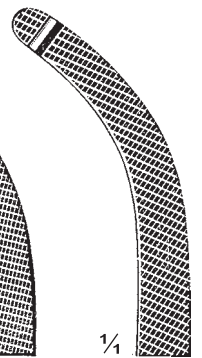

193-09-25  
25 cm / 10"



193-10-22  
22 cm / 8¾"



193-11-24  
24 cm / 9½"

**Hysterektomieklemmen  
Hysterectomy Forceps  
Pincès à hystérectomie**

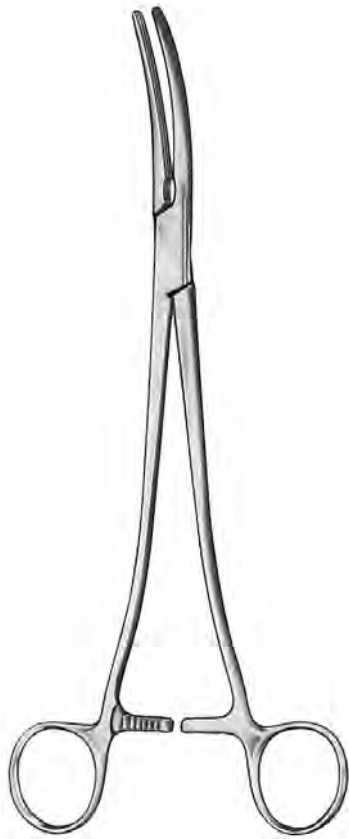

Heaney-Glassman  
194-01-22 To 194-04-20

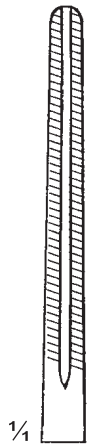

194-01-22  
22 cm / 8<sup>3</sup>/<sub>4</sub>"

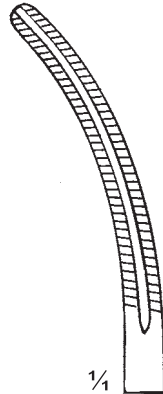

194-02-22  
22 cm / 8<sup>3</sup>/<sub>4</sub>"

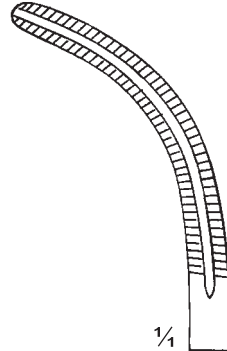

194-03-22  
22 cm / 8<sup>3</sup>/<sub>4</sub>"

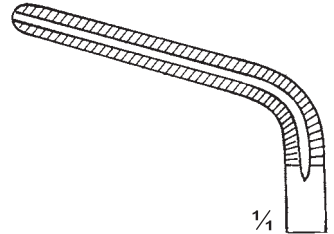

194-04-20  
20 cm / 8"

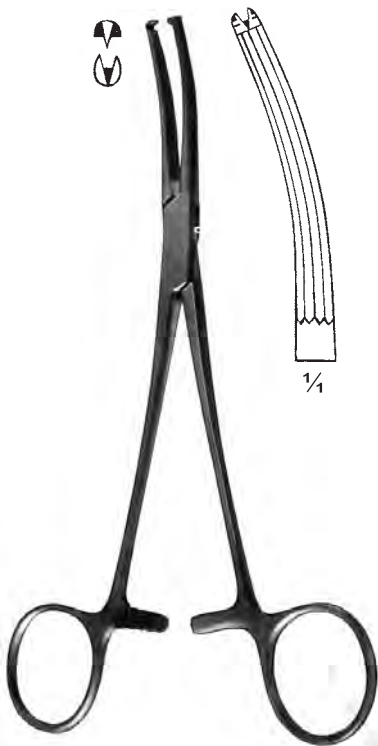

Long  
194-05-19  
19 cm / 7<sup>1</sup>/<sub>2</sub>"  
1 X 2 Teeth



194-06-20  
20 cm / 8"

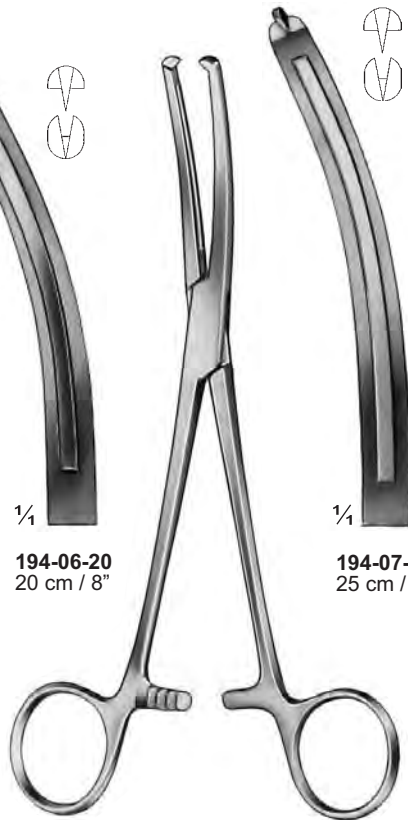

Maingot  
194-06-20 & 194-07-25  
1 X 2 Teeth



194-07-25  
25 cm / 10"

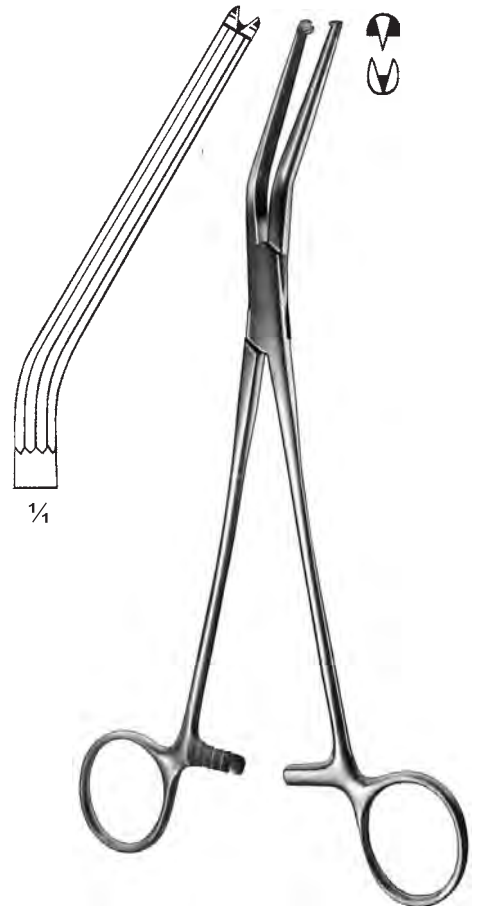

Kuffler  
194-08-23  
23 cm / 9"  
1 X 2 Teeth

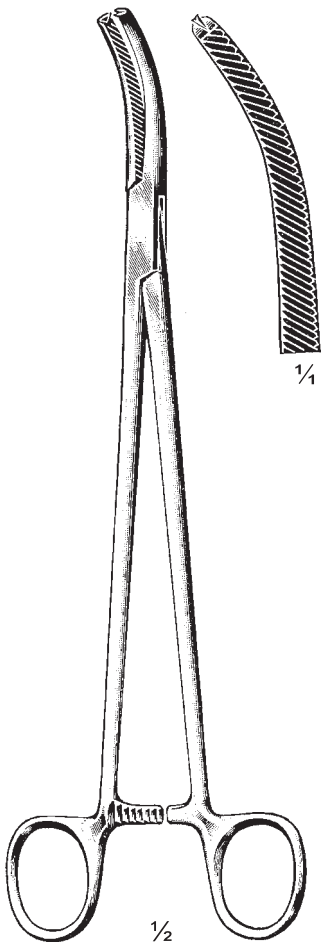

Wertheim  
195-01-24  
24.5 cm / 9<sup>3</sup>/<sub>4</sub>"  
1 X 2 Teeth

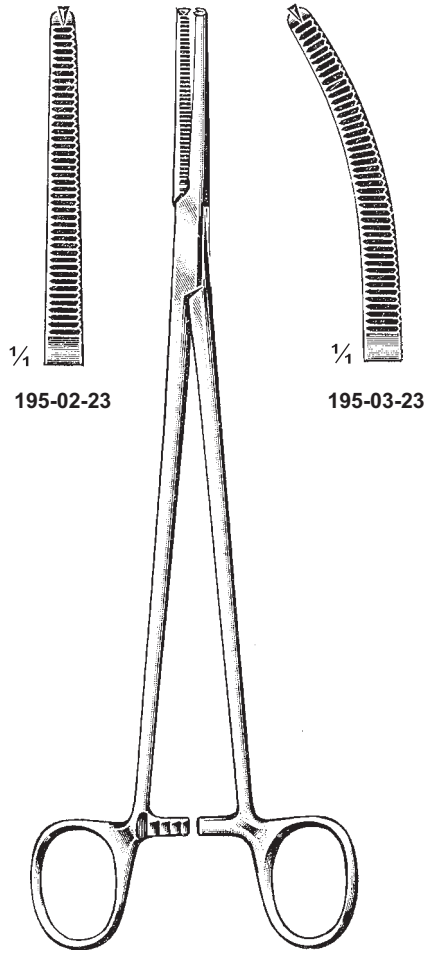

195-02-23

195-03-23

Holzbach  
195-02-23 & 195-03-23  
23.5 cm / 9<sup>1</sup>/<sub>4</sub>"  
1 X 2 Teeth

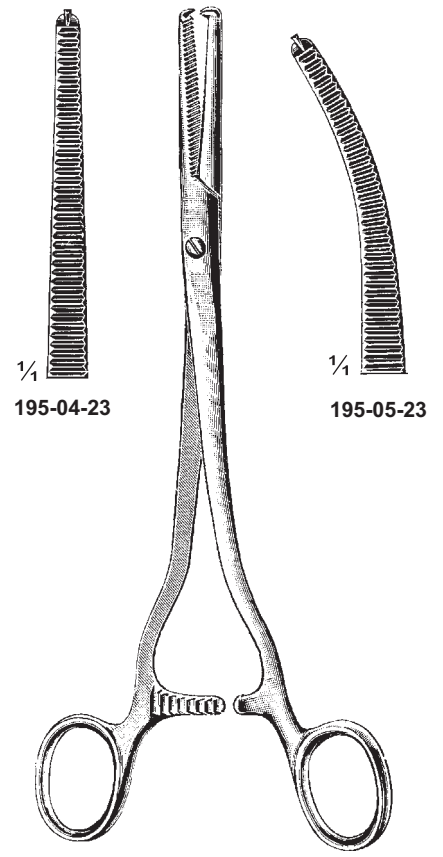

195-04-23

195-05-23

Holzbach  
195-04-23 & 195-05-23  
23.5 cm / 9<sup>1</sup>/<sub>4</sub>"  
1 X 2 Teeth

Hysterektomieklemmen  
Hysterectomy Forceps  
Pincès à hystérectomie

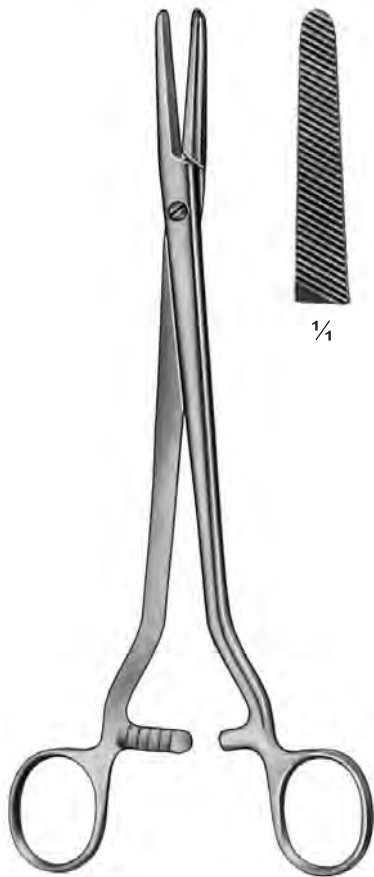

Segond-Landau  
196-01-24  
24 cm / 9½"

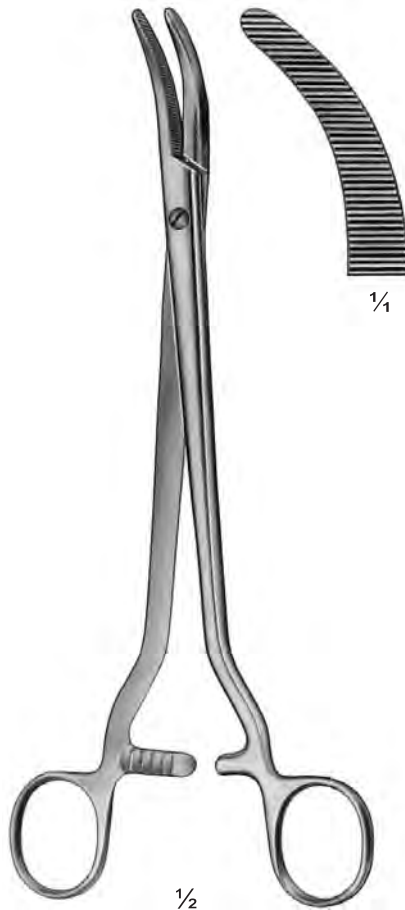

Segond  
196-02-24  
24 cm / 9½"



196-03-23

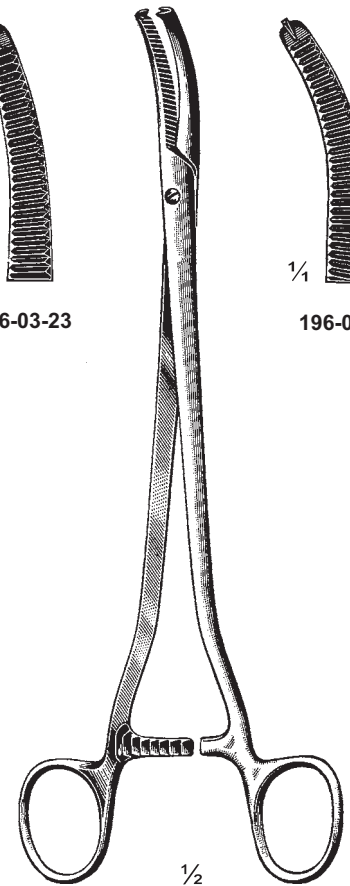

Wertheim  
196-03-23 & 196-04-23  
23.5 cm / 9¼"  
1 X 2 Teeth



**Hysterektomieklemmen  
Hysterectomy Forceps  
Pincès à hystérectomie**

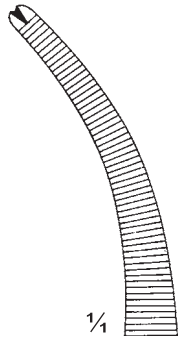

1/4  
197-01-23

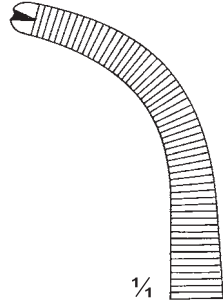

1/4  
197-02-23

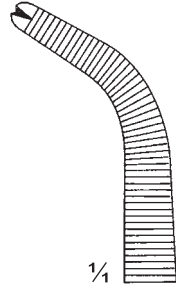

1/4  
197-03-23

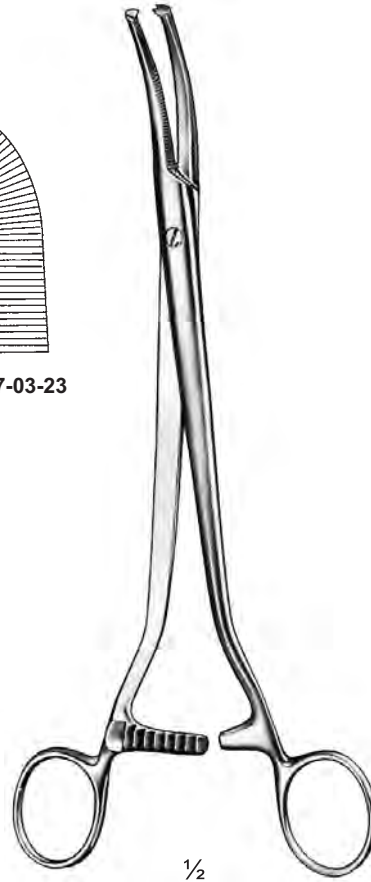

1/2  
Werheim  
197-01-23 To 197-03-23  
23 cm / 9"  
1 X 2 Teeth

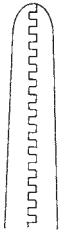

1/4

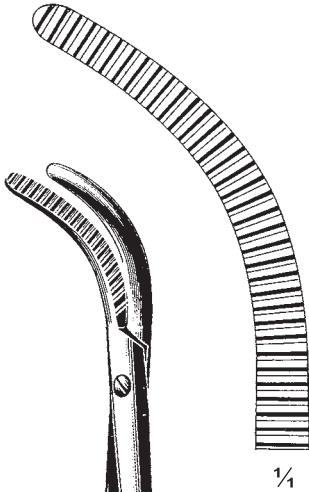

1/4

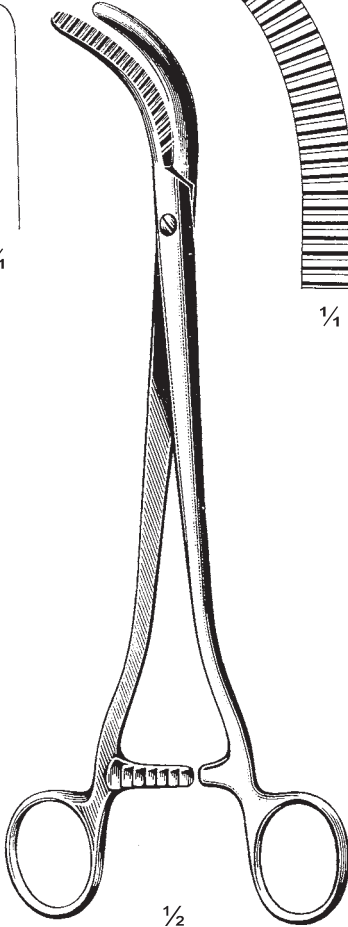

1/2  
Werheim  
197-04-25  
25 cm / 10"

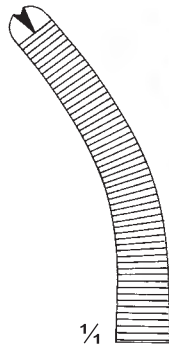

1/4

Extra strong

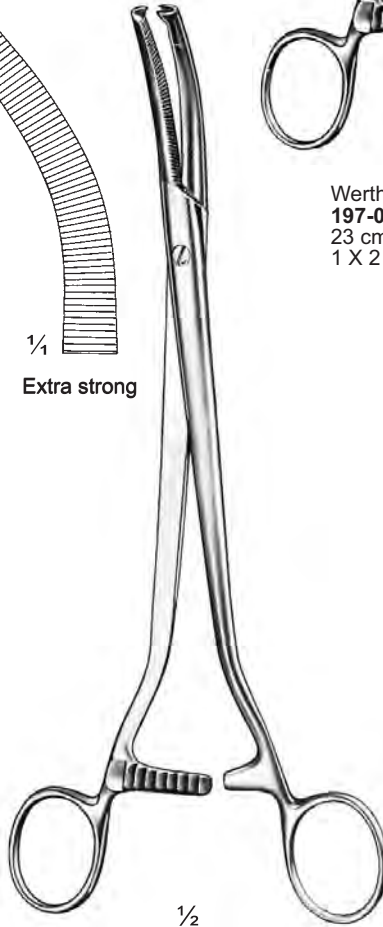

1/2  
Werheim  
197-05-24  
24 cm / 9 1/2"  
1 x 2 Teeth

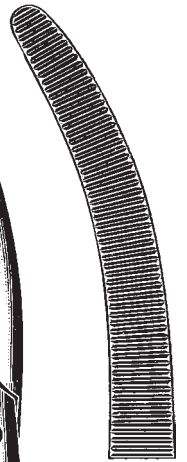

1/4

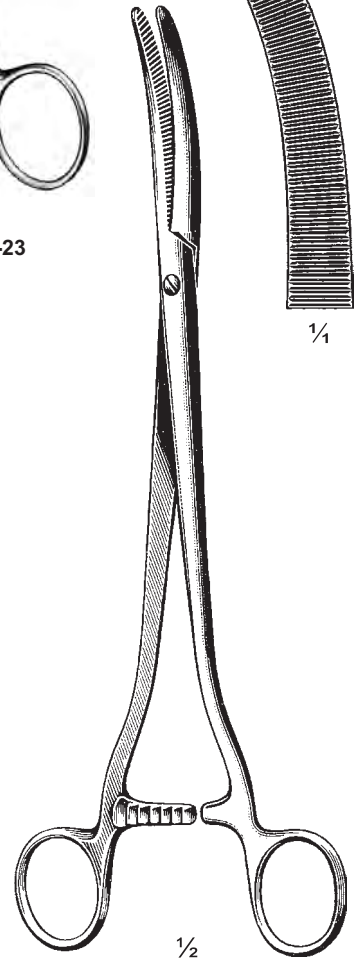

1/2  
Faure  
197-06-25  
25 cm / 10"

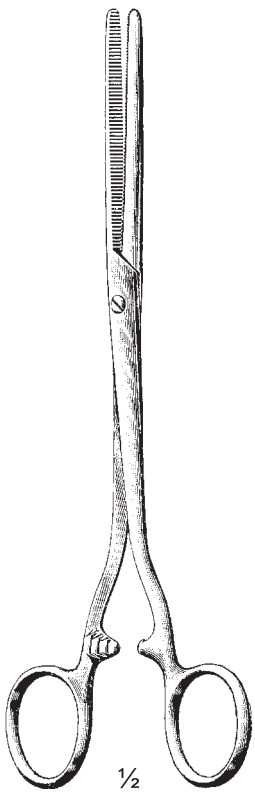

Ethridge  
198-01-22 22 cm / 8<sup>3</sup>/<sub>4</sub>" Str  
198-02-22 22 cm / 8<sup>3</sup>/<sub>4</sub>" Cur

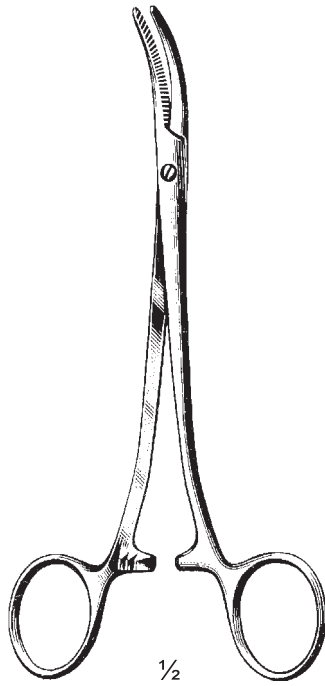

Wertheim  
198-03-18  
18 cm / 7"

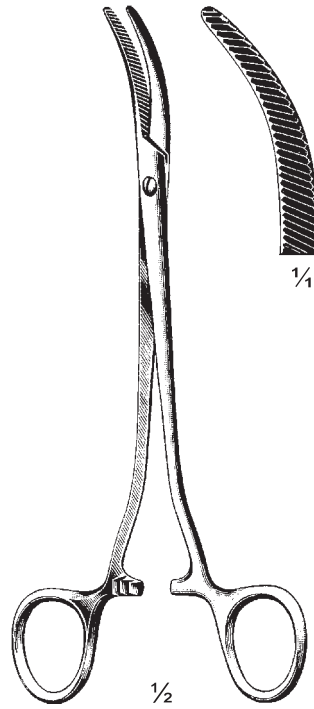

Wertheim  
198-04-18  
18.5 cm / 7<sup>1</sup>/<sub>4</sub>"

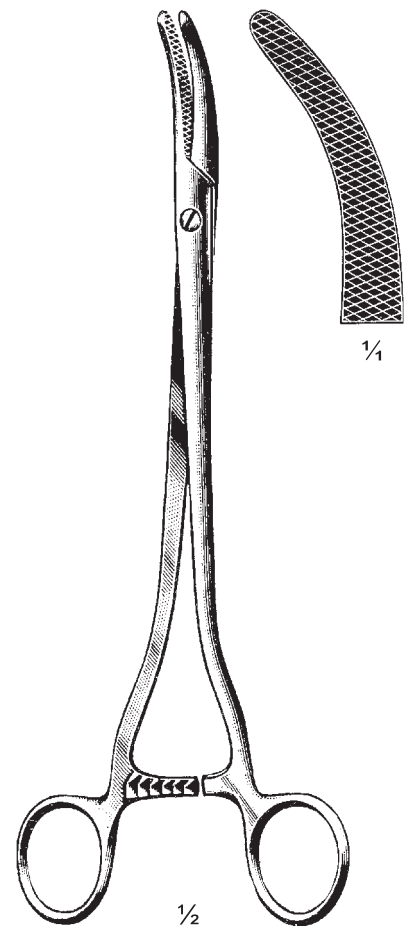

Wertheim  
198-05-25  
25 cm / 10"

**Hysterektomieklemmen**  
**Hysterectomy Forceps**  
**Pinces à hystérectomie**

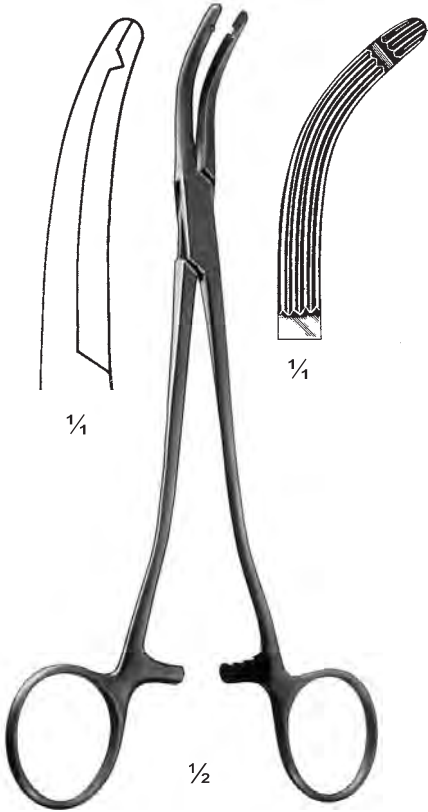

Glenner  
**199-01-21**  
 21 cm / 8<sup>1</sup>/<sub>4</sub>"

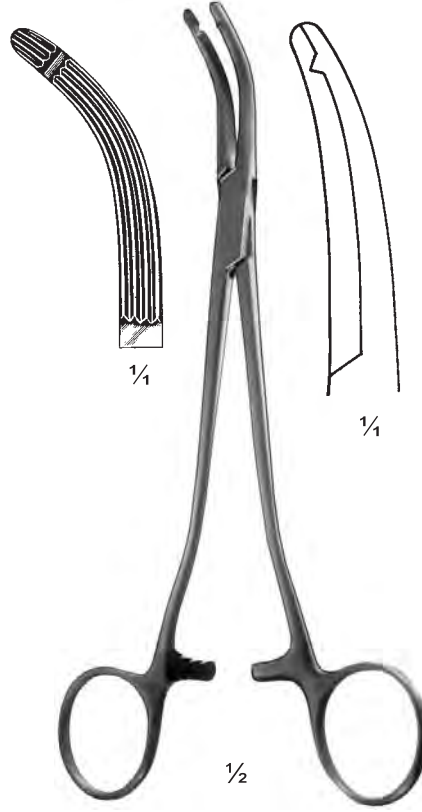

Glenner  
**199-02-21**  
 21 cm / 8<sup>1</sup>/<sub>4</sub>"



**199-03-22**  
 22 cm / 8<sup>3</sup>/<sub>4</sub>"



**199-04-23**  
 23 cm / 9"

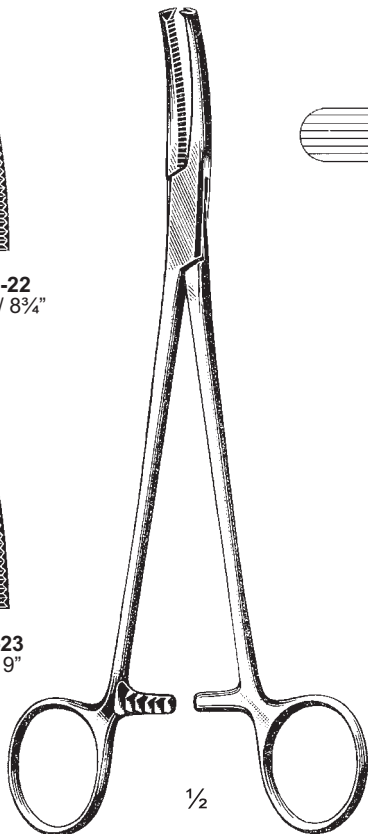

Wertheim  
**199-03-22 & 199-04-23**  
 1 X 2 Teeth

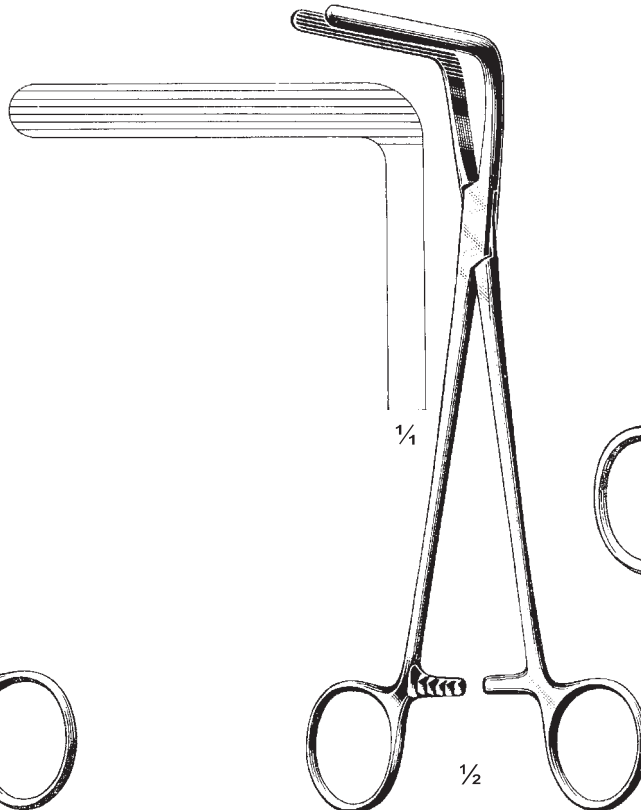

Wertheim-Cullen  
**199-05-21**  
 21.5 cm / 8<sup>1</sup>/<sub>2</sub>"

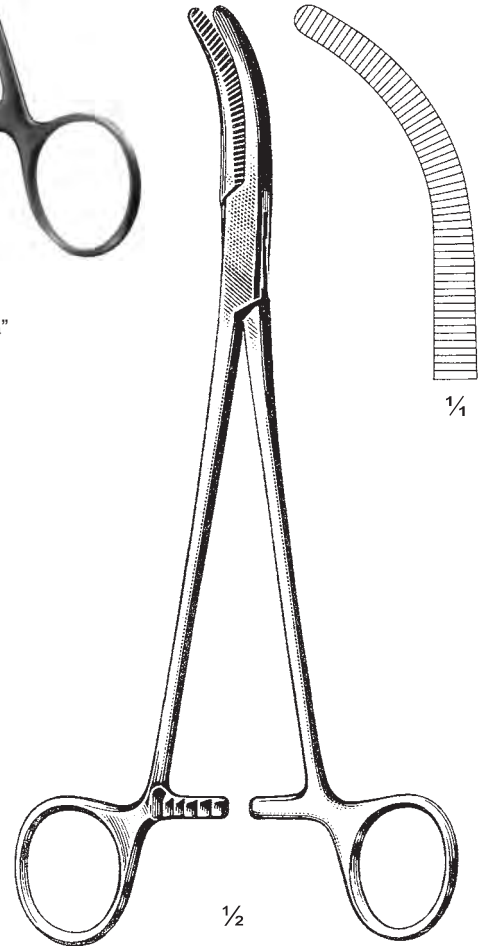

Wertheim  
**199-06-25**  
 25 cm / 10"

**Hysterektomieklemmen  
Hysterectomy Forceps  
Pincès à hystérectomie**



$\frac{1}{2}$   
Zweifel  
200-01-18  
18 cm / 7"  
Compression forceps

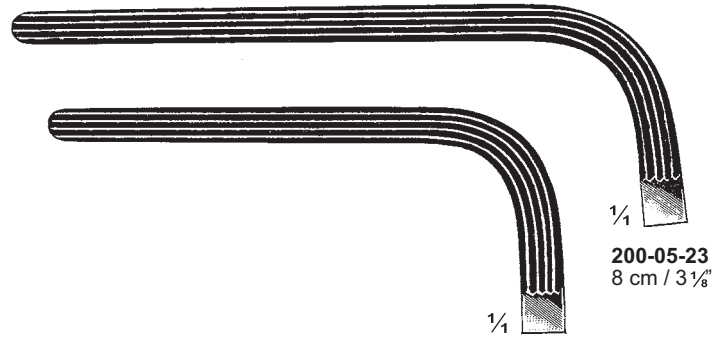

$\frac{1}{4}$   
200-05-23  
8 cm / 3 1/8"  
 $\frac{1}{4}$   
200-04-23  
6 cm / 2 1/4"

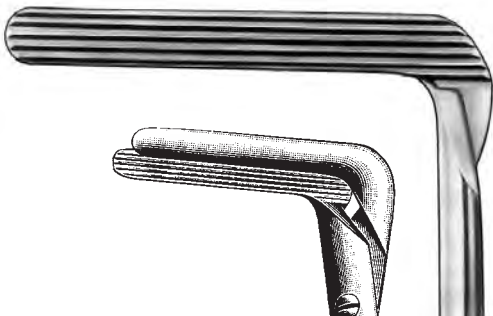

$\frac{1}{4}$

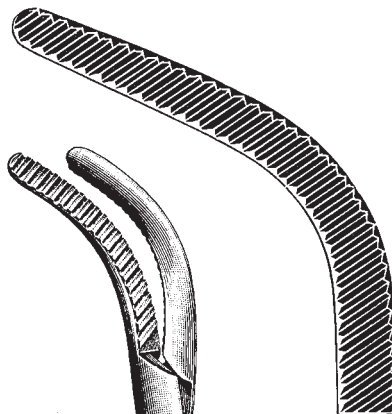

$\frac{1}{4}$

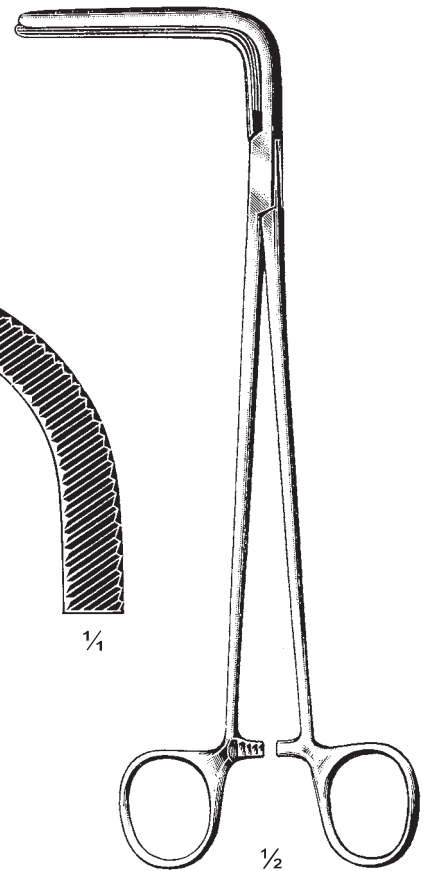

$\frac{1}{2}$   
200-04-23 & 200-05-23  
23 cm / 9"

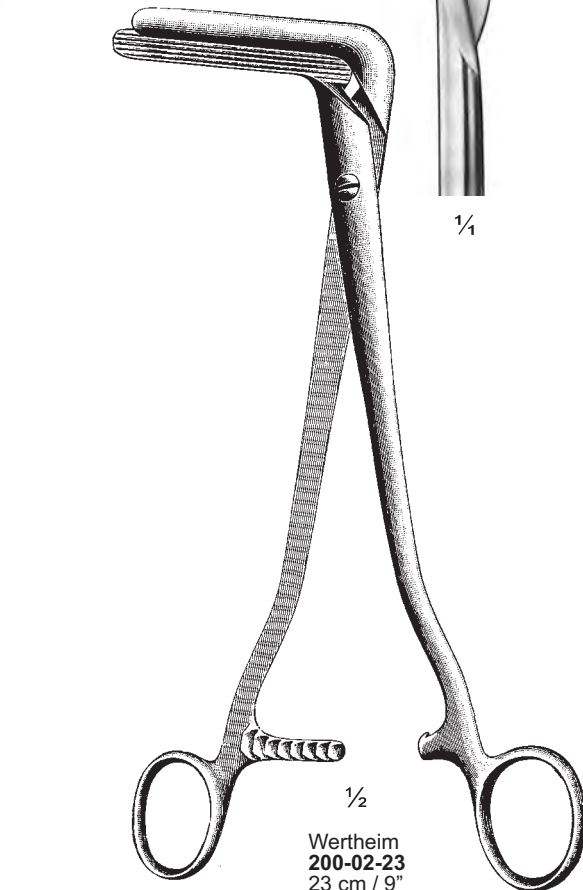

$\frac{1}{2}$   
Wertheim  
200-02-23  
23 cm / 9"

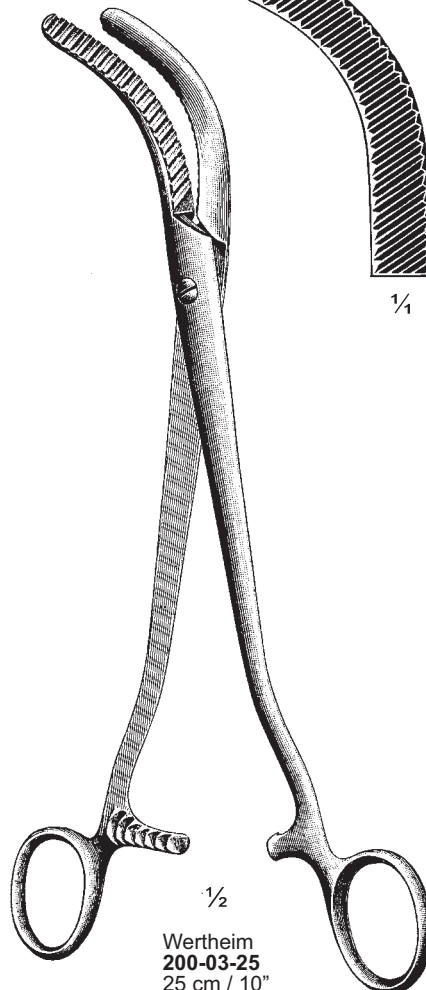

$\frac{1}{2}$   
Wertheim  
200-03-25  
25 cm / 10"

# Hysterektomieklemmen Hysterectomy Forceps Pincès à hystérectomie



1/2

Rogers  
201-01-22 To 201-09-23

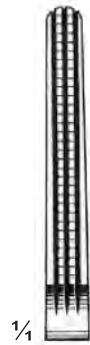

201-01-22  
22 cm / 8 3/4"



201-02-21  
21.5 cm / 8 1/2"



201-03-21  
21 cm / 8 1/4"



201-04-20  
20 cm / 8"



201-05-20  
20 cm / 8"

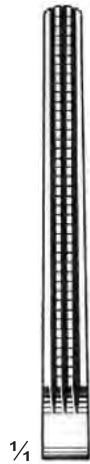

201-06-25  
25 cm / 10"



201-07-25  
25 cm / 10"



201-08-24  
24.5 cm / 9 3/4"



201-09-23  
23 cm / 9"



201-10-23  
23 cm / 9"



201-11-24  
24 cm / 9 1/2"

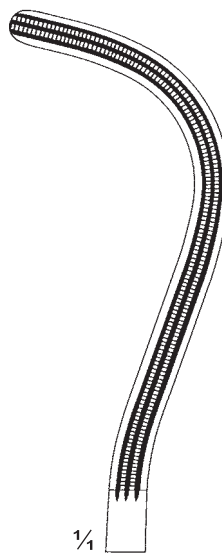

201-12-23  
23 cm / 9"

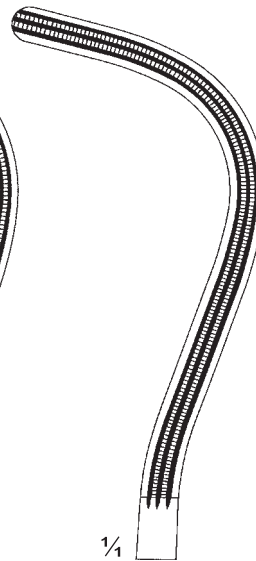

201-13-24  
24 cm / 9 1/2"



1/2

Guyon  
201-10-23 To 201-13-24



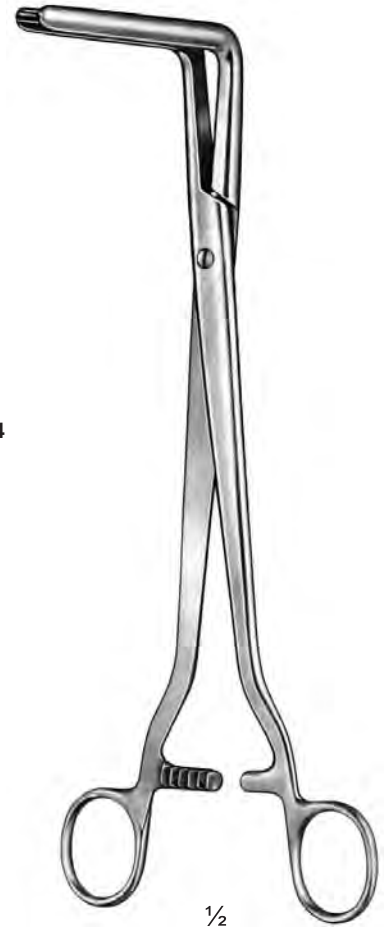
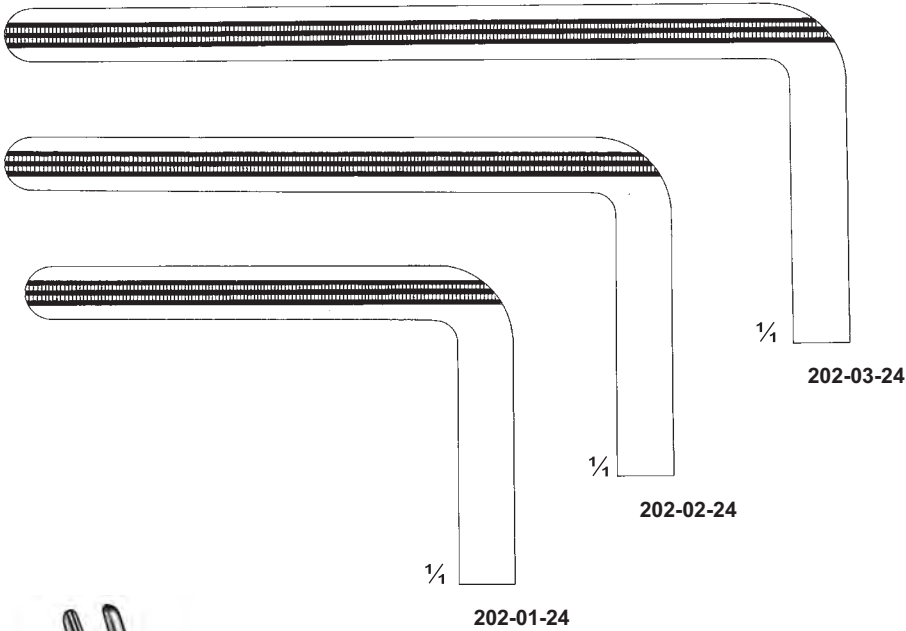

Wertheim  
202-01-24 To 202-03-24  
24 cm / 9 1/2"

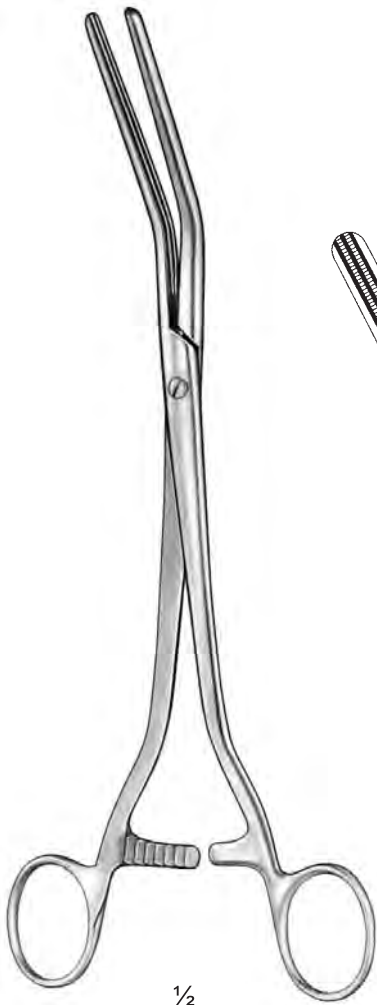

Dick  
202-04-25 To 202-06-27

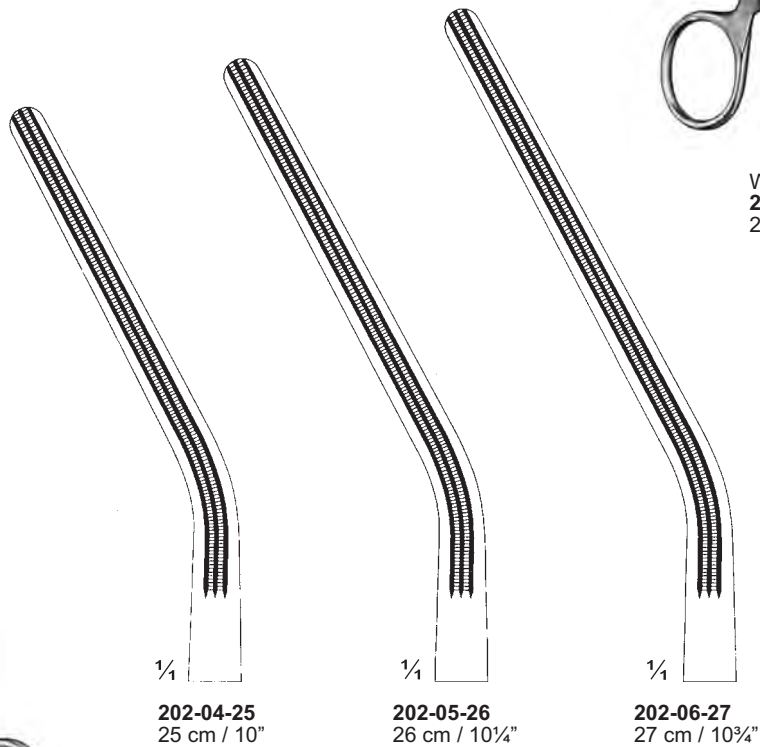



**Hysterektomieklemmen**  
**Hysterectomy Forceps**  
**Pinces à hystérectomie**

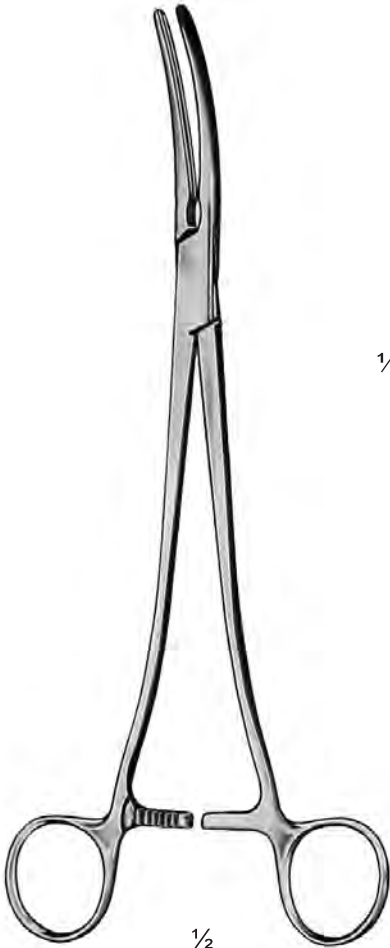

$\frac{1}{2}$   
 Wertheim  
 203-01-25 To 203-04-23

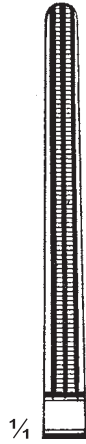

$\frac{1}{4}$   
 203-01-25  
 25 cm / 10"

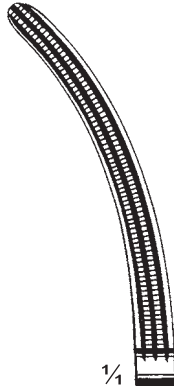

$\frac{1}{4}$   
 203-02-24  
 24.5 cm / 9 $\frac{3}{4}$ "

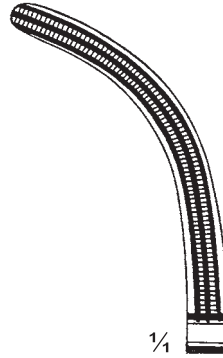

$\frac{1}{4}$   
 203-03-24  
 24 cm / 9 $\frac{1}{2}$ "

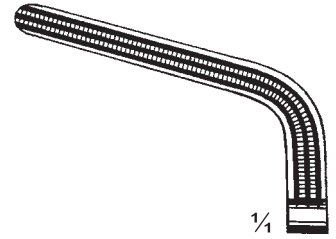

$\frac{1}{4}$   
 203-04-23  
 23 cm / 9"

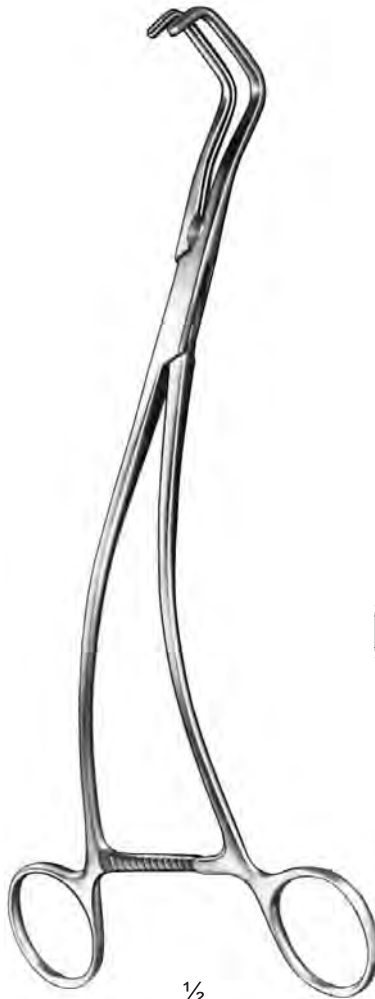

$\frac{1}{2}$   
 Uro-Tangential  
 203-05-26 & 203-06-26  
 26 cm / 10 $\frac{1}{4}$ "

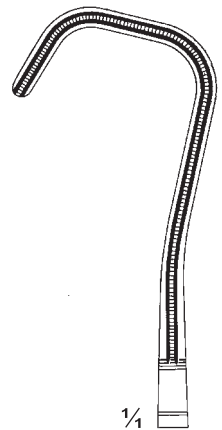

$\frac{1}{4}$   
 203-05-26

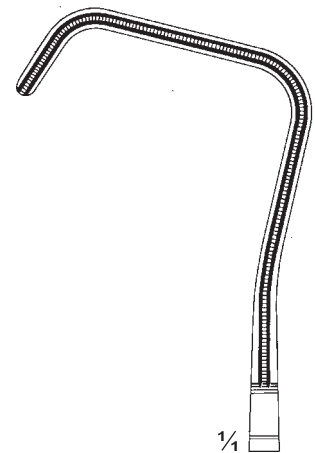

$\frac{1}{4}$   
 203-06-26

**Peritoneumklemmen**  
**Peritoneal Clamp Forceps**  
**Pince pour le péritoine**

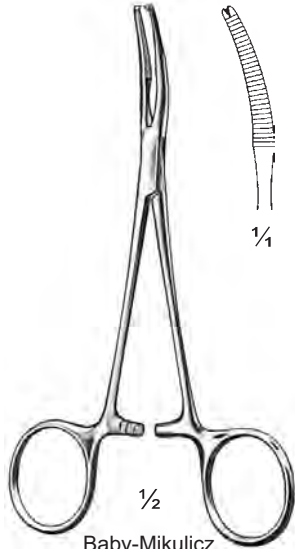

**Baby-Mikulicz**  
**204-01-14**  
 14 cm / 5½"  
 1 X 2 Teeth



**Mikulicz**  
**204-02-18**  
 18 cm / 7"  
 1 X 2 Teeth

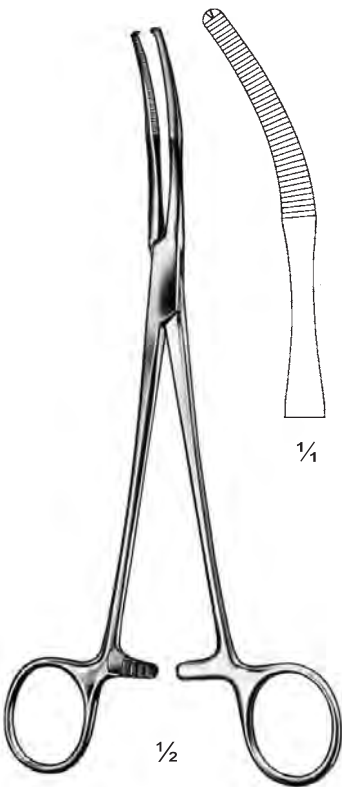

**Mikulicz**  
**204-03-20**  
 20 cm / 8"  
 1 X 2 Teeth

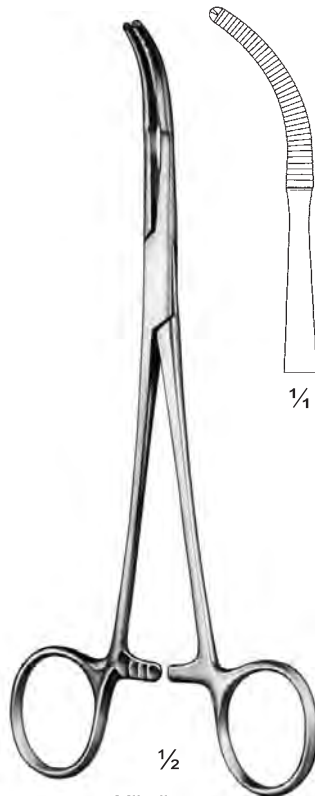

**Mikulicz**  
**204-04-20**  
 20 cm / 8"  
 1 X 2 Teeth



**Mikulicz**  
**204-05-18**  
 18.5 cm / 7¼"  
 1 X 2 Teeth

**Peritoneumklemmen**  
**Peritoneal Clamp Forceps**  
**Pince pour le péritoine**

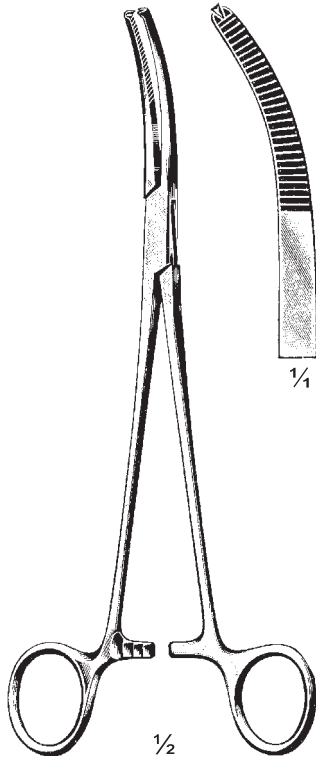

Mikulicz  
**205-01-20**  
 20 cm / 8"  
 1 X 2 Teeth

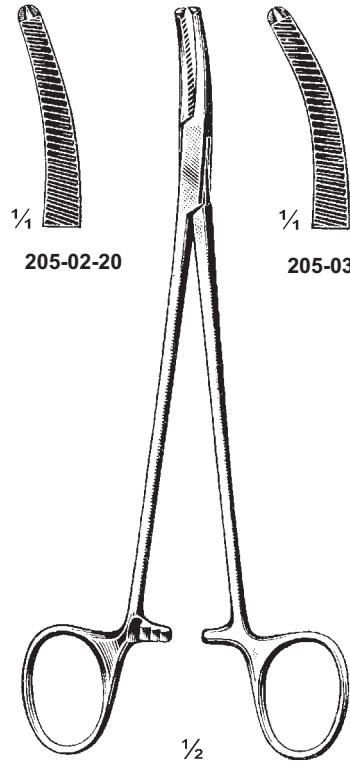

Faure  
**205-02-20 & 205-03-20**  
 20 cm / 8"  
 1 X 2 Teeth

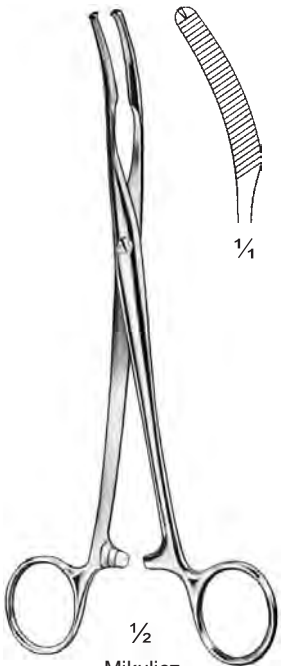

Mikulicz  
**205-04-18**  
 18 cm / 7"  
 1 X 2 Teeth

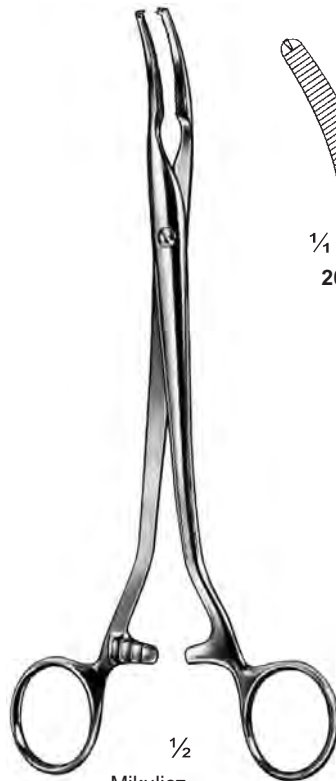

Mikulicz  
**205-05-20 & 205-06-20**  
 20 cm / 8"  
 1 X 2 Teeth

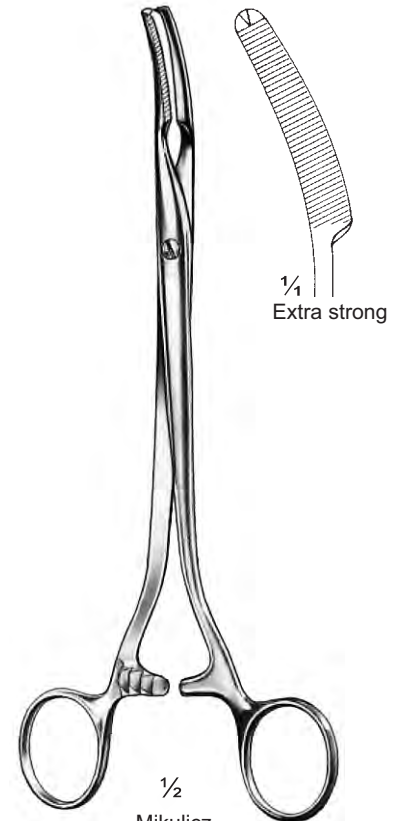

Mikulicz  
**205-07-20**  
 20 cm / 8"  
 1 X 2 Teeth

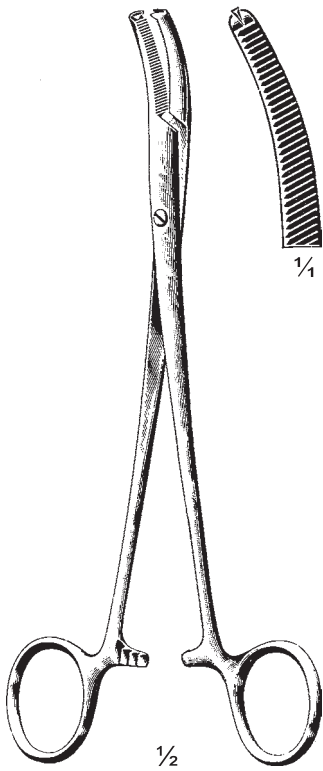

Mikulicz  
206-01-20  
20 cm / 8"  
1 X 2 Teeth

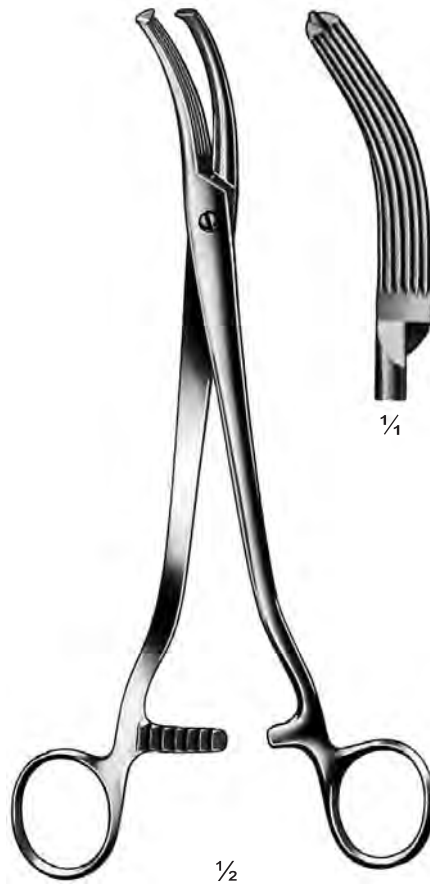

Mikulicz  
206-02-23  
23 cm / 9"  
1 X 2 Teeth

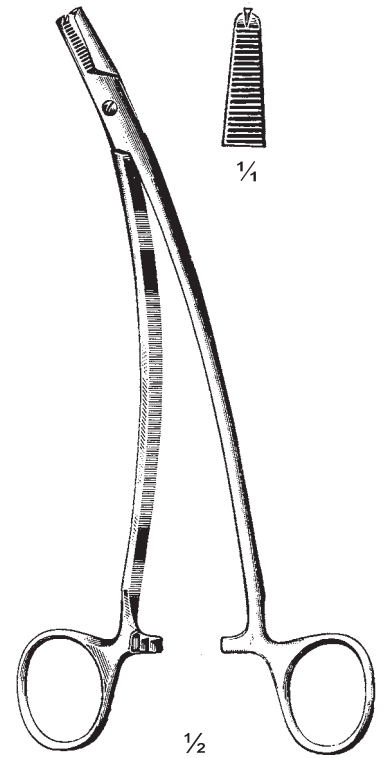

Schindler  
206-03-20  
20 cm / 8"  
1 X 2 Teeth



1/4

Dieffenbach  
**207-01-03** 3.5 cm / 1 3/8"  
**207-02-05** 5 cm / 2"  
**207-03-06** 6 cm / 2 3/8"  
**207-04-06** 6.5 cm / 2 1/2"  
**207-05-07** 7 cm / 2 3/4"  
**207-06-08** 8 cm / 3"



1/4

Dieffenbach  
**207-07-03** 3.5 cm / 1 3/8"  
**207-08-05** 5 cm / 2"  
**207-09-06** 6 cm / 2 3/8"  
**207-10-06** 6.5 cm / 2 1/2"  
**207-11-07** 7 cm / 2 3/4"  
**207-12-08** 8 cm / 3"



1/4

Dieffenbach  
**207-13-03** 3.5 cm / 1 3/8"  
**207-14-05** 5 cm / 2"  
**207-15-06** 6 cm / 2 3/8"  
**207-16-06** 6.5 cm / 2 1/2"  
**207-17-07** 7 cm / 2 3/4"  
**207-18-08** 8 cm / 3"



1/4

Dieffenbach  
**207-19-03** 3.5 cm / 1 3/8"  
**207-20-05** 5 cm / 2"  
**207-21-06** 6 cm / 2 3/8"  
**207-22-06** 6.5 cm / 2 1/2"  
**207-23-07** 7 cm / 2 3/4"  
**207-24-08** 8 cm / 3"



1/4

Johns-Hopkins  
**207-25-04** 4 cm / 1 1/2"  
**207-26-05** 5 cm / 2"  
**207-27-06** 6 cm / 2 3/8"  
**207-28-06** 6.5 cm / 2 1/2"  
**207-29-07** 7 cm / 2 3/4"  
**207-30-08** 8 cm / 3"  
**207-31-09** 9 cm / 3 1/2"



1/4

Johns-Hopkins  
**207-32-04** 4 cm / 1 1/2"  
**207-33-05** 5 cm / 2"  
**207-34-06** 6 cm / 2 3/8"  
**207-35-06** 6.5 cm / 2 1/2"  
**207-36-07** 7 cm / 2 3/4"  
**207-37-08** 8 cm / 3"  
**207-38-09** 9 cm / 3 1/2"



207-39-03



207-40-05

Johns-Hopkins  
**207-39-03** 3.8 cm / 1 1/2"  
**207-40-05** 5.1 cm / 2"



207-41-05



207-42-06

Johns-Hopkins  
**207-41-05** 5.7 cm / 2 1/4"  
**207-42-06** 6.3 cm / 2 1/2"



207-43-07



207-44-07

Johns-Hopkins  
**207-43-07** 7 cm / 2 3/4"  
**207-44-07** 7.6 cm / 3"



Johns-Hopkins  
**207-45-09** 9 cm / 3 1/2"



207-45-09



1/4

De Bakey  
**207-46-07** 7.5 cm / 3"  
**207-47-08** 8.5 cm / 3"  
**207-48-10** 10.5 cm / 4 1/8"  
**207-49-12** 12.5 cm / 5"



1/4

208-01-05 To 208-06-06



1/4

**208-01-05**  
5 cm / 2"  
8 mm Jaw

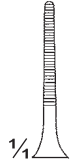

1/4

**208-02-05**  
5 cm / 2"  
12 mm Jaw

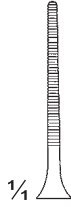

1/4

**208-03-06**  
6 cm / 2 3/8"  
20 mm Jaw



1/4

**208-04-05**  
5 cm / 2"  
8 mm Jaw

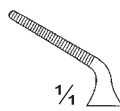

1/4

**208-05-05**  
5 cm / 2"  
12 mm Jaw

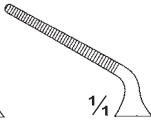

1/4

**208-06-06**  
6 cm / 2 3/8"  
20 mm Jaw



1/4

Micro-Coron  
**208-07-05** 5 cm / 2" 8 mm Jaw  
**208-08-05** 5 cm / 2" 12 mm Jaw  
**208-09-06** 6 cm / 2 3/8" 16 mm Jaw



1/4

Micro-Coron  
**208-10-04** 4.5 cm / 1 3/4" 8 mm Jaw  
**208-11-04** 4.5 cm / 1 3/4" 12 mm Jaw  
**208-12-05** 5.5 cm / 2 1/4" 16 mm Jaw



1/2

Johns-Hopkins  
**208-27-24**  
24.5 cm / 9 3/4"  
For applying and  
removing bulldog clamps



1/4

Ultra-Micro  
**208-13-03** 3 cm / 1 1/4"  
**208-14-03** 3.5 cm / 1 3/8"  
**208-15-04** 4 cm / 1 1/2"  
**208-16-05** 5 cm / 2"



1/4

Ultra-Micro  
**208-17-03** 3 cm / 1 1/4"  
**208-18-03** 3.5 cm / 1 3/8"  
**208-19-04** 4 cm / 1 1/2"  
**208-20-05** 5 cm / 2"



1/4

Ultra-Micro  
**208-21-03** 3 cm / 1 1/4"  
**208-22-03** 3.5 cm / 1 3/8"  
**208-23-04** 4 cm / 1 1/2"  
**208-24-05** 5 cm / 2"



1/4

De Bakey-Hess  
**208-25-04**  
Length of  
jaw 20 mm  
4 cm / 1 1/2"



1/4

De Bakey-Hess  
**208-26-04**  
Length of  
jaw 30 mm  
4.5 cm / 1 3/4"



**Bulldogklemmen  
Bulldog Clamps  
Clamps Bulldog**

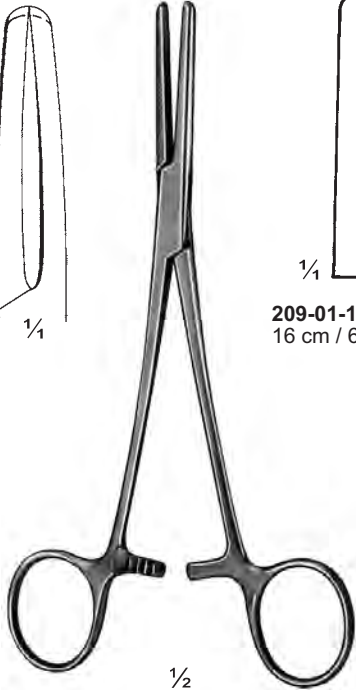

**209-01-16 To 209-0320**

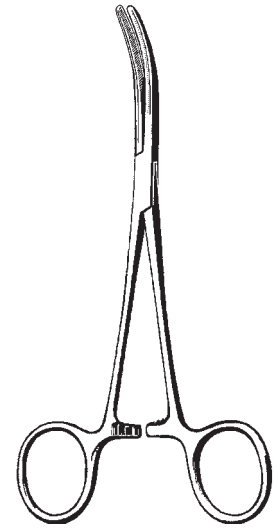

**St. Vincent**  
**209-04-16** 16 cm / 6 1/4"  
**209-05-18** 18 cm / 7"



**Standard**  
**209-06-15 To 209-08-20**

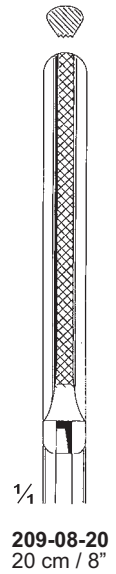
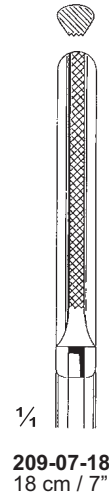
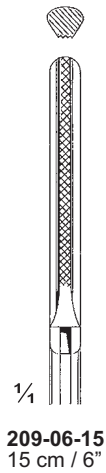

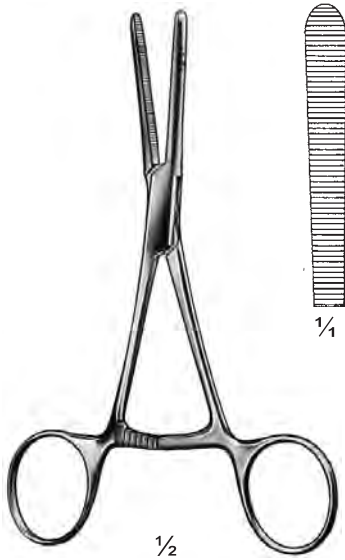

Mod. Klinikum-Berlin  
**210-01-14**  
14.5 cm / 5¾"

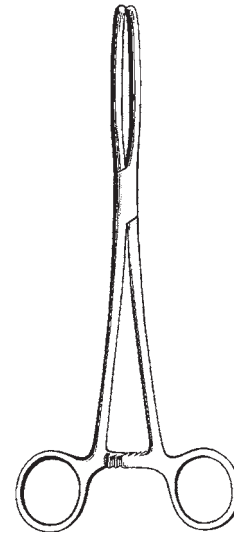

Marcuse  
**210-02-16** 16.5 cm / 6½"  
**210-03-20** 20 cm / 8"



**210-04-15 To 210-06-20**

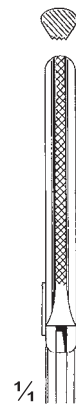

**210-04-15**  
15 cm / 6"

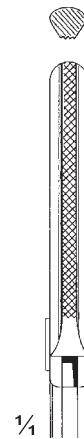

**210-05-18**  
18 cm / 7"

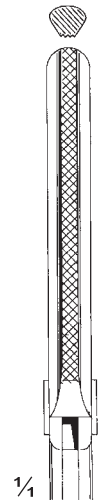

**210-06-20**  
20 cm / 8"

# Tuchklemmen Towel Forceps Pincès à champs

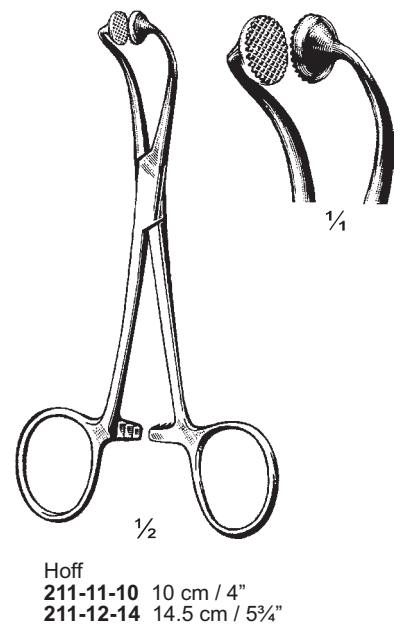
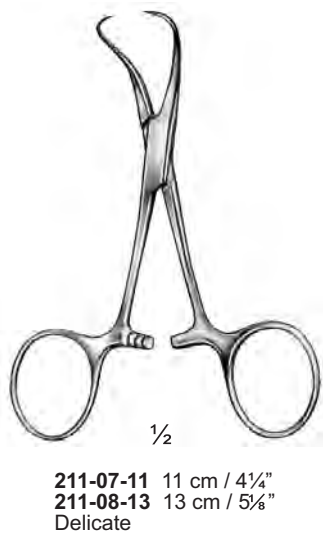
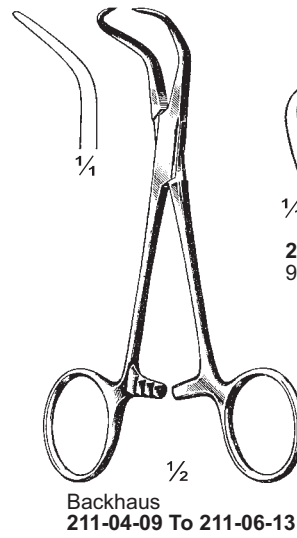
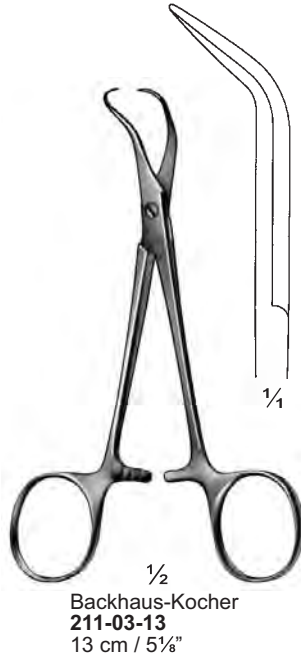
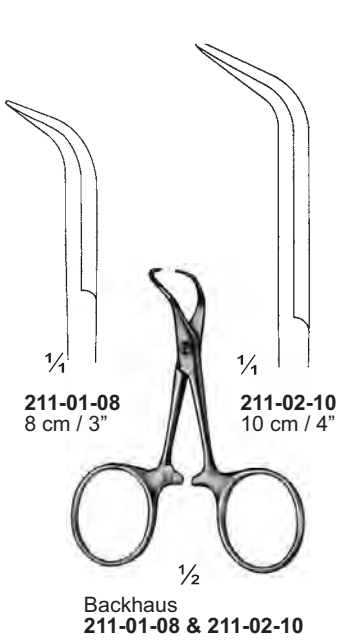

**Tuchklemmen  
Towel Forceps  
Pincès à champs**

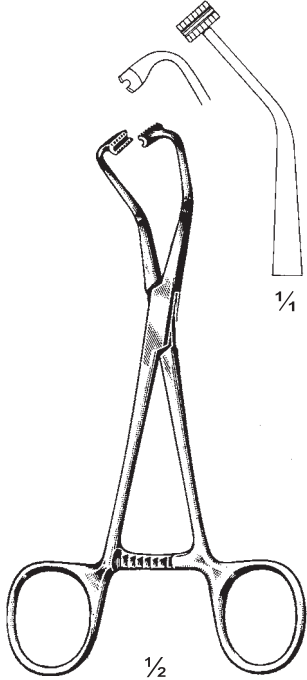

Peers-Bertram  
212-01-14  
14.5 cm / 5 3/4"

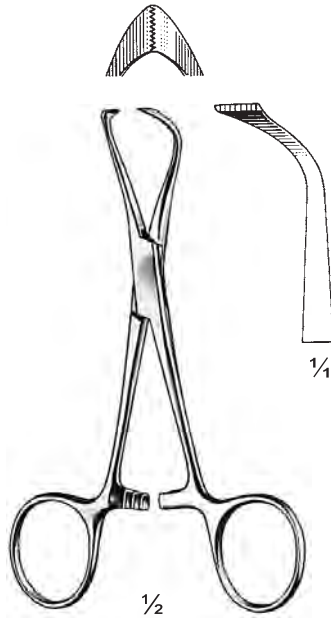

Lorna  
212-02-10 10 cm / 4"  
212-03-13 13 cm / 5 1/8"

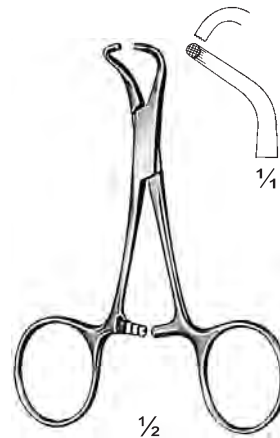

Tohoku  
212-04-10 10 cm / 4"  
212-05-13 13 cm / 5 1/8"

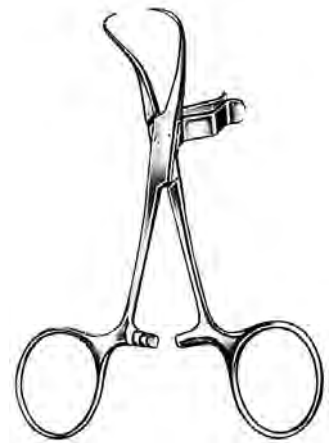

212-06-11  
11 cm / 4 1/4"

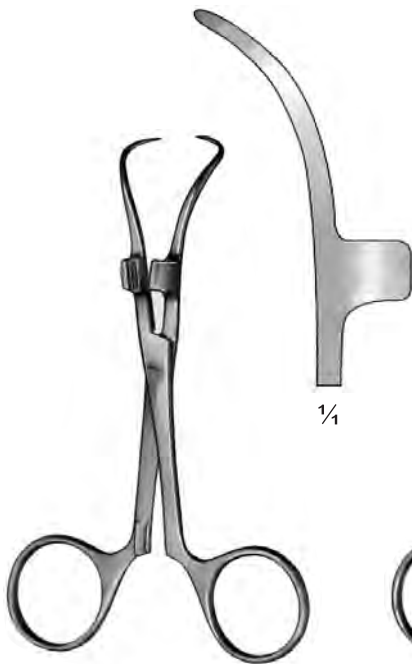

Robin  
212-07-13  
13.5 cm / 5 1/4"

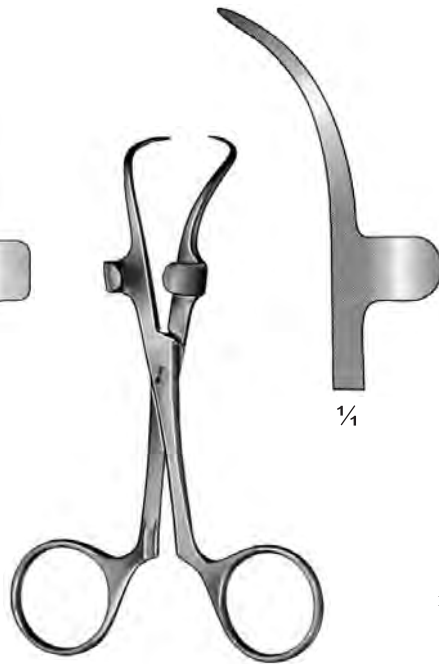

Robin  
212-08-13  
13.5 cm / 5 1/4"

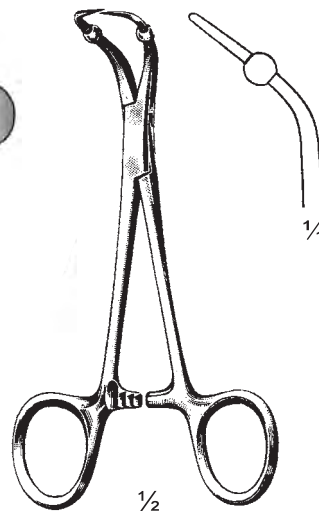

1/2  
Roeder  
212-09-13  
13.5 cm / 5 1/4"



Ombredanne (Jackson)  
212-10-13  
13.5 cm / 5 1/4"

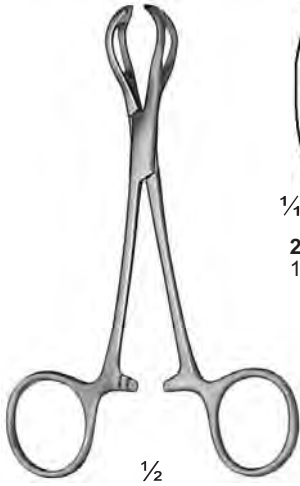

Lane  
213-01-13 To 213-03-19

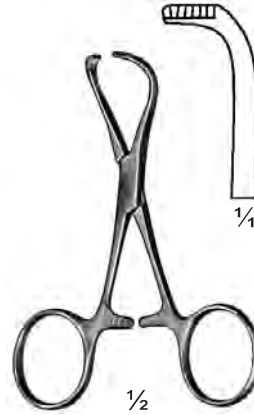
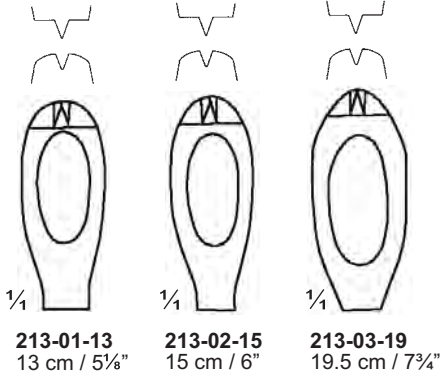

213-04-09  
9.5 cm / 3 3/4"

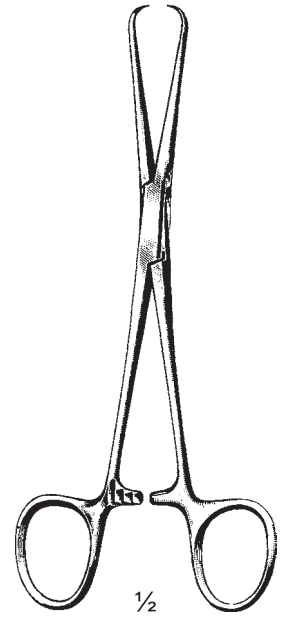

Bernhard  
213-05-16  
16 cm / 6 1/4"

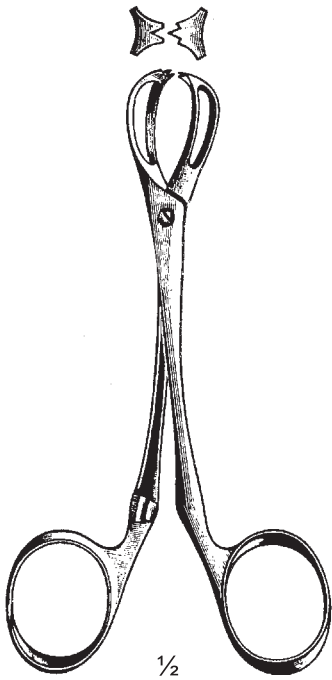

Lane  
213-06-13 13 cm / 5 1/8"  
213-07-15 15 cm / 6"  
1 X 2 Teeth

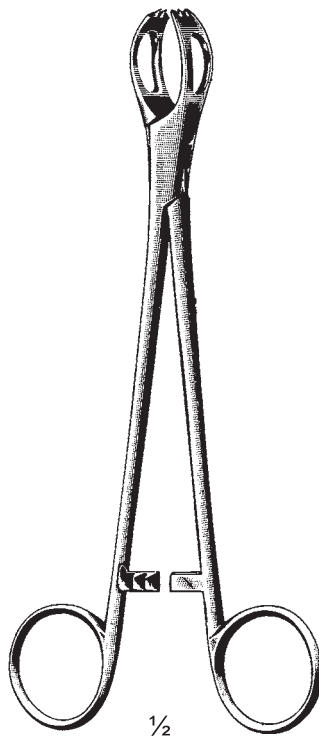

Lane  
213-08-15 15 cm / 6"  
213-09-18 18 cm / 7"  
213-10-20 20 cm / 8"  
2 X 3 Teeth

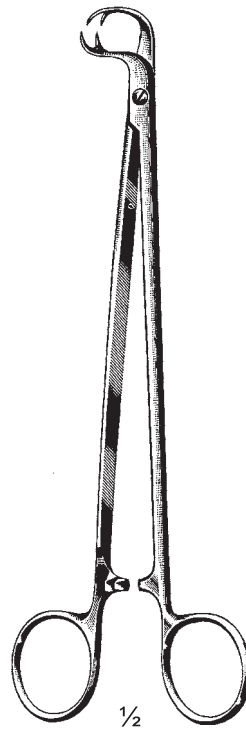

Moynihan  
213-11-19  
19 cm / 7 1/2"  
2 X 2 Teeth

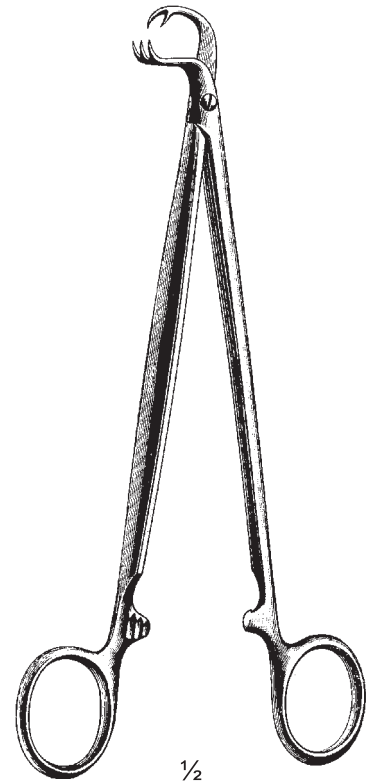

Moynihan  
213-12-17 17 cm / 6 3/4"  
213-13-19 19 cm / 7 1/2"  
2 X 3 Teeth

# Tuchklemmen Towel Forceps Pincers à champs

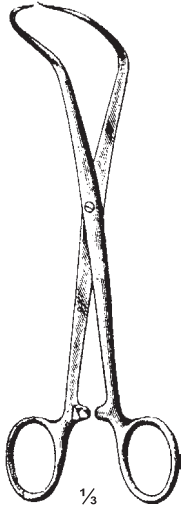

Schaedel  
214-01-19  
19.5 cm / 7<sup>3</sup>/<sub>4</sub>"



Jones  
214-02-05 5 cm / 2"  
214-03-09 9 cm / 3<sup>1</sup>/<sub>2</sub>"

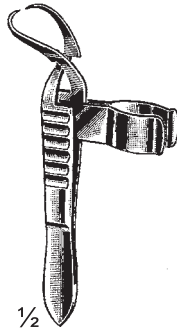

Jones  
214-04-09  
9 cm / 3<sup>1</sup>/<sub>2</sub>"  
With clip for tubing



Schaedel  
214-05-09 9 cm / 3<sup>1</sup>/<sub>2</sub>"  
214-06-10 10 cm / 4"



Schaedel  
214-07-09 9 cm / 3<sup>1</sup>/<sub>2</sub>"  
214-08-10 10 cm / 4"

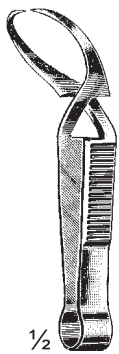

Engl. Model  
214-09-09 9 cm / 3<sup>1</sup>/<sub>2</sub>"  
214-10-10 10 cm / 4"

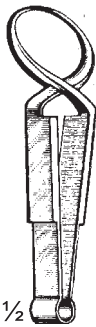

Engl. Model  
214-11-09 9 cm / 3<sup>1</sup>/<sub>2</sub>"  
214-12-10 10 cm / 4"

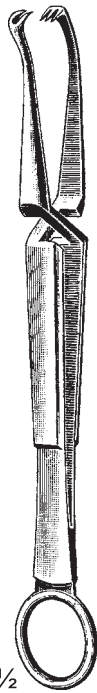

Doyen  
214-13-18  
18 cm / 7"  
2 X 3 Teeth



Doyen  
214-14-15 15 cm / 6"  
214-15-18 18 cm / 7"  
2 X 2 Teeth

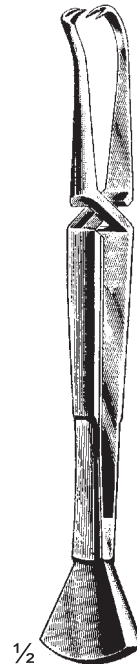

Doyen  
214-16-15 15 cm / 6"  
214-17-18 18 cm / 7"  
2 X 2 Teeth

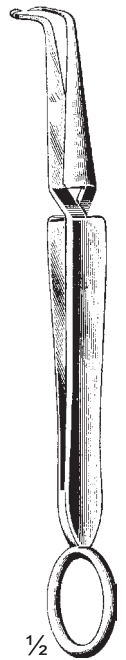

Doyen  
214-18-13 13.5 cm / 5<sup>1</sup>/<sub>4</sub>"  
214-19-16 16 cm / 6<sup>1</sup>/<sub>4</sub>"  
214-20-18 18 cm / 7"



# Tupferzangen Dressing Forceps Pincès à tampons

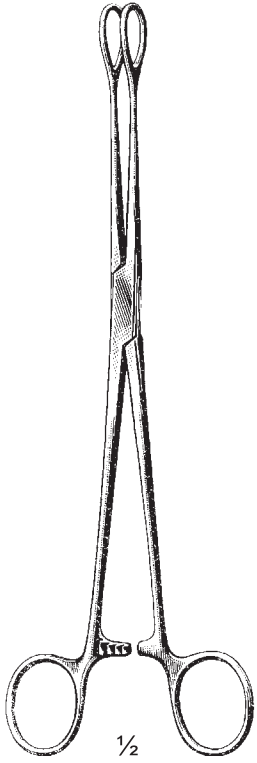

Foerster  
215-01-16 To 215-24-25



1/4

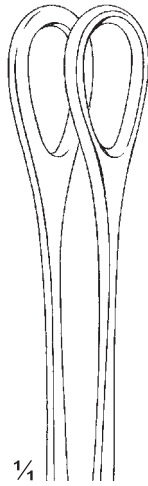

1/4

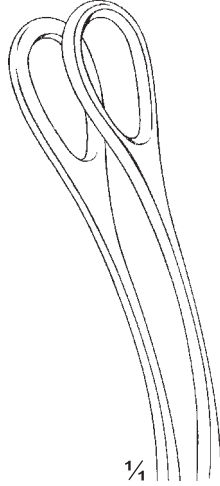

1/4

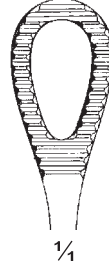

1/4

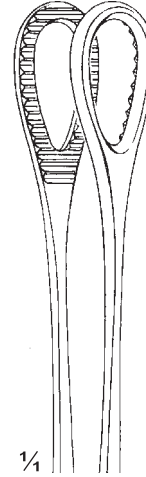

1/4

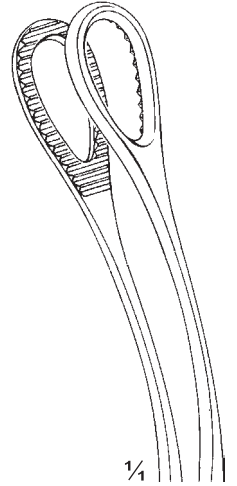

1/4

215-01-16 16 cm / 6 1/4"  
215-02-18 18 cm / 7"  
215-03-20 20 cm / 8"  
215-04-23 23 cm / 9"  
215-05-24 24 cm / 9 1/2"  
215-06-25 25 cm / 10"

215-07-16 16 cm / 6 1/4"  
215-08-18 18 cm / 7"  
215-09-20 20 cm / 8"  
215-10-23 23 cm / 9"  
215-11-24 24 cm / 9 1/2"  
215-12-25 25 cm / 10"

215-13-16 16 cm / 6 1/4"  
215-14-18 18 cm / 7"  
215-15-20 20 cm / 8"  
215-16-23 23 cm / 9"  
215-17-24 24 cm / 9 1/2"  
215-18-25 25 cm / 10"

215-19-16 16 cm / 6 1/4"  
215-20-18 18 cm / 7"  
215-21-20 20 cm / 8"  
215-22-23 23 cm / 9"  
215-23-24 24 cm / 9 1/2"  
215-24-25 25 cm / 10"

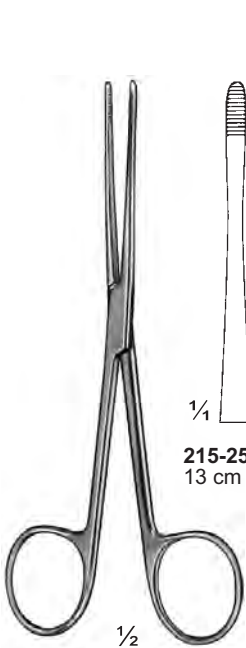

Lister  
215-25-13 To 215-27-18



1/4



1/4



1/4

215-25-13 13 cm / 5 1/8"  
215-26-15 15 cm / 6"  
215-27-18 18 cm / 7"

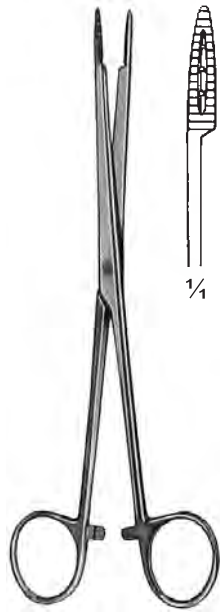

1/4

215-28-18  
18 cm / 7"



1/4

215-29-18  
18 cm / 7"

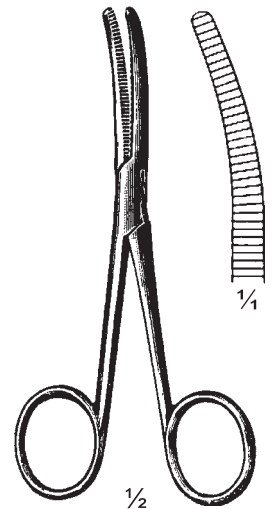

Bryant  
215-30-13  
13 cm / 5 1/8"

1/4

# Tupferzangen Dressing Forceps Pincès à tampons

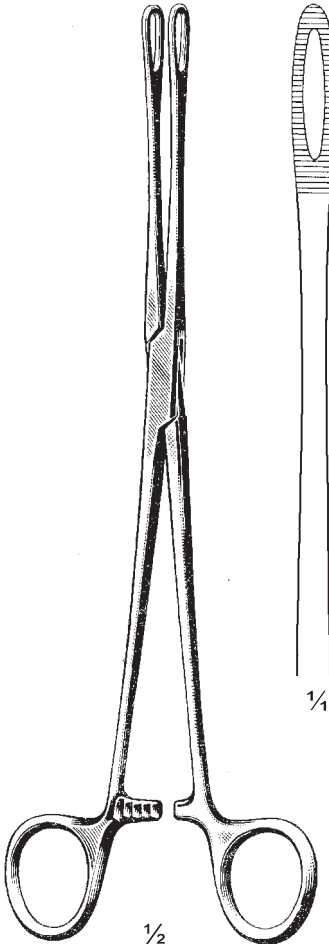

Foerster  
216-01-16 To 216-12-25



1/4

- 216-01-16 16 cm / 6 1/4"
- 216-02-18 18 cm / 7"
- 216-03-20 20 cm / 8"
- 216-04-23 23 cm / 9"
- 216-05-24 24 cm / 9 1/2"
- 216-06-25 25 cm / 10"

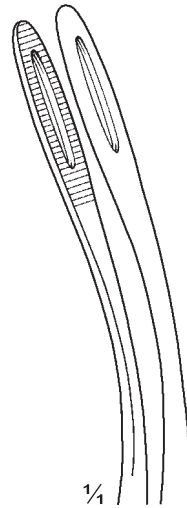

1/4

- 216-07-16 16 cm / 6 1/4"
- 216-08-18 18 cm / 7"
- 216-09-20 20 cm / 8"
- 216-10-23 23 cm / 9"
- 216-11-24 24 cm / 9 1/2"
- 216-12-25 25 cm / 10"

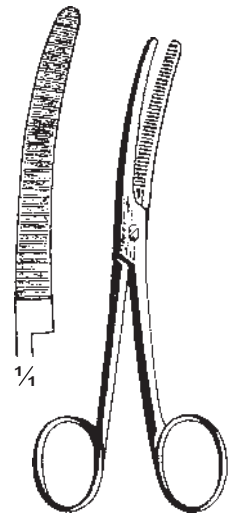

1/4

Bryant  
216-13-13  
13 cm / 5"



Gross  
216-14-14 To 216-21-20



1/4

- |                            |           |
|----------------------------|-----------|
| 216-14-14 14.5 cm / 5 3/4" | 216-18-14 |
| 216-15-16 16 cm / 6 1/4"   | 216-19-16 |
| 216-16-18 18 cm / 7"       | 216-20-18 |
| 216-17-20 20 cm / 8"       | 216-21-20 |



Gross  
216-22-14 To 216-29-20



1/4

- |                            |           |
|----------------------------|-----------|
| 216-22-14 14.5 cm / 5 3/4" | 216-26-14 |
| 216-23-16 16 cm / 6 1/4"   | 216-27-16 |
| 216-24-18 18 cm / 7"       | 216-28-18 |
| 216-25-20 20 cm / 8"       | 216-29-20 |

**Tupferzangen**  
**Dressing Forceps**  
**Pinces à tampons**

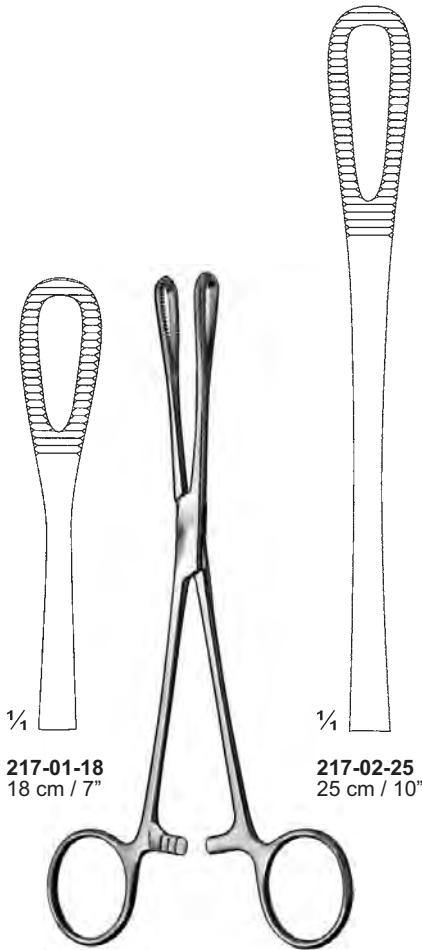

217-01-18  
18 cm / 7"

217-02-25  
25 cm / 10"

Ramley  
217-01-18 & 217-02-25

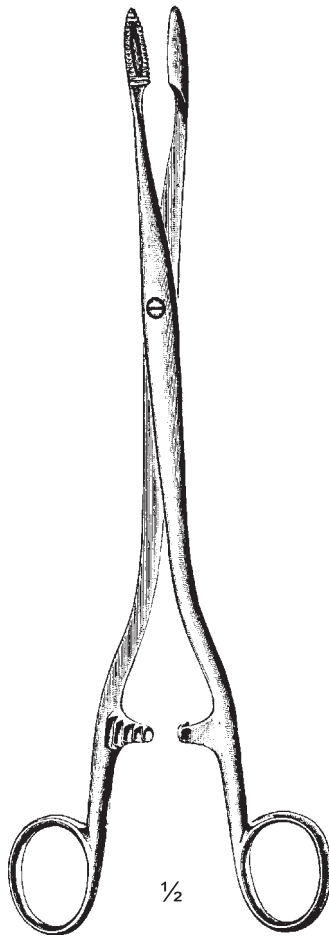

1/2

Duplay  
217-03-25 & 217-04-25  
25.5 cm / 10 1/8"

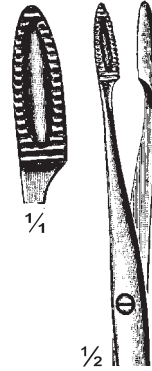

1/4

1/2

217-03-25

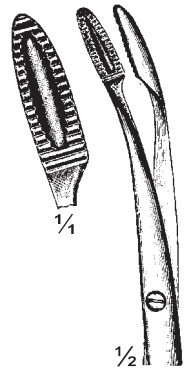

1/4

1/2

217-04-25

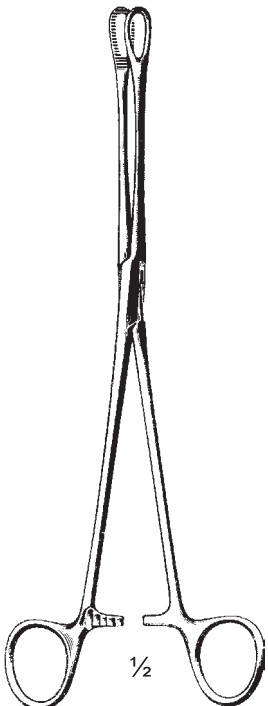

1/2

Foerster  
217-05-19 To 217-12-24



1/4

Str  
217-05-19 19 cm / 7 1/2"  
217-06-24 24 cm / 9 1/2"

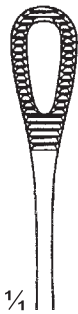

1/4

Str  
217-09-19 19 cm / 7 1/2"  
217-10-24 24 cm / 9 1/2"

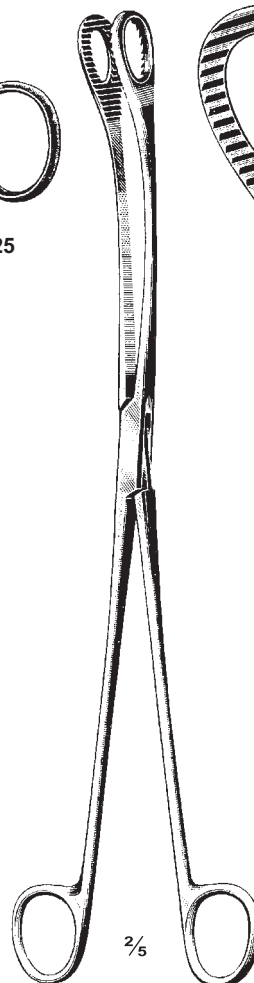

2/5

Kelly  
217-13-32  
32 cm / 12 1/2"



1/4

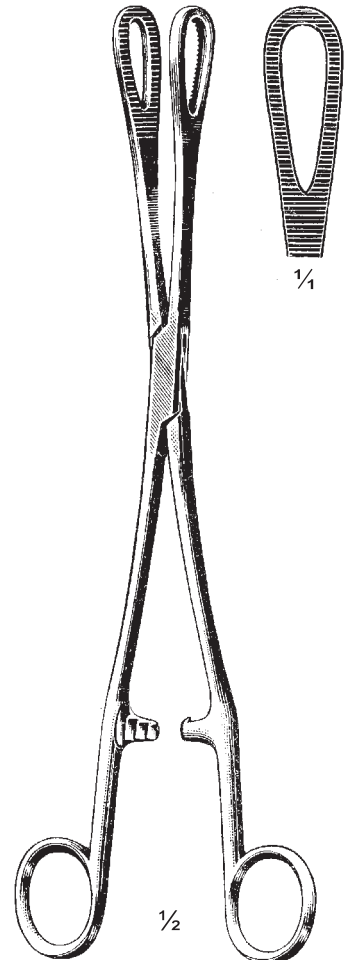

1/2

Ramley  
217-14-25  
25 cm / 10"

**Tupferzangen**  
**Dressing Forceps**  
**Pinces à tampons**

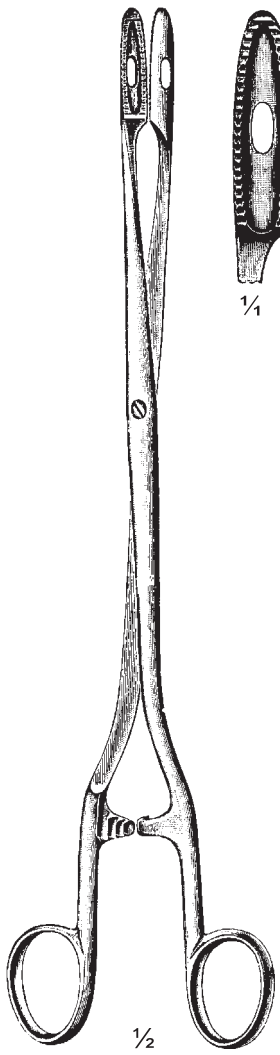

Sims-Maier  
 218-01-28  
 28 cm / 11"

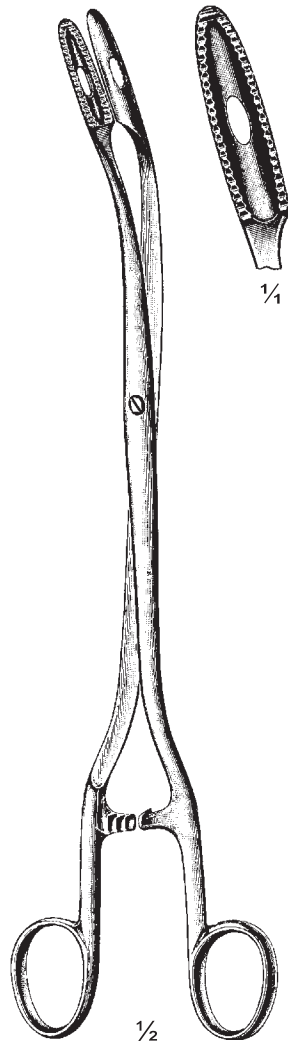

Sims-Maier  
 218-02-28  
 28 cm / 11"

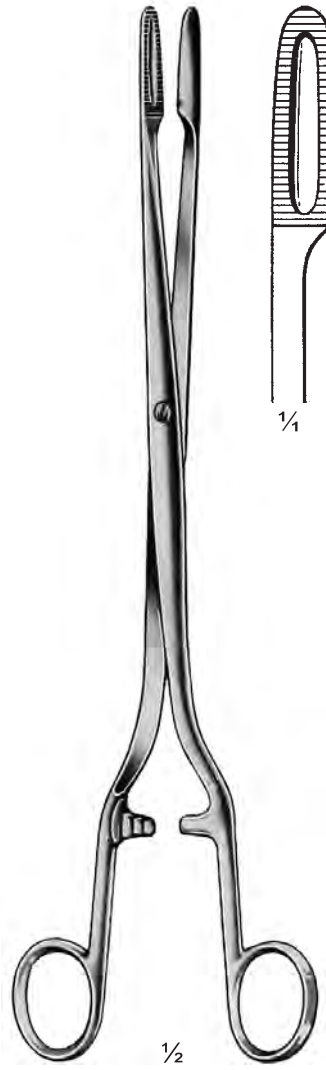

Sims-Maier  
 218-03-28  
 28 cm / 11"

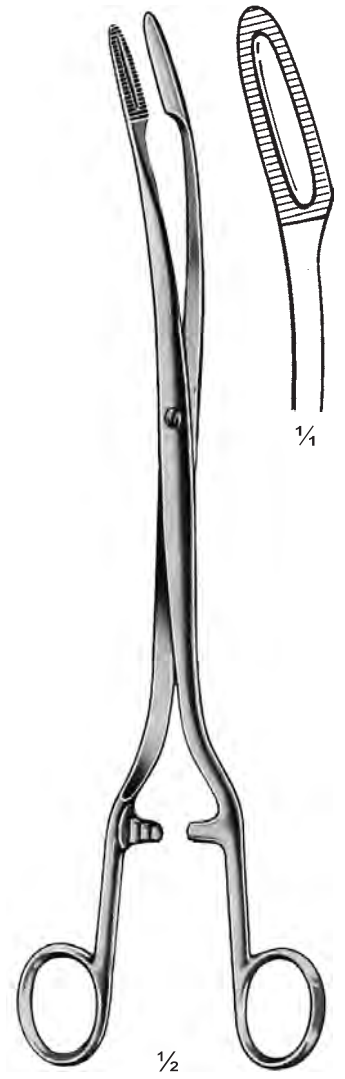

Sims-Maier  
 218-04-28  
 28 cm / 11"

**Tupferzangen**  
**Dressing Forceps**  
**Pinces à tampons**



1/2  
**219-01-26**



1/2  
**219-02-26**



1/2  
**219-03-26**



1/2  
**219-04-26**

Maier  
**219-01-26 & 219-02-26**  
 26 cm / 10 1/4"

Maier  
**219-03-26 & 219-04-26**  
 26 cm / 10 1/4"

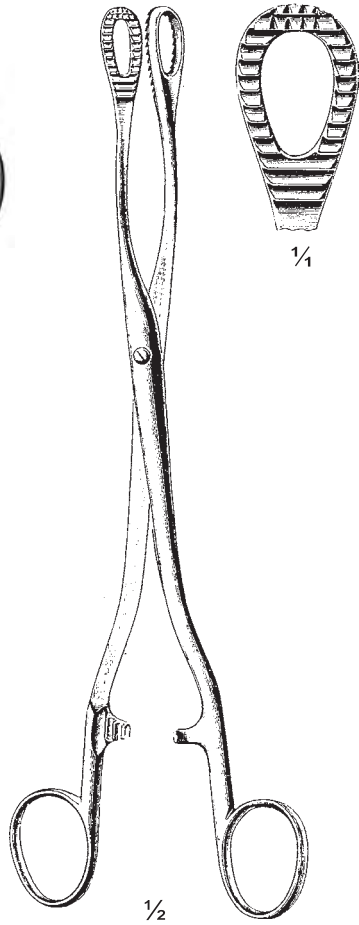

Heywood-Smith  
**219-05-25**  
 25 cm / 10"

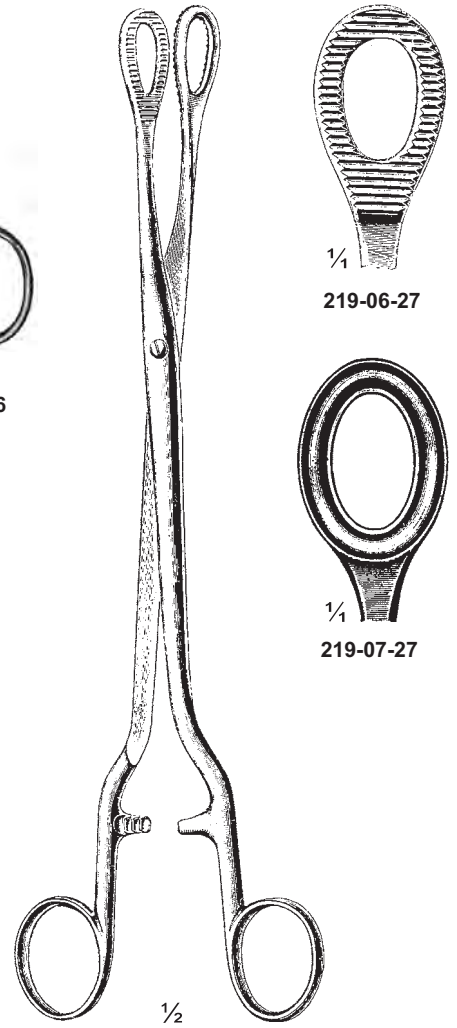

Noto  
**219-06-27 & 219-07-27**  
 27.5 cm / 10 3/4"

**Tupferzangen**  
**Dressing Forceps**  
**Pinces à tampons**



1/2

Pelkman  
 220-01-25 & 220-02-25  
 25 cm / 10"



1/4

220-01-25

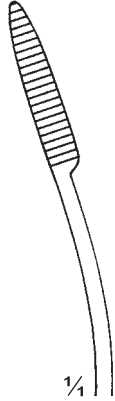

1/4

220-02-25

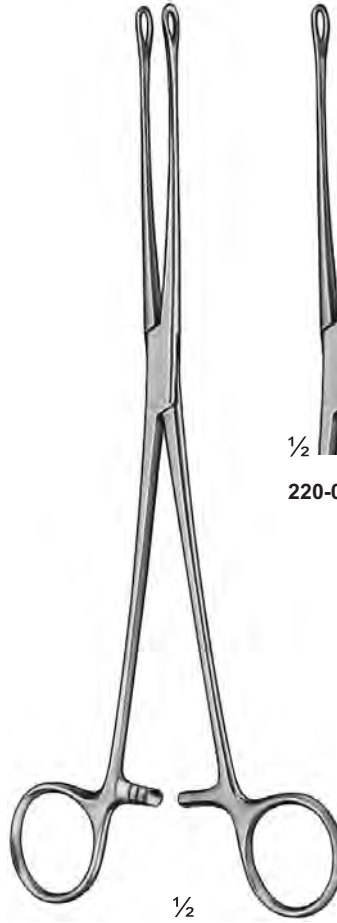

1/2

Bergmann-Foerster  
 220-03-24 & 220-04-24  
 24 cm / 9 1/2"

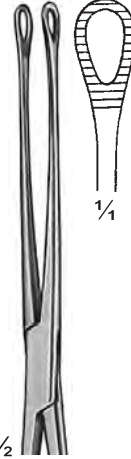

1/4

1/2

220-03-24

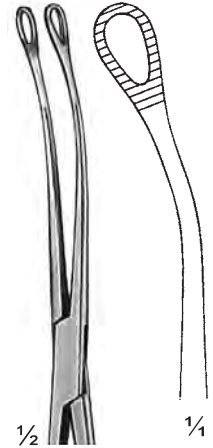

1/4

1/2

220-04-24

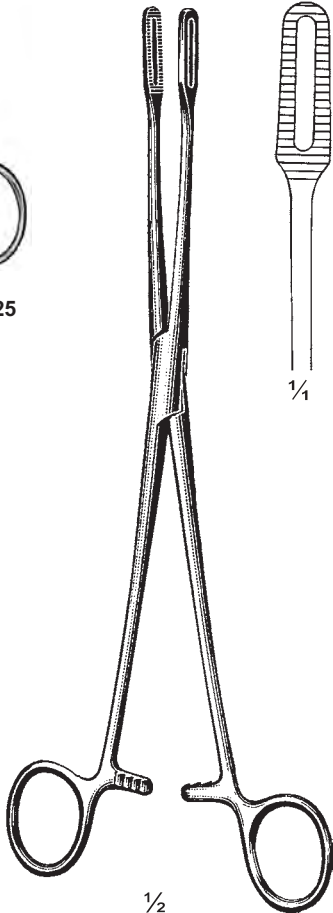

1/2

Fletcher (Javerts)  
 220-05-24  
 24 cm / 9 1/2"



1/4

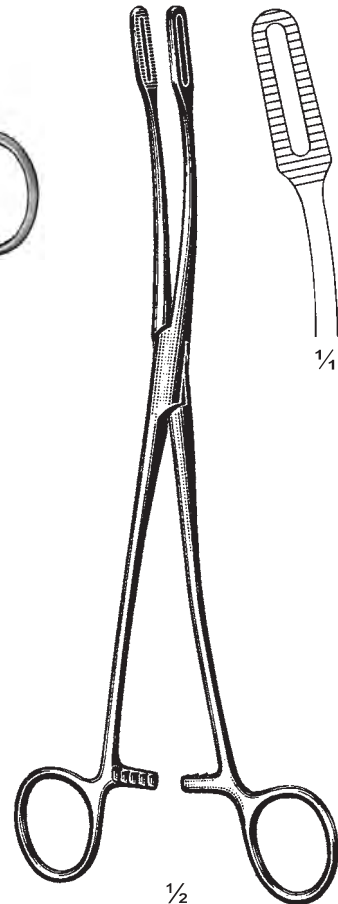

1/2

Fletcher (Javerts)  
 220-06-24  
 24 cm / 9 1/2"



1/4

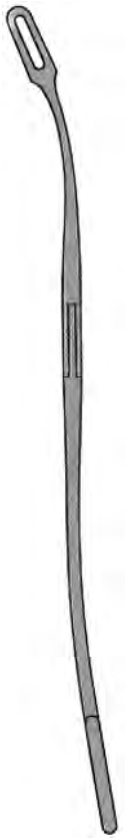



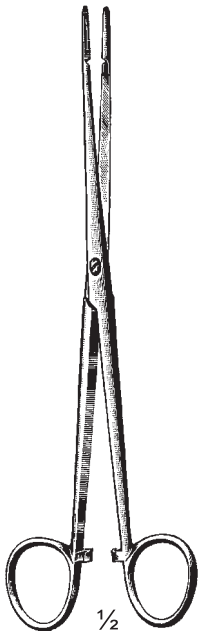

221-01-17 & 221-02-17  
 17 cm / 6¾"

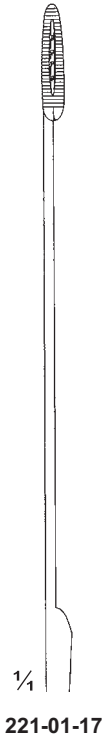

221-01-17

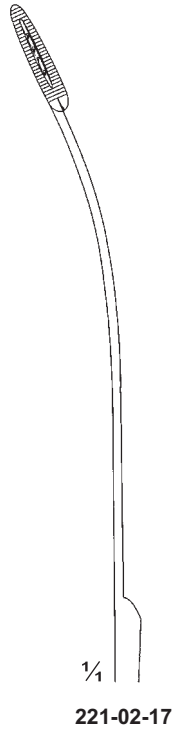

221-02-17

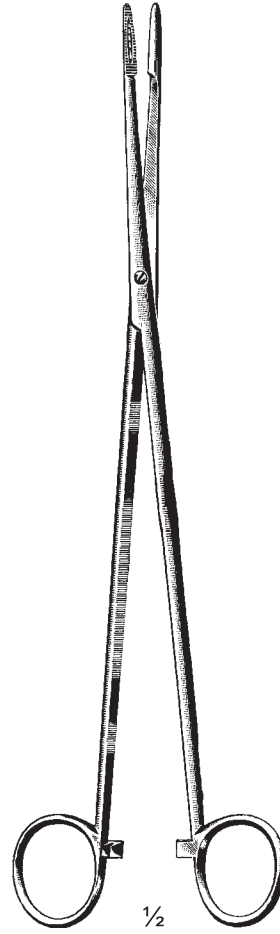

221-03-25 & 221-04-25  
 25 cm / 10"

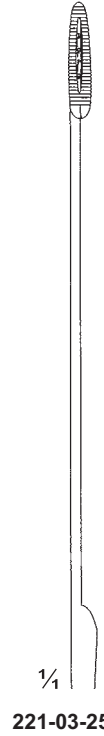

221-03-25

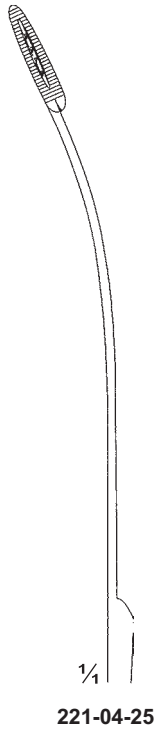

221-04-25

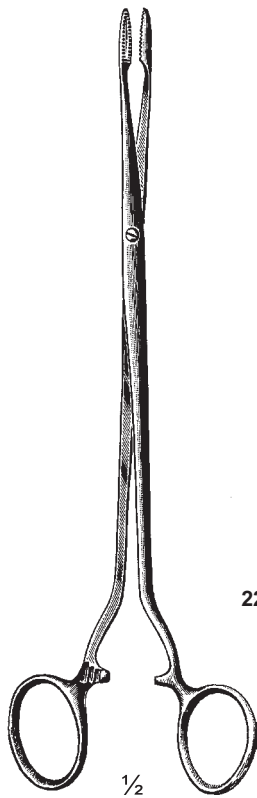

Duplay  
 221-05-20 & 221-06-20  
 20 cm / 8"

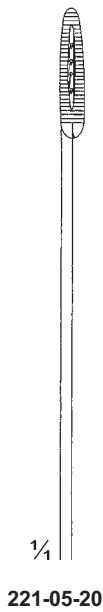

221-05-20

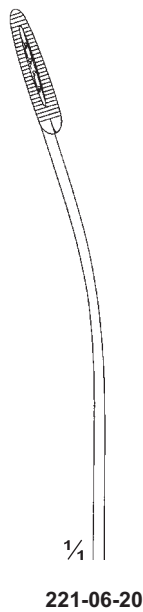

221-06-20

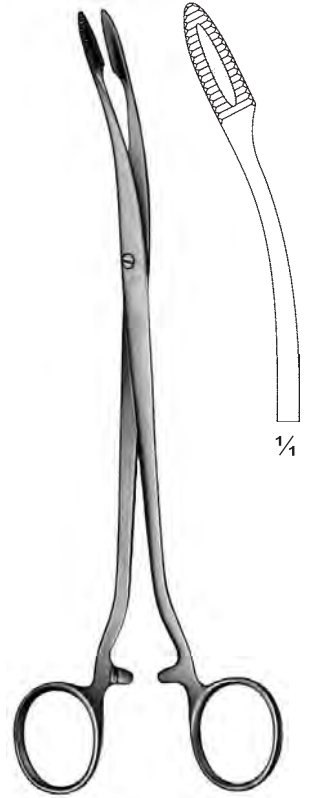

Duplay  
 221-07-19  
 19 cm / 7½"

1/4

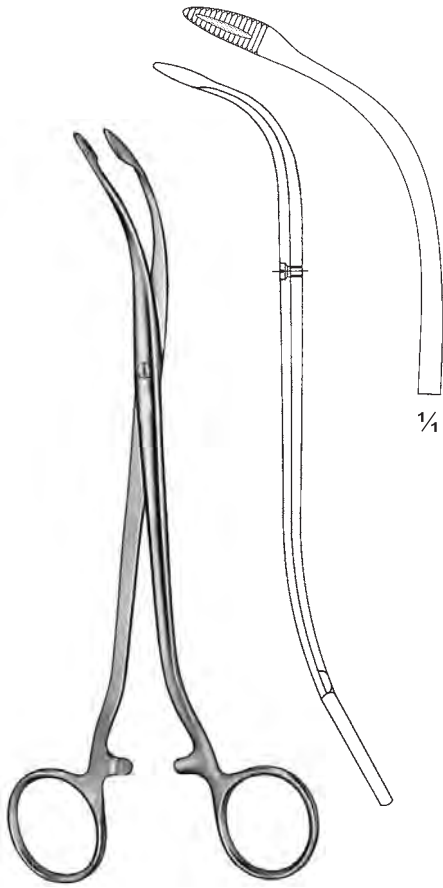

Pitha  
222-01-22  
22.5 cm / 8 3/4"

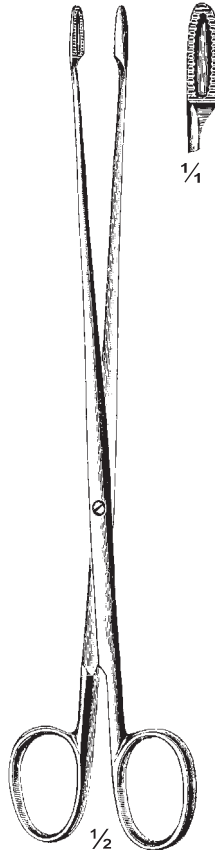

Pitha  
222-02-22  
22.5 cm / 8 3/4"

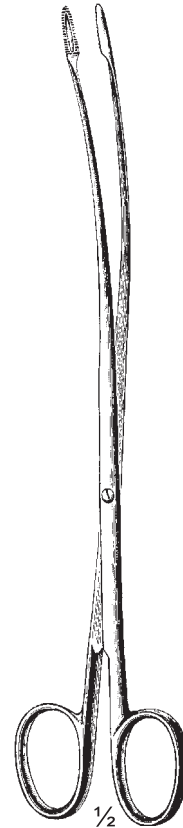

Pitha  
222-03-22  
22.5 cm / 8 3/4"



Gross  
222-04-14 14.5 cm / 5 3/4"  
222-05-16 16 cm / 6 1/4"  
222-06-18 18 cm / 7"  
222-07-20 20 cm / 8"

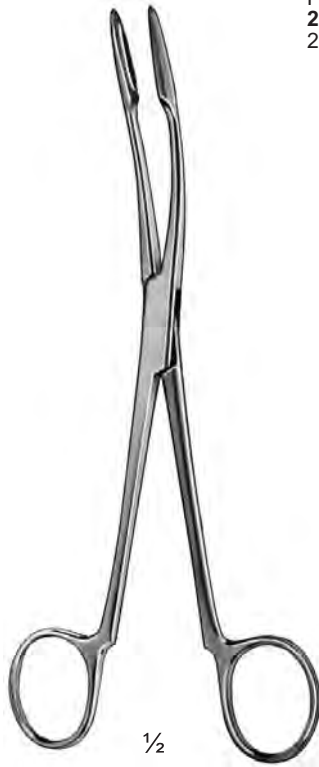

Gross  
222-08-14 14.5 cm / 5 3/4"  
222-09-16 16 cm / 6 1/4"  
222-10-18 18 cm / 7"  
222-11-20 20 cm / 8"

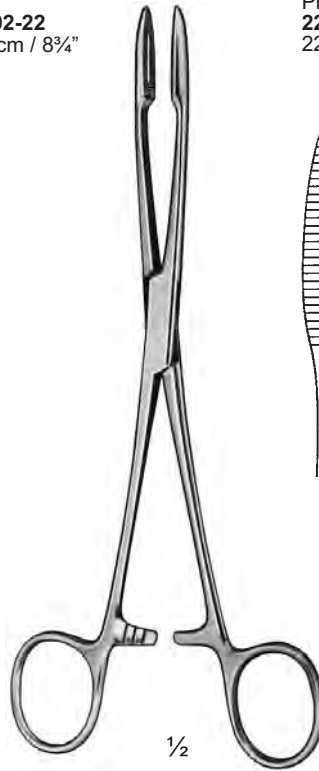

Gross  
222-12-14 14.5 cm / 5 3/4"  
222-13-16 16 cm / 6 1/4"  
222-14-18 18 cm / 7"  
222-15-20 20 cm / 8"



Gross  
222-16-14 14.5 cm / 5 3/4"  
222-17-16 16 cm / 6 1/4"  
222-18-18 18 cm / 7"  
222-19-20 20 cm / 8"

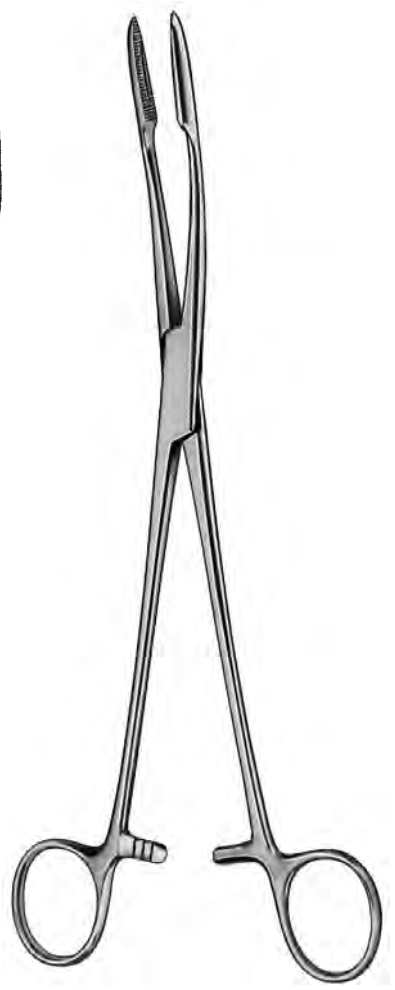
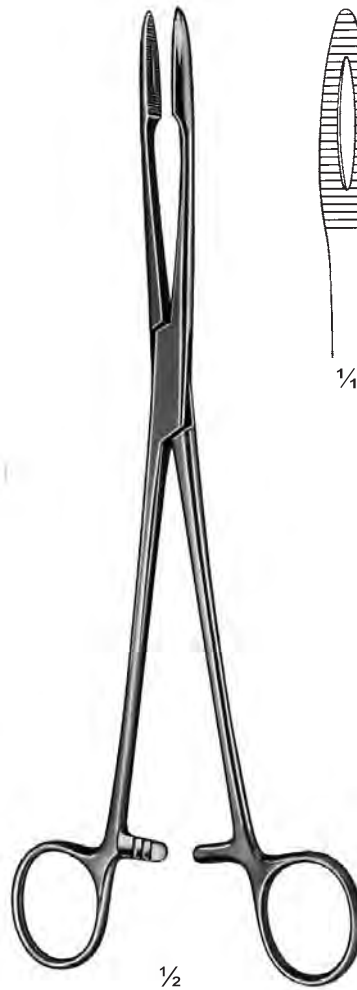
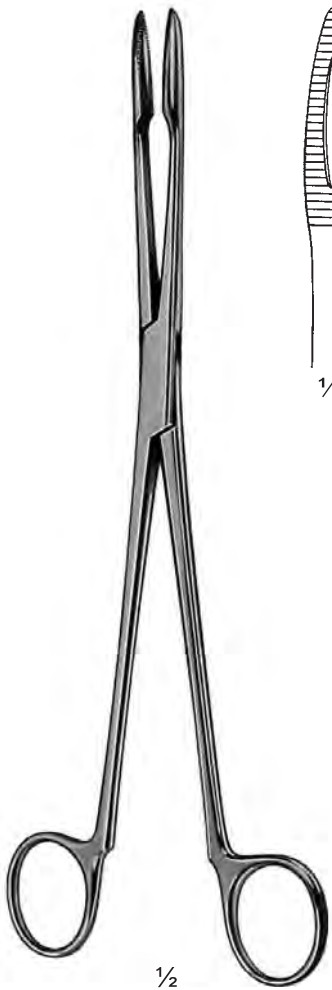

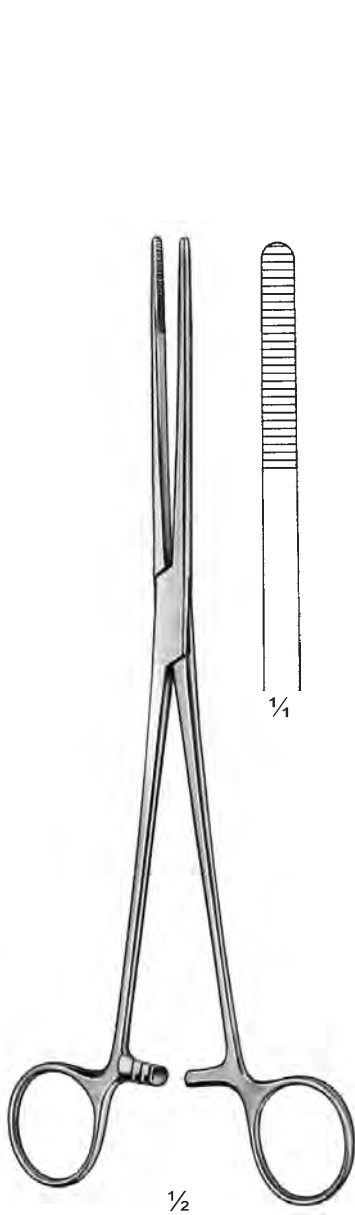

Bozemann  
 224-01-26  
 26 cm / 10 $\frac{1}{4}$ "

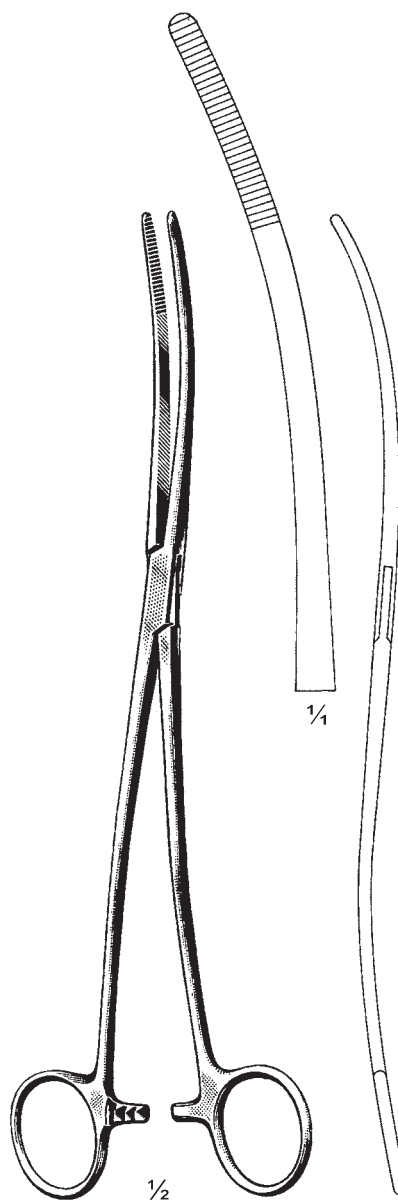

Bozemann  
 224-02-26  
 26 cm / 10 $\frac{1}{4}$ "

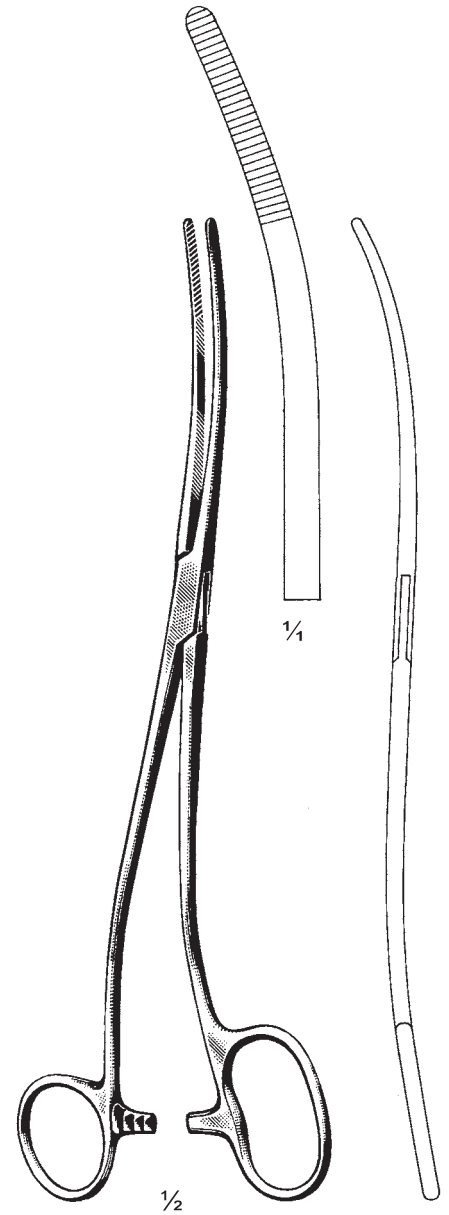

Bozemann-Douglas  
 224-03-26  
 26 cm / 10 $\frac{1}{4}$ "

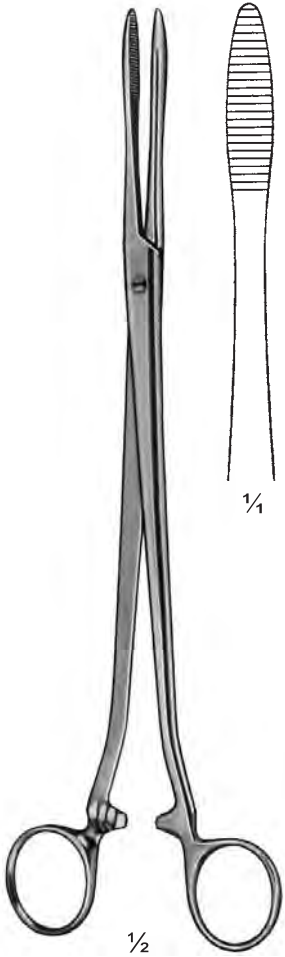

$\frac{1}{2}$   
 Collin  
 225-01-25  
 25 cm / 10"

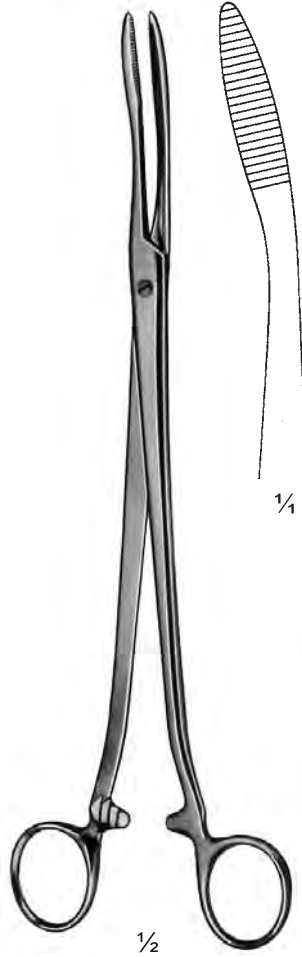

$\frac{1}{2}$   
 Collin  
 225-02-25  
 25 cm / 10"

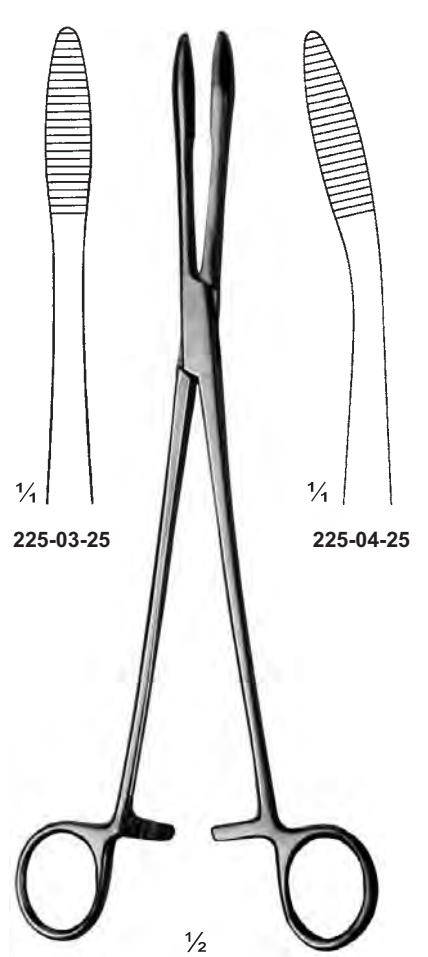

$\frac{1}{2}$   
 Collin  
 225-03-25 & 225-04-25  
 25 cm / 10"

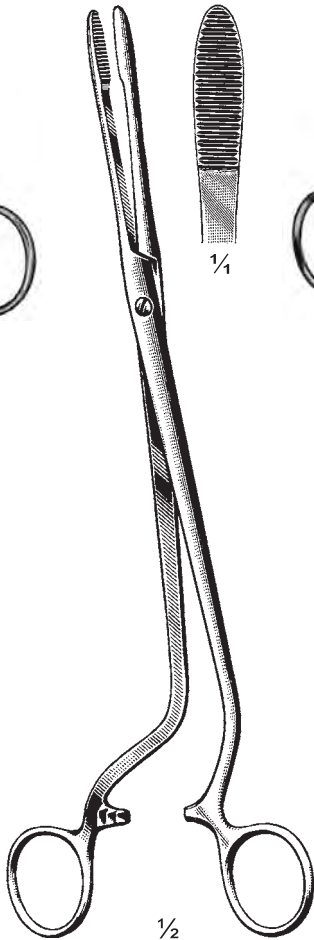

$\frac{1}{2}$   
 Cheron  
 225-05-25  
 25 cm / 10"

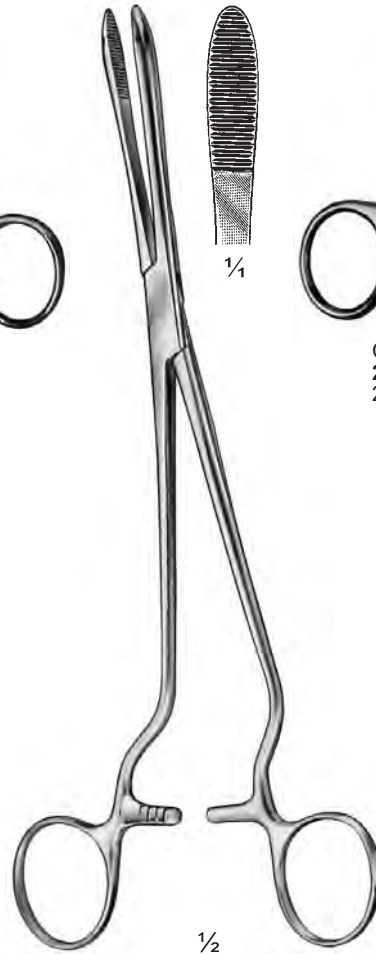

$\frac{1}{2}$   
 Cheron  
 225-06-25  
 25 cm / 10"

**Tupferzangen  
Dressing Forceps  
Pincès à tampons**

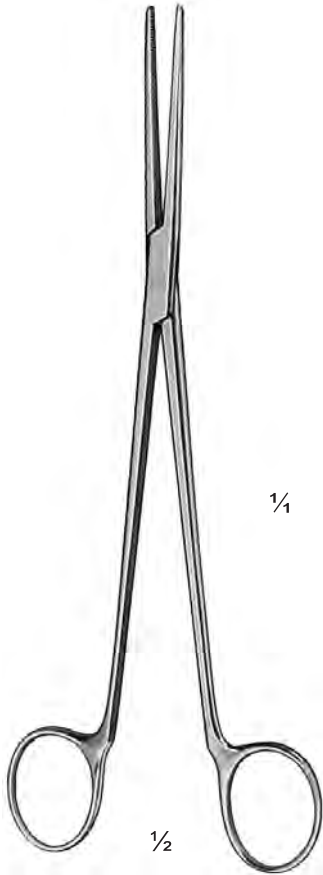

Westernmark  
226-01-23  
23 cm / 9"

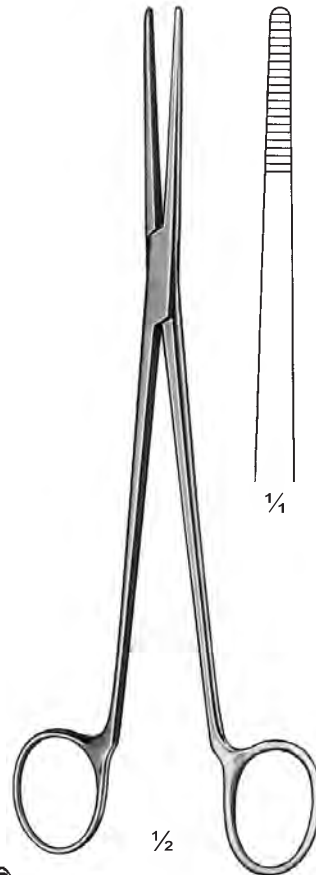

Westernmark  
226-02-23  
23 cm / 9"

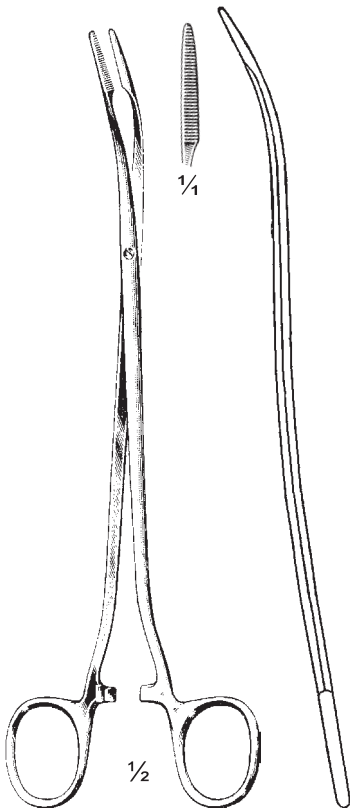

226-03-19  
19.5 cm / 7 3/4"

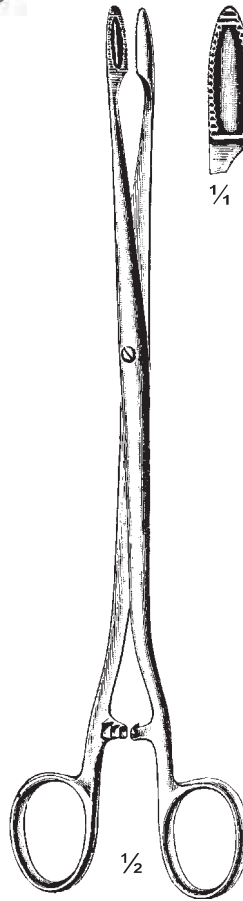

226-04-24  
24.5 cm / 9 3/4"

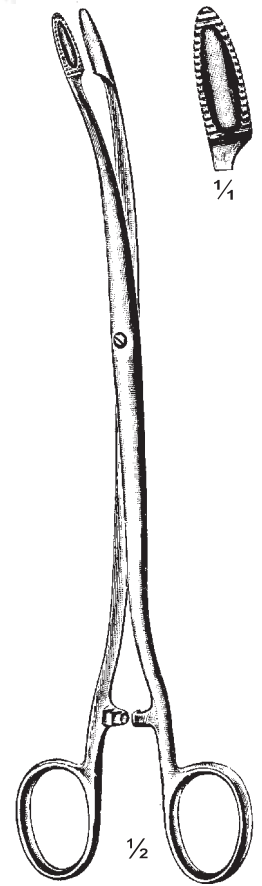

226-05-24  
24 cm / 9 1/2"



**Tupferzangen**  
**Dressing Forceps**  
**Pinces à tampons**



Ulrich  
 227-01-22 To 227-03-27

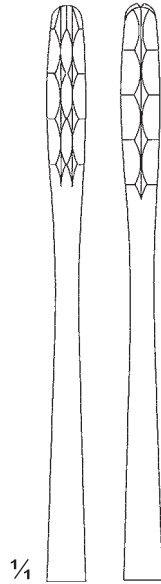

**227-01-22**  
 22 cm / 8<sup>3</sup>/<sub>4</sub>"



**227-02-25**  
 25 cm / 10"

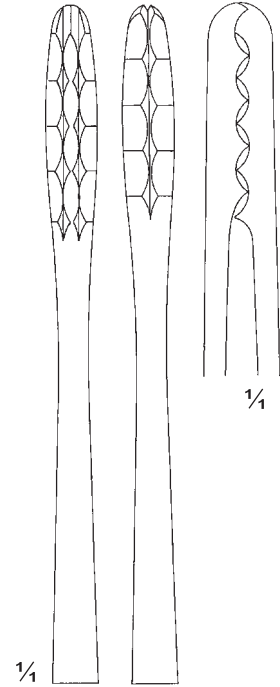

**227-03-27**  
 27 cm / 10<sup>3</sup>/<sub>4</sub>"



1/4



1/4



1/4



1/2

Ulrich  
**227-04-18**  
 18 cm / 7"



1/2

Ulrich  
**227-05-18**  
 18 cm / 7"

**Tupferzangen**  
**Dressing Forceps**  
**Pinces à tampons**



Ulrich  
 228-01-22 To 228-03-27



228-01-22  
 22 cm / 8 3/4"



228-02-25  
 25 cm / 10"



228-03-27  
 27 cm / 10 3/4"

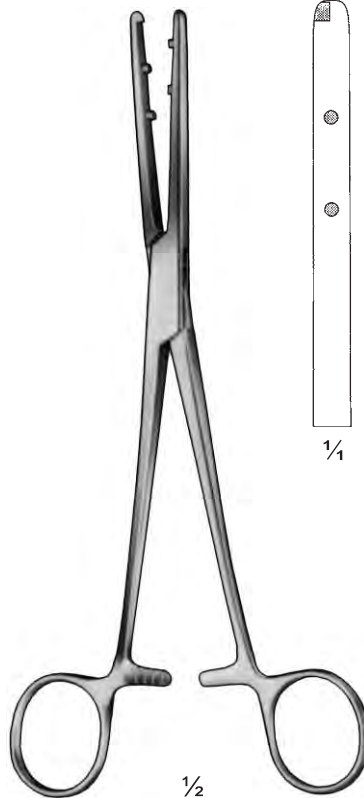

Emmet  
 228-04-21  
 21 cm / 8 1/4"



Sauerbruch  
 228-05-55  
 55 cm / 22"



Landau  
**229-01-16**  
16 cm / 6¼"  
Ø 2 mm



Landau  
**229-02-19**  
19 cm / 7½"  
Ø 2 mm

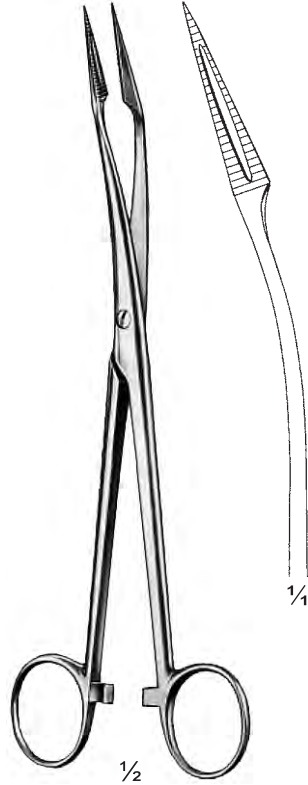

**229-03-20**  
20 cm / 8"  
Dilation Forceps

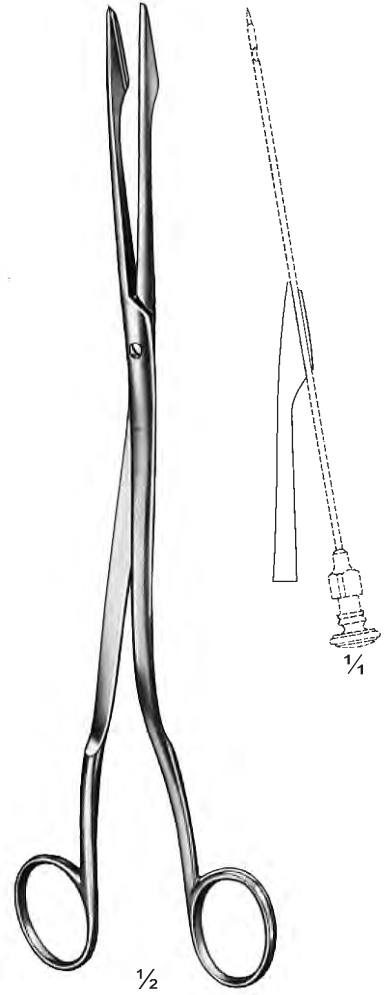

Vogal  
**229-04-26**  
26 cm / 10¼"  
Dilation Forceps

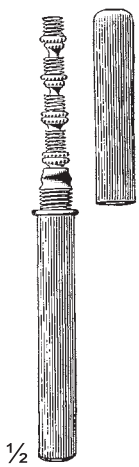

Universal  
**229-05-03** Set with 3 tips  
**229-06-04** Set with 4 tips  
12.5 cm / 5"

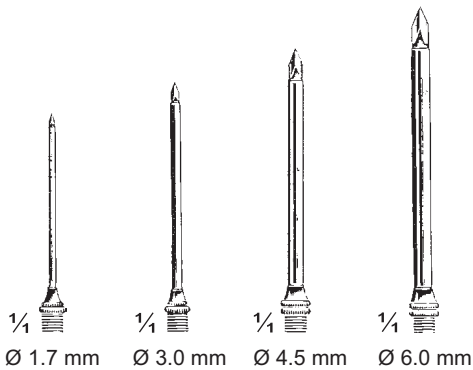

Universal  
**229-07-03** Set with 3 tips  
**229-08-04** Set with 4 tips  
12.5 cm / 5"

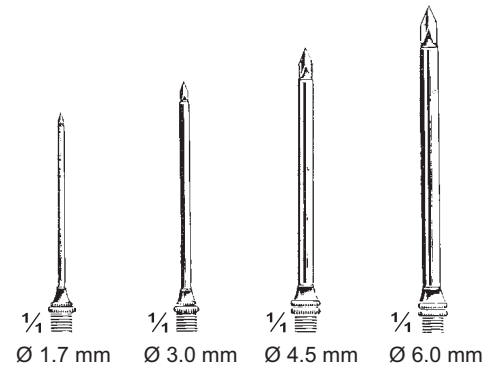



1/2

**Nelson-Standard**  
**230-01-03** Ø 3.0 mm  
**230-02-03** Ø 3.5 mm  
**230-03-04** Ø 4.0 mm  
**230-04-04** Ø 4.5 mm  
**230-05-05** Ø 5.0 mm  
**230-06-05** Ø 5.5 mm  
**230-07-06** Ø 6.0 mm  
 11 cm / 4 1/4"



1/2

**Roberts-Standard**  
**230-08-03** Ø 3.0 mm  
**230-09-03** Ø 3.5 mm  
**230-10-04** Ø 4.0 mm  
**230-11-04** Ø 4.5 mm  
**230-12-05** Ø 5.0 mm  
**230-13-05** Ø 5.5 mm  
**230-14-06** Ø 6.0 mm  
 12 cm / 4 3/4"



1/2

**Graefe-Standard**  
**230-15-03** Ø 3.0 mm  
**230-16-03** Ø 3.5 mm  
**230-17-04** Ø 4.0 mm  
**230-18-04** Ø 4.5 mm  
**230-19-05** Ø 5.0 mm  
**230-20-05** Ø 5.5 mm  
**230-21-06** Ø 6.0 mm  
 12 cm / 4 3/4"

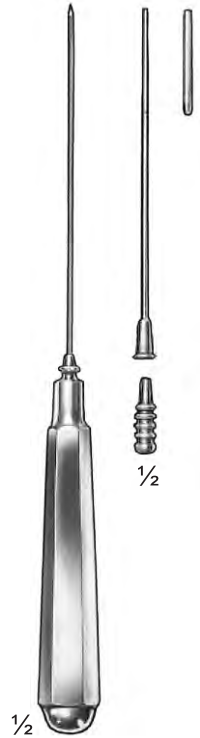

1/2

**Lichtwitz**  
**230-22-03**  
 19 cm / 7 1/2"  
 Ø 3.0 mm

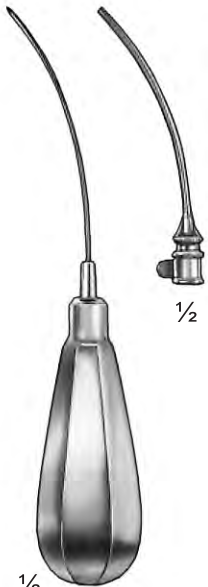

1/2

**Lichtwitz**  
**230-23-02**  
 15 cm / 6"  
 Ø 2.0 mm



1/2

**Pierce**  
**230-24-03** Ø 3.0 mm  
**230-25-04** Ø 4.0 mm  
**230-26-05** Ø 5.0 mm  
 17 cm / 6 3/4"

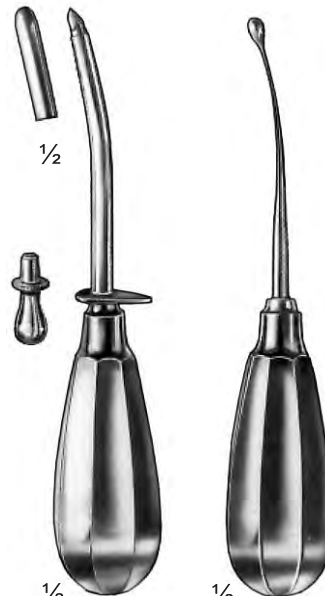

1/2

**Krause**  
**230-27-03** Ø 3.0 mm  
**230-28-04** Ø 4.0 mm  
**230-29-05** Ø 5.0 mm  
**230-30-05** Ø 5.5 mm  
 16 cm / 6 1/4"

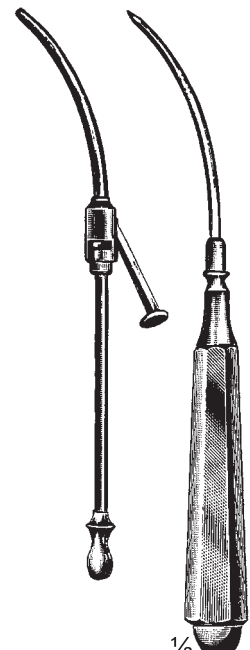

1/2

**Coakley**  
**230-31-02**  
 16 cm / 6 1/4"  
 Ø 2.25 mm

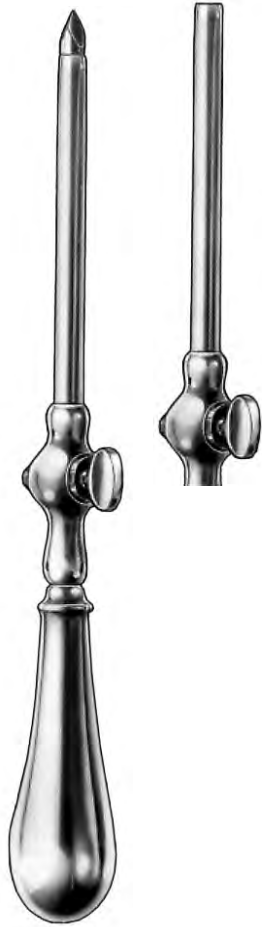
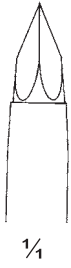

**Buelau**  
**231-01-08**  
21 cm / 8¼"  
Ø 8.0 mm

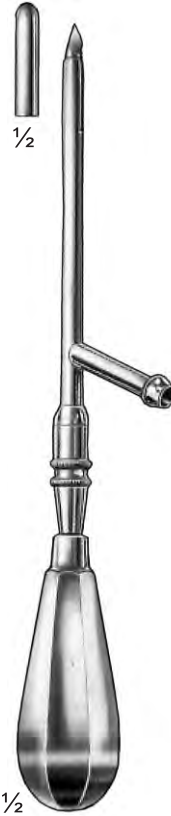

**Emmet**  
**231-02-06** Ø 6.0 mm  
**231-03-08** Ø 8.7 mm  
**231-04-10** Ø 10.0 mm  
21 cm / 8¼"



**Billroth**  
**231-05-05** Ø 5.0 mm  
**231-06-06** Ø 6.0 mm  
24 cm / 9½"

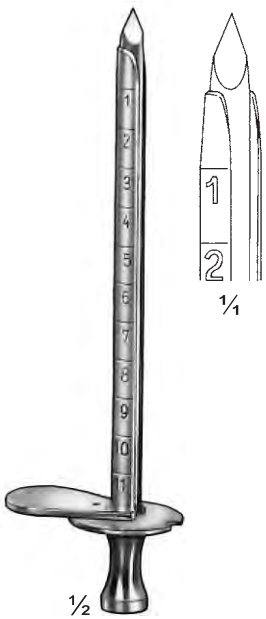

**Campbell**  
**231-07-16**  
16.5 cm / 6½"

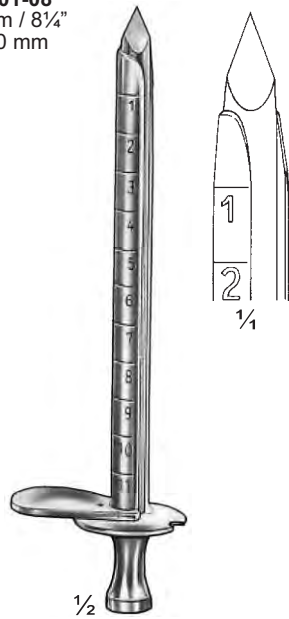

**Campbell**  
**231-08-16**  
16.5 cm / 6½"



**Hagedorn**  
**231-09-02** Ø 2.0 mm  
**231-10-02** Ø 2.5 mm  
10 cm / 4"  
**231-11-02** Ø 2.0 mm  
**231-12-02** Ø 2.5 mm  
13 cm / 5⅛"



**Douglas**  
**231-13-03**  
11.5 cm / 4½"  
Ø 3.0 mm

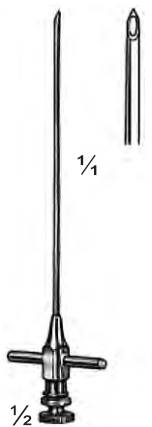

**Lichtwitz**  
**231-14-11**  
11 cm / 4¼"

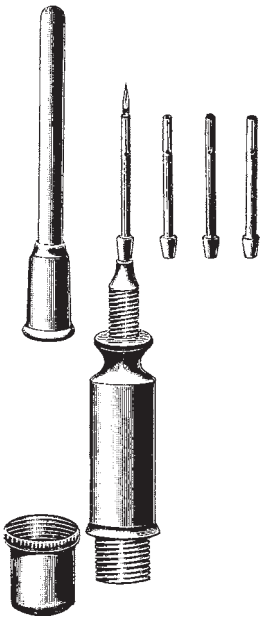

Southey  
**232-01-03**  
Set of 3 pcs

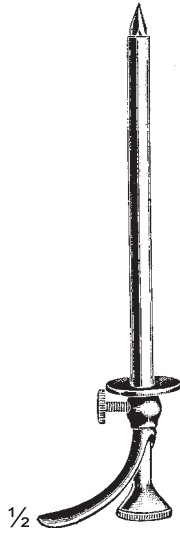

Lower  
**232-02-04** Ø 4.0 mm  
**232-03-05** Ø 5.5 mm  
**232-04-06** Ø 6.5 mm  
14 cm / 5½"

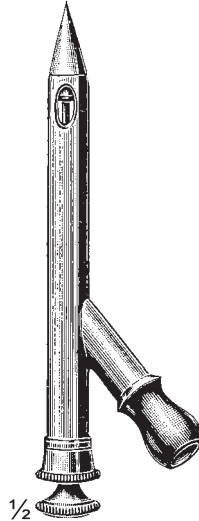

Pean  
**232-05-13**  
14 cm / 5½"  
Ø 13.5 mm

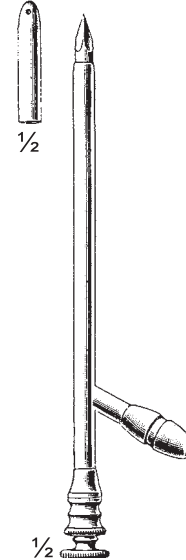

Ochsner  
**232-06-04** Ø 4.0 mm  
**232-07-05** Ø 5.5 mm  
**232-08-06** Ø 6.5 mm  
14 cm / 5½"

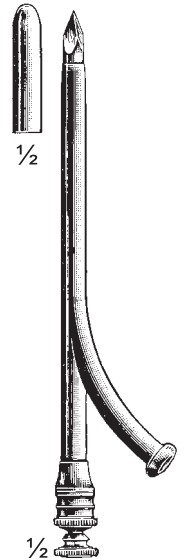

Ochsner  
**232-09-04** Ø 4.0 mm  
**232-10-05** Ø 5.5 mm  
**232-11-06** Ø 6.5 mm  
14 cm / 5½"



Curshmann  
**232-12-02** Ø 2.25 mm  
**232-13-02** Ø 2.50 mm  
**232-14-02** Ø 2.75 mm  
7 cm / 2¾"

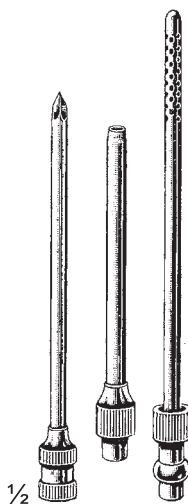

Duke  
**232-15-05**  
11.5 cm / 4½"  
Ø 5.5 mm



Brich  
**232-16-04**  
18 cm / 7"  
Ø 4.5 mm



Nelson  
**232-17-08 To 232-20-14**  
21 cm / 8¼"



**232-17-08**  
Ø 8 mm



**232-18-10**  
Ø 10 mm



**232-19-12**  
Ø 12 mm



**232-20-14**  
Ø 14 mm



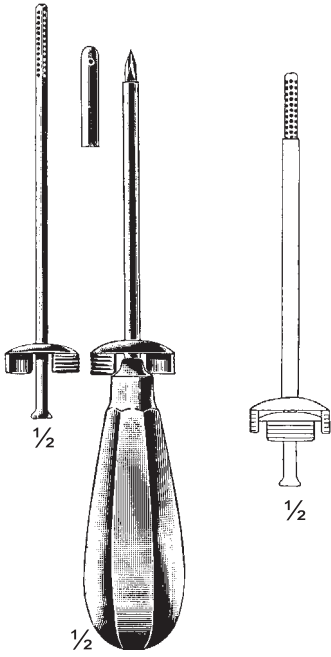

**233-01-13** 1.2 X 80 mm  
13 cm / 5 1/8"  
**233-02-16** 1.5 X 80 mm  
16 cm / 6 1/4"

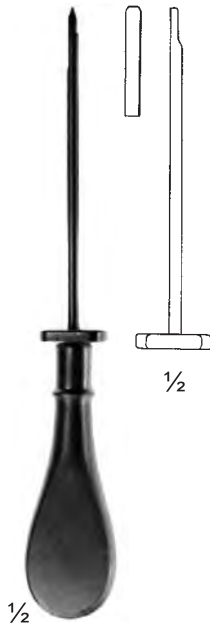

**233-03-03**  
16 cm / 6 1/4"  
Ø 3.5 mm

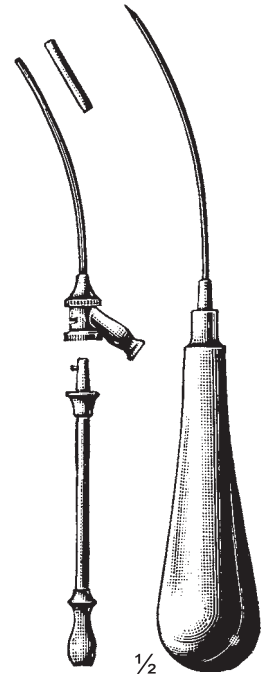

Haeggstroem  
**233-04-02** Ø 2.0 mm  
**233-05-03** Ø 3.5 mm  
18 cm / 7"



Fleurant  
**233-06-05**  
23 cm / 9"  
Ø 5.0 mm



Fleurant  
**233-07-05**  
23 cm / 9"  
Ø 5.0 mm

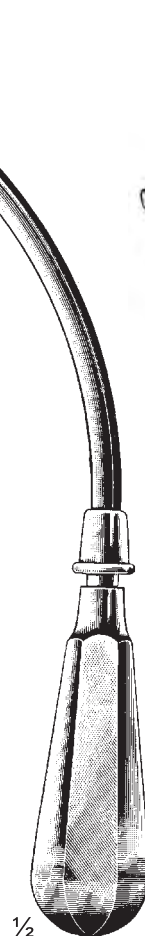

Douglas  
**233-08-10**  
27 cm / 10 1/2"  
Ø 10 mm



Fleurant  
**233-09-05**  
23 cm / 9"  
Ø 5.0 mm

# Sauger, Saugrohre Suction Tubes Tubes d'aspiration



**234-01-06**  
Ø 6 mm



**234-02-08**  
Ø 8 mm

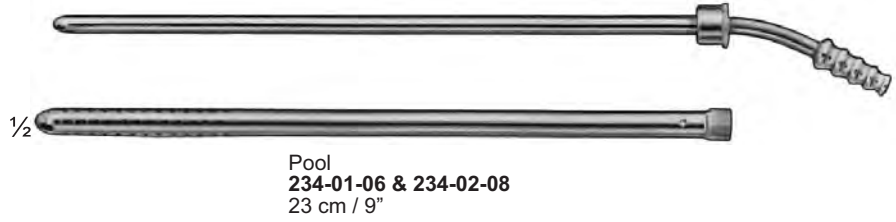

**234-03-06**  
Ø 6 mm



**234-04-10**  
Ø 10 mm

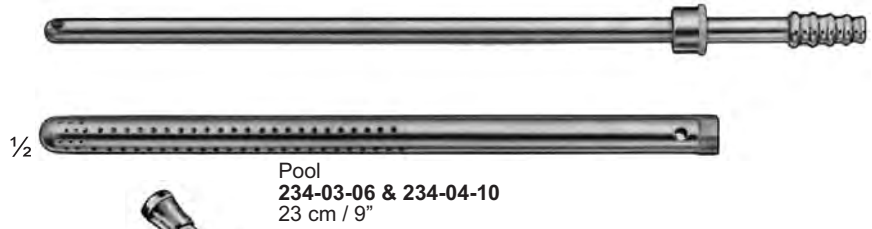

Ø 10 mm

Ø 10 mm

Ø 9 mm



**Yankauer**  
**234-05-28**  
28.5 cm / 11 1/4"  
Olive Ø 7-9 mm



**Yankauer**  
**234-06-28**  
28.5 cm / 11 1/4"  
Olive Ø 7-9 mm



**Yankauer**  
**234-07-29**  
29 cm / 11 1/2"



**Andrews-Pyncheon**  
**234-08-24**  
24 cm / 9 1/2"



**De Bakey**  
**234-09-27**  
27 cm / 10 3/4"  
Olive Ø 6-10 mm



1/2  
Adson  
235-01-04  
19 cm / 7 1/2"  
Ø 4 mm



1/2  
Adson  
235-02-04  
21 cm / 8 1/4"  
Ø 4 mm



1/2  
Frazier (Fergusson)  
235-03-02 Ø 2.0 mm  
235-04-02 Ø 2.5 mm  
235-05-03 Ø 3.0 mm  
235-06-04 Ø 4.0 mm  
18 cm / 7"



1/2  
Poppen  
235-07-02 Ø 2.0 mm  
235-08-02 Ø 2.5 mm  
235-09-03 Ø 3.0 mm  
235-10-04 Ø 4.0 mm  
13 cm / 5 1/4"



1/2  
Poppen  
235-11-02 Ø 2.5 mm  
235-12-03 Ø 3.0 mm  
13 cm / 5 1/4"



1/2  
De Bakley  
235-14-16  
16 cm / 6 1/4"  
Olive Ø 9 mm

1/2  
De Bakley  
235-13-27  
27 cm / 10 3/4"  
Olive Ø 9 mm



1/2  
Seiffert  
235-15-12  
12.5 cm / 5"

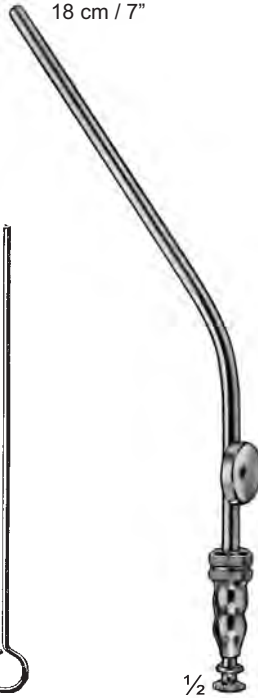

1/2  
Frazier  
235-16-03 Ø 3.0 mm  
235-17-05 Ø 5.0 mm  
18 cm / 7"  
Olive Ø 6-9 mm



1/2  
Fergusson  
235-18-02 Ø 2.0 mm  
235-18-025 Ø 2.5 mm  
235-19-03 Ø 3.0 mm  
235-20-04 Ø 4.0 mm  
235-21-05 Ø 5.0 mm  
18 cm / 7"  
Olive Ø 6-9 mm

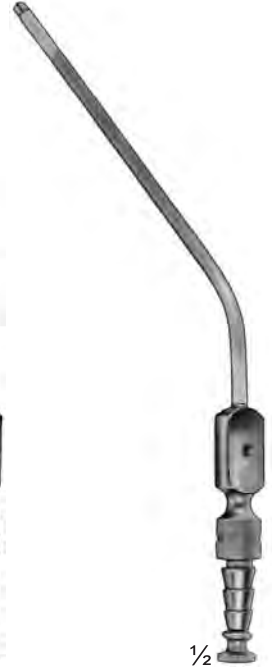

1/2  
Fergusson  
235-22-04 Ø 4.0 mm  
18 cm / 7"  
Olive Ø 6-9 mm

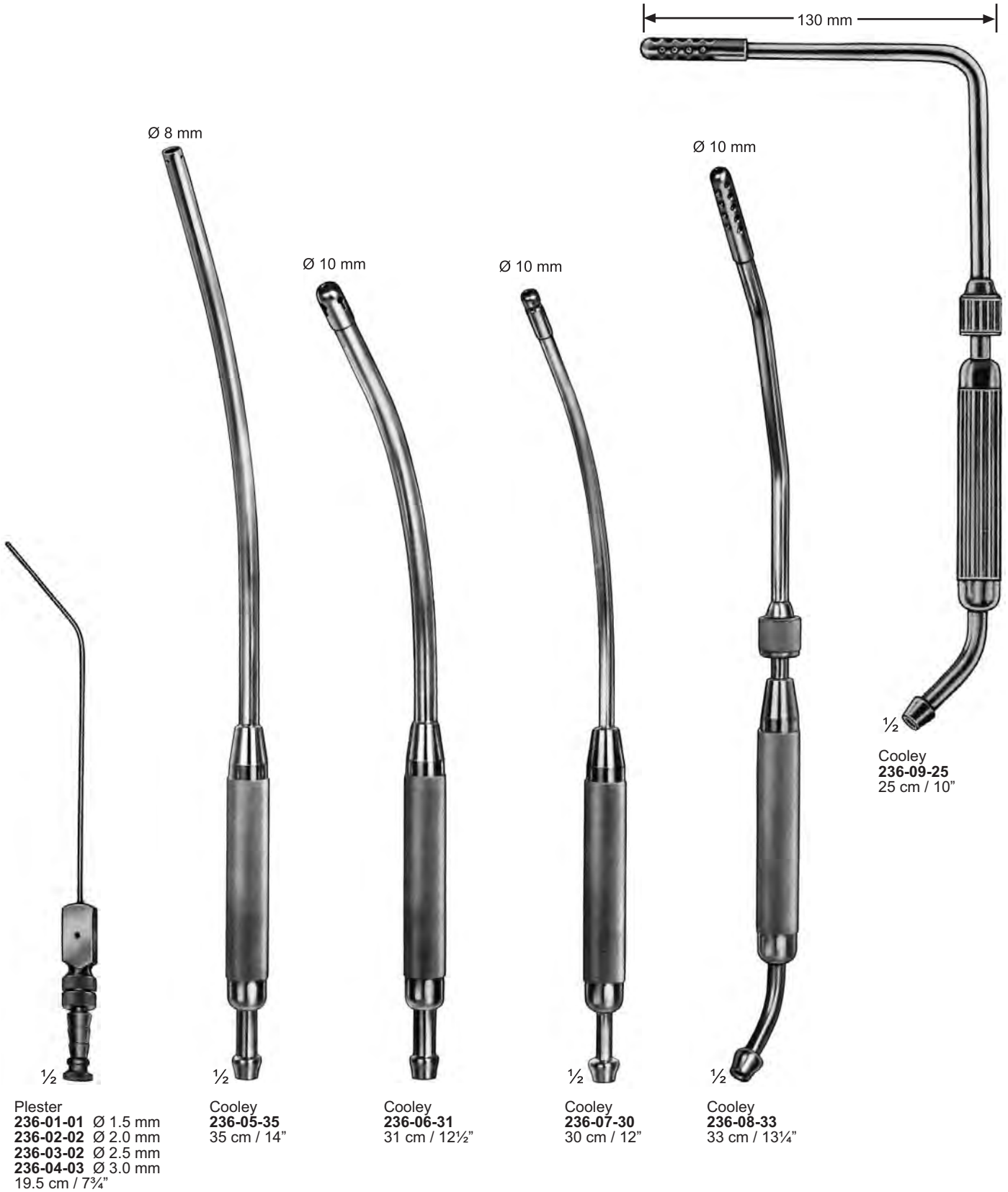



Wullstein  
237-01-04 To 237-03-08  
14 cm / 5½"  
237-04-00  
Micro suction tube with lower hub and  
3 suction cannulas 237-01-04 To 237-03-08

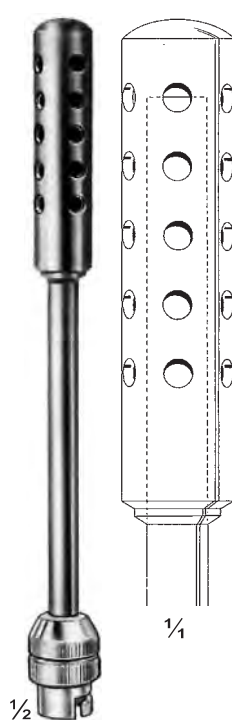
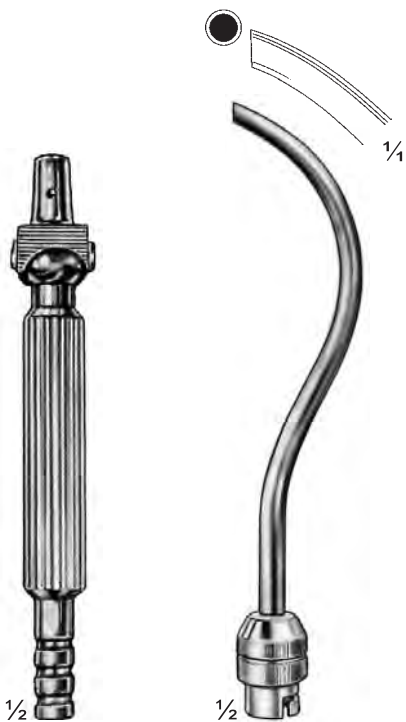
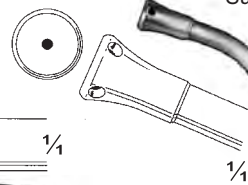
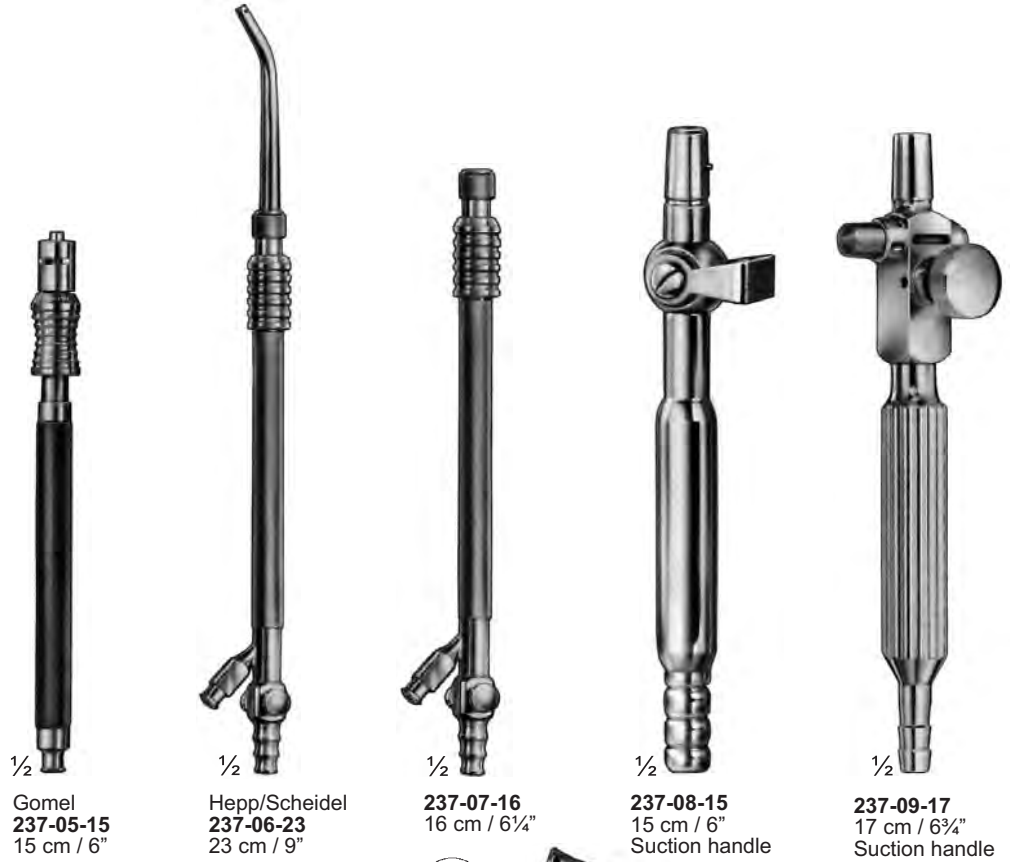



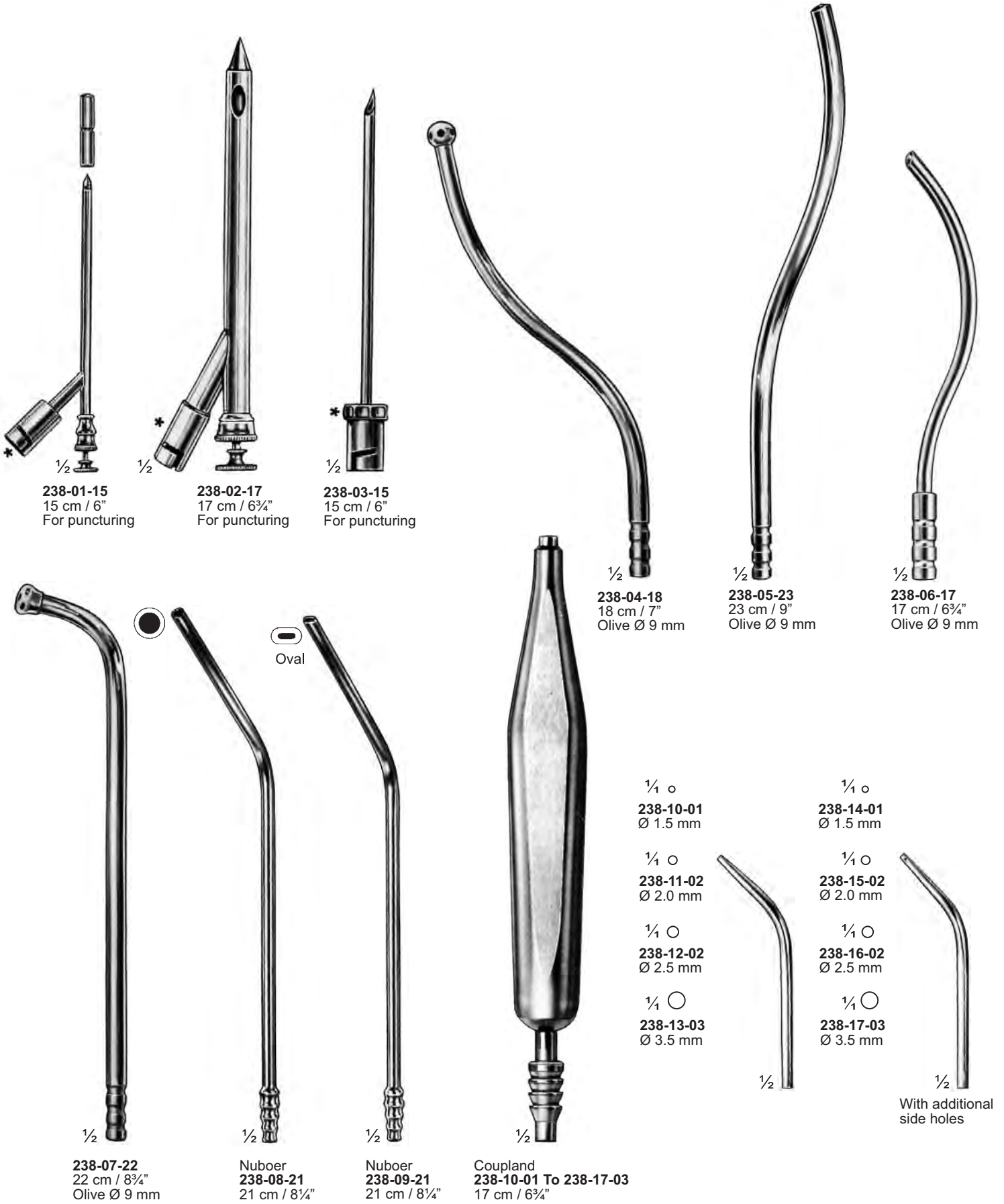



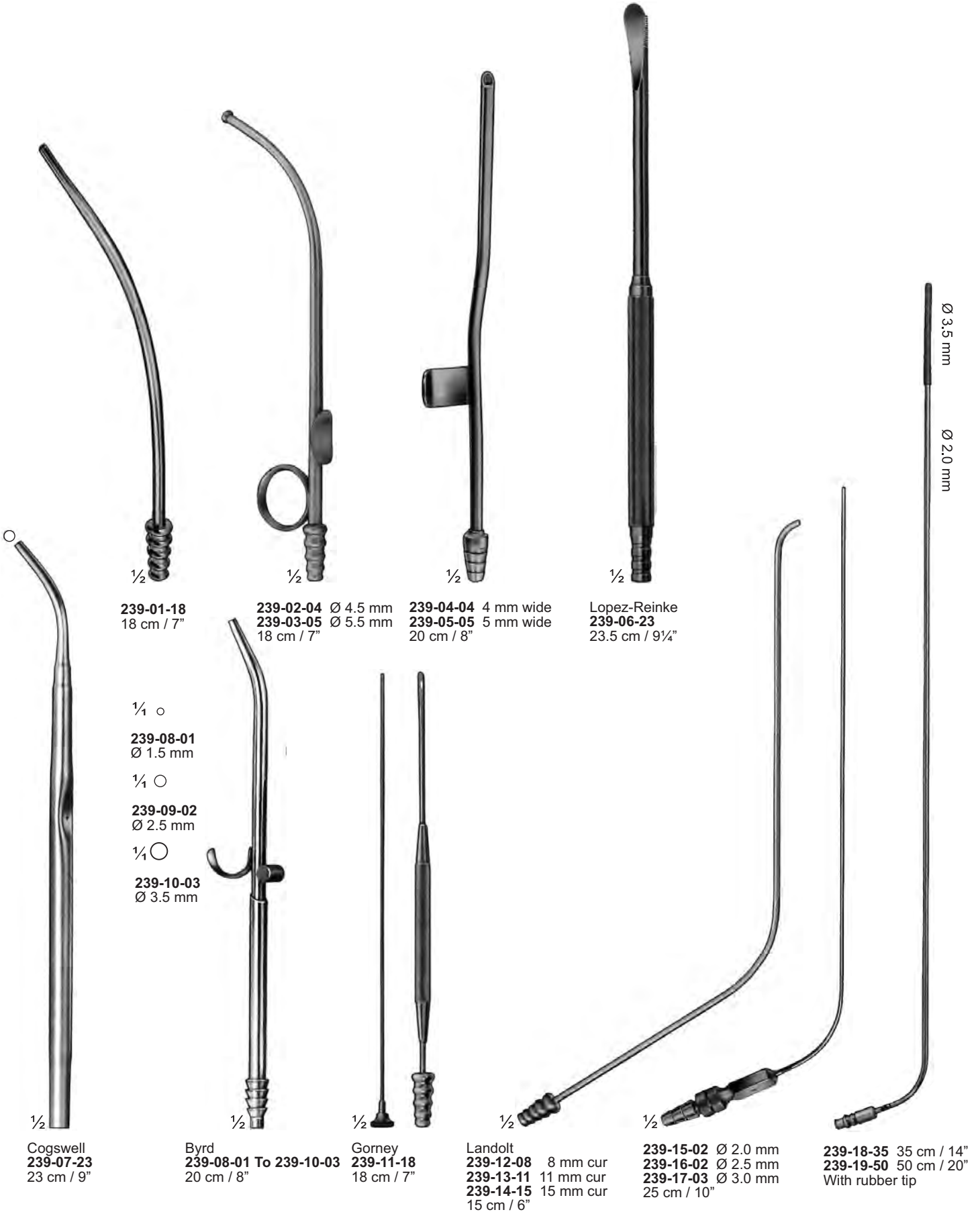

# Sauger, Saugrohre Suction Tubes Tubes d'aspiration

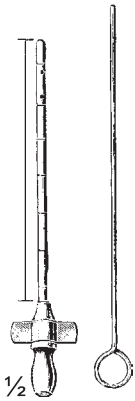

240-01-02 Ø 2.0 mm  
240-02-02 Ø 2.5 mm  
10 cm / 4"  
Silver plated



Seiffert  
240-03-12  
12.5 cm / 5"



240-04-02 Ø 2.0 mm  
240-05-02 Ø 2.5 mm  
17 cm / 6¾"



240-06-22  
150 mm X 1.5 mm



240-07-22  
150 mm X 2.0 mm



240-08-22  
150 mm X 2.5 mm



240-09-22  
150 mm X 3.5 mm

Yasargil  
240-06-22 To 240-09-22  
22 cm / 8¾"  
Olive Ø 6.5-9 mm

Usable length 150 mm

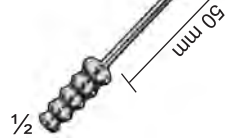

Klima-Rosegger  
240-10-09  
9 cm / 3"  
1.80 X 35 mm



¼



¼



¼



¼

Strauss  
240-11-06 1.00 X 40 mm  
240-12-06 1.20 X 40 mm  
240-13-06 1.40 X 40 mm  
6.5 cm / 2½"



¼

Dattner  
240-14-11  
11 cm / 4¼"  
0.9 X 65 mm



¼

240-15-16 1.40 mm  
240-16-16 1.80 mm  
16.5 cm / 6½"

# Nadelhalter Needle Holders Porte-aiguilles

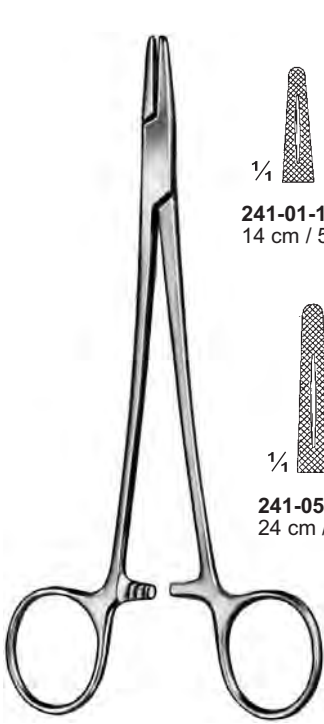

Mayo-Hegar  
241-01-14 To 241-07-30

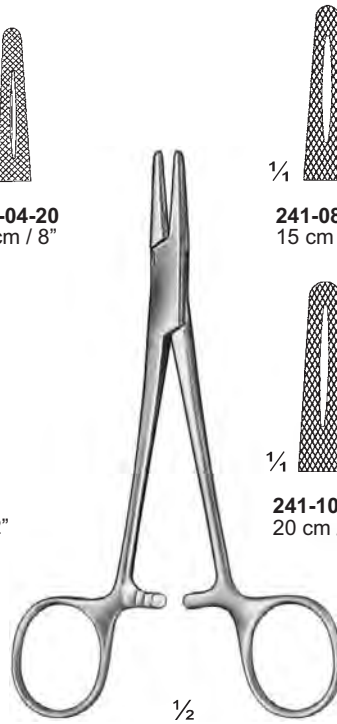
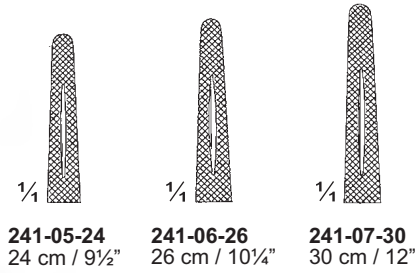
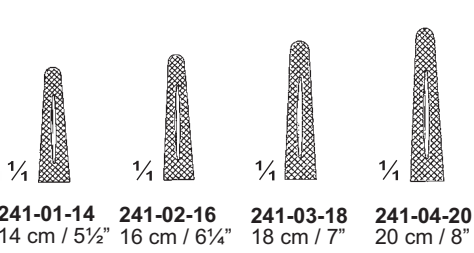

Hegar  
241-08-15 To 241-11-20  
Heavy pattern

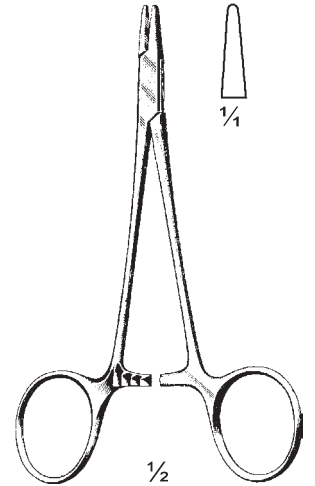
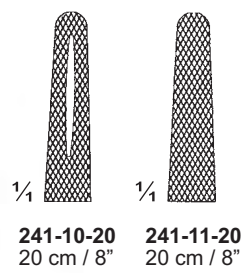
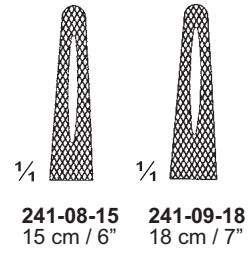

Webster  
241-12-12  
12.5 cm / 5"

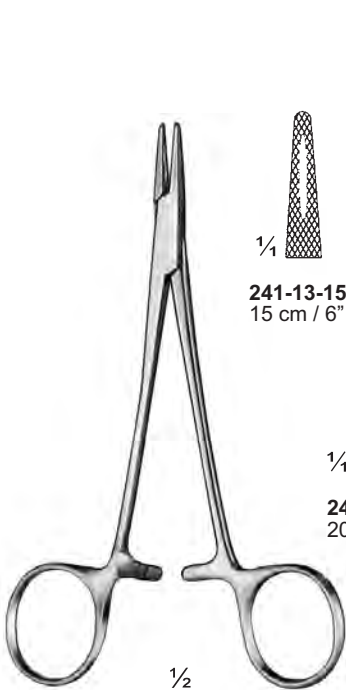

Mayo-Hegar  
241-13-15 To 241-15-20  
Medium fine pattern

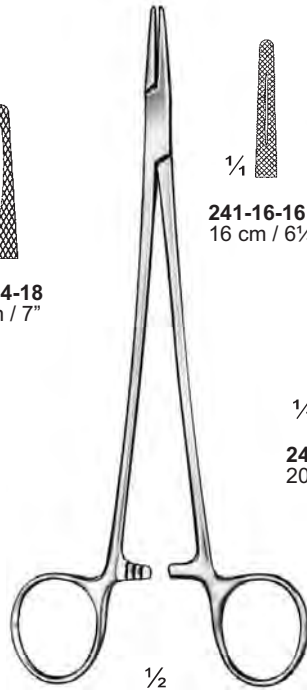
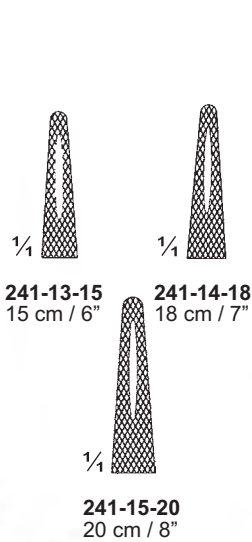

Mayo-Hegar  
241-16-16 To 241-18-20  
Delicate pattern

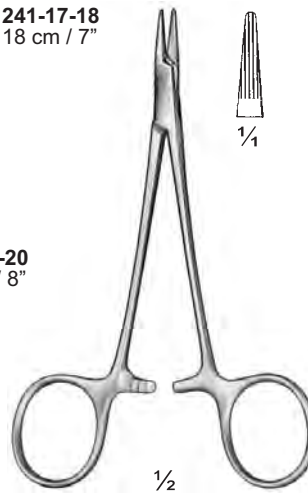
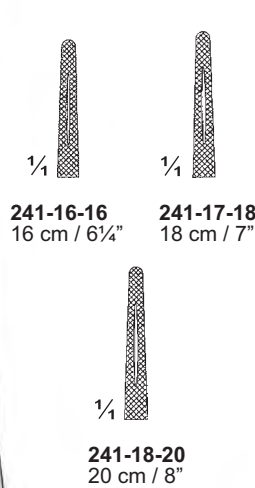

Converse  
241-19-12  
12.5 cm / 5"

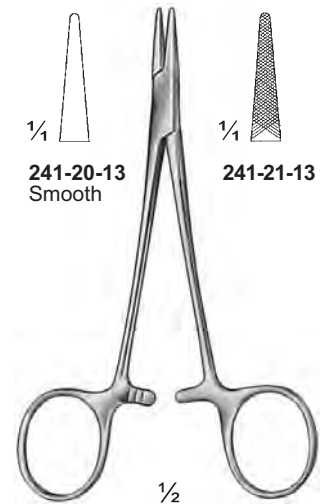

Halsey  
241-20-13 & 241-21-13  
13 cm / 5 1/8"

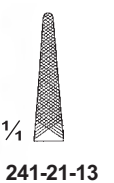
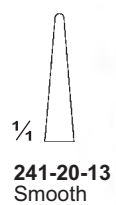

# Nadelhalter Needle Holders Porte-aiguilles

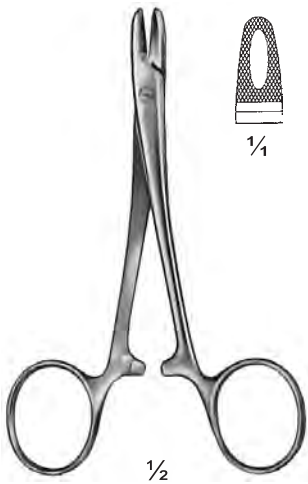

Doyen  
242-01-12  
12.5 cm / 5"

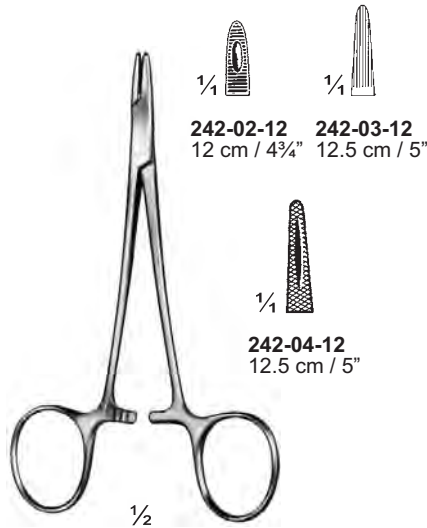

Derf  
242-02 To 242-04

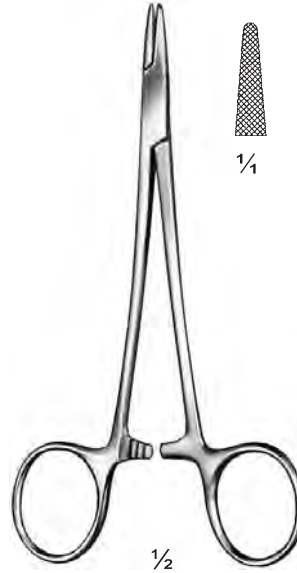

Hegar-Baumgartner  
242-05-14  
14 cm / 5 1/2"

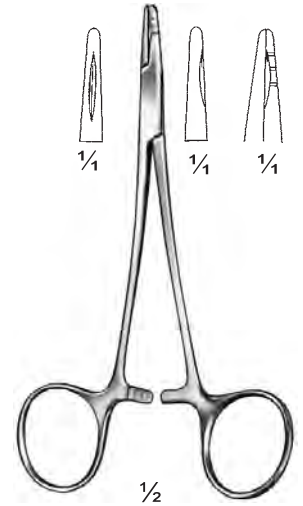

Neivert  
242-06-13  
13 cm / 5 1/8"

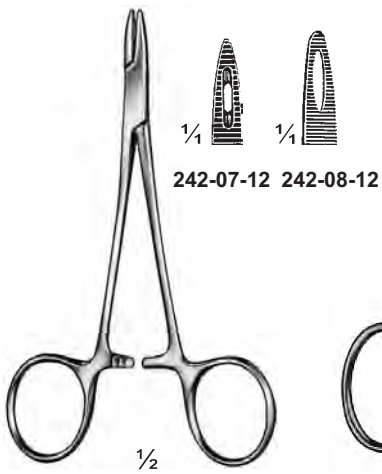

Collier  
242-07-12 & 242-08-12  
12.5 cm / 5"

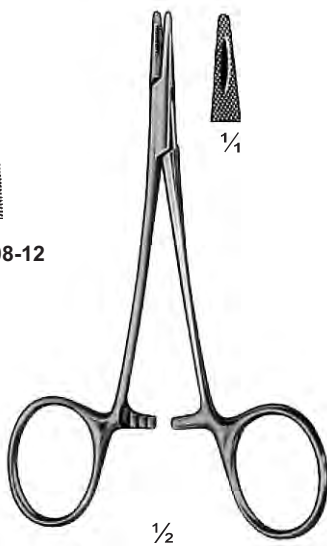

Rehbein-Baby  
242-09-11 11.5 cm / 4 1/2"  
242-10-14 14 cm / 5 1/2"

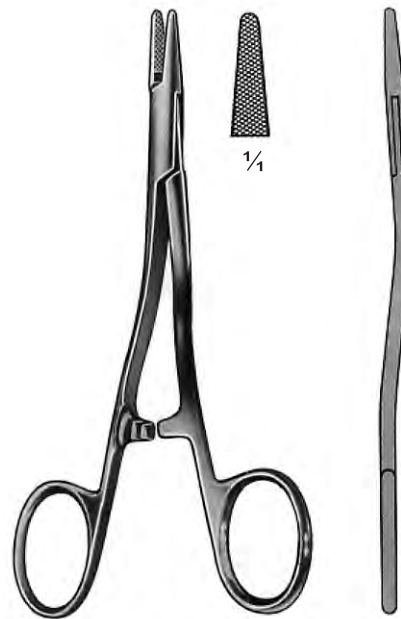

Kilner  
242-11-13 13 cm / 5 1/8"  
242-12-15 15 cm / 6"  
242-13-18 18 cm / 7"

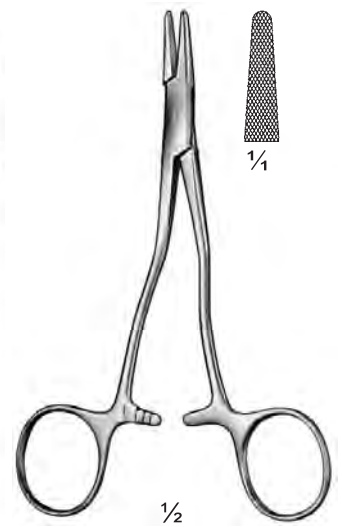

Kilner  
242-14-13  
13.5 cm / 5 1/4"

**Nadelhalter  
Needle Holders  
Porte-aiguilles**

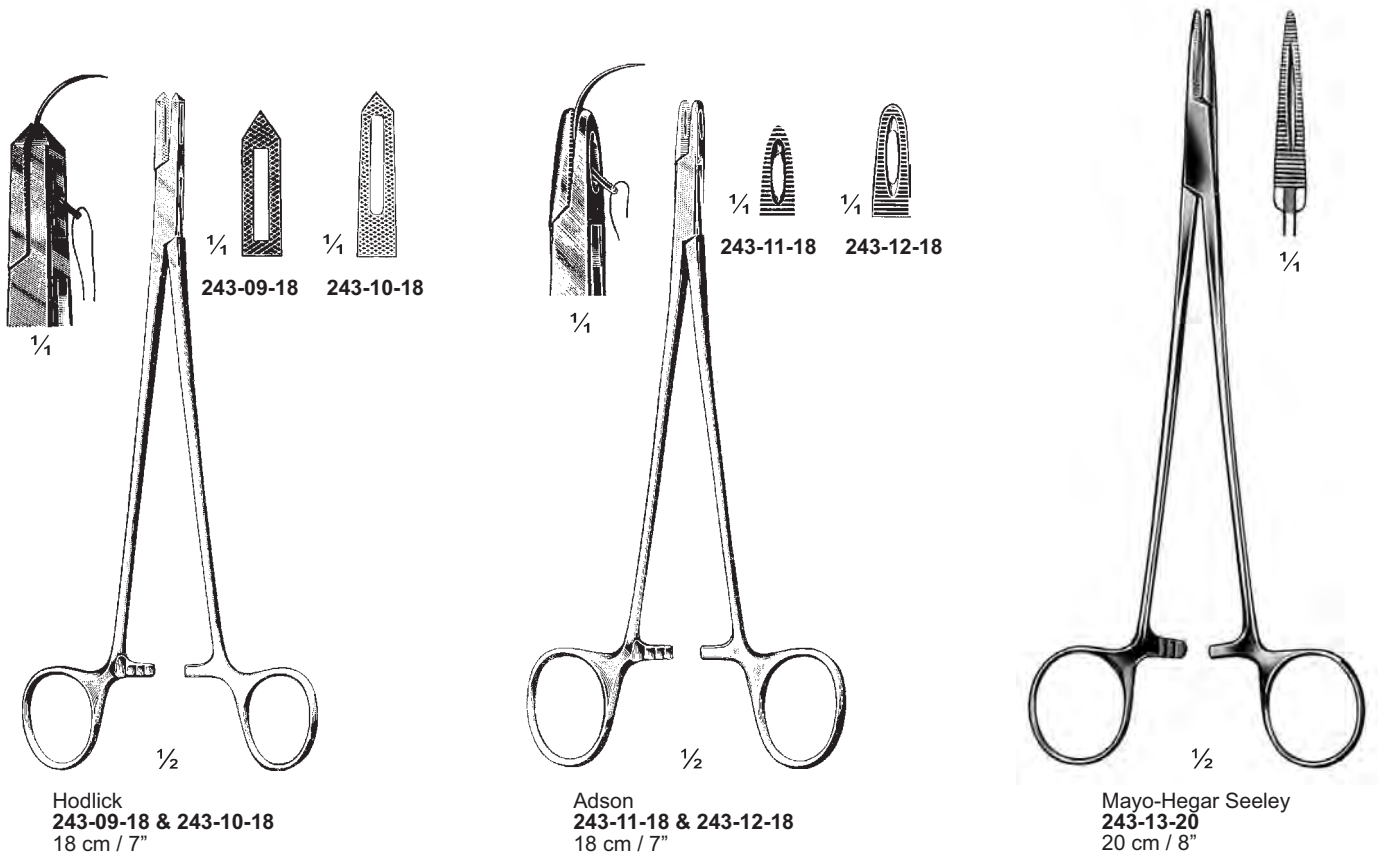
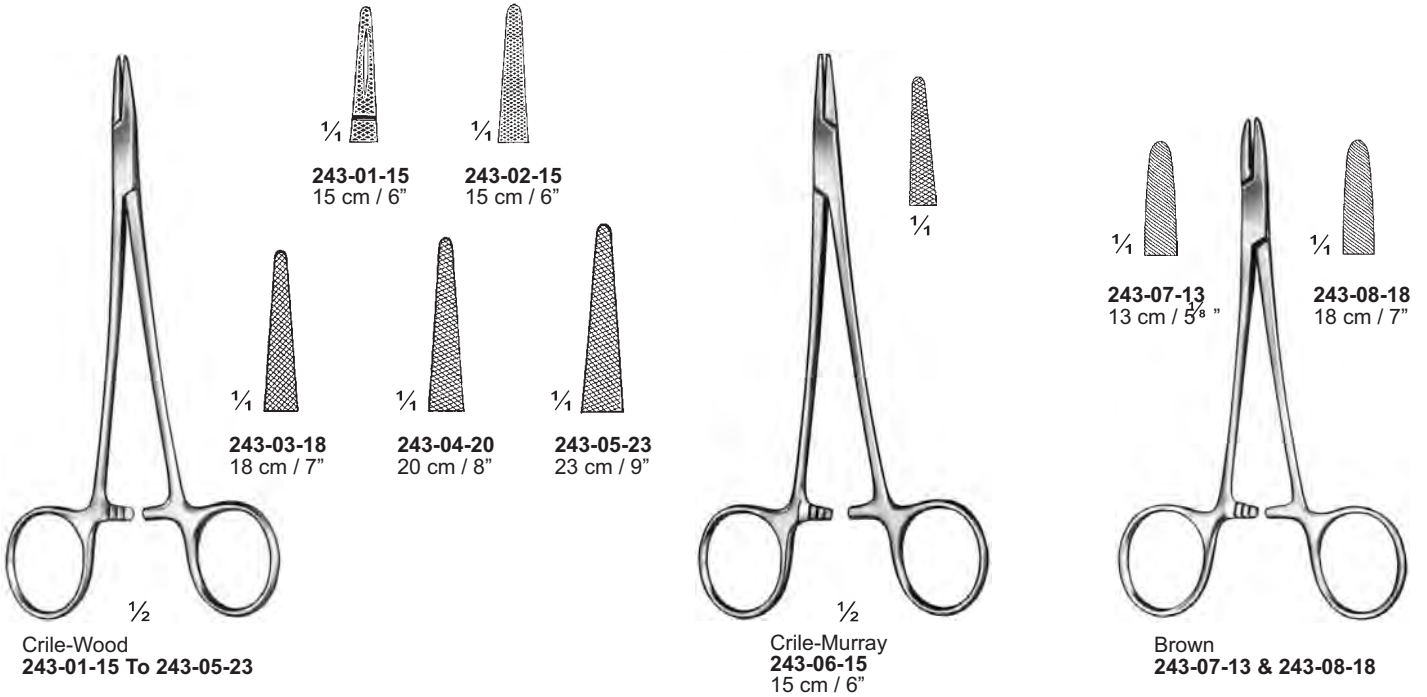



# Nadelhalter Needle Holders Porte-aiguilles

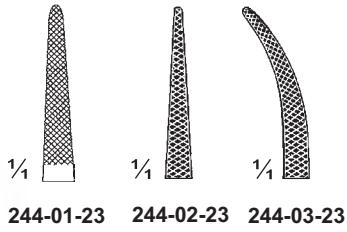

Jamison  
244-01-23 To 244-03-23  
23.5 cm / 9¼"

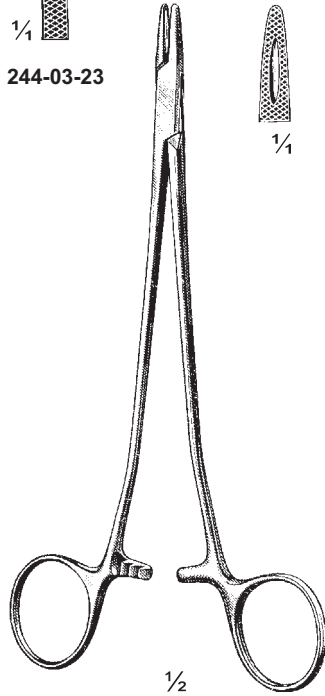

Sarot  
244-04-18 18 cm / 7"  
244-05-26 26 cm / 10¼"

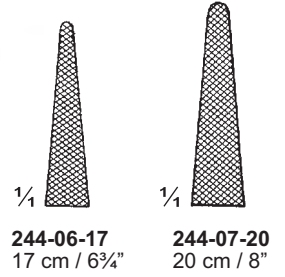
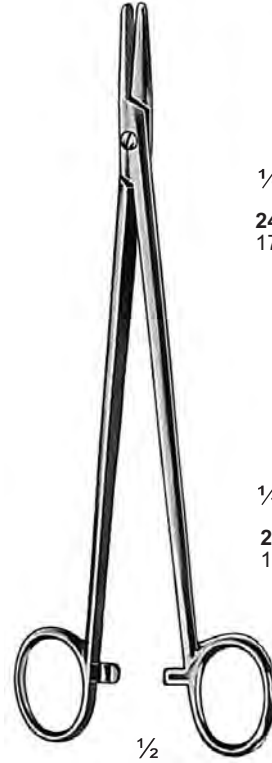

Hegar  
244-06-17 To 244-09-20

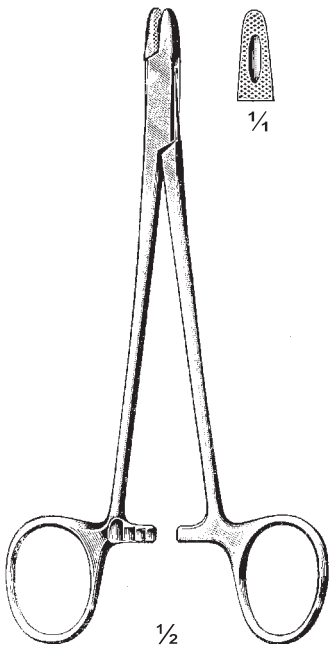
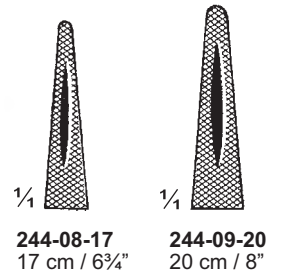

M.G.H.  
(Mass-General-Hospital)  
244-10-17  
17 cm / 6¾"

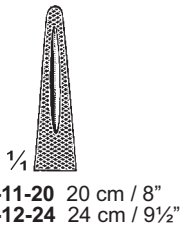
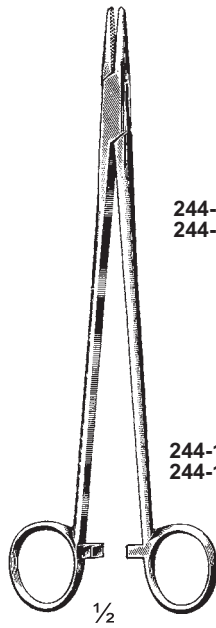

Hegar  
244-11-20 To 244-14-24

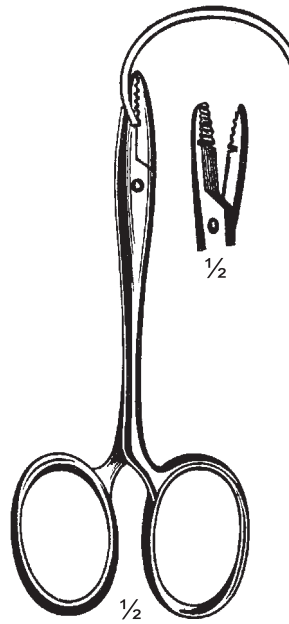
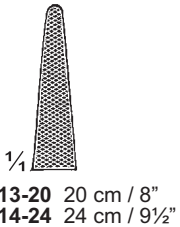

Bruce Clark  
244-15-12 12.5 cm / 5"  
244-16-14 14 cm / 5½"

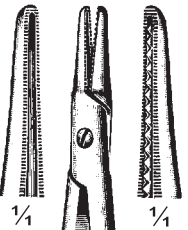
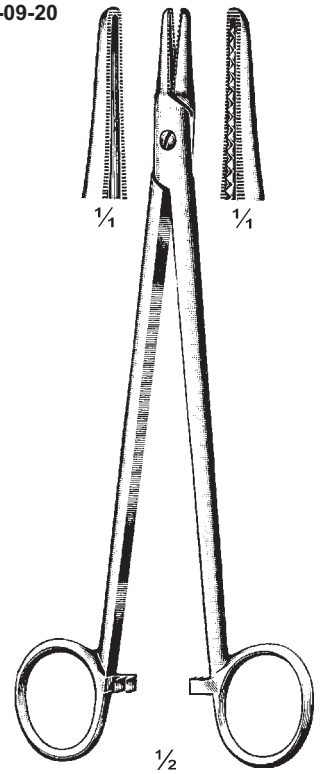

Hegar  
244-17-20  
20 cm / 8"



**Nadelhalter  
Needle Holders  
Porte-aiguilles**

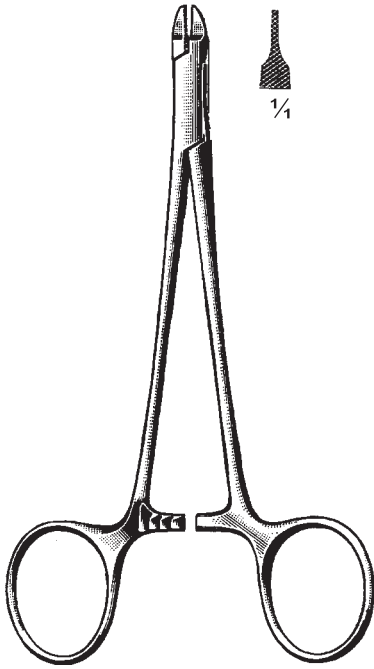

Hufnagel  
245-01-14  
14 cm / 5½"

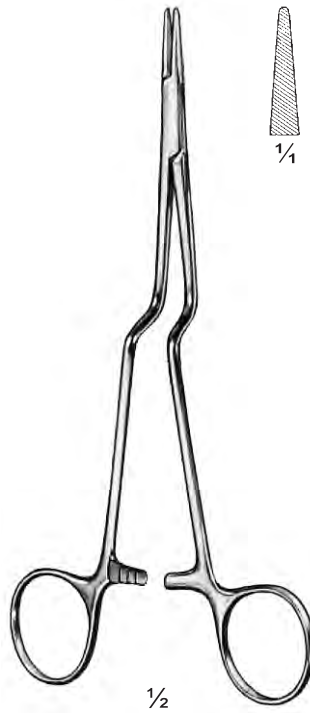

245-02-18 18 cm / 7"  
245-03-21 21 cm / 8¼"  
245-04-24 24 cm / 9½"  
245-05-26 26 cm / 10¼"

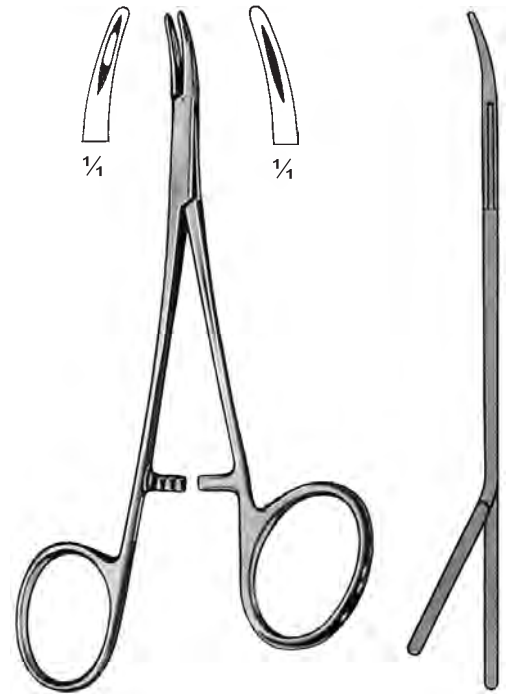

Converse  
245-06-15  
15 cm / 6"



Wertheim  
245-07-20 20 cm / 8"  
245-08-24 24 cm / 9½"



Stratte  
245-09-20 20 cm / 8"  
245-10-24 24 cm / 9½"

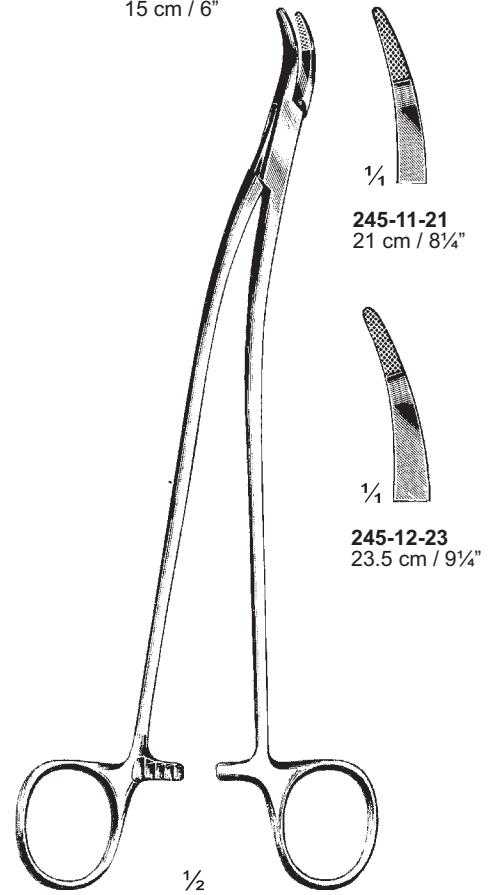

Stratte  
245-11-21 & 245-12-23

245-11-21  
21 cm / 8¼"

245-12-23  
23.5 cm / 9¼"

**Nadelhalter  
Needle Holders  
Porte-aiguilles**

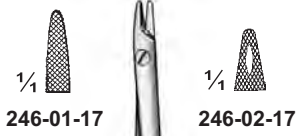

Senning  
246-01-17 & 246-02-17  
17 cm / 6 3/4"

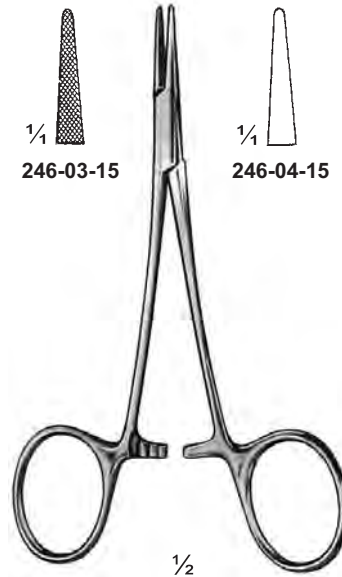
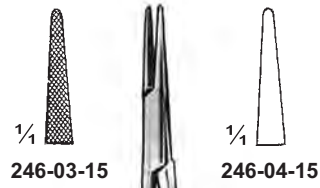

Halstead  
246-03-15 & 246-04-15  
15 cm / 6"

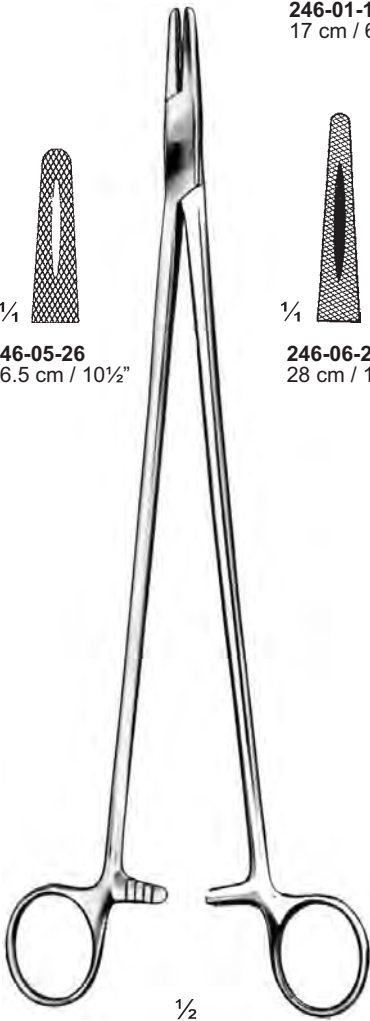
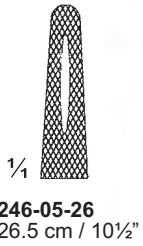

Masson  
246-05-26 & 246-06-28

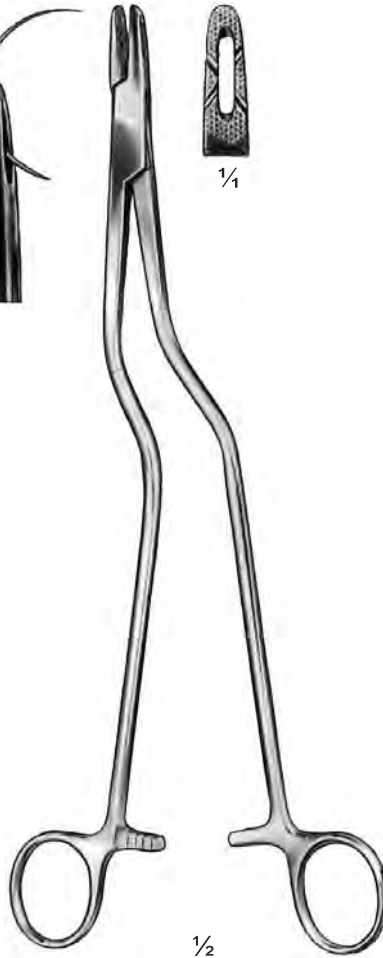
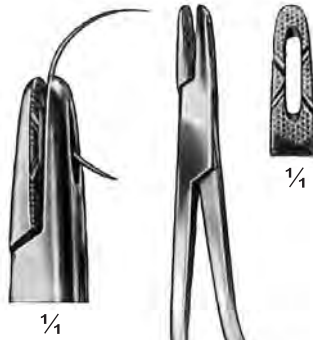
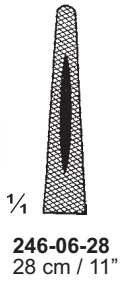

Masson-Luethy  
246-07-25 25 cm / 10"  
246-08-27 27 cm / 10 1/2"

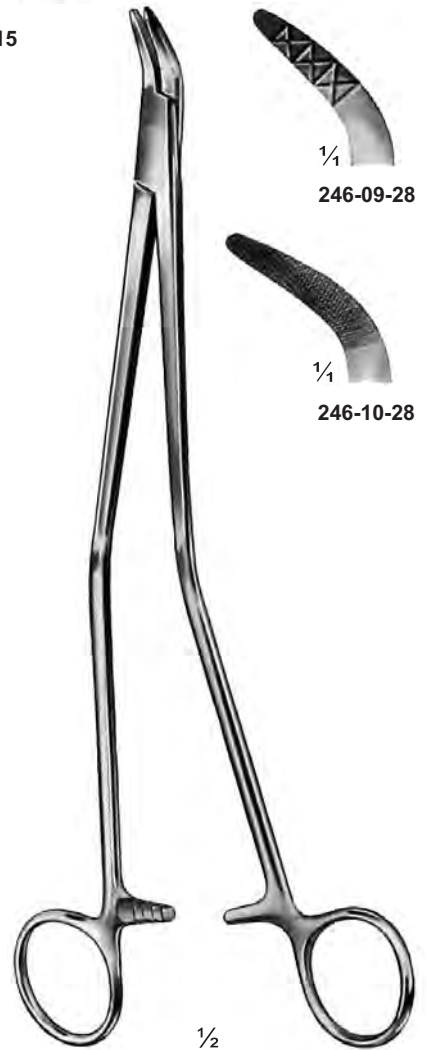

Janson  
246-09-28 & 246-10-28  
28 cm / 11"

**Nadelhalter  
Needle Holders  
Porte-aiguilles**

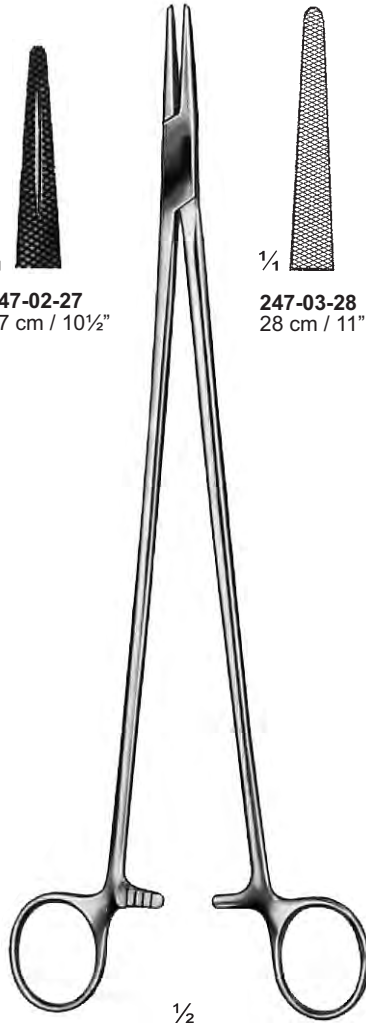
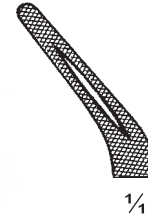
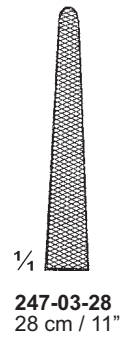
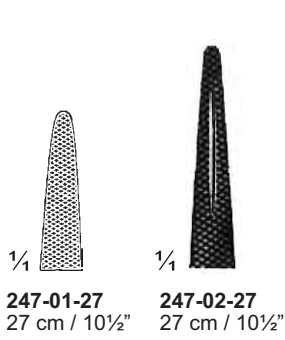

Wangensteen  
247-01-27 To 247-03-28

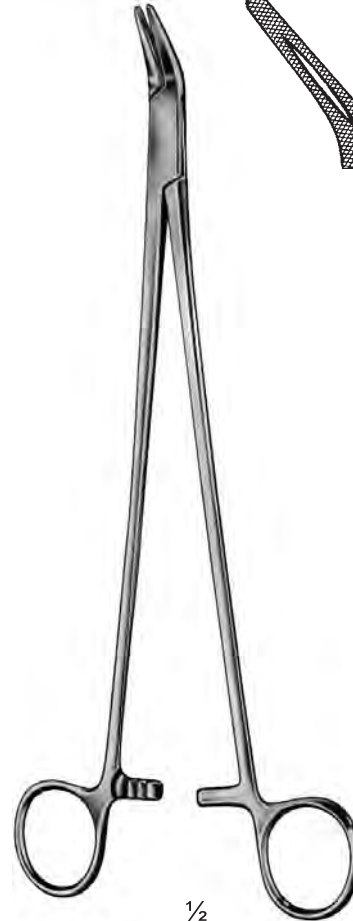

Finochietto  
247-04-27  
27 cm / 10½"

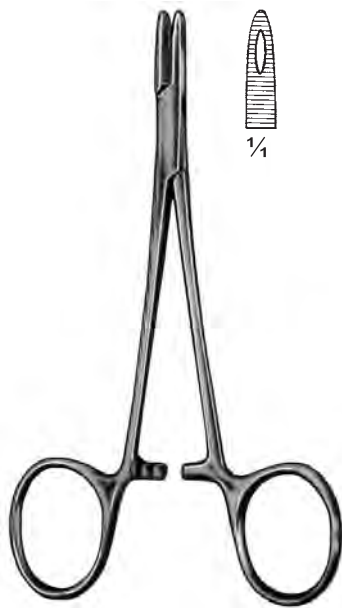

Collier  
247-05-13  
13 cm / 5½"

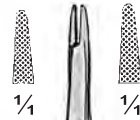

Swiss Mod.  
247-06-14 14.5 cm / 5¾"  
247-07-17 17 cm / 6¾"

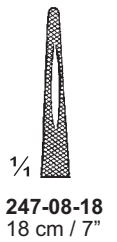

247-09-27  
27 cm / 10½"

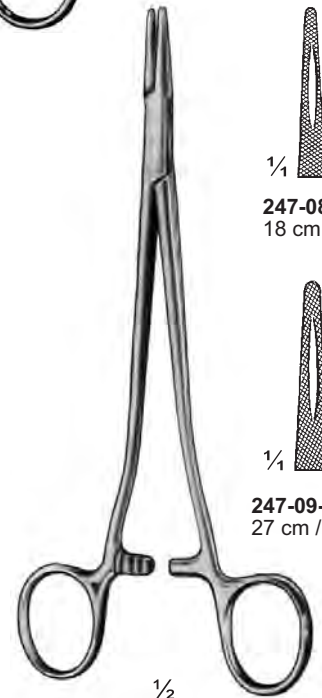

Sarat  
247-08-18 & 247-09-27

**Nadelhalter  
Needle Holders  
Porte-aiguilles**

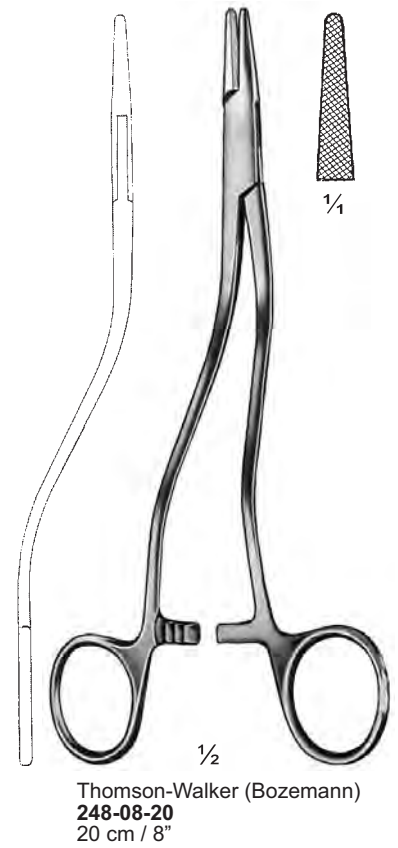
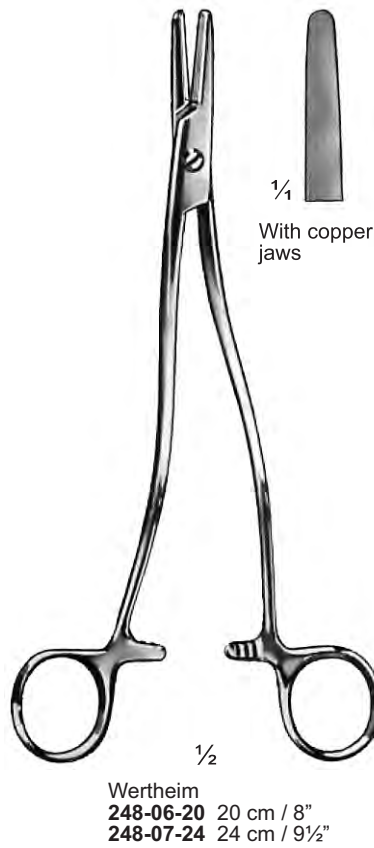
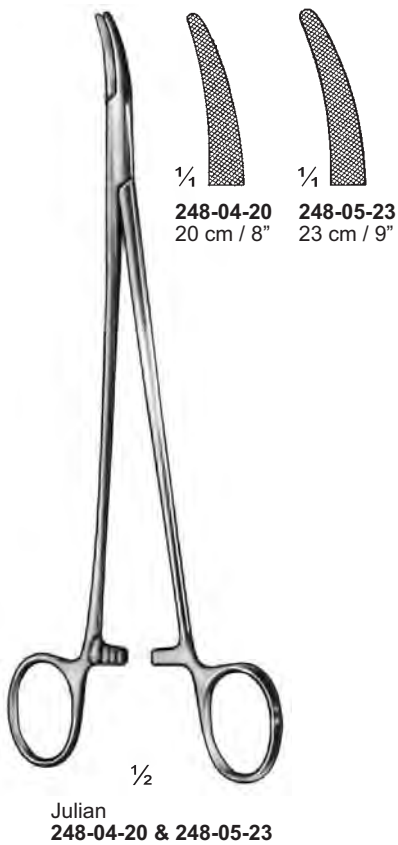

**Nadelhalter  
Needle Holders  
Porte-aiguilles**



Olsen-Hegar  
249-01-12 & 249-02-12  
12 cm / 4 3/4"

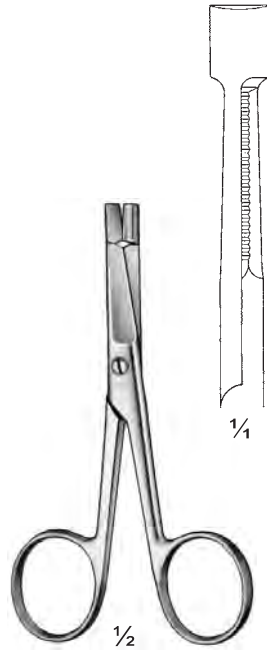

Eiselsberg  
249-03-11  
11.5 cm / 4 1/2"

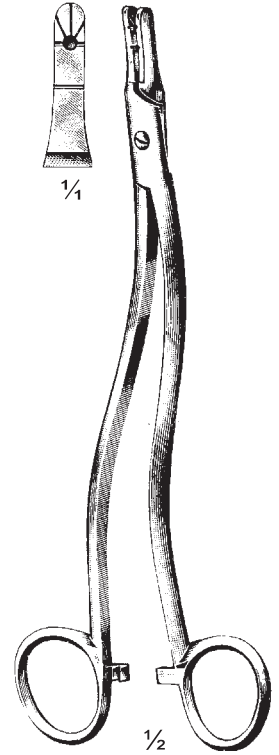

Bozemann  
249-04-20  
20 cm / 8"

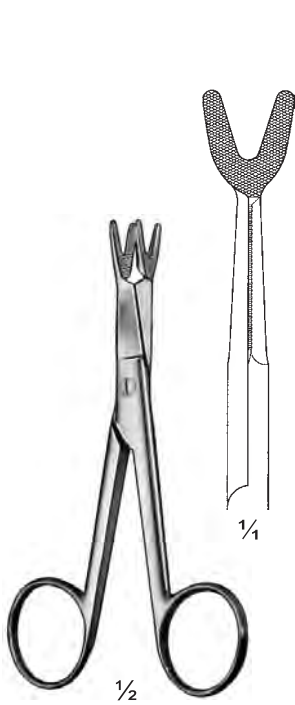

Schoemaker-Loth  
249-05-12  
12.5 cm / 5"

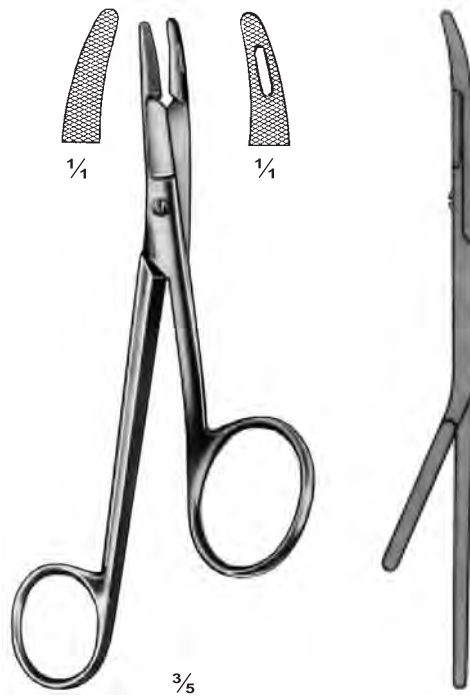

Gillies  
249-06-15  
15.5 cm / 6 1/8"

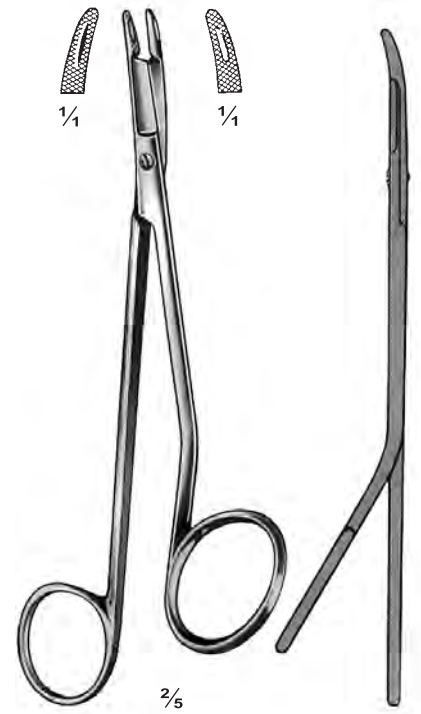

Gillies-Slim  
249-07-14  
14.5 cm / 5 3/4"



# Nadelhalter Needle Holders Porte-aiguilles

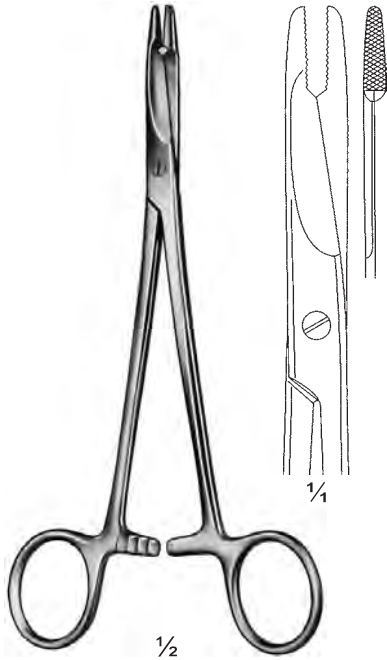

Olsen-Hegar  
250-01-17  
17 cm / 6<sup>3</sup>/<sub>4</sub>"

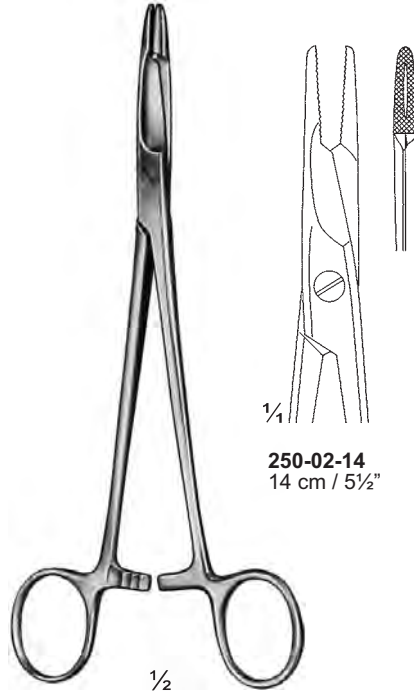

Olsen-Hegar  
250-02-14 & 250-03-18

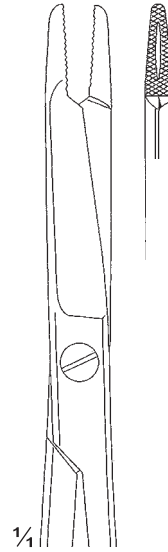

250-03-18  
18 cm / 7"

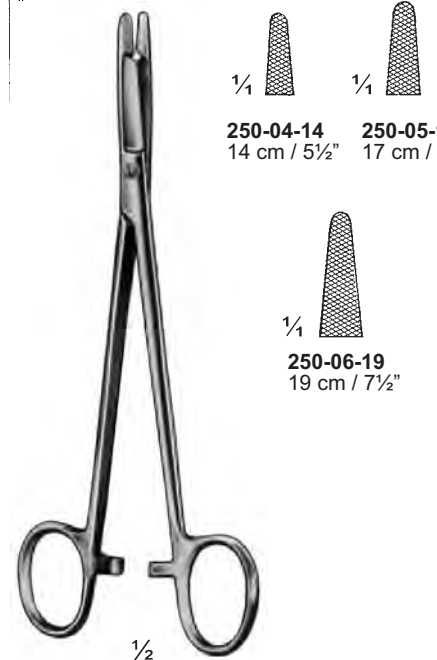

Olsen-Hegar  
250-04-14 To 250-06-19

250-04-14 14 cm / 5<sup>1</sup>/<sub>2</sub>"  
250-05-17 17 cm / 6<sup>3</sup>/<sub>4</sub>"

250-06-19 19 cm / 7<sup>1</sup>/<sub>2</sub>"

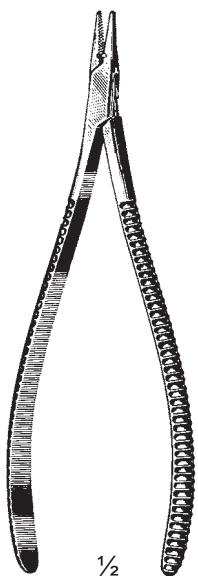

Crile  
250-07-15 To 250-10-19

250-07-15 15 cm / 6"  
250-08-19 19 cm / 7<sup>1</sup>/<sub>2</sub>"

250-09-15 15 cm / 6"  
250-10-19 19 cm / 7<sup>1</sup>/<sub>2</sub>"

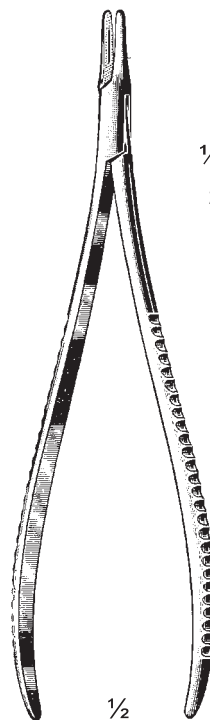

Kirschner  
250-11-18 To 250-13-23

250-11-18 18 cm / 7"  
250-12-20 20 cm / 8"

250-13-23 23 cm / 9"

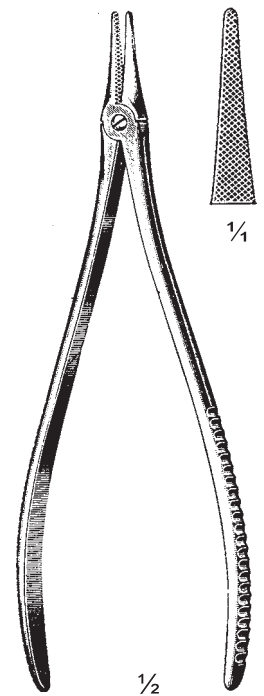

Axhausen  
250-14-18 18.5 cm / 7<sup>1</sup>/<sub>4</sub>"  
250-15-23 23 cm / 9"



# Nadelhalter Needle Holders Porte-aiguilles

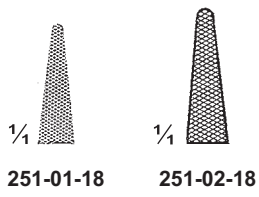
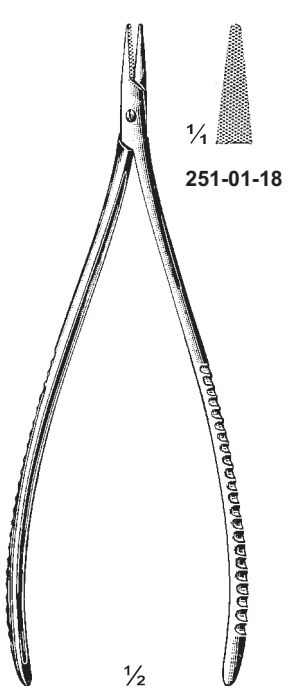

Toennis  
251-01-18 & 251-02-18  
18 cm / 7"

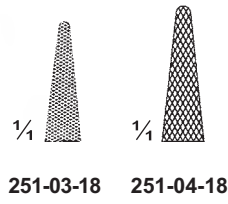

Toennis  
251-03-18 & 251-04-18  
18 cm / 7"

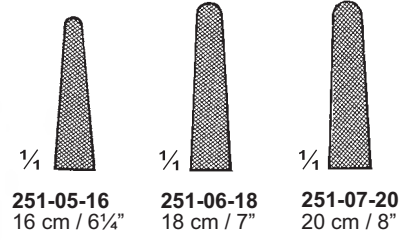

Langenbeck  
251-05-16 To 251-07-20  
16 cm / 6 1/4" 18 cm / 7" 20 cm / 8"

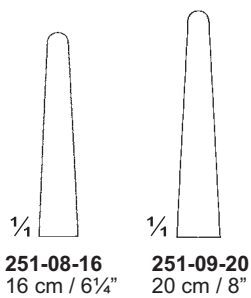
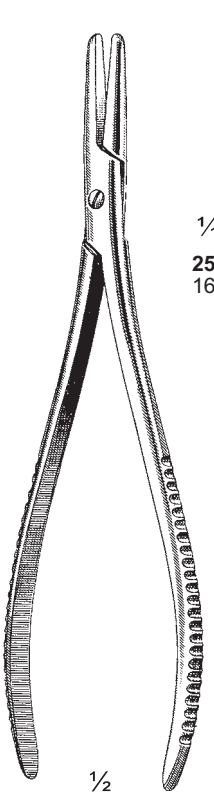

Langenbeck  
251-08-16 & 251-09-20

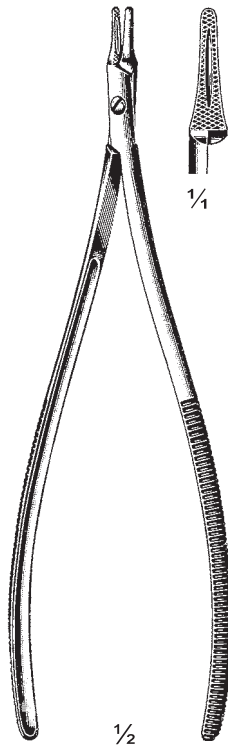

Koenig  
251-10-17 17 cm / 6 3/4"  
251-11-20 20 cm / 8"



Metzbaum-Mathieu  
251-12-17 & 251-13-20  
17 cm / 6 1/4" 20 cm / 8"

# Nadelhalter Needle Holders Porte-aiguilles



Mathieu-Kocher  
252-01-14 To 252-03-20

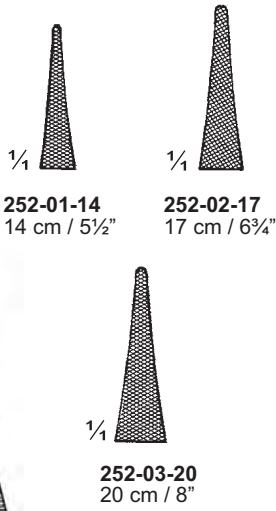

Mathieu  
252-04-14 To 252-10-20

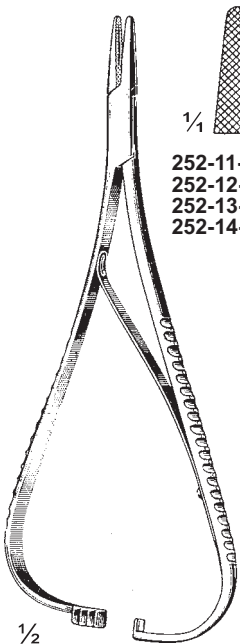
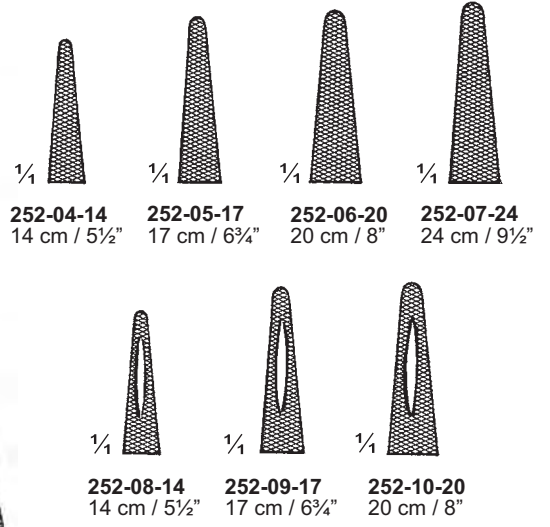

Mathieu  
252-11-14 To 252-18-24

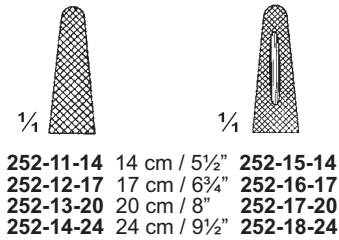

Mathieu  
252-19-17 To 252-22-20

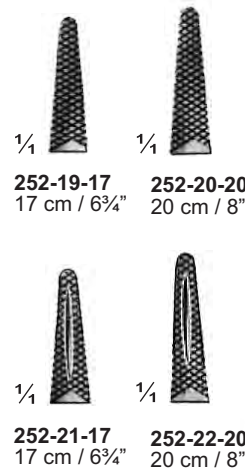

Mathieu  
252-23-17 To 252-25-17

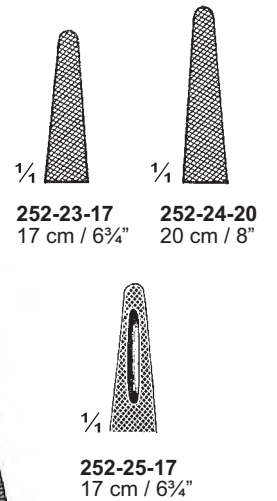

# Nadelhalter Needle Holders Porte-aiguilles

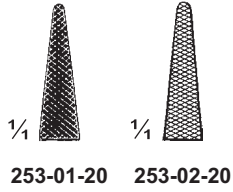
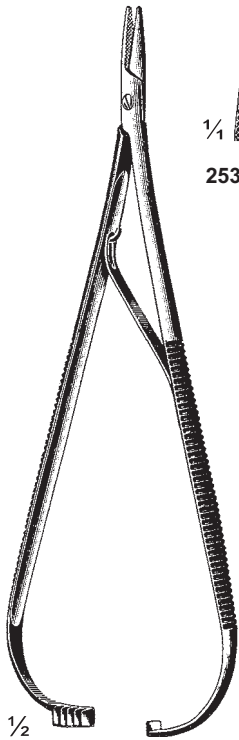

253-01-20 253-02-20

1/2  
Lichtenberg  
253-01-20 & 253-02-20  
20 cm / 8"

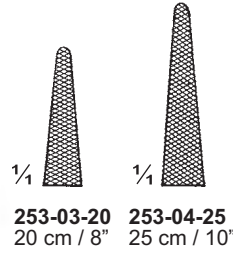

253-03-20 253-04-25  
20 cm / 8" 25 cm / 10"

1/2  
Lichtenberg  
253-03-20 & 253-04-25



1/2  
Mathieu-Sverige  
253-05-17  
17 cm / 6 3/4"

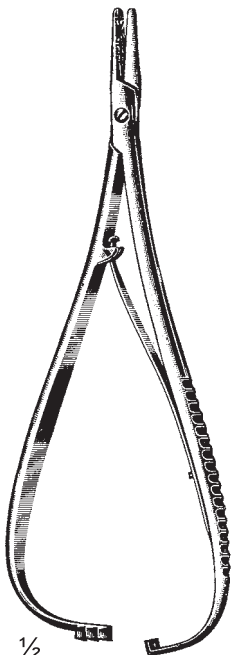

1/2  
Mathieu-Kersten  
253-06-17 17 cm / 6 3/4"  
253-07-20 20 cm / 8"

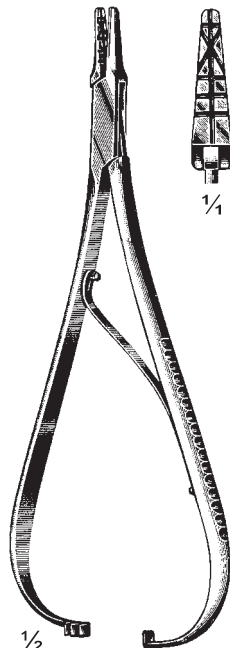

1/2  
Mathieu-Kersten  
253-08-17 17 cm / 6 3/4"  
253-09-20 20 cm / 8"

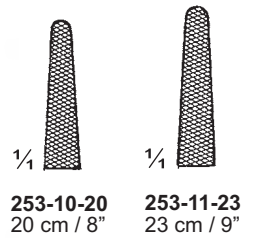

1/2  
Zweifel  
253-10-20 & 253-11-23

# Nadelhalter Needle Holders Porte-aiguilles



Mathieu  
254-01-14 To 254-07-20

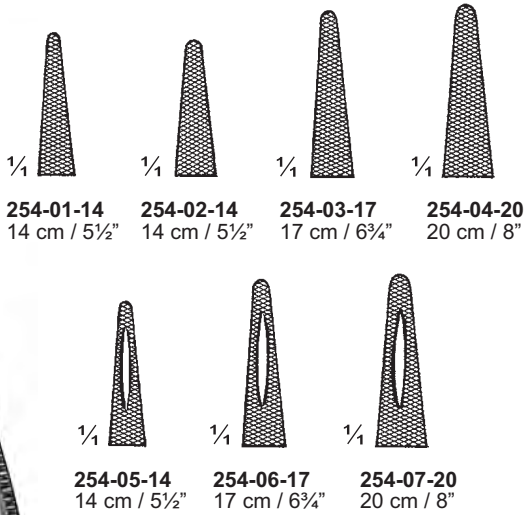

Mathieu  
254-08-14 To 254-13-20

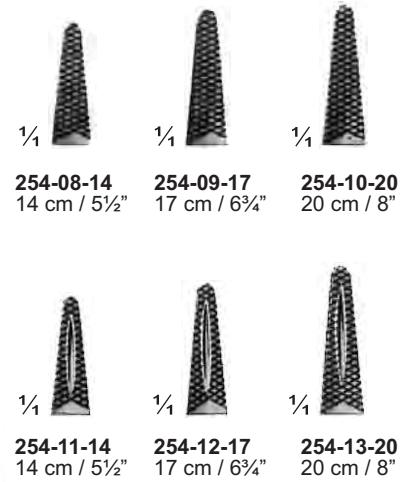

Mathieu-Kocher  
254-14-14 To 254-16-20

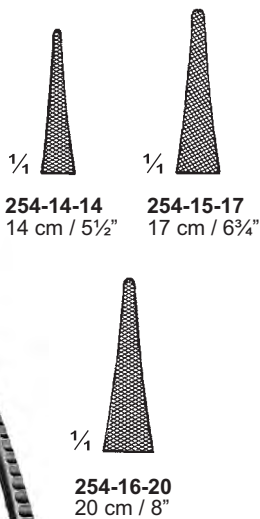

Mathieu-Stille  
254-17-18 & 254-18-20

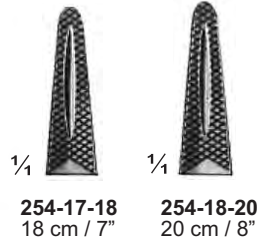

Mathieu-Stille  
254-19-18 & 254-20-20  
Very heavy model

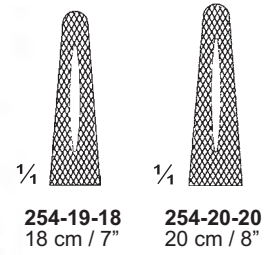

# Nadelhalter Needle Holders Porte-aiguilles

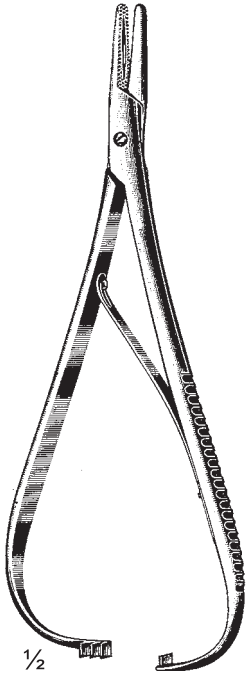

1/2  
Stille  
255-01-18 18 cm / 7"  
255-02-20 20 cm / 8"

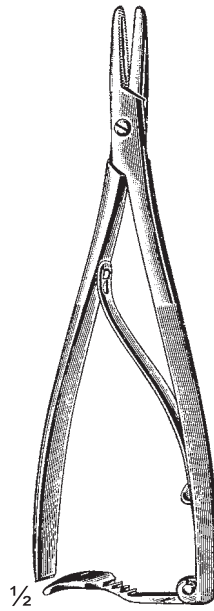

1/2  
Rinne  
255-03-17 To 255-06-20



1/4  
255-03-17 17 cm / 6 3/4"  
255-04-20 20 cm / 8"



1/4  
255-05-17 17 cm / 6 3/4"  
255-06-20 20 cm / 8"

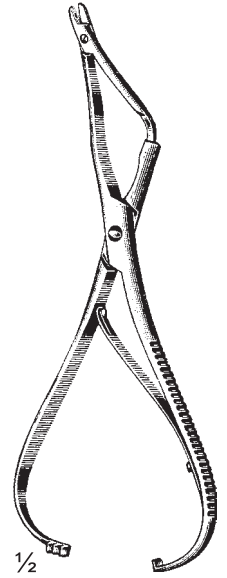

1/2  
Kader-Mathieu  
255-07-15 15 cm / 6"  
255-08-18 18 cm / 7"  
255-09-20 20 cm / 8"  
255-10-23 23 cm / 9"  
255-11-25 25 cm / 10"



1/2  
255-12-20 & 255-13-25



1/4  
255-12-20  
20 cm / 8"



1/4  
255-13-25  
25 cm / 10"

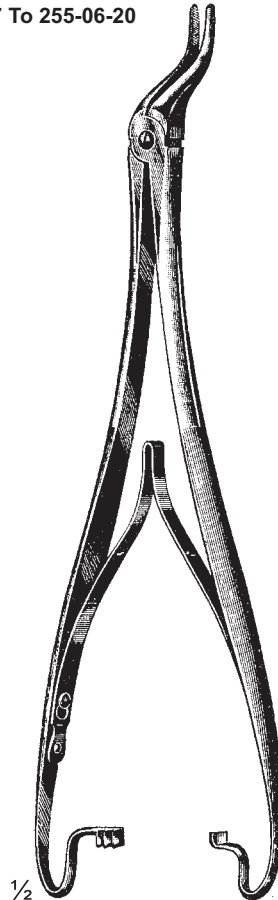

1/2  
Steinbach  
255-14-24 24 cm / 9 1/2"  
255-15-27 27 cm / 10 1/2"

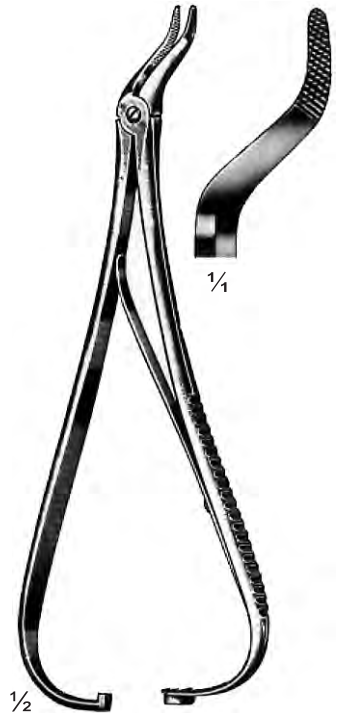

1/2  
Eiselsberg-Mathieu  
255-16-18 18.5 cm / 7 1/4"  
255-17-23 23 cm / 9"  
255-18-25 25 cm / 10"



# Nadelhalter Needle Holders Porte-aiguilles

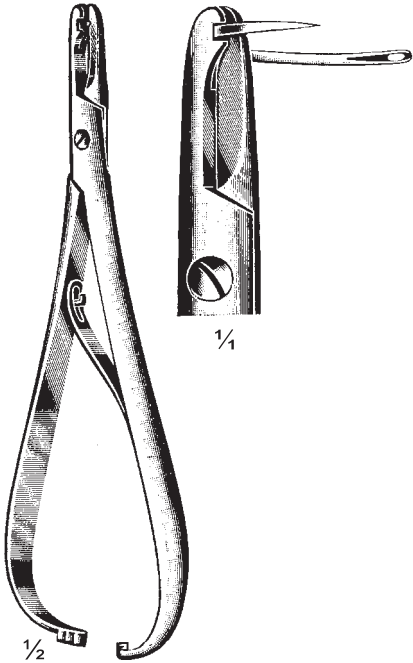

1/2  
Ermold  
256-01-17 17 cm / 6 3/4"  
256-02-20 20 cm / 8"

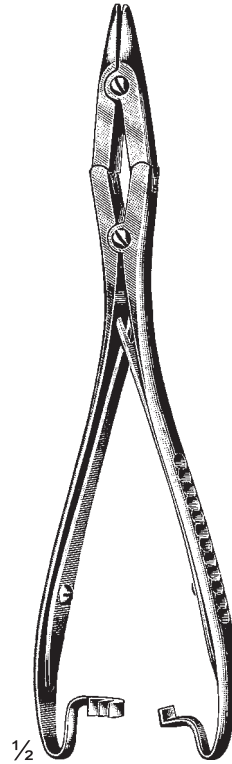

1/2  
256-03-20 To 256-07-25



1/4  
256-03-20  
20 cm / 8"

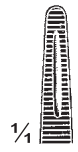

1/4  
256-04-20  
20 cm / 8"



1/4  
256-05-20  
20 cm / 8"



1/4  
256-06-20  
20 cm / 8"

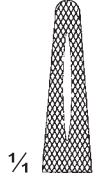

1/4  
256-07-25  
25 cm / 10"

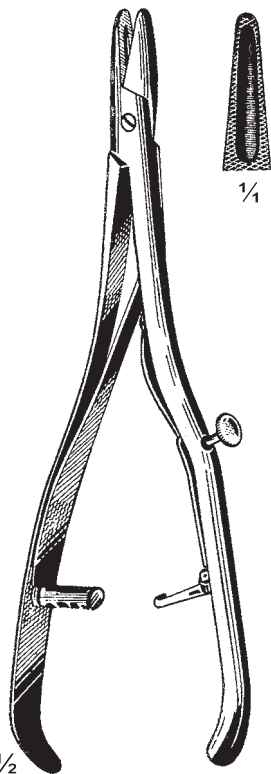

1/2  
Mayo  
256-08-16 16 cm / 6 1/4"  
256-09-18 18 cm / 7"  
256-10-20 20 cm / 8"



1/4

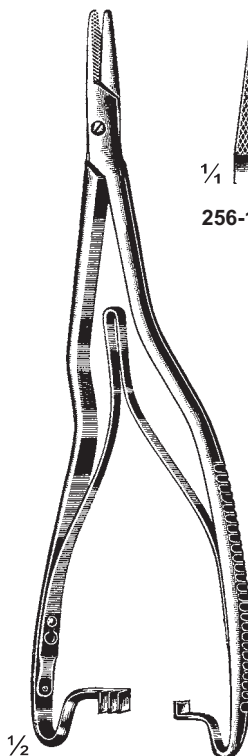

1/2  
Luethy-Beck  
256-11-20 & 256-12-20  
20 cm / 8"



1/4  
256-11-20



1/4  
256-12-20



Hoesel  
256-13-25 & 256-14-25  
25 cm / 10"

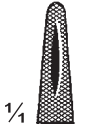

1/4  
256-13-25



1/4  
256-14-25



**Nadelhalter  
Needle Holders  
Porte-aiguilles**

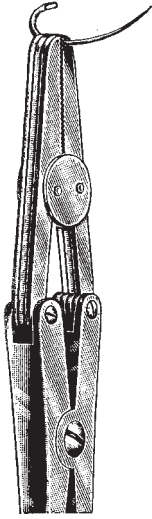

1/4

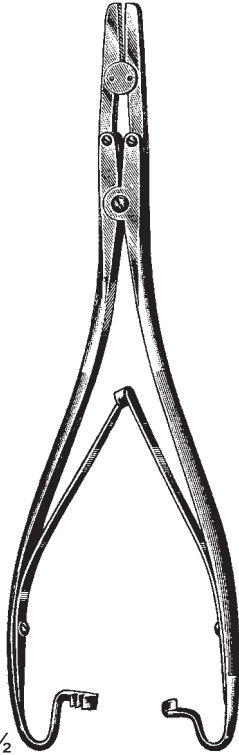

1/2

Wagner  
257-01-20  
20 cm / 8"

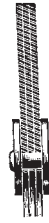

1/2

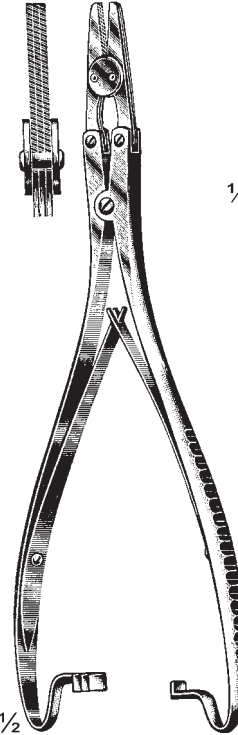

Wagner  
257-02-20  
20 cm / 8"

1/4

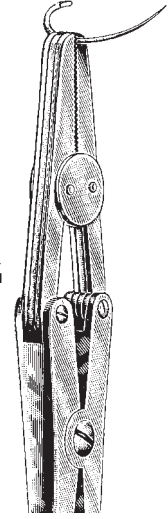

1/4

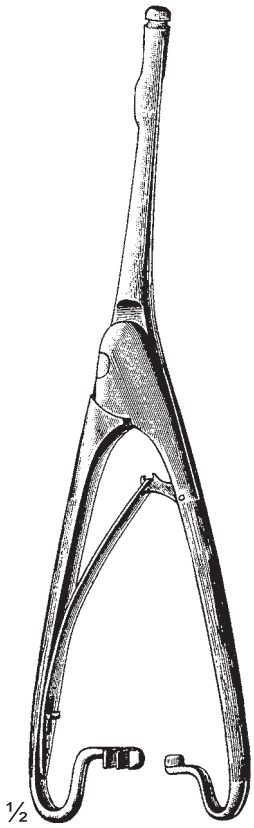

1/2

Hagedorn  
257-03-20  
20 cm / 8"



1/4

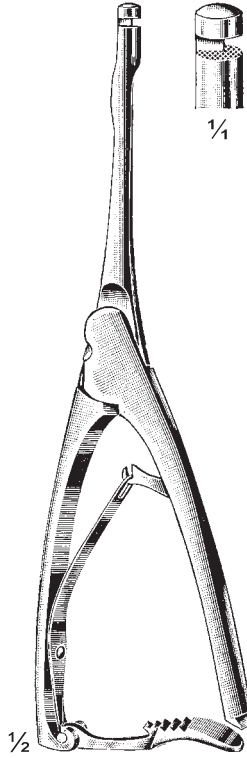

1/2

Hagedorn  
257-04-20  
20 cm / 8"

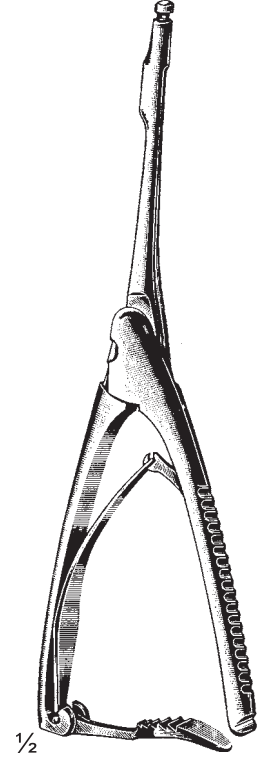

1/2

Hagedorn  
257-05-20  
20 cm / 8"

## Nadelhalter mit Hartmetalleinlagen Needle Holder with Tungsten Carbide Inserts Porte-aiguilles avec inserts en carbure tungstène

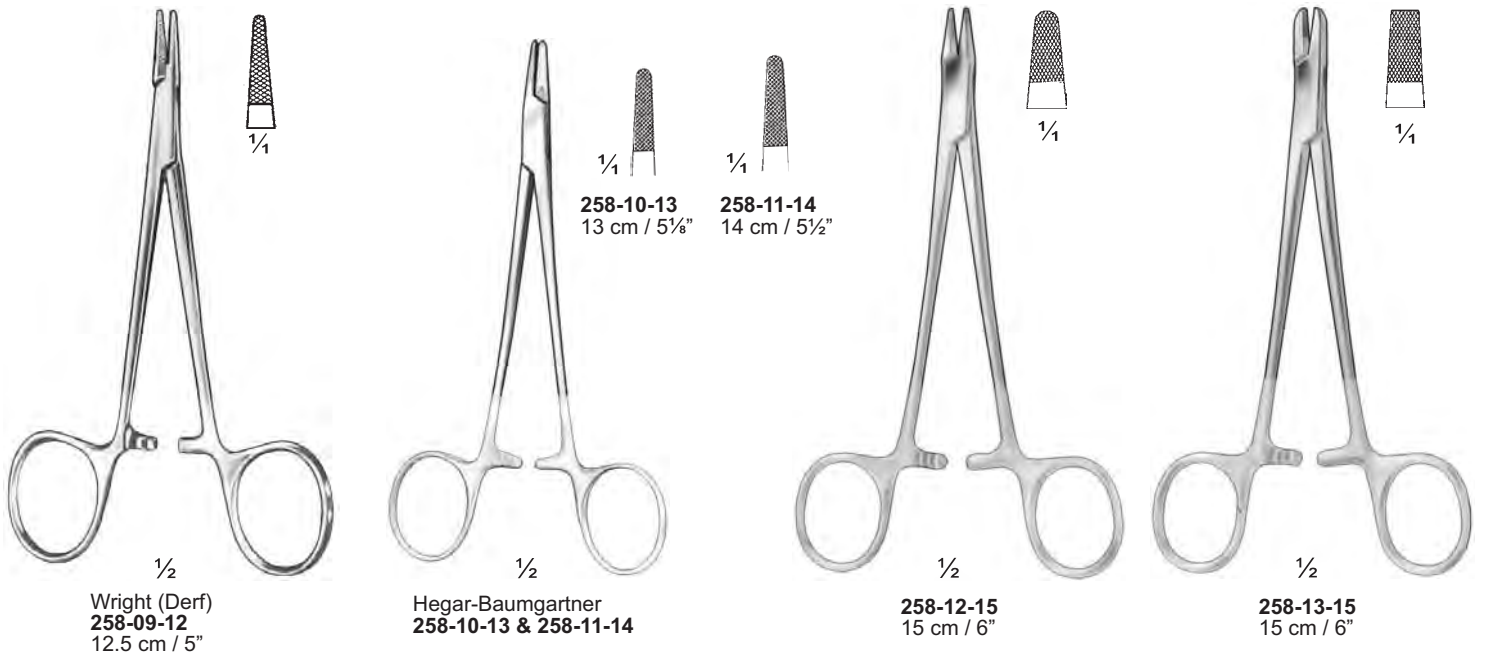
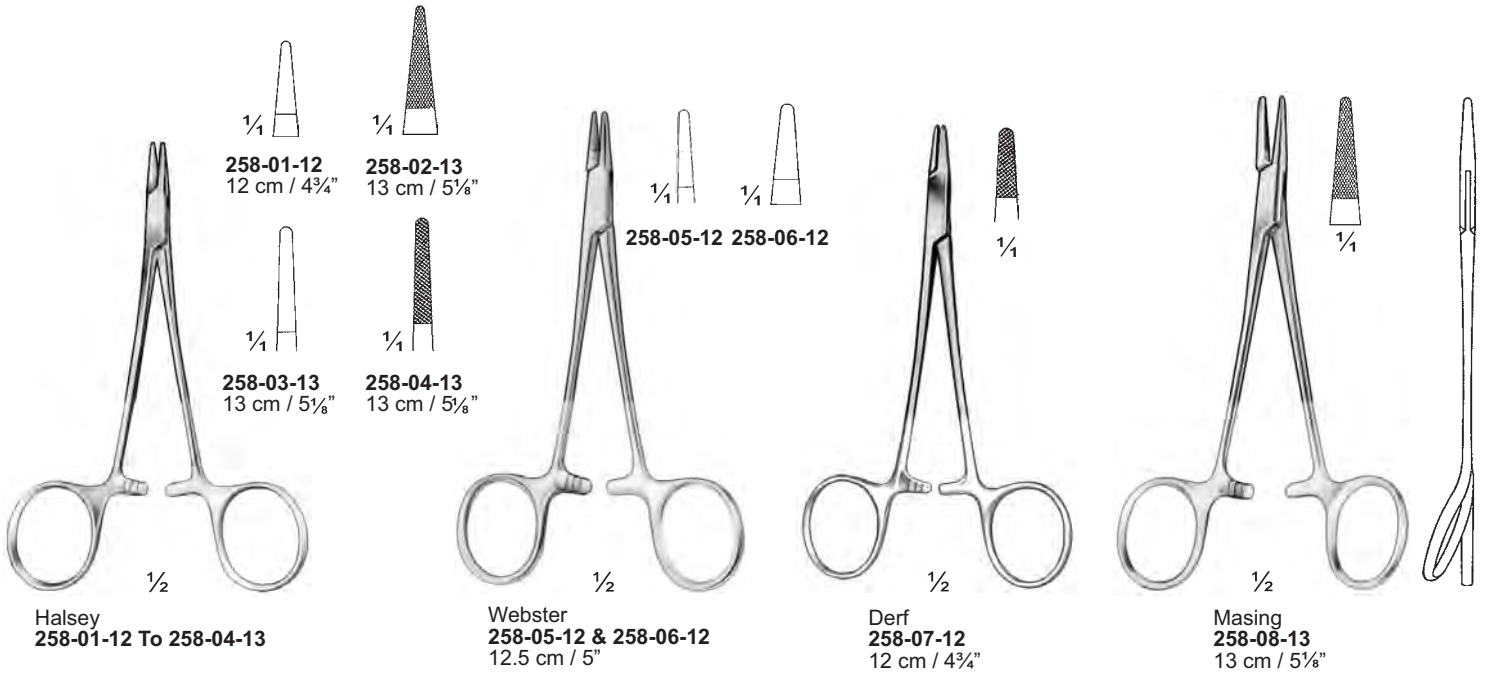

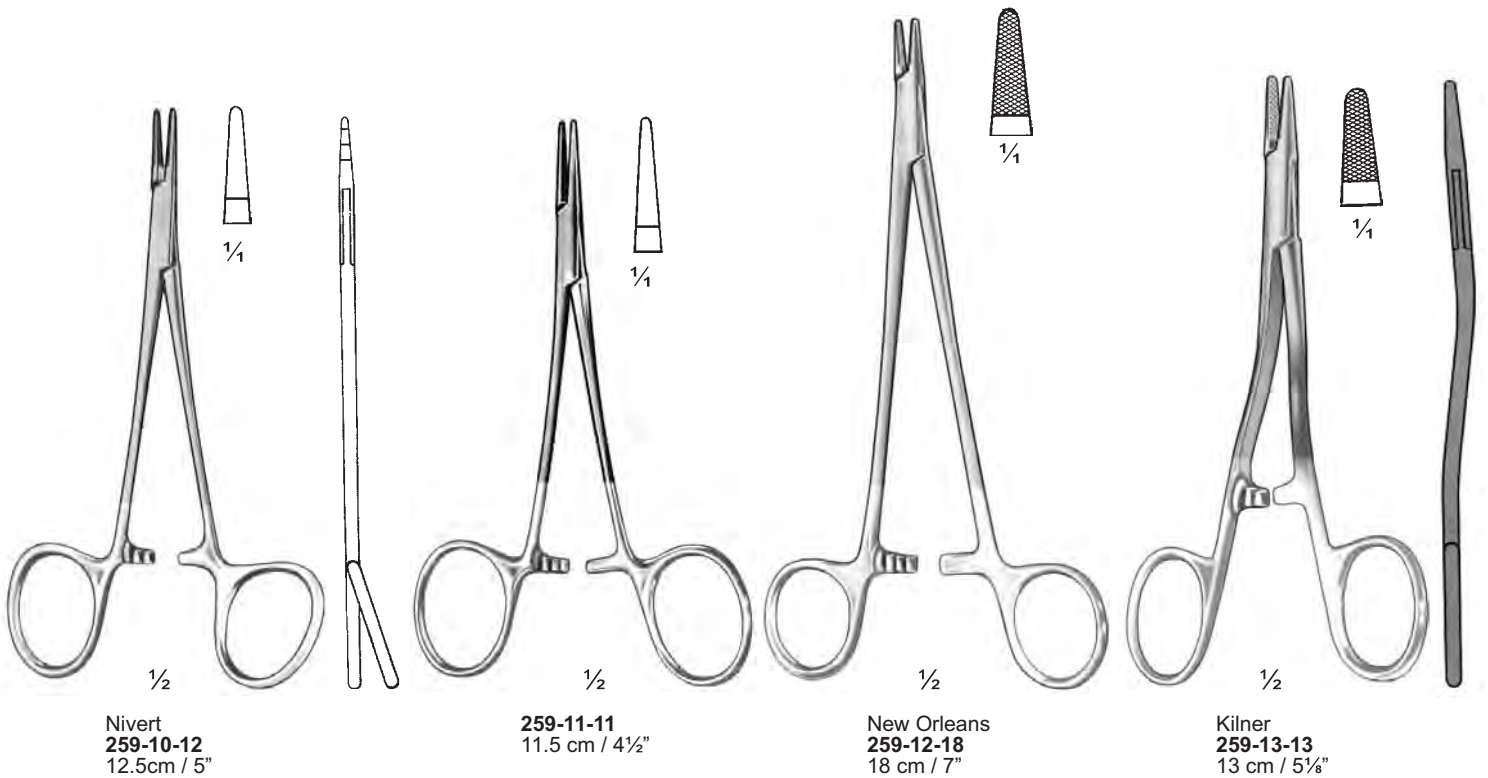
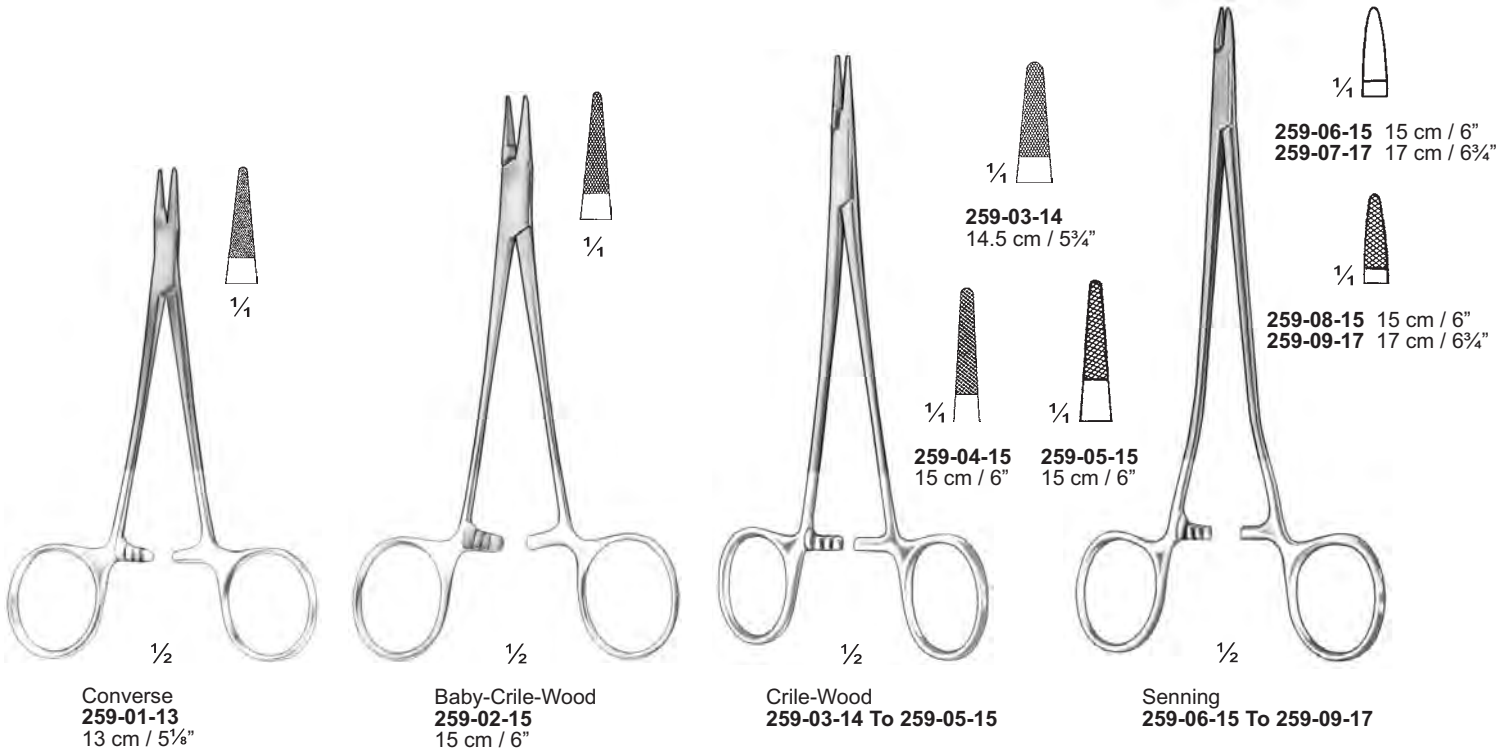

## Nadelhalter mit Hartmetalleinlagen Needle Holder with Tungsten Carbide Inserts Porte-aiguilles avec inserts en carbure tungstène

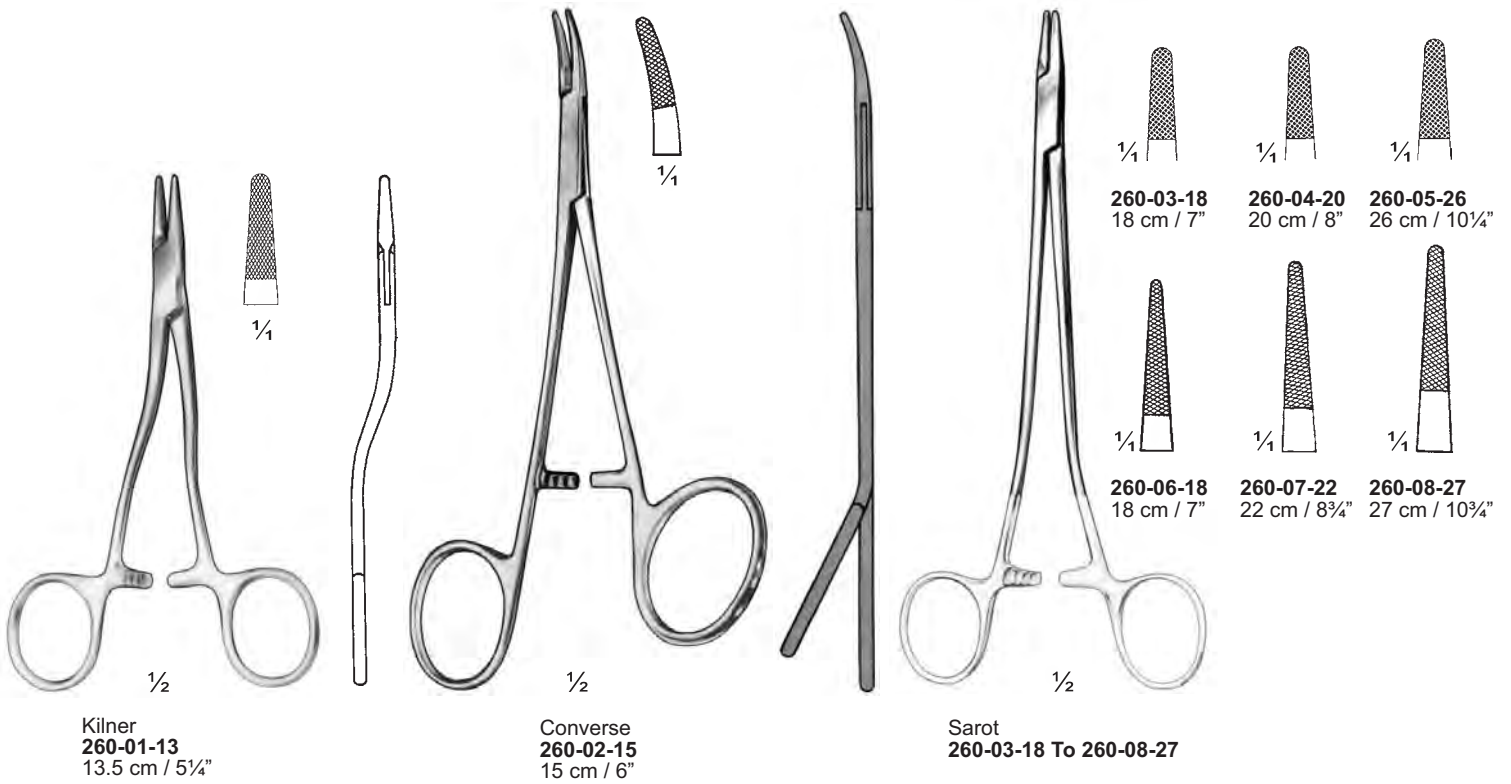

## Nadelhalter mit Hartmetalleinlagen Needle Holder with Tungsten Carbide Inserts Porte-aiguilles avec inserts en carbure tungstène

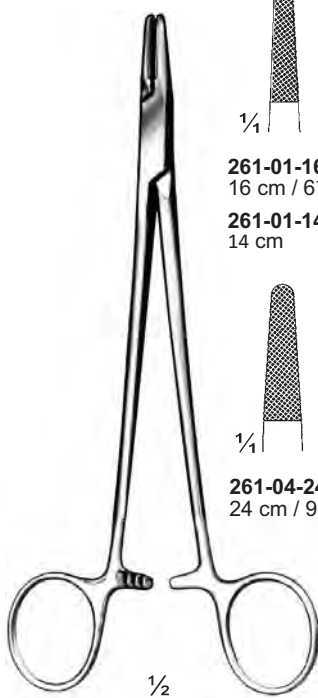
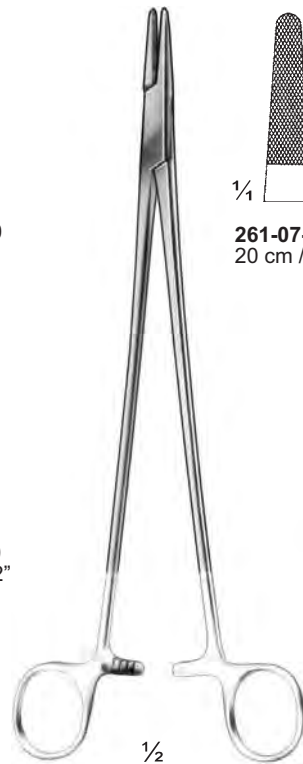
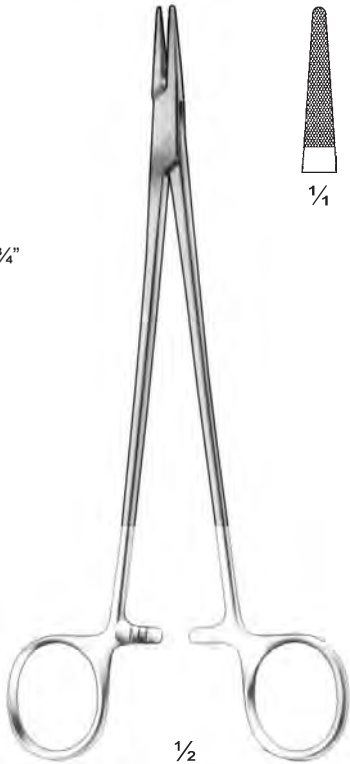
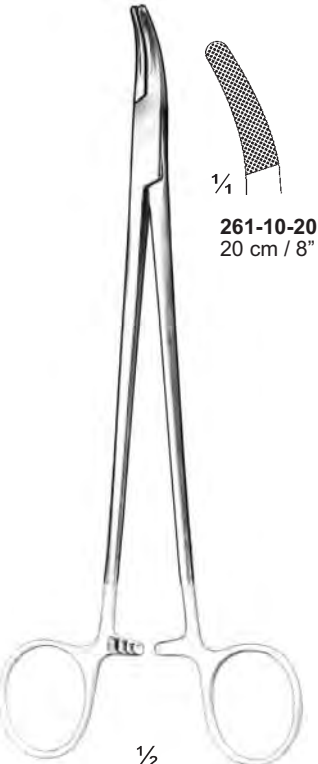
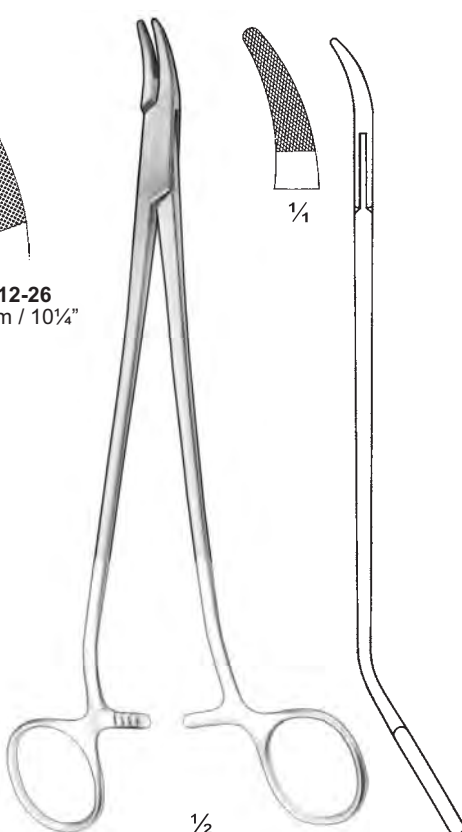

## Nadelhalter mit Hartmetalleinlagen Needle Holder with Tungsten Carbide Inserts Porte-aiguilles avec inserts en carbure tungstène

 <p style="text-align: center;">1/4</p> <p style="text-align: center;">261-01-16 16 cm / 6 1/4"</p> <p style="text-align: center;">261-02-18 18 cm / 7"</p> <p style="text-align: center;">261-03-20 20 cm / 8"</p> <p style="text-align: center;">261-01-14 14 cm</p> <p style="text-align: center;">1/4</p> <p style="text-align: center;">261-04-24 24 cm / 9 1/2"</p> <p style="text-align: center;">261-05-26 26 cm / 10 1/4"</p> <p style="text-align: center;">261-06-30 30 cm / 12"</p> <p style="text-align: center;">1/2</p> <p>Mayo-Hegar 261-01-14 To 261-06-30</p>	 <p style="text-align: center;">1/4</p> <p style="text-align: center;">261-07-20 20 cm / 8"</p> <p style="text-align: center;">261-08-24 24.5 cm / 9 3/4"</p> <p style="text-align: center;">1/4</p> <p style="text-align: center;">261-09-20 20 cm / 8"</p> <p style="text-align: center;">1/2</p> <p>Hegar 261-07-20 &amp; 261-08-24</p>	 <p style="text-align: center;">1/4</p> <p style="text-align: center;">261-09-20 20 cm / 8"</p> <p style="text-align: center;">1/2</p> <p>Mayo-Hegar-Seeley 261-09-20 20 cm / 8"</p>
 <p style="text-align: center;">1/4</p> <p style="text-align: center;">261-10-20 20 cm / 8"</p> <p style="text-align: center;">261-11-24 24 cm / 9 1/2"</p> <p style="text-align: center;">261-12-26 26 cm / 10 1/4"</p> <p style="text-align: center;">1/4</p> <p style="text-align: center;">261-10-20 20 cm / 8"</p> <p style="text-align: center;">261-11-24 24 cm / 9 1/2"</p> <p style="text-align: center;">261-12-26 26 cm / 10 1/4"</p> <p style="text-align: center;">1/2</p> <p>Mayo-Hegar (Heaney) 261-10-20 To 261-12-26</p>	 <p style="text-align: center;">1/4</p> <p style="text-align: center;">261-13-21 21.5 cm / 8 1/2"</p> <p style="text-align: center;">1/2</p> <p>261-13-21 21.5 cm / 8 1/2"</p>	 <p style="text-align: center;">1/4</p> <p style="text-align: center;">261-14-20 20 cm / 8"</p> <p style="text-align: center;">261-15-23 23 cm / 9"</p> <p style="text-align: center;">1/4</p> <p style="text-align: center;">261-14-20 20 cm / 8"</p> <p style="text-align: center;">261-15-23 23 cm / 9"</p> <p style="text-align: center;">1/2</p> <p>Julian 261-14-20 &amp; 261-15-23</p>



## Nadelhalter mit Hartmetalleinlagen Needle Holder with Tungsten Carbide Inserts Porte-aiguilles avec inserts en carbure tungstène

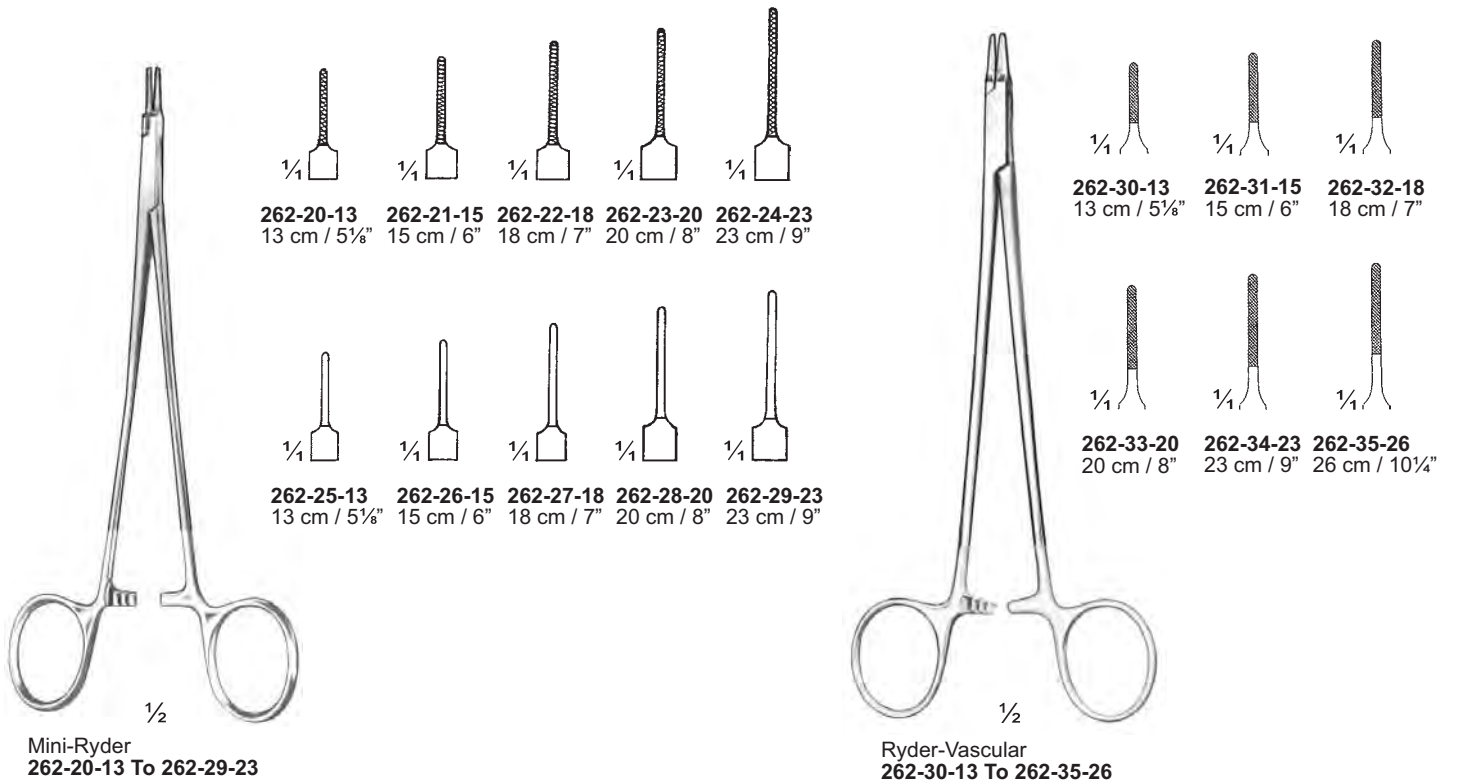
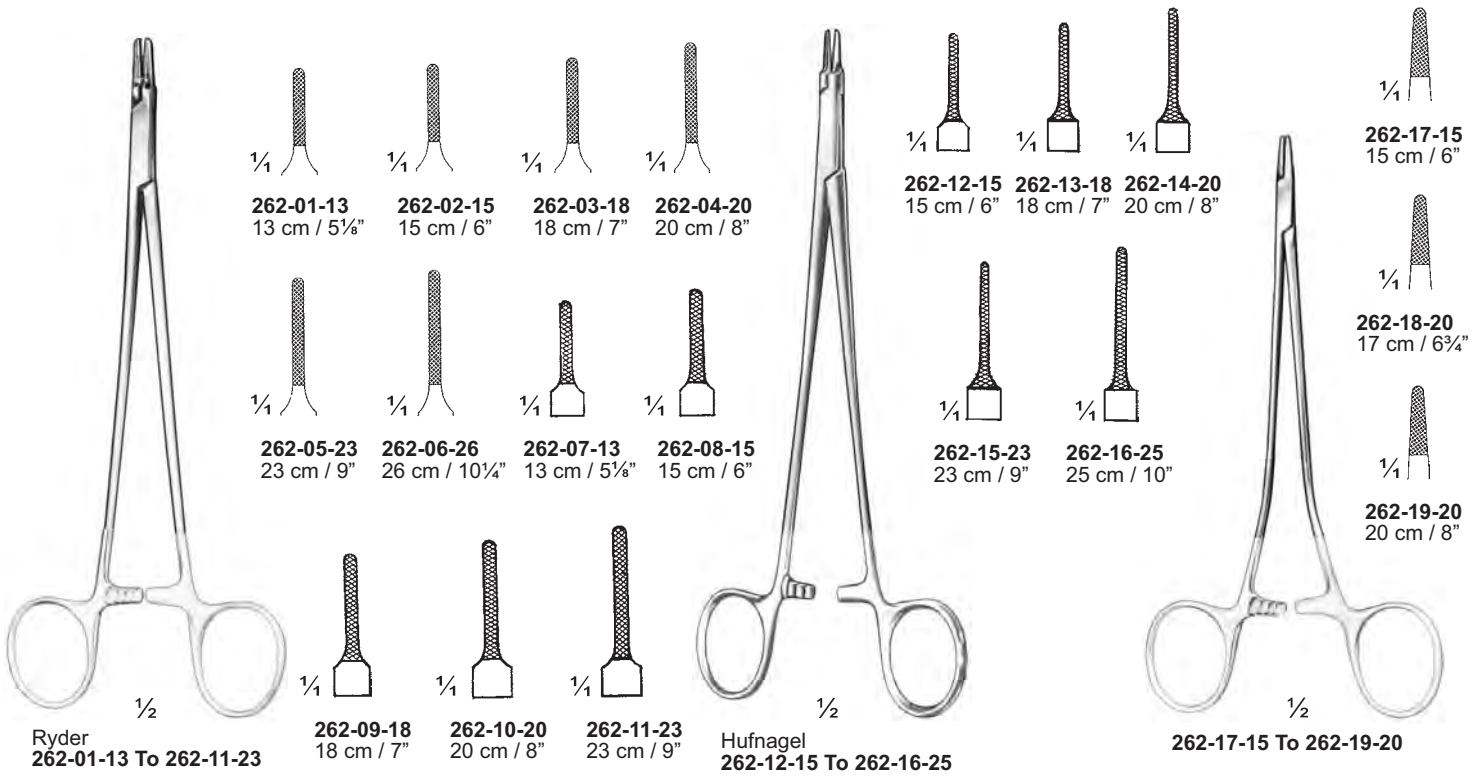



# Nadelhalter mit Hartmetalleinlagen

## Needle Holder with Tungsten Carbide Inserts

### Porte-aiguilles avec inserts en carbure tungstène

**Intracardiac**  
263-01-15 To 263-03-20

**Hegar-Vascular**  
263-04-14 To 263-07-23

**Micro-Slim**  
263-08-15 To 263-15-23

**Intracardiac**  
263-16-14 To 263-19-20

**Wertheim**  
263-20-20 To 263-23-30

**Stratte**  
263-24-21 & 263-25-23

**263-01-15** 15 cm / 6"  $\frac{1}{4}$

**263-02-17** 17 cm / 6 $\frac{3}{4}$ "  $\frac{1}{4}$

**263-03-20** 20 cm / 8"  $\frac{1}{4}$

**263-04-14** 14 cm / 5 $\frac{1}{2}$ "  $\frac{1}{4}$

**263-05-18** 18 cm / 7"  $\frac{1}{4}$

**263-06-20** 20 cm / 8"  $\frac{1}{4}$

**263-07-23** 23 cm / 9"  $\frac{1}{4}$

**263-08-15** 15 cm / 6"  $\frac{1}{4}$

**263-09-18** 18 cm / 7"  $\frac{1}{4}$

**263-10-20** 20 cm / 8"  $\frac{1}{4}$

**263-11-23** 23 cm / 9"  $\frac{1}{4}$

**263-12-15** 15 cm / 6"  $\frac{1}{4}$

**263-13-18** 18 cm / 7"  $\frac{1}{4}$

**263-14-20** 20 cm / 8"  $\frac{1}{4}$

**263-15-23** 23 cm / 9"  $\frac{1}{4}$

**263-16-14** 14 cm / 5 $\frac{1}{2}$ "  $\frac{1}{4}$

**263-17-20** 20 cm / 8"  $\frac{1}{4}$

**263-18-14** 14 cm / 5 $\frac{1}{2}$ "  $\frac{1}{4}$

**263-19-20** 20 cm / 8"  $\frac{1}{4}$

**263-20-20** 20 cm / 8"  $\frac{1}{4}$

**263-21-24** 24 cm / 9 $\frac{1}{2}$ "  $\frac{1}{4}$

**263-22-26** 26 cm / 10 $\frac{1}{4}$ "  $\frac{1}{4}$

**263-23-30** 30 cm / 12"  $\frac{1}{4}$

**263-24-21** 21 cm / 8 $\frac{1}{4}$ "  $\frac{1}{4}$

**263-25-23** 23 cm / 9"  $\frac{1}{4}$

**Nadelhalter mit Hartmetalleinlagen**  
**Needle Holder with Tungsten Carbide Inserts**  
**Porte-aiguilles avec inserts en carbure tungstène**

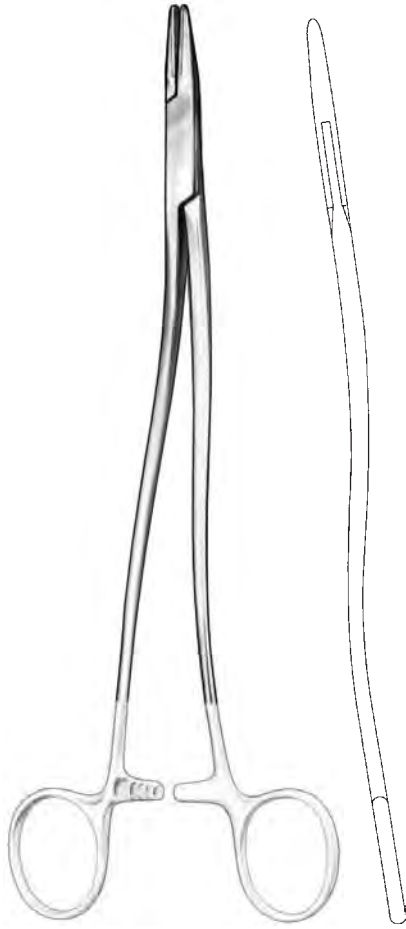

**Bozemann**  
**264-01-20 To 264-03-26**

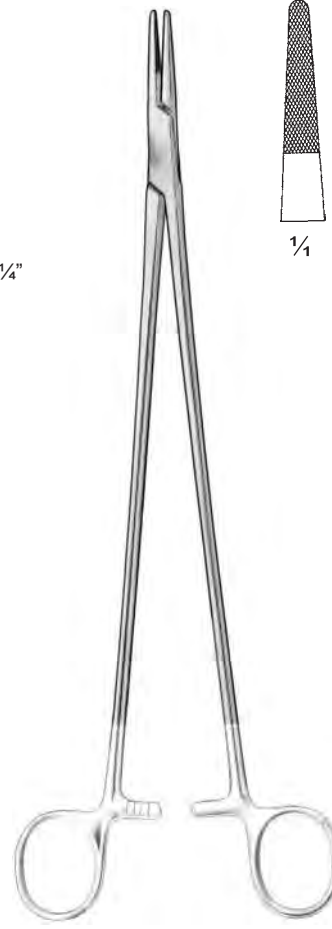
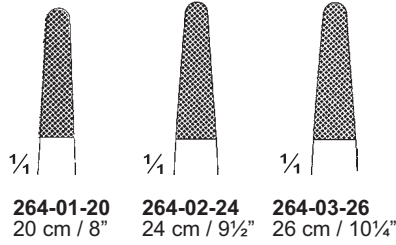

**Wangenstein**  
**264-04-27**  
 27.5 cm / 10¾"

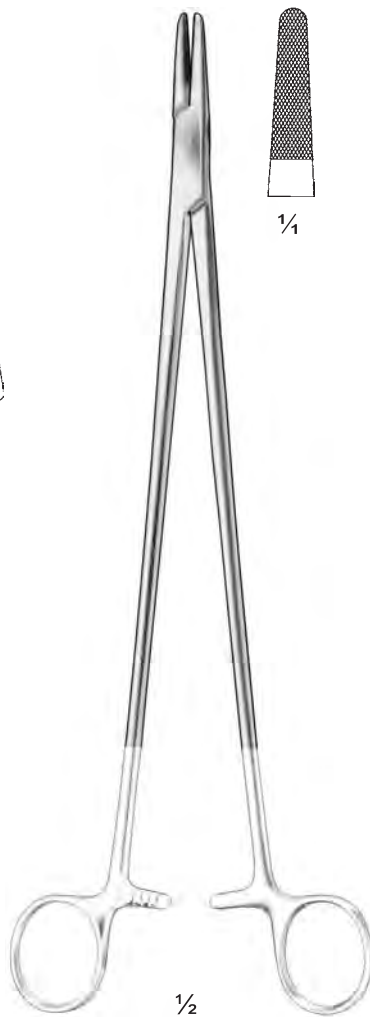

**Masson**  
**264-05-26**  
 26.5 cm / 10½"

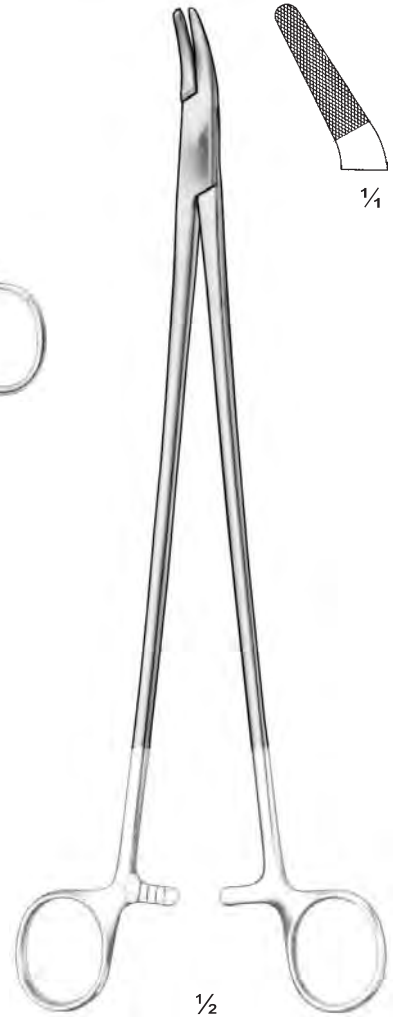

**Finochietto**  
**264-06-26**  
 26.5 cm / 10½"

# Nadelhalter mit Hartmetalleinlagen

## Needle Holder with Tungsten Carbide Inserts

### Porte-aiguilles avec inserts en carbure tungstène



1/2  
Naunton Morgan  
265-01-26  
26 cm / 10 1/4"

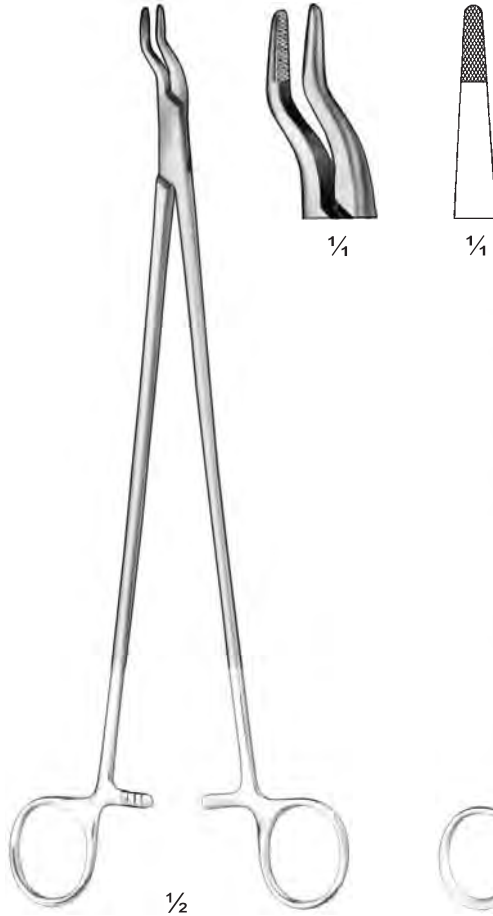

1/2  
265-02-27  
27.5 cm / 10 3/4"

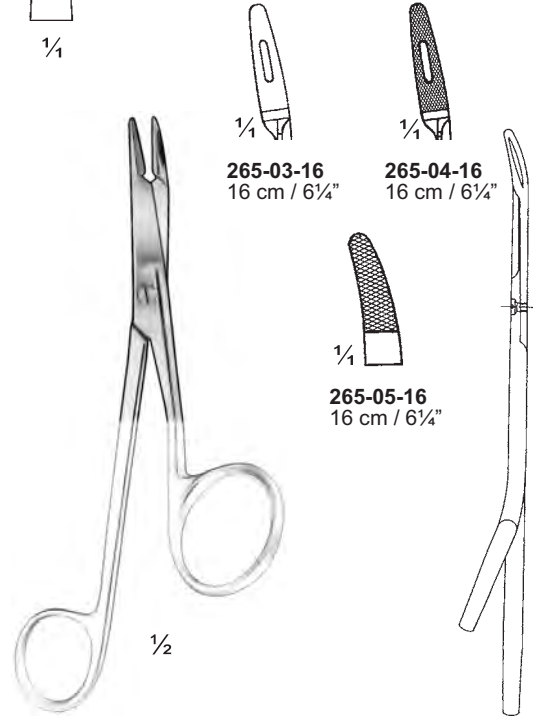

1/2  
Gillies  
265-03-16 To 265-05-16

1/4  
265-03-16  
16 cm / 6 1/4"

1/4  
265-04-16  
16 cm / 6 1/4"

1/4  
265-05-16  
16 cm / 6 1/4"

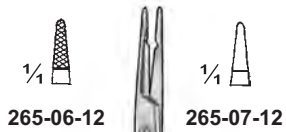

1/4  
265-06-12



1/4  
265-07-12

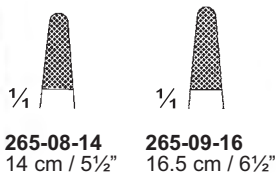

1/4  
265-08-14  
14 cm / 5 1/2"

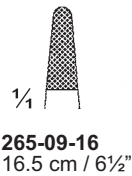

1/4  
265-09-16  
16.5 cm / 6 1/2"

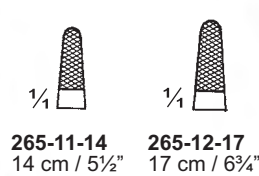

1/4  
265-11-14  
14 cm / 5 1/2"

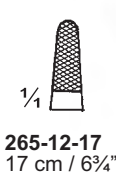

1/4  
265-12-17  
17 cm / 6 3/4"

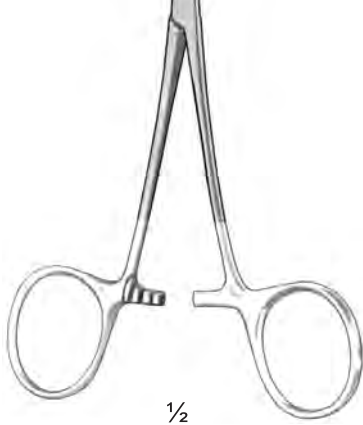

1/2  
Olsen-Hegar  
265-06-12 & 265-07-12  
12 cm / 4 3/4"



1/2  
Olsen-Hegar  
265-08-14 To 265-10-18

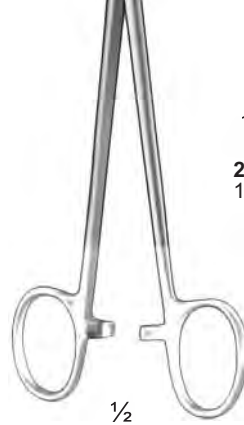

1/2  
Olsen-Hegar  
265-11-14 To 265-13-19

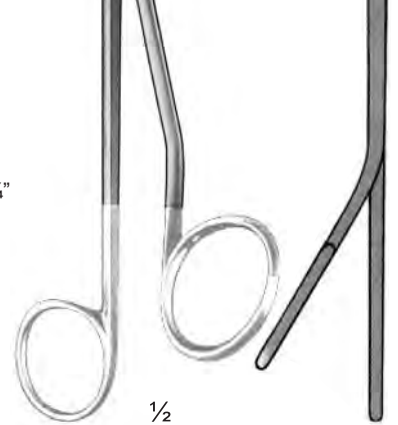

1/2  
Gillies-Slim  
265-14-14  
14.5 cm / 5 3/4"

## Nadelhalter mit Hartmetalleinlagen Needle Holder with Tungsten Carbide Inserts Porte-aiguilles avec inserts en carbure tungstène

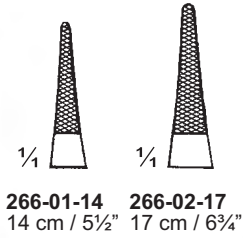

1/2  
Mathieu-Kocher  
266-01-14 To 266-03-20

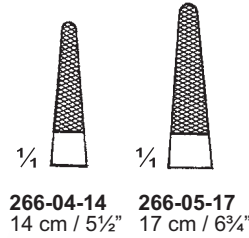
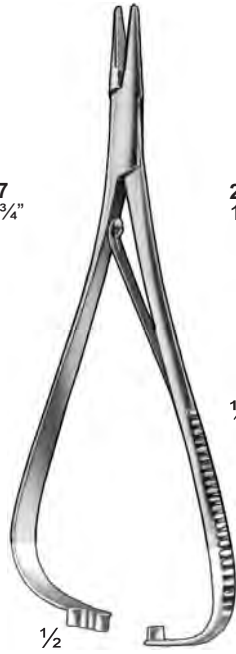

1/2  
Mathieu  
266-04-14 To 266-07-24

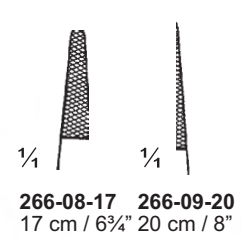
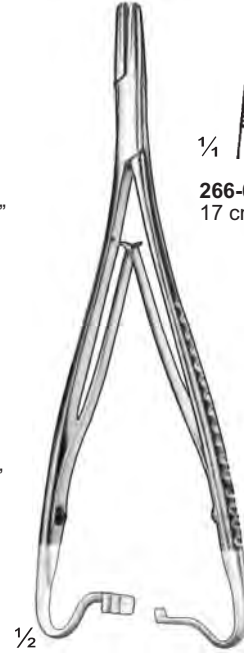

1/2  
Mathieu  
266-08-17 To 266-10-23



1/2  
Lichtenberg  
266-11-20  
20 cm / 8"

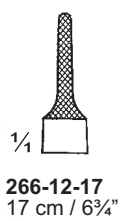
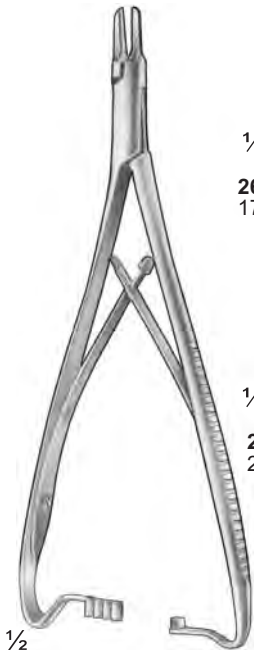

1/2  
Mathieu-Slim  
266-12-17 & 266-13-20

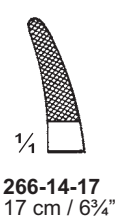

1/2  
Metzenbaum-Mathieu  
266-14-17 & 266-15-20

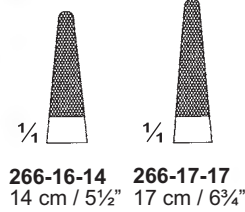

1/2  
Mathieu  
266-16 To 266-18

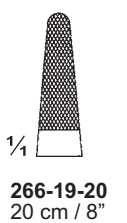
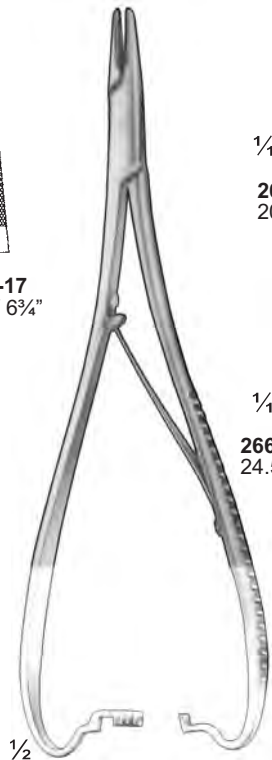

1/2  
Mathieu  
266-19-20 & 266-20-24

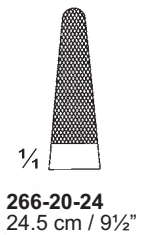



## Nadelhalter mit Hartmetalleinlagen Needle Holder with Tungsten Carbide Inserts Porte-aiguilles avec inserts en carbure tungstène

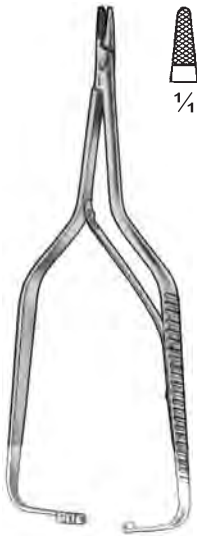

Boynton  
267-01-12  
12 cm / 4¾"



Arruga  
267-02-16  
16 cm / 6¼"



Lichtenberg  
267-03-20 & 267-04-25

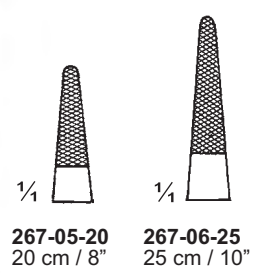
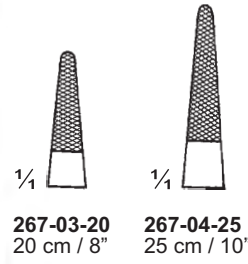

267-05-20 & 267-06-25



Zweifel  
267-07-20 & 267-08-23

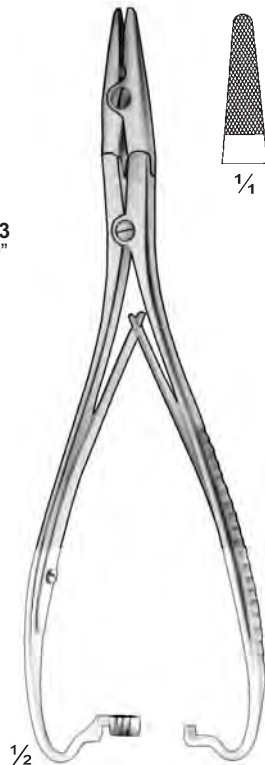
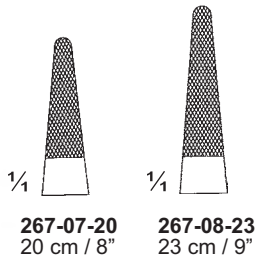

267-09-20  
20 cm / 8"



Hoesel  
267-10-25 & 467-11-26

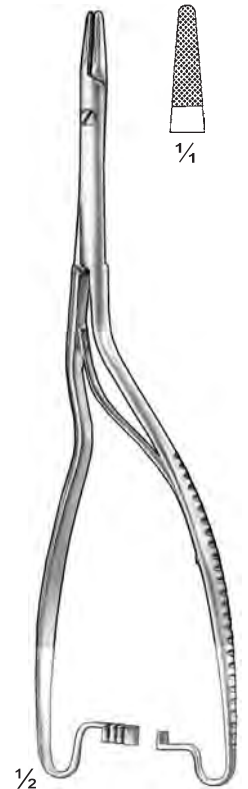

Luethy-Beck  
267-12-20  
20 cm / 8"

## Nadelhalter mit Hartmetalleinlagen Needle Holder with Tungsten Carbide Inserts Porte-aiguilles avec inserts en carbure tungstène



Toennis  
268-01-18  
18 cm / 7"



Langenbeck-Ryder  
268-02-20  
20 cm / 8"



Langenbeck  
268-03-16 To 268-05-20

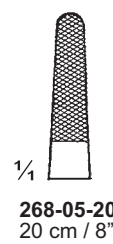
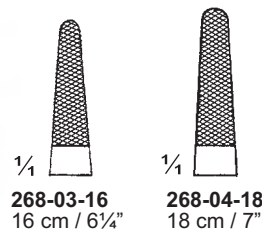

Langenbeck  
268-06-18 To 268-08-23

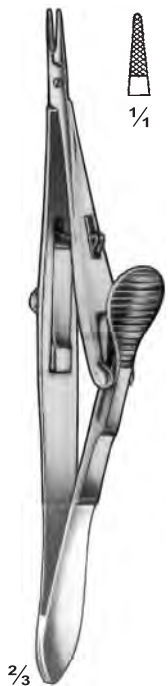
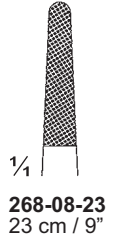
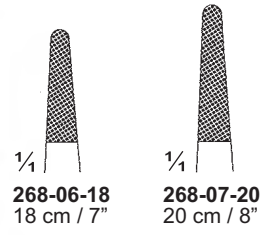

Kalt  
268-09-14  
14 cm / 5 1/2"



Castroviejo  
268-10-13  
13 cm / 5 1/8"



Castroviejo  
268-11-14 To 268-16-21

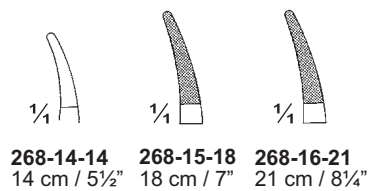
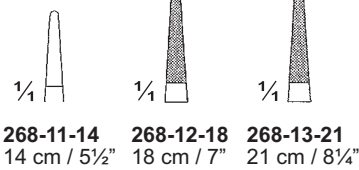

Jacobson  
268-17-18 18.5 cm / 7 1/4"  
268-18-21 21 cm / 8 1/4"



# Mikro-Nadelhalter Micro Needle Holder Micro Porte-aiguilles



Barraquer  
269-01-16  
16 cm / 6 1/4"



Barraquer  
269-02-14  
14 cm / 5 1/2"



Berens  
269-03-14  
14 cm / 5 1/2"



Stevens  
269-04-13 13 cm / 5 1/8"  
269-05-15 15 cm / 6"



Potts-Smith  
269-06-22  
22 cm / 8 3/4"



Castroviejo-Kalt  
269-07-13  
13.5 cm / 5 1/4"



Kalt-Arruga  
269-08-14  
14 cm / 5 1/2"



Kalt  
269-09-14  
14 cm / 5 1/2"





Arruga  
269-10-14  
14 cm / 5 1/2"



Arruga  
269-11-14  
14 cm / 5 1/2"

# Mikro-Nadelhalter Micro Needle Holder Micro Porte-aiguilles



$\frac{1}{4}$    
**270-01-14**  
 $\frac{1}{4}$    
**270-02-14**

$\frac{2}{3}$   
**Barraquer  
270-01-14 & 270-02-14**  
14 cm / 5½"



$\frac{1}{2}$    
**Barraquer  
270-03-11**  
11 cm / 4¼"



$\frac{1}{2}$    
**Barraquer  
270-04-13**  
13 cm / 5⅛"



$\frac{1}{2}$    
**Barraquer  
270-05-14**  
14 cm / 5½"



$\frac{1}{2}$    
**Barraquer  
270-06-13**  
13 cm / 5⅛"

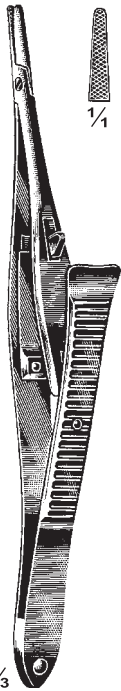

$\frac{2}{3}$    
**Noyes  
270-07-14**  
14 cm / 5½"



$\frac{1}{4}$    
**Barraquer-Troutman  
270-08-10**  
10 cm / 4"



$\frac{1}{4}$    
**Barraquer-Troutman  
270-09-10**  
10 cm / 4"



$\frac{1}{4}$    
**Barraquer-Troutman  
270-10-10**  
10 cm / 4"



$\frac{1}{4}$    
**Barraquer-Troutman  
270-11-10**  
10 cm / 4"

# Mikro-Nadelhalter Micro Needle Holder Micro Porte-aiguilles



Rohrschneider  
271-01-10  
10 cm / 4"



Castroviejo  
271-02-09  
9 cm / 3 1/2"



Castroviejo  
271-03-09  
9 cm / 3 1/2"



Castroviejo  
271-04-09  
9 cm / 3 1/2"



Castroviejo  
271-05-09  
9 cm / 3 1/2"



Castroviejo  
271-06-14 & 271-07-14  
14 cm / 5 1/2"

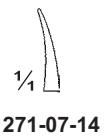
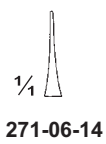

Castroviejo  
271-08-14 & 271-09-14  
14 cm / 5 1/2"

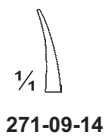
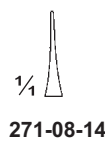

Castroviejo  
271-10-14 & 271-11-14  
14 cm / 5 1/2"

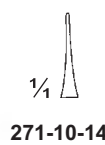

Paton  
271-12-11 To 271-15-11  
11 cm / 4 1/4"

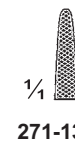

**Mikro-Nadelhalter  
Micro Needle Holder  
Micro Porte-aiguilles**



$\frac{1}{4}$   
**272-01-15**  
 $\frac{1}{4}$   
**272-02-15**

Reill  
**272-01-15 & 272-02-15**  
15 cm / 6"



$\frac{1}{4}$   
**272-03-15**  
 $\frac{1}{4}$   
**272-04-15**

**272-03-15 & 272-04-15**  
15 cm / 6"



$\frac{1}{4}$   
**272-05-18**  
 $\frac{1}{4}$   
**272-06-18**

**272-05-18 & 272-06-18**  
18 cm / 7"



$\frac{1}{4}$   
**272-07-18**  
 $\frac{1}{4}$   
**272-08-18**

**272-07-18 & 272-08-18**  
18 cm / 7"



$\frac{1}{4}$

Müller  
**272-09-14**  
14.5 cm / 5 $\frac{3}{4}$ "



$\frac{1}{4}$

**272-10-23**  
23 cm / 9"



$\frac{1}{4}$   
**272-11-15**  
 $\frac{1}{4}$   
**272-12-15**

Brock  
**272-11-15 & 272-12-15**  
15 cm / 6"



$\frac{1}{4}$   
**272-13-18**  
 $\frac{1}{4}$   
**272-14-18**

Brock  
**272-13-18 & 272-14-18**  
18 cm / 7"



$\frac{1}{4}$   
**272-15-16**  
 $\frac{1}{4}$   
**272-16-16**

Arruga  
**272-15-16 & 272-16-16**  
16 cm / 6 $\frac{1}{4}$ "

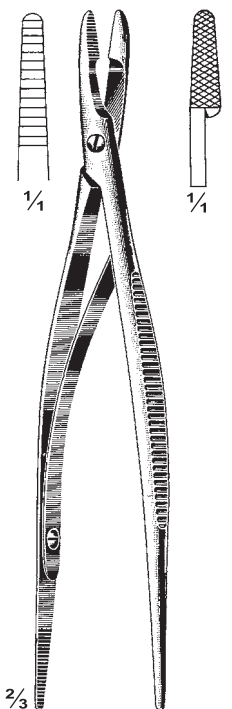

$\frac{1}{4}$

$\frac{1}{4}$

$\frac{2}{3}$

Castroviejo  
**272-17-14**  
14 cm / 5 $\frac{1}{2}$ "

# Mikro-Nadelhalter Micro Needle Holder Micro Porte-aiguilles

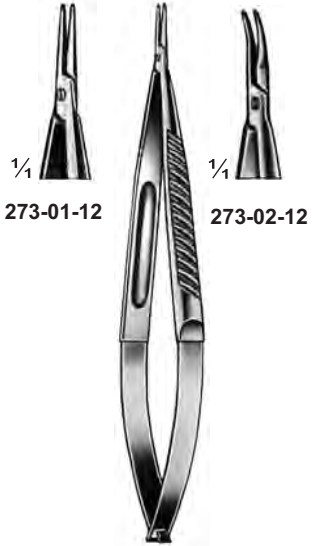

1/4  
273-01-12      1/4  
273-02-12

273-01-12 & 273-02-12  
12 cm / 4 3/4"

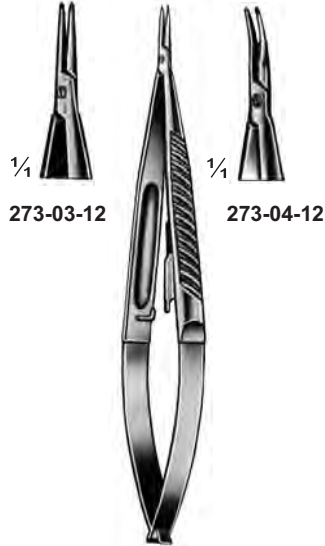

1/4  
273-03-12      1/4  
273-04-12

273-03-12 & 273-04-12  
12 cm / 4 3/4"



1/4  
1/4

273-05-12  
12 cm / 4 3/4"

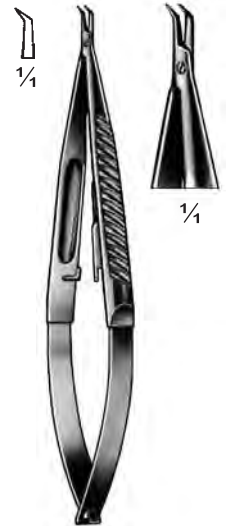

1/4  
1/4

273-06-12  
12 cm / 4 3/4"

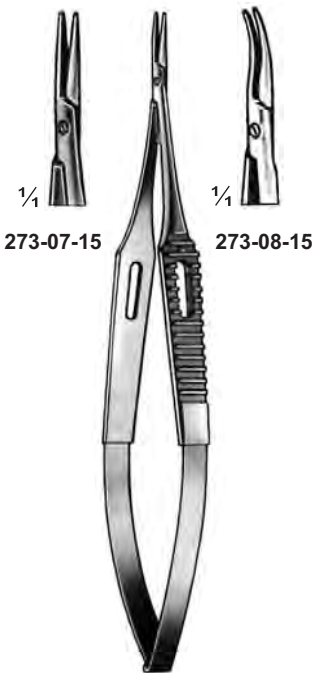

1/4  
273-07-15      1/4  
273-08-15

273-07-15 & 273-08-15  
15 cm / 6"

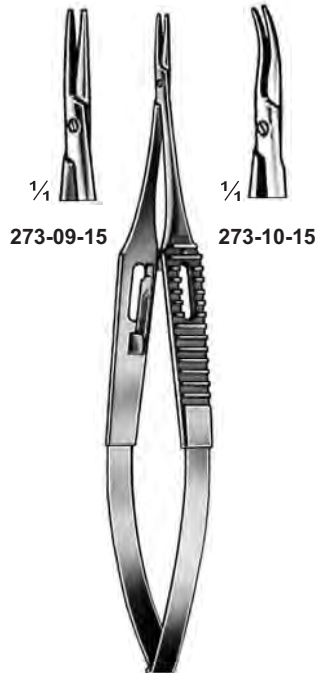

1/4  
273-09-15      1/4  
273-10-15

273-09-15 & 273-10-15  
15 cm / 6"

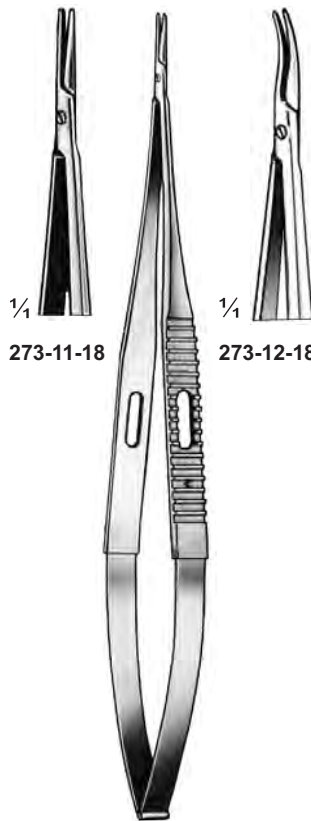

1/4  
273-11-18      1/4  
273-12-18

273-11-18 & 273-12-18  
18 cm / 7"

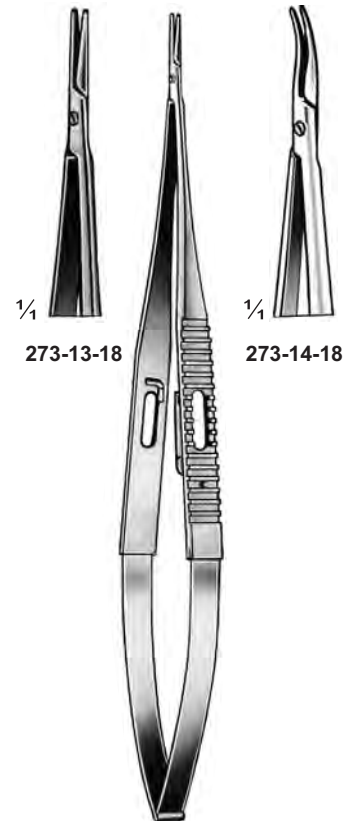

1/4  
273-13-18      1/4  
273-14-18

273-13-18 & 273-14-18  
18 cm / 7"



# Mikro-Nadelhalter Micro Needle Holder Micro Porte-aiguilles

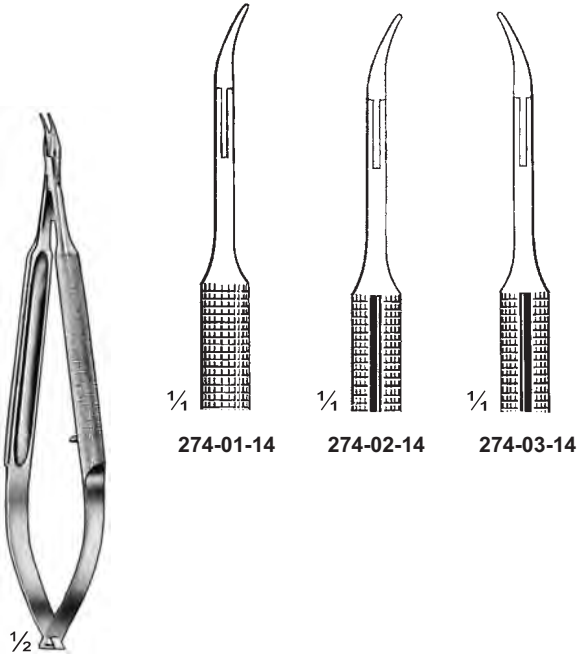

274-01-14    274-02-14    274-03-14

Gomel  
274-01-14 To 274-03-14  
14 cm / 5½"

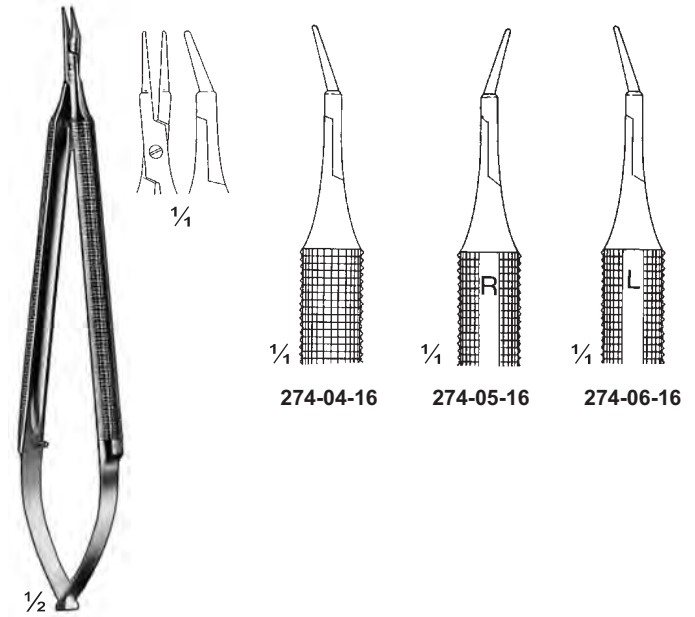

274-04-16    274-05-16    274-06-16

Gomel  
274-04-16 To 274-06-16  
16 cm / 6¼"



274-07-18  
With catch

274-08-18  
Without catch

Jacobson  
274-07-18 & 274-08-18  
18.5 cm / 7¼"



Castroviejo  
274-09-13  
13 cm / 5⅛"



Castroviejo-Barraquer  
274-10-12  
12 cm / 4¾"



Castroviejo  
274-11-12  
12 cm / 4¾"



**Mikro-Nadelhalter  
Micro Needle Holder  
Micro Porte-aiguilles**

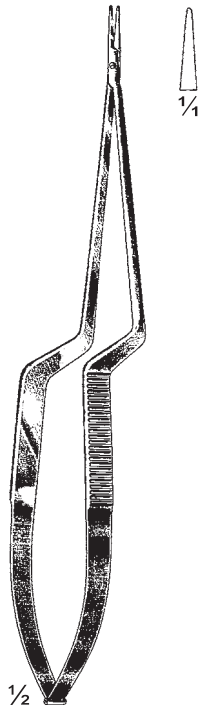

Jacobson  
**275-01-18**  
18.5 cm / 7 1/4"

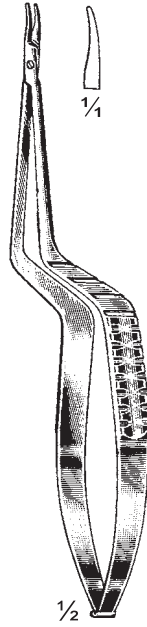

**275-02-16**  
16 cm / 6 1/4"



Yasargil  
**275-03-20 & 275-04-20**  
20 cm / 8"

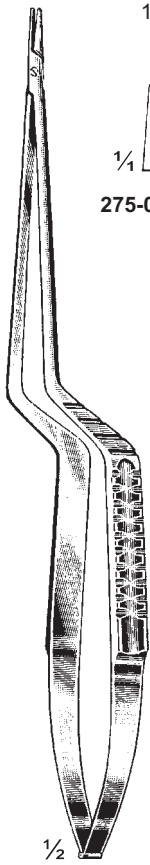
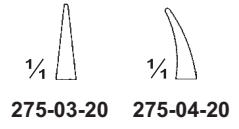

**275-05-22**   **275-06-22**

Yasargil  
**275-05-22 & 275-06-22**  
22.5 cm / 8 3/4"



**275-07-22**   **275-08-22**

Yasargil  
**275-07-22 & 275-08-22**  
22.5 cm / 8 3/4"



Yasargil  
**275-09-24**  
24.5 cm / 9 3/4"

# Reverdin Nadeln Reverdin Needles Aguilles de Reverdin



1/2

Reverdin  
276-01-14 To 276-04-14  
14 cm / 5 1/2"



1/4

276-01-14



1/4

276-02-14



1/4

276-03-14



1/4

276-04-14



1/4

Reverdin  
276-05-19 To 276-08-19  
19.5 cm / 7 3/4"



1/4

276-05-19



1/4

276-06-19



1/4

276-07-19



1/4

276-08-19



1/4

Reverdin  
276-09-22 To 276-12-22  
22 cm / 8 3/4"

1/2



1/4

276-09-22



1/4

276-10-22



1/4

276-11-22



1/4

276-12-22

Reverdin Nadeln  
Reverdin Needles  
Aguilles de Reverdin

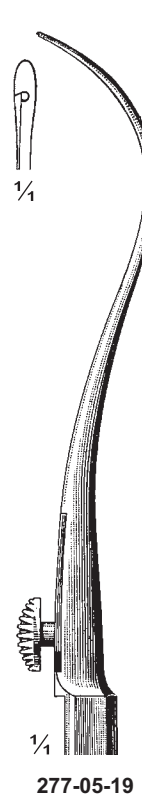
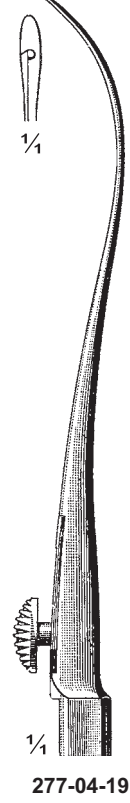
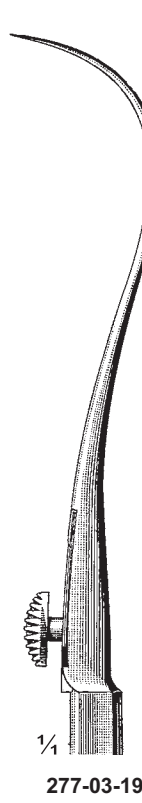
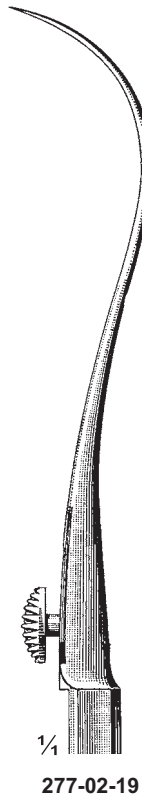
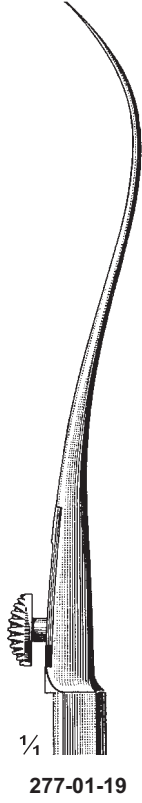

Albaran  
277-01-19 To 277-06-19  
19.5 cm / 7<sup>3</sup>/<sub>4</sub>"

**Reverdin Nadeln  
Reverdin Needles  
Aguilles de Reverdin**



Reverdin  
278-01-25  
25 cm / 10"

Tierny  
278-02-25  
25 cm / 10"

Tierny  
278-03-27  
27 cm / 10½"

Redon  
278-04-25  
25 cm / 10"

Redon  
278-05-27  
27 cm / 10½"