

**Zungenzangen
Tongue Holding Forceps
Pincers tire-langue**



$\frac{1}{4}$
578-01-17
578-07-17
578-13-17
17 cm / 6 $\frac{3}{4}$ "



$\frac{1}{4}$
578-02-17
578-08-17
578-14-17
17 cm / 6 $\frac{3}{4}$ "



$\frac{1}{4}$
578-03-16
578-09-16
578-15-16
16 cm / 6 $\frac{1}{4}$ "



$\frac{1}{2}$

Collin
578-01-17 To 578-06-19



$\frac{1}{4}$
578-04-17
578-10-17
578-16-17
17 cm / 6 $\frac{3}{4}$ "



$\frac{1}{2}$

Collin
578-07-17 To 578-12-19



$\frac{1}{4}$
578-05-17
578-11-17
578-17-17
17 cm / 6 $\frac{3}{4}$ "

578-06-19
578-12-19
578-18-19
19 cm / 7 $\frac{1}{2}$ "



$\frac{1}{2}$

Collin
578-14-17 To 578-18-19

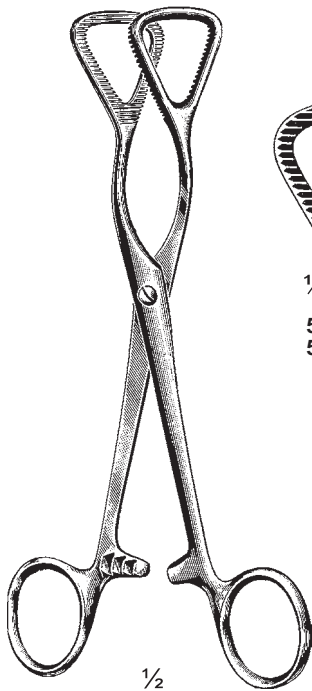

$\frac{1}{2}$

Guy
578-19-19 & 578-20-19
19 cm / 7 $\frac{1}{2}$ "



$\frac{1}{4}$
578-19-19
578-21-19



$\frac{1}{4}$
578-20-19
578-22-19



$\frac{1}{2}$

Guy
578-21-19 & 578-22-19
19 cm / 7 $\frac{1}{2}$ "

Zungenzangen
Tongue Holding Forceps
Pinces tire-langue

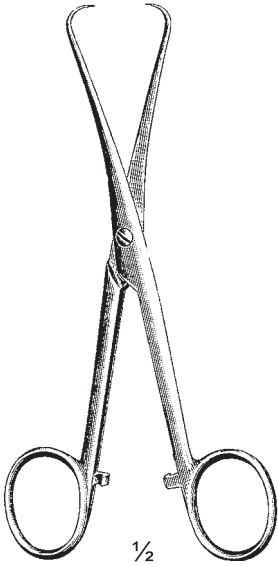

Loebker
579-01-15
 15 cm / 6"



Stille
579-02-16
 16 cm / 6 1/4"



Young
579-03-16
 16.5 cm / 6 1/2"

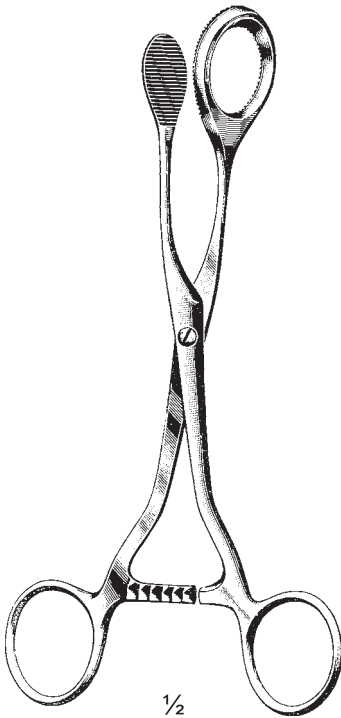

Mathieu
579-04-19
 19 cm / 7 1/2"

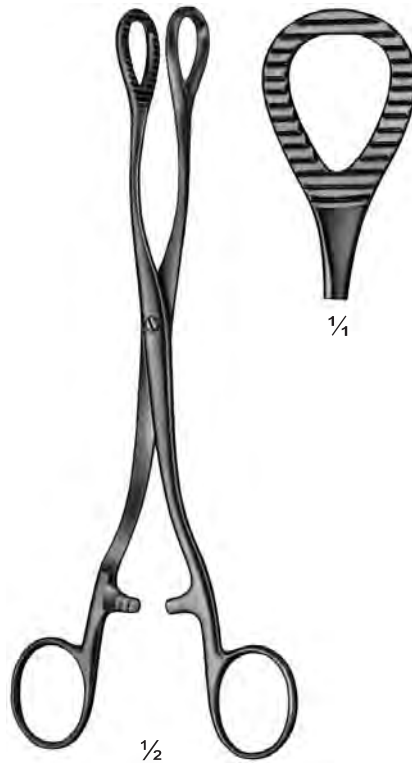

Heywood-Smith
579-05-20
 20 cm / 8"

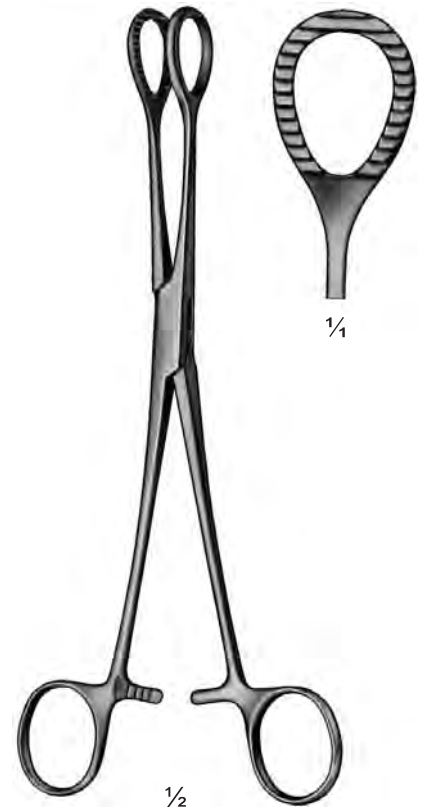

Heywood-Smith Modif.
579-06-21
 21.5 cm / 8 1/2"



Fig. 000
6 mm Ø



Fig. 00
8 mm Ø



Fig. 0
10 mm Ø

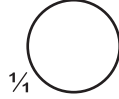

Fig. 1
12 mm Ø

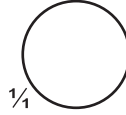

Fig. 2
14 mm Ø

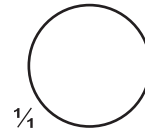

Fig. 3
16 mm Ø

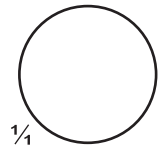

Fig. 4
18 mm Ø

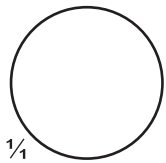

Fig. 5
20 mm Ø

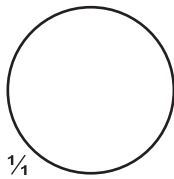

Fig. 6
22 mm Ø

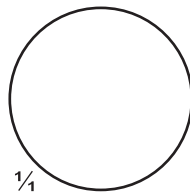

Fig. 7
24 mm Ø

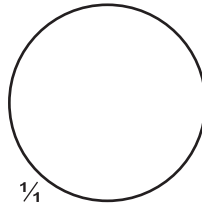

Fig. 8
26 mm Ø

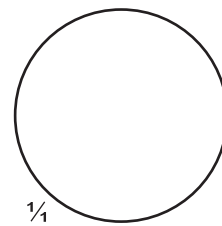

Fig. 9
28 mm Ø

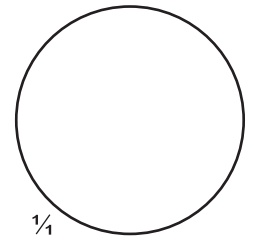
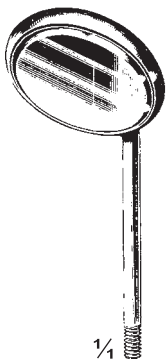
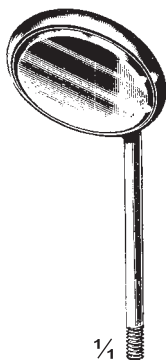

Fig. 10
30 mm Ø



1/4



1/4



1/2



1/2



1/2



1/2

Plain		Magnifying	
580-01-06	Fig. 00	6 mm Ø	580-14-06
580-02-08	Fig. 0	8 mm Ø	580-15-08
580-03-10	Fig. 1	10 mm Ø	580-16-10
580-04-12	Fig. 2	12 mm Ø	580-17-12
580-05-14	Fig. 3	14 mm Ø	580-18-14
580-06-16	Fig. 4	16 mm Ø	580-19-16
580-07-18	Fig. 5	18 mm Ø	580-20-18
580-08-20	Fig. 6	20 mm Ø	580-21-20
580-09-22	Fig. 7	22 mm Ø	580-22-22
580-10-24	Fig. 8	24 mm Ø	580-23-24
580-11-26	Fig. 9	26 mm Ø	580-24-26
580-12-28	Fig. 10	28 mm Ø	580-25-28
580-13-30	Fig. 11	30 mm Ø	580-26-30

Plain		Magnifying	
580-27-06	Fig. 00	6 mm Ø	580-40-06
580-28-08	Fig. 0	8 mm Ø	580-41-08
580-29-10	Fig. 1	10 mm Ø	580-42-10
580-30-12	Fig. 2	12 mm Ø	580-43-12
580-31-14	Fig. 3	14 mm Ø	580-44-14
580-32-16	Fig. 4	16 mm Ø	580-45-16
580-33-18	Fig. 5	18 mm Ø	580-46-18
580-34-20	Fig. 6	20 mm Ø	580-47-20
580-35-22	Fig. 7	22 mm Ø	580-48-22
580-36-24	Fig. 8	24 mm Ø	580-49-24
580-37-26	Fig. 9	26 mm Ø	580-50-26
580-38-28	Fig. 10	28 mm Ø	580-51-28
580-39-30	Fig. 11	30 mm Ø	580-52-30
		12 cm / 4 3/4"	12 cm / 4 3/4"

580-53-07
7 cm / 2 3/4"

580-54-11
11 cm / 4 1/4"

**Kehlkopfspiegel
Laryngeal Mirrors
Miroirs Laryngiens**

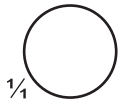

581-06-12
Fig. 2
12 mm Ø

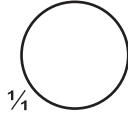

581-07-14
Fig. 3
14 mm Ø

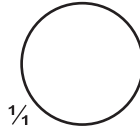

581-08-16
Fig. 4
16 mm Ø

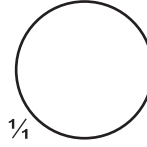

581-09-18
Fig. 5
18 mm Ø



Michel
581-06-12 To 581-09-18
25 cm / 10"



581-01-11
11 cm / 4 1/4"



581-02-10
10.5 cm / 4 1/8"



581-03-12
12 cm / 4 3/4"



581-04-13
13 cm / 5 1/8"

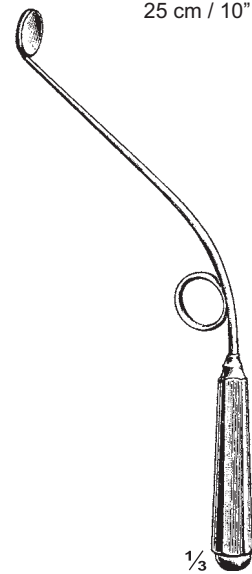

Baxt
581-05-24
24 cm / 9 1/2"

Laryngeal Zange
Laryngeal Forceps
Forceps Larynges



**Laryngeal Zange
Laryngeal Forceps
Forceps Larynges**

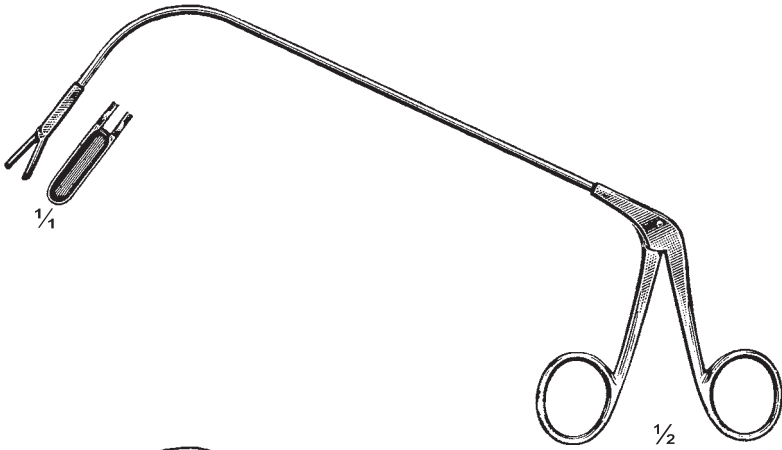

Fraenkel
583-01-19
19 cm / 7½"

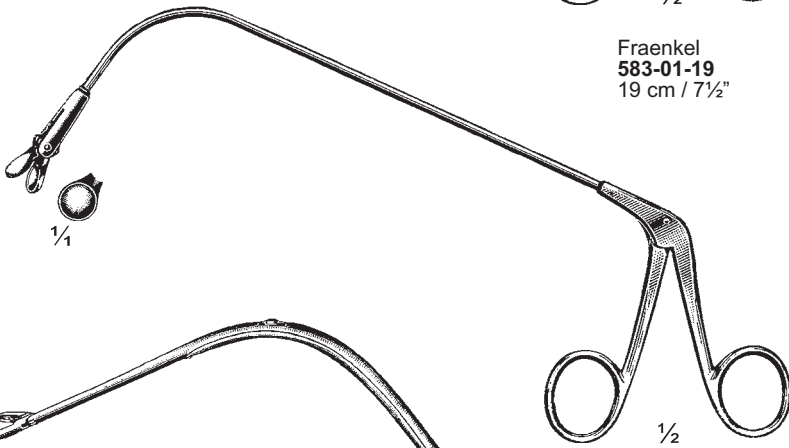

Lange
583-02-19
19 cm / 7½"

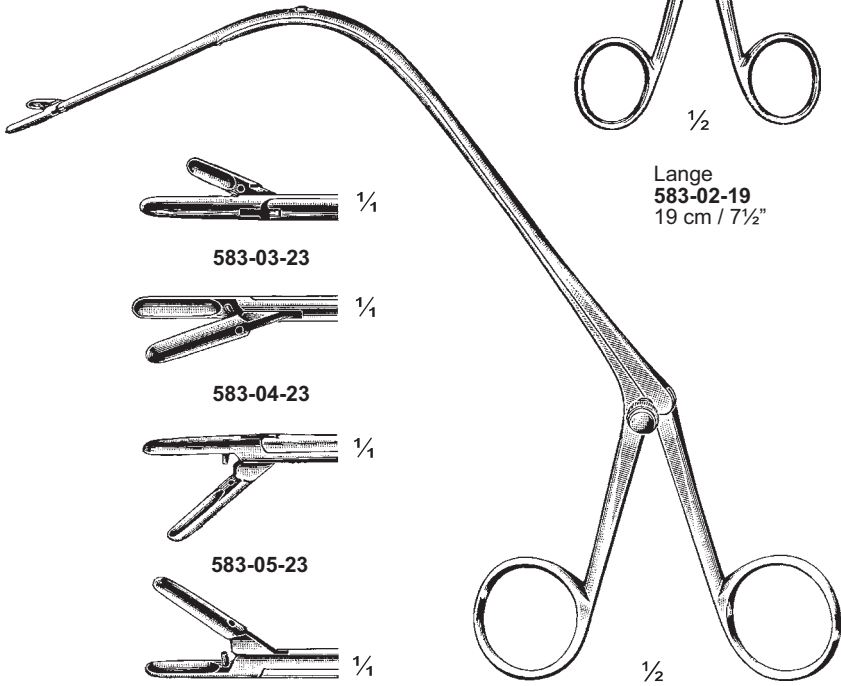

Jurasz
583-03-23 To 583-06-23
23 cm / 9"



583-03-23



583-04-23



583-05-23



583-06-23

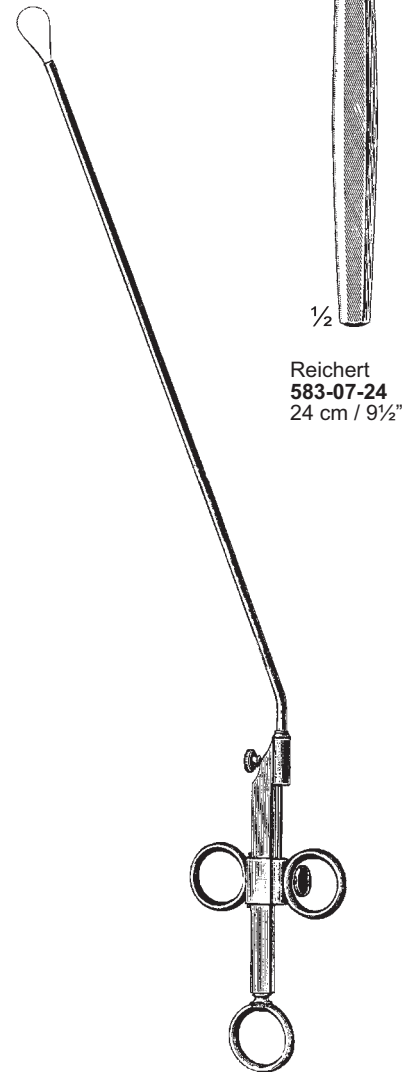

Reichert
583-07-24
24 cm / 9½"

583-08-24
24 cm / 9½"

Mobilisierhaken Temporomandibular Instruments Crochet de mobilisation

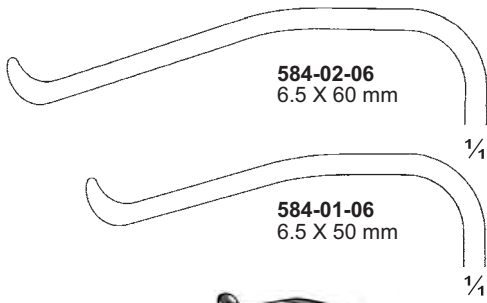

584-02-06
6.5 X 60 mm

584-01-06
6.5 X 50 mm



Dunn-Dautrey
584-01-06 & 584-02-06
15 cm / 6"

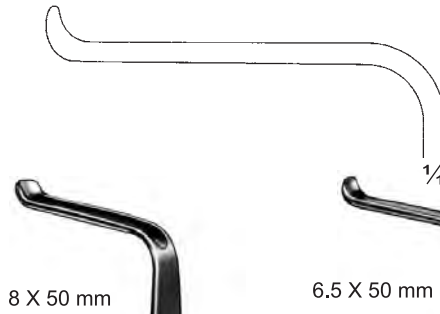

8 X 50 mm

6.5 X 50 mm



Dunn-Dautrey
584-03-15
15 cm / 6"



Dunn-Dautrey
584-04-15
15 cm / 6"



Dunn-Dautrey
584-05-13
13.5 cm / 5 1/4"

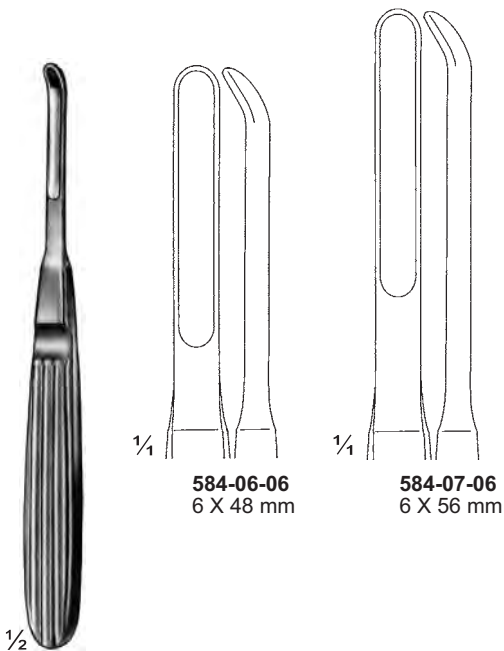

584-06-06
6 X 48 mm

584-07-06
6 X 56 mm

Dunn-Dautrey
584-06-06 & 484-07-06
15 cm / 6"

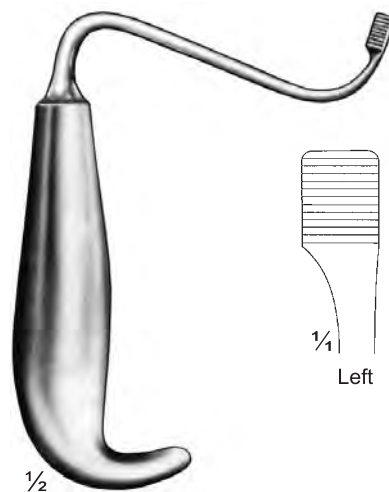

Tessier
584-08-00



Left

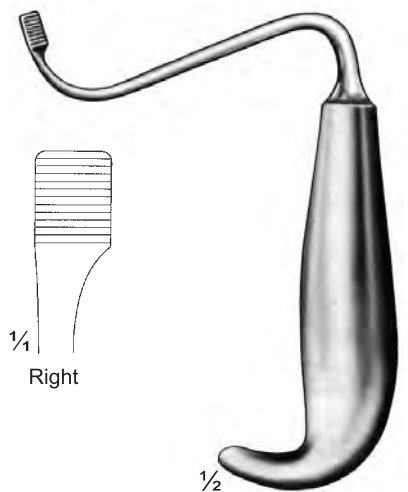

Tessier
584-09-00



Right

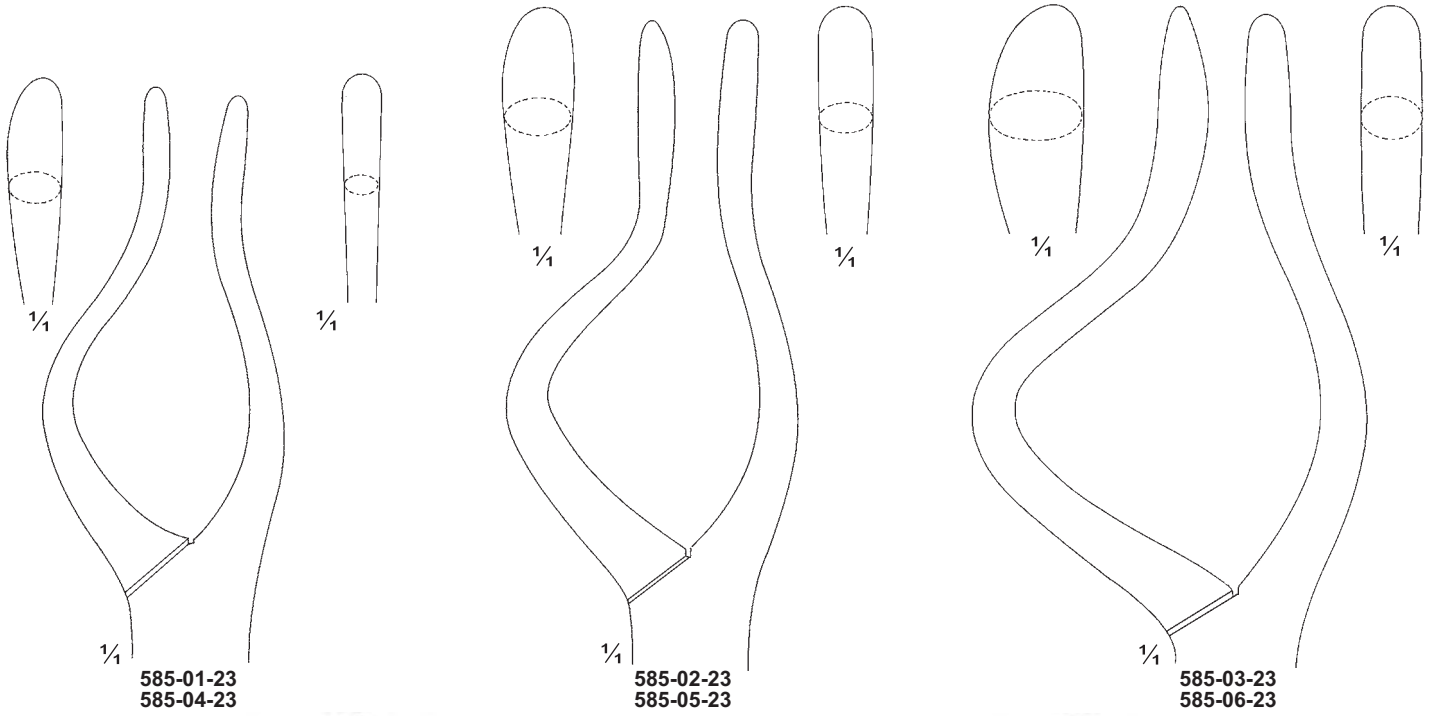

Rowe
585-01-23 To 585-03-23
23 cm / 9"
Left



Rowe
585-04-23 To 585-06-23
23 cm / 9"
Right

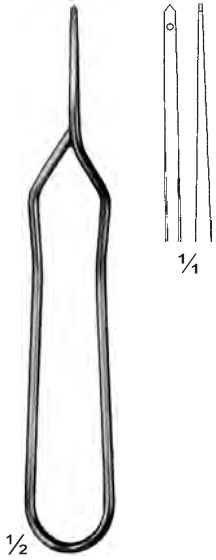

Kelsey-Fry
586-01-15
15 cm / 6"

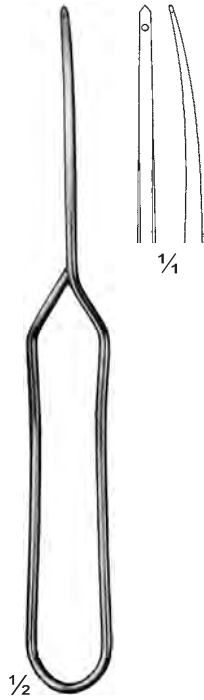

Kelsey-Fry
586-02-18
18 cm / 7"



Obwegesser
586-03-18 18 cm / 7"
586-04-28 28 cm / 11"



Obwegesser
586-05-13
13 cm / 5 "



Obwegesser
586-06-23
23 cm / 9"

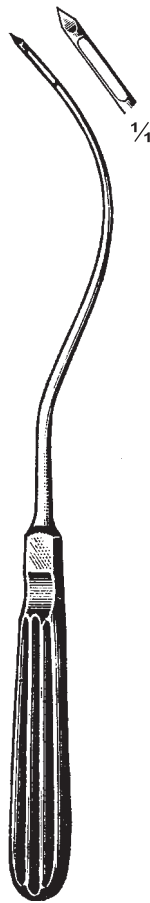

Sanders-Brown
586-07-29
29 cm / 11½"

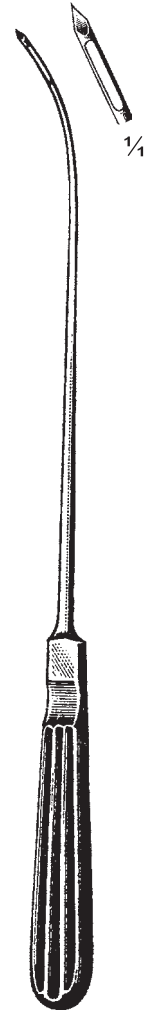

Sanders-Brown
586-08-30
30 cm / 12"

Tonsillenmesser
Tonsil Knife
Bistouri éténucléateur pour

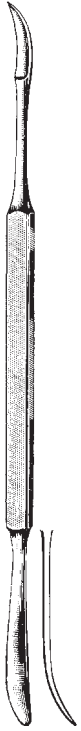

Lynch
587-01-20
20 cm / 8"



Lothrop
587-02-20
20 cm / 8"

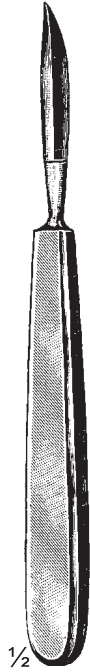

$\frac{1}{2}$
587-03-18
18 cm / 7"



587-04-18
18 cm / 7"



$\frac{1}{4}$

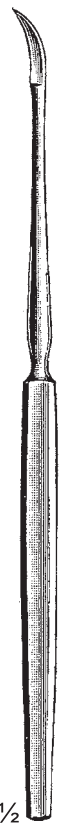

$\frac{1}{2}$
Abraham
587-05-21
21 cm / 8 $\frac{1}{4}$ "



$\frac{1}{4}$

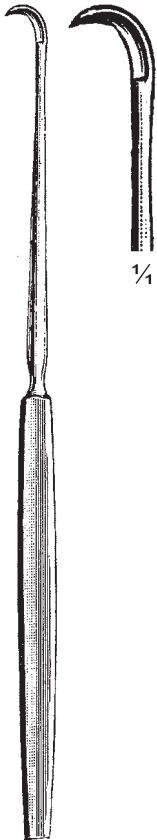

Bruenings
587-06-23
23 cm / 9"

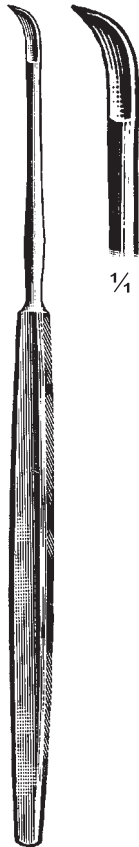

Canfield
587-07-21
21 cm / 8 $\frac{1}{4}$ "



$\frac{1}{2}$
Tyding
587-08-21
21 cm / 8 $\frac{1}{4}$ "



$\frac{1}{2}$
Robb
587-09-22
22 cm / 8 $\frac{3}{4}$ "



$\frac{1}{4}$



$\frac{1}{4}$

**Tonsillennesser
Tonsil Knife
Bistouri étenucléateur pour**

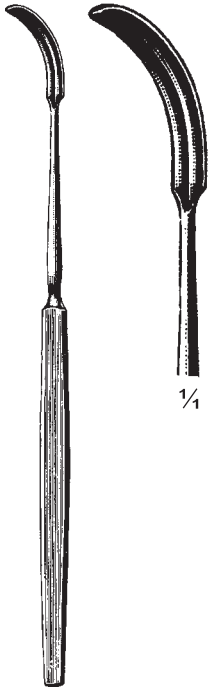

Robertson
588-01-21
21.5 cm / 8½"

¼

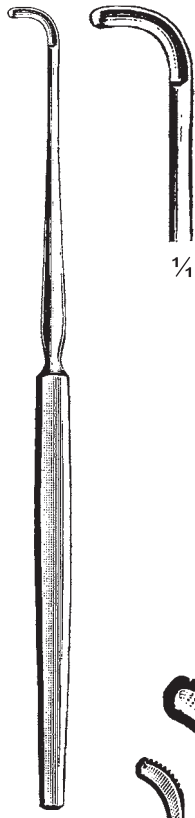

Abraham
588-02-20
20 cm / 8"

¼

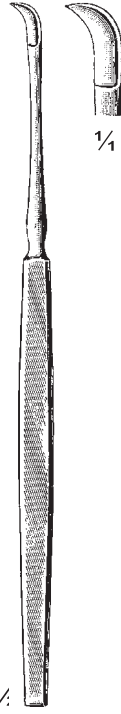

Brophy
588-03-19
19 cm / 7½"

¼

½



Freer
588-04-21
21 cm / 8¼"

½



Freer
588-05-21
21 cm / 8¼"

½



Fischer
588-07-23
23 cm / 9"

¼



Day
588-06-21
21.5 cm / 8½"

½



Colver
588-08-23
23 cm / 9"

½



Douglas
588-09-21
21 cm / 8¼"

½

¼

Tonsillenmesser
Tonsil Knife
Bistouri éténucléateur pour

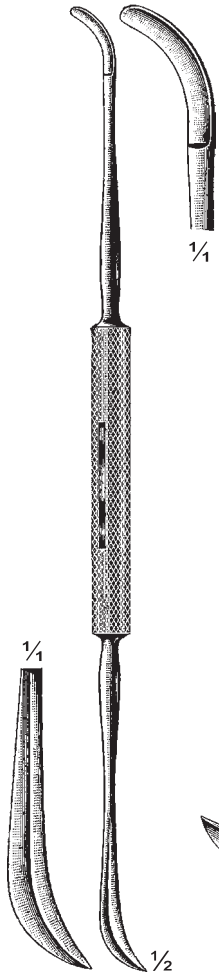

Harris
589-01-26
26 cm / 10 $\frac{1}{4}$ "

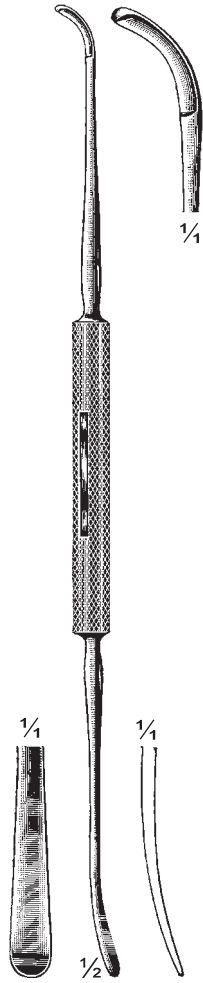

Milette
589-02-26
26 cm / 10 $\frac{1}{4}$ "

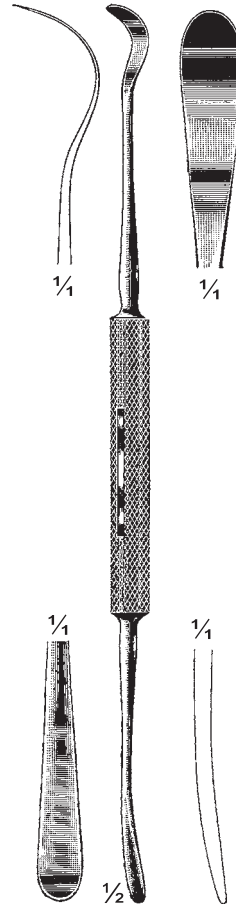

Carpenter
589-03-24
24 cm / 9 $\frac{1}{2}$ "

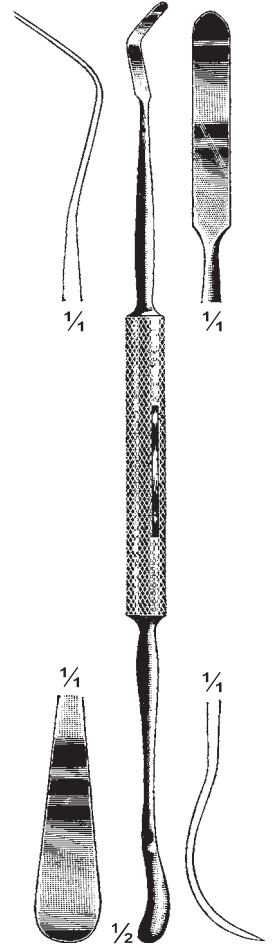

Carpenter
589-04-25
25 cm / 10"

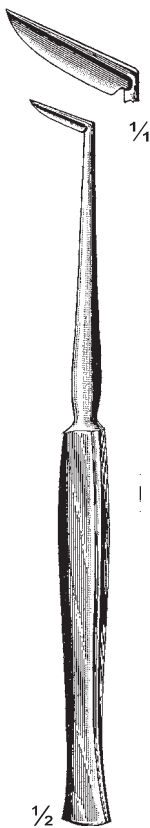

Whitehead
589-05-19
19 cm / 7 $\frac{1}{2}$ "

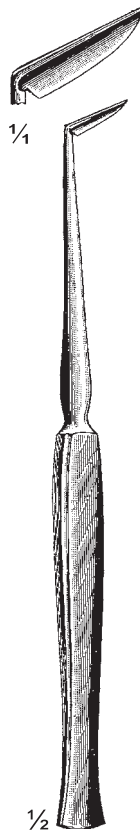

Whitehead
589-06-19
19 cm / 7 $\frac{1}{2}$ "



Dean
589-07-19 & 589-08-19
19 cm / 7 $\frac{1}{2}$ "

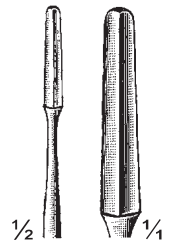

589-07-19

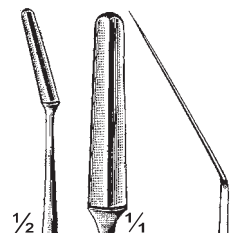

589-08-19

**Tonsillenelevator/ Retraktor, Tonsillenelevatorien
Tonsil Dissector/Retractor, Tonsil Elevators
Dissecteur/Rétracteur pour amygdales, Élévateurs pour amygdales**

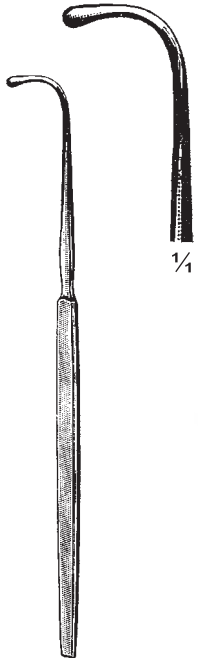

Colver
590-01-19
19 cm / 7½"

¼



590-02-21 To 590-04-21
21.5 cm / 8½"



½
Kyle
590-02-21



½
Boettcher
590-03-21



½
Boettcher
590-04-21

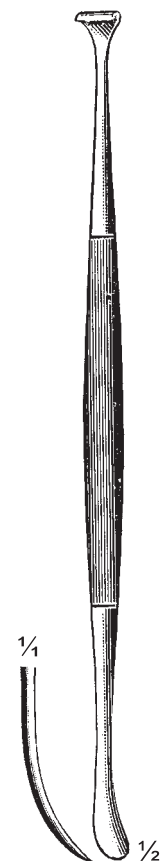

Hurd
590-05-22 & 590-06-22
22 cm / 8¾"

¼

½

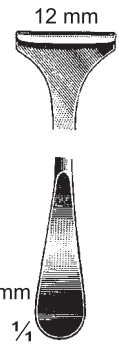

6 mm
¼
590-05-22

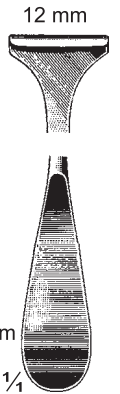

10 mm
¼
590-06-22



Roeder
590-07-26
26.5 cm / 10½"

½

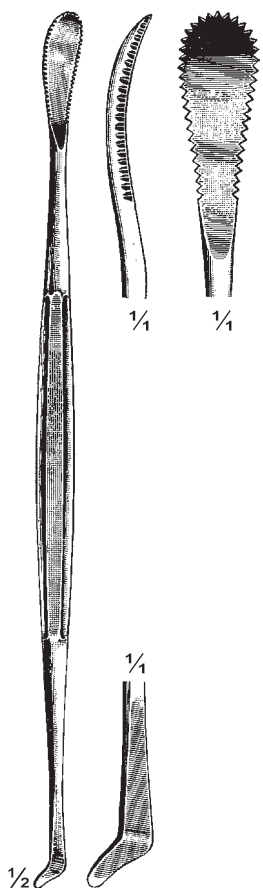

Henke
590-08-23
23 cm / 9"

½

¼

¼

¼

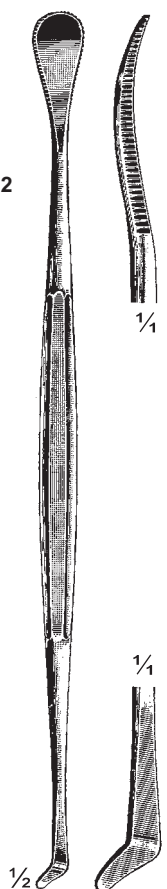

Henke
590-09-23
23 cm / 9"

½

¼

¼

¼

**Tonsillenelevator/ Retraktor, Tonsillenelevatorien
Tonsil Dissector/Retractor, Tonsil Elevators
Dissecteur/Rétracteur pour amygdales, Elévateurs pour amygdales**

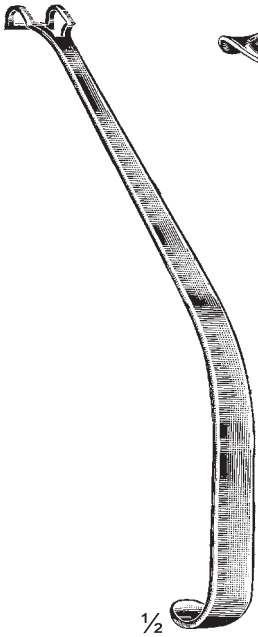

1/2
Robb-Lewis
591-01-16
16 cm / 6 1/4"

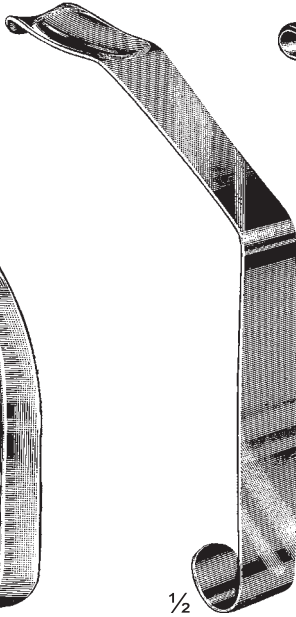

1/2
Love
591-02-18 18 mm
591-03-20 20 mm
591-04-22 22 mm
15 cm / 6"

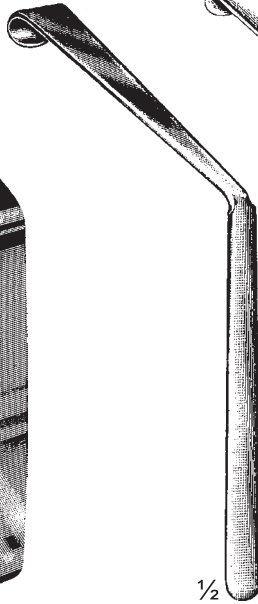

1/2
Goodyear
591-05-16
16 cm / 6 1/4"

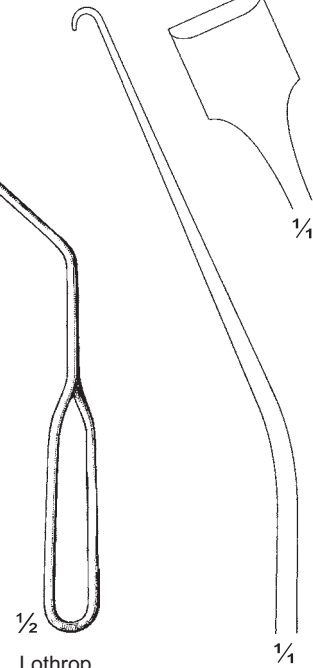

1/2
Lothrop
591-06-17
17 cm / 6 3/4"



1/2
Nager
591-07-24
24 cm / 9 1/2"

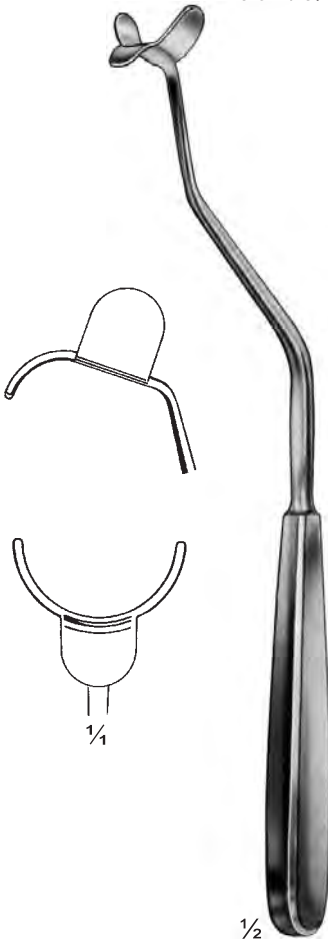

1/2
Hofer
591-08-24
24 cm / 9 1/2"



1/2
Wieder
591-09-21
21.5 cm / 8 1/2"

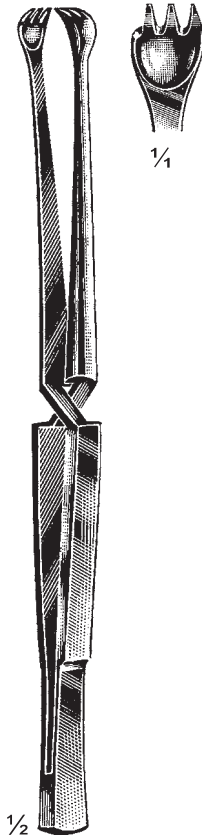

1/2
Marschik
591-10-22
22 cm / 8 3/4"



1/2
Lewis
591-11-19 & 591-12-19
19.5 cm / 7 3/4"



1/1
591-11-19



1/1
591-12-19

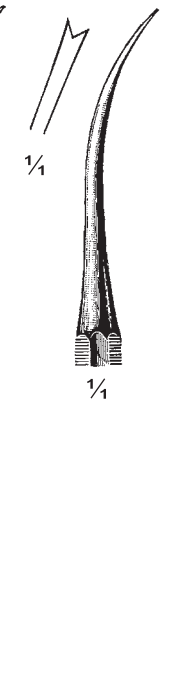

1/2
Luniatschek
591-13-19
19 cm / 7 1/2"

**Tonsillenelevator/ Retraktor, Tonsillenelevatorien
Tonsil Dissector/Retractor, Tonsil Elevators
Dissecteur/Rétracteur pour amygdales, Elévateurs pour amygdales**

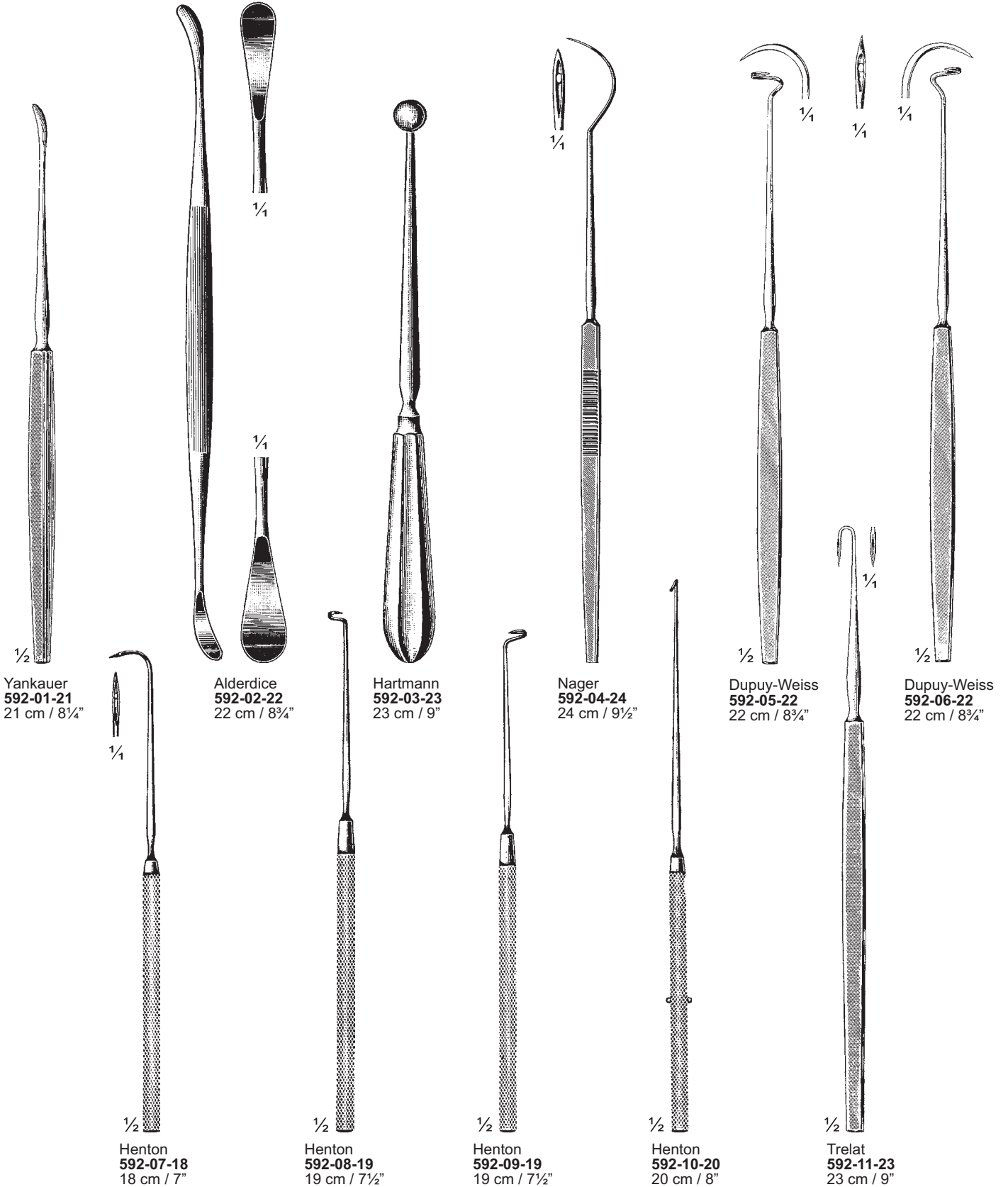

Tonsillenkanüle Tonsil Needles Aiguille pour amygdales

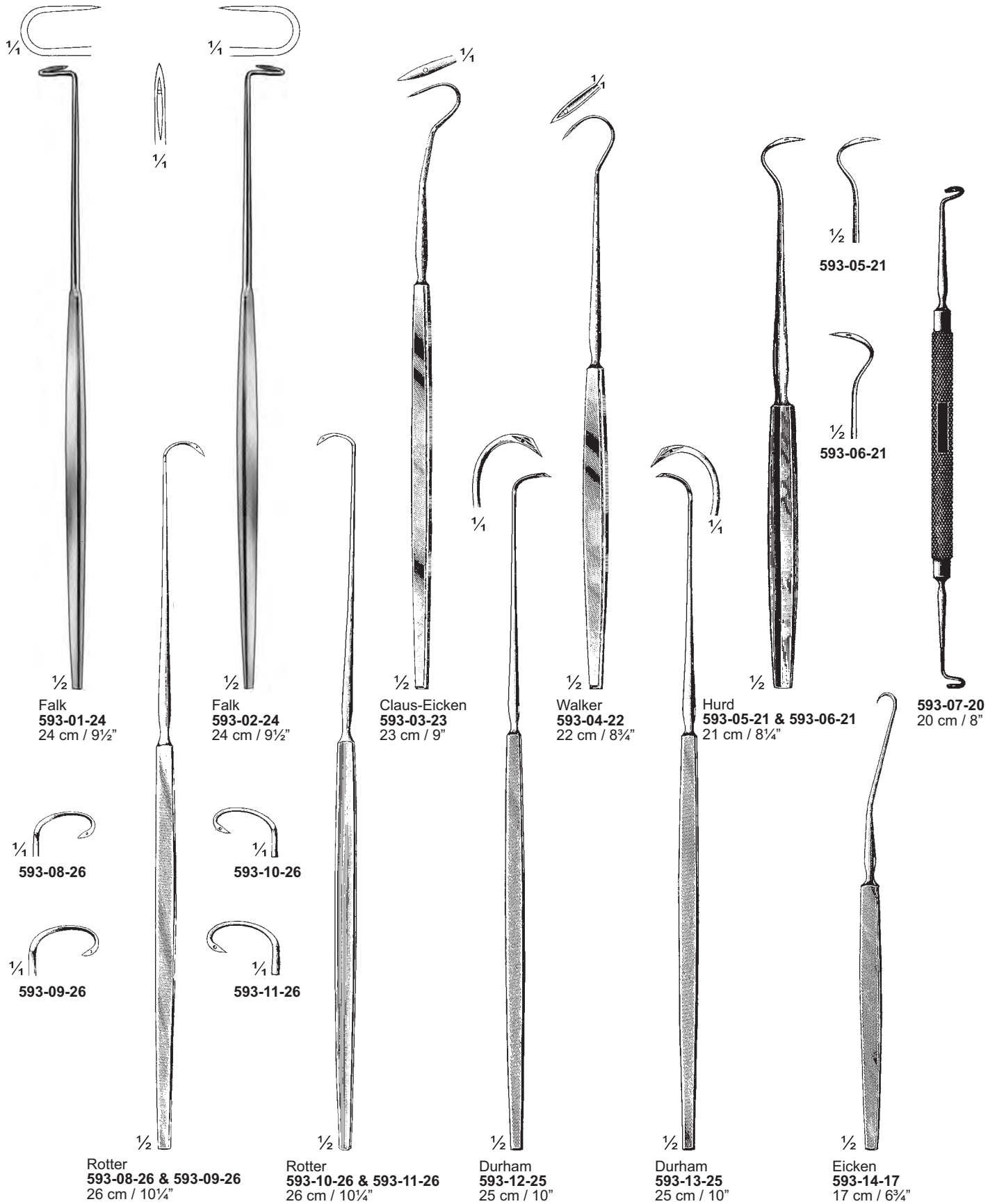

**Tonsillenklemmen
Tonsil Forceps
Pincès pour amygdales**

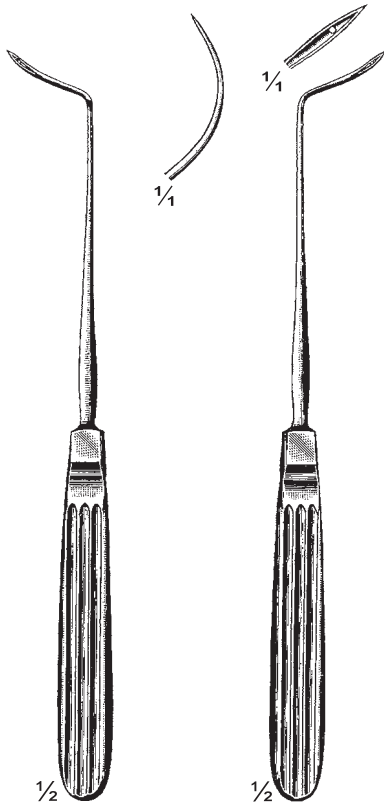

$\frac{1}{2}$
Alexander
594-01-20
20 cm / 8"

$\frac{1}{2}$
Alexander
594-02-20
20 cm / 8"

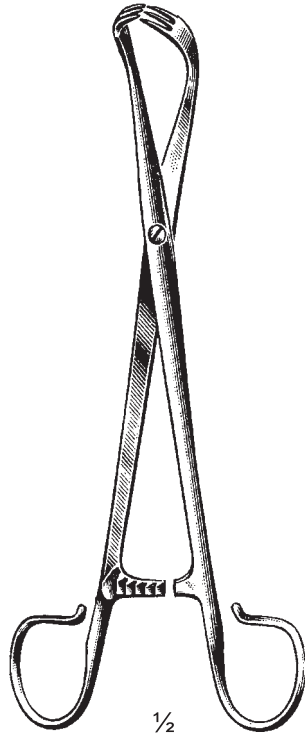

$\frac{1}{2}$
Marschik-Krone
594-03-20
20 cm / 8"



$\frac{1}{2}$
White
594-04-18 18 cm / 7"
594-05-23 23 cm / 9"

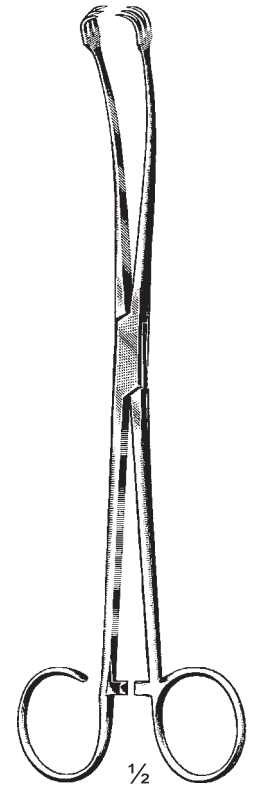

$\frac{1}{2}$
Ballenger
594-06-21
21.5 cm / 8½"

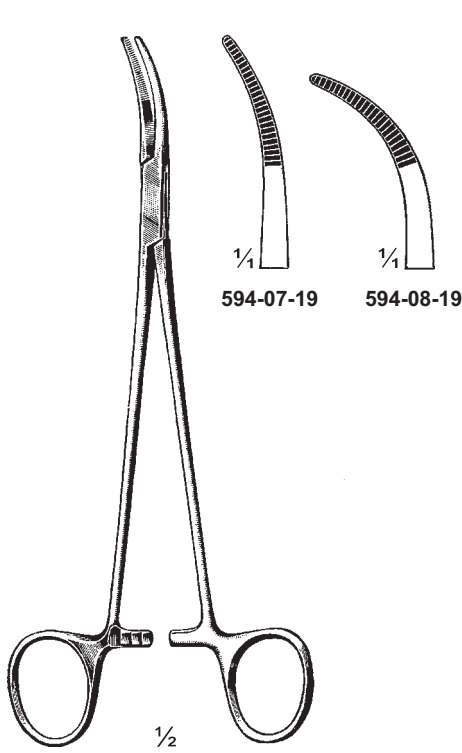

$\frac{1}{2}$
Schnidt
594-07-19 & 594-08-19
19 cm / 7½"

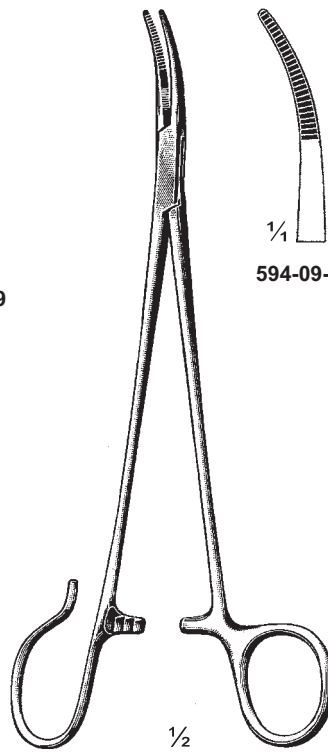

$\frac{1}{2}$
Schnidt
594-09-19 & 594-10-19
19 cm / 7½"

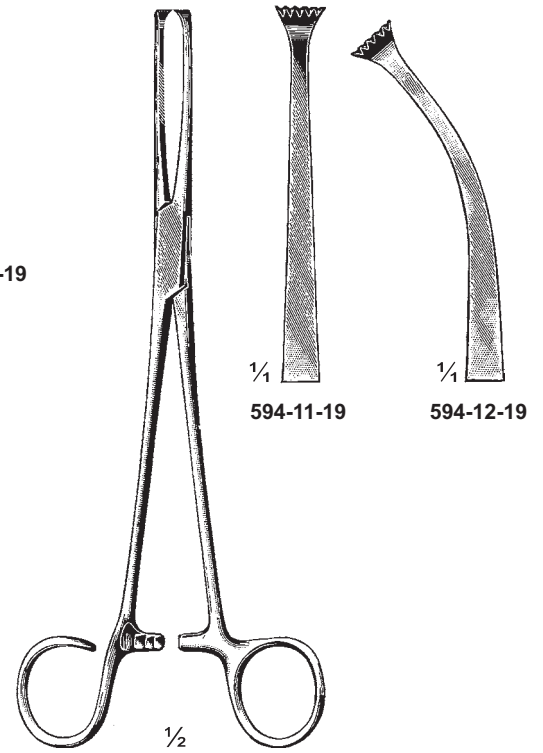

$\frac{1}{2}$
Colver
594-11-19 & 594-12-19
19 cm / 7½"

**Tonsillenklemmen
Tonsil Forceps
Pincettes pour amygdales**

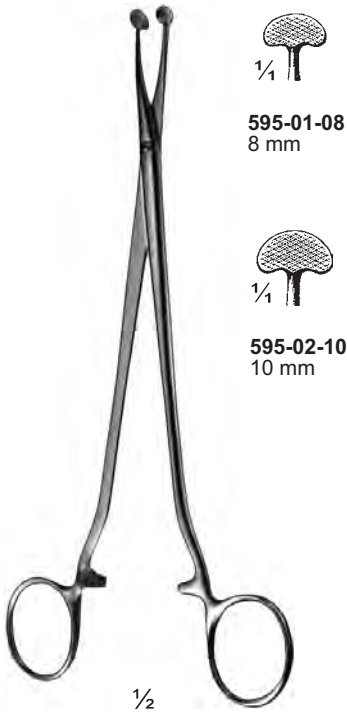

Muck
595-01-08 & 595-02-10
18 cm / 7"

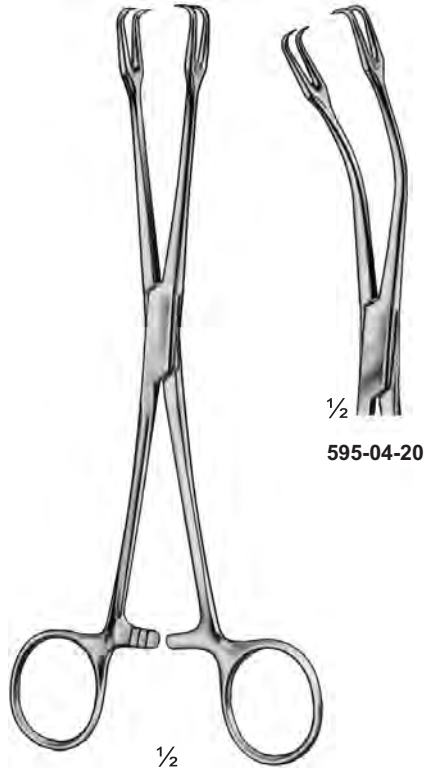

595-03-20
Museux
595-03-20 & 595-04-20
20 cm / 8"

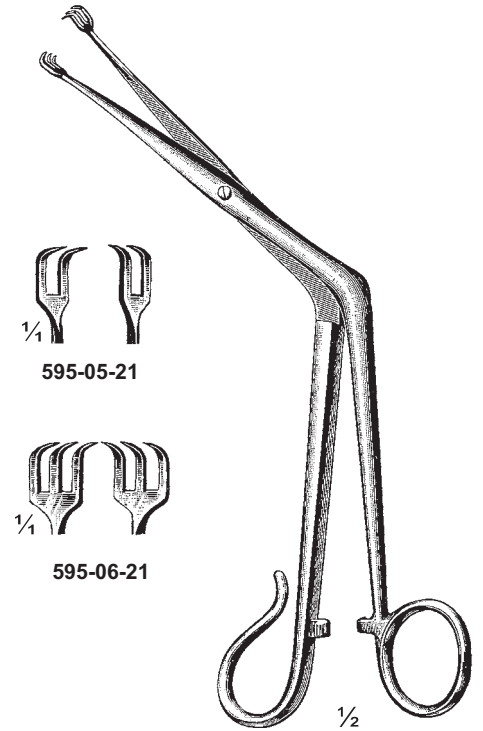

Tivnen-Tyding
595-05-21 & 595-06-21
21 cm / 8 1/4"

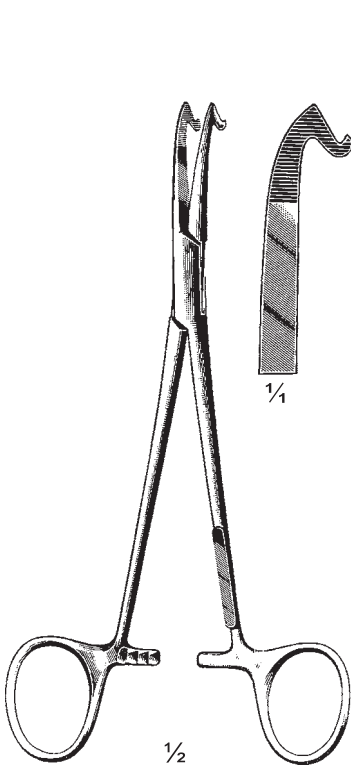

McWorther-Lothrop
595-07-18
18.5 cm / 7 1/4"

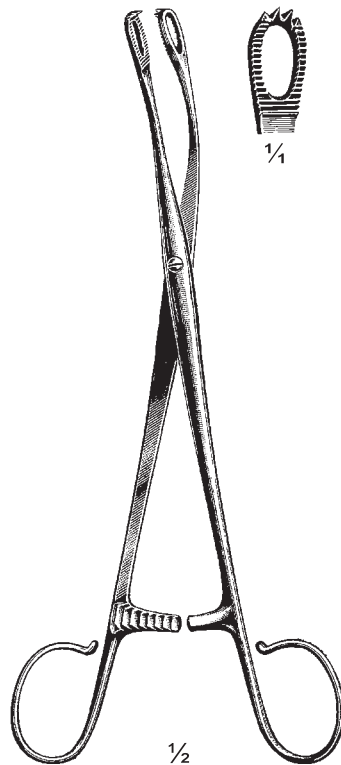

Blohmke
595-08-20
20 cm / 8"

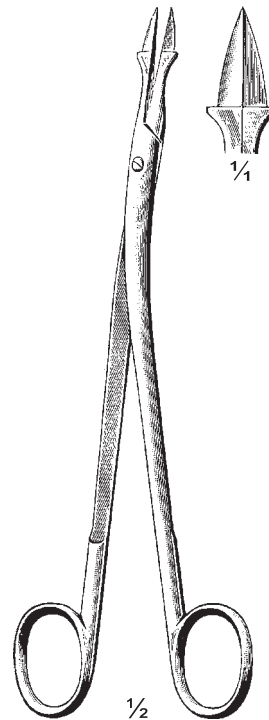

Thilenius
595-09-20
20 cm / 8"

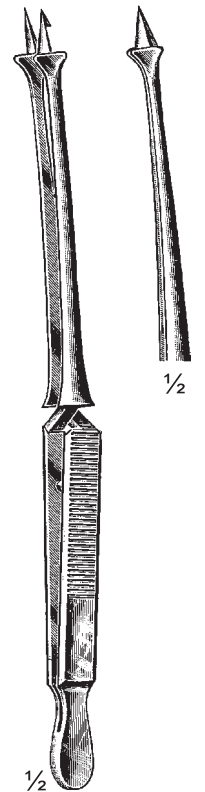

Leineweber
595-10-20
20 cm / 8"

Tonsillenschnürer
Tonsil Snares
Serre-noeuds pour amygdales

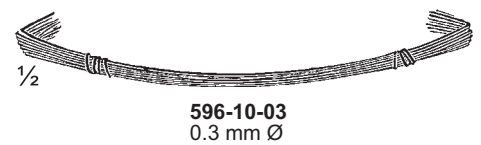
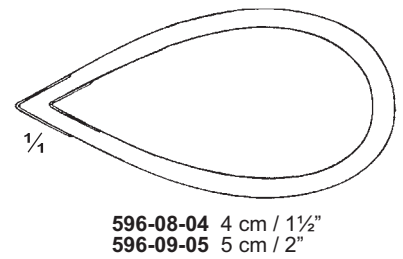
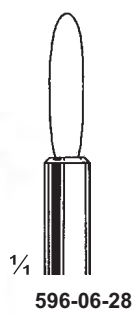
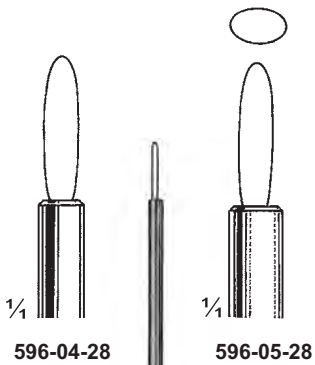
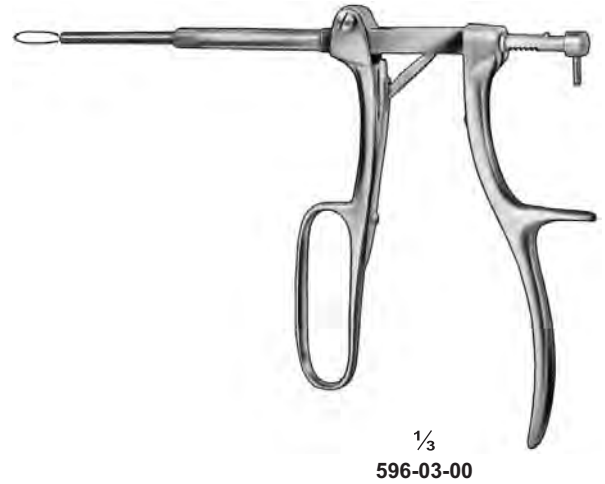
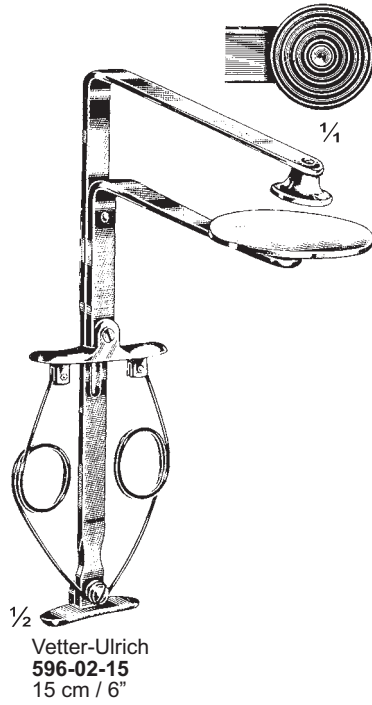
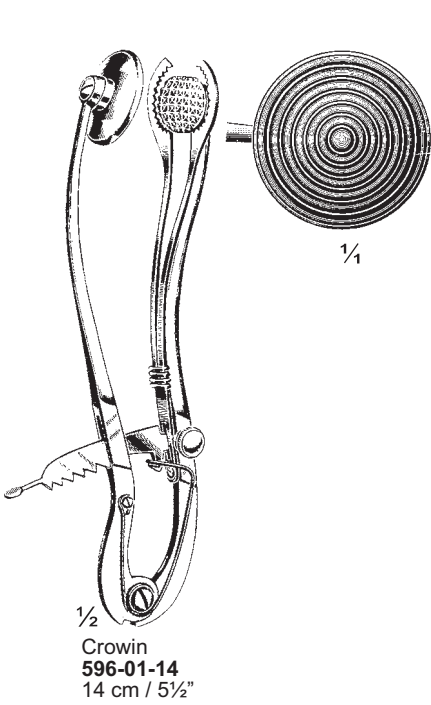

Tonsillenschnürer, Tonsillenzangen
Tonsil Snares, Tonsil Punches
Serre-noeuds pour amygdales, Pincettes pour amygdales

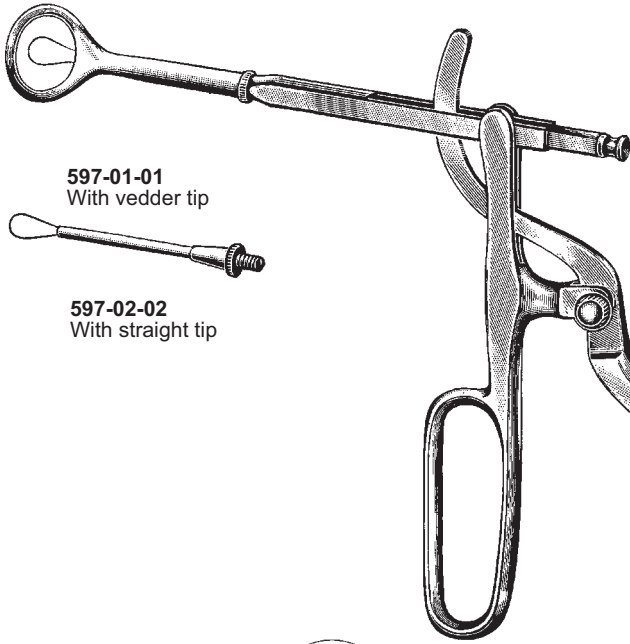

597-01-01
With vedder tip



597-02-02
With straight tip

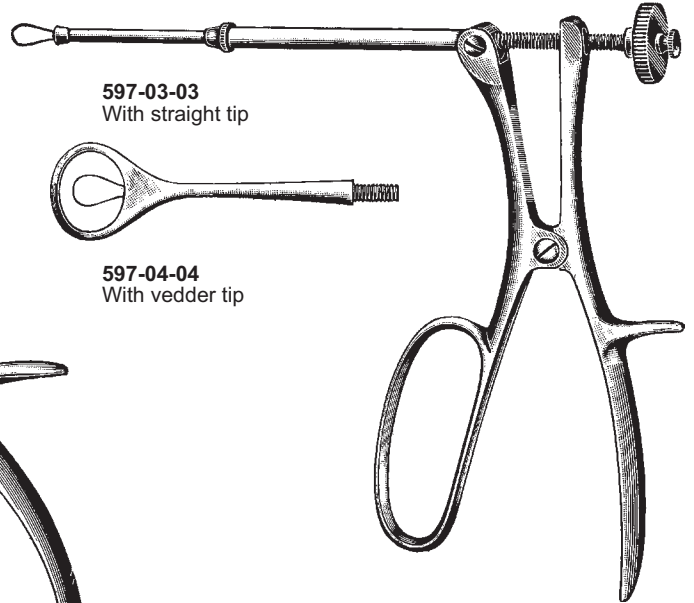

597-03-03
With straight tip



597-04-04
With vedder tip

Brown
597-03-03 & 597-04-04

Tyding
597-01-01 & 597-02-02

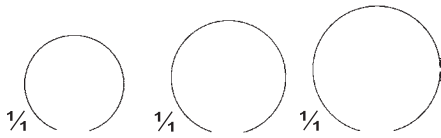

$\frac{1}{4}$
Hartmann
597-05-13
13 mm Ø

$\frac{1}{4}$
Hartmann
597-06-15
15 mm Ø

$\frac{1}{4}$
Hartmann
597-07-17
17 mm Ø

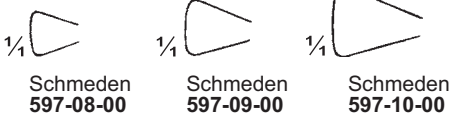

$\frac{1}{4}$
Schmeden
597-08-00

$\frac{1}{4}$
Schmeden
597-09-00

$\frac{1}{4}$
Schmeden
597-10-00

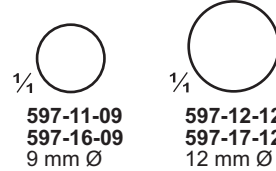

$\frac{1}{4}$
597-11-09
597-16-09
9 mm Ø

$\frac{1}{4}$
597-12-12
597-17-12
12 mm Ø

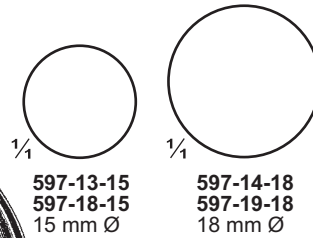

$\frac{1}{4}$
597-13-15
597-18-15
15 mm Ø

$\frac{1}{4}$
597-14-18
597-19-18
18 mm Ø

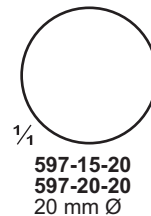

$\frac{1}{4}$
597-15-20
597-20-20
20 mm Ø



10 cm / 4"

$\frac{1}{2}$
597-05-13 To 597-10-00
21 cm / 8 $\frac{1}{4}$ "

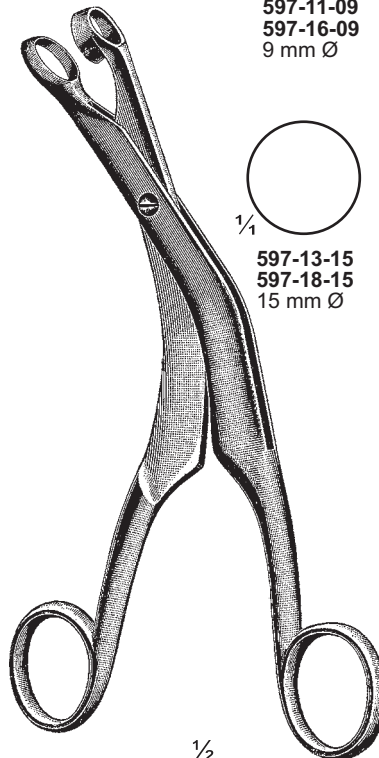

$\frac{1}{2}$
Ruault
597-11-09 To 597-15-20
21 cm / 8 $\frac{1}{4}$ "

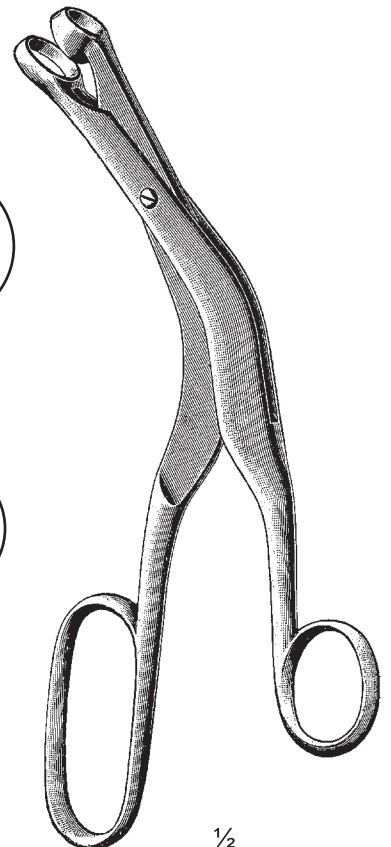

$\frac{1}{2}$
Ruault-Collin
597-16-09 To 597-20-20
22 cm / 8 $\frac{3}{4}$ "

**Tonsillenschnürer, Tonsillenzangen
Tonsil Snares, Tonsil Punches
Serre-noeuds pour amygdales, Pincés pour amygdales**

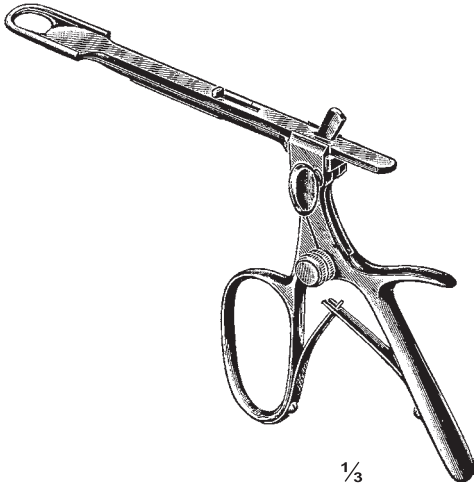

1/3

Sluder-Ballenger
598-01-01 To 598-03-03
598-04-03
Complete with 3 tips

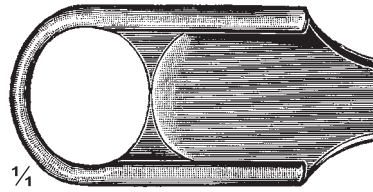

1/4

598-01-01
598-05-05

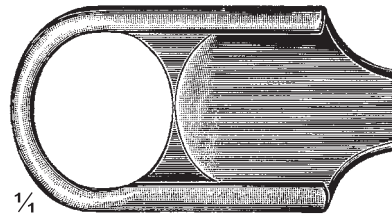

1/4

598-02-02
598-06-06

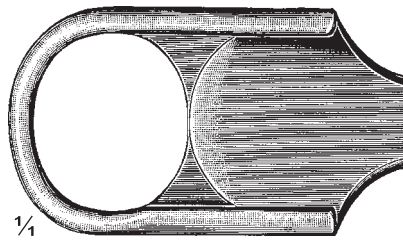

1/4

598-03-03
598-07-07

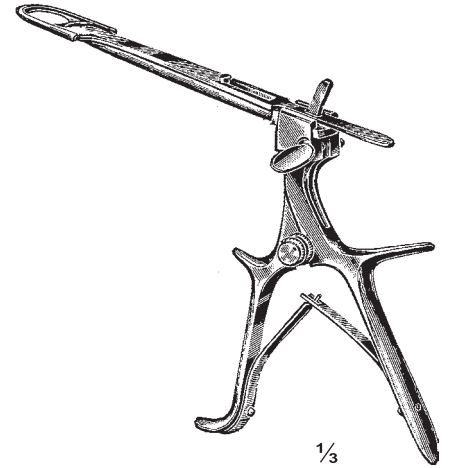

1/3

Sluder-Ballenger
598-05-05 To 598-07-07
598-08-03
Complete with 3 tips

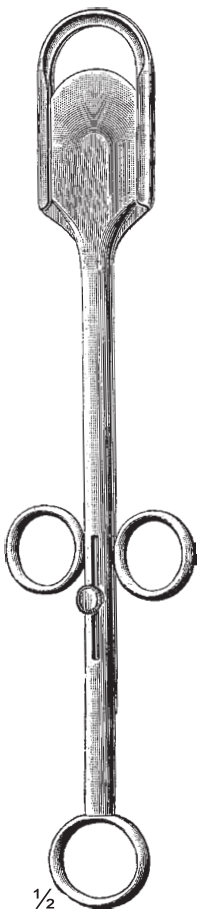

1/2

Baginsky
598-09-24
24 cm / 9 1/2"

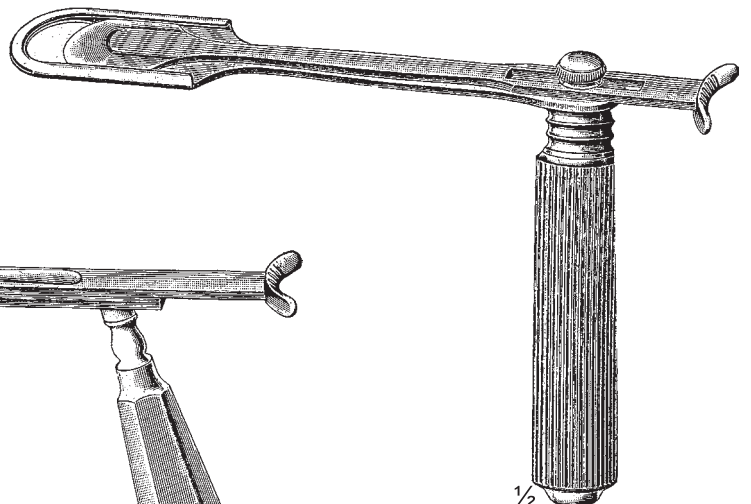

1/2

Mackenzie
598-11-00

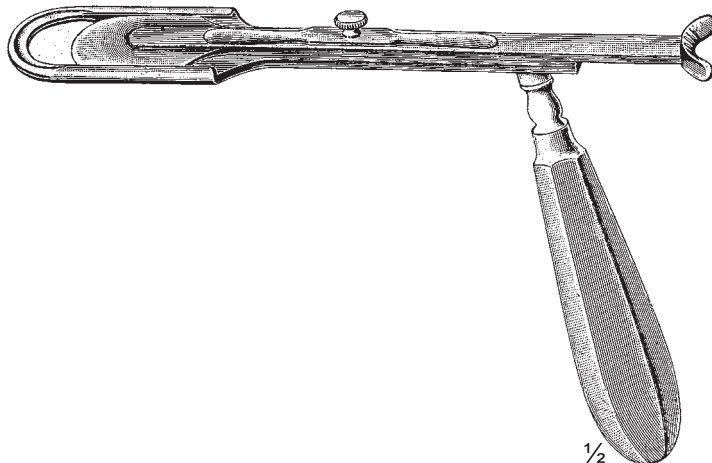

1/2

Mackenzie
598-10-00

Broncho-Oesophagoskopiezangen Broncho-Esophagoscopy Forceps Pincès Pour Broncho-Esophagoscopie

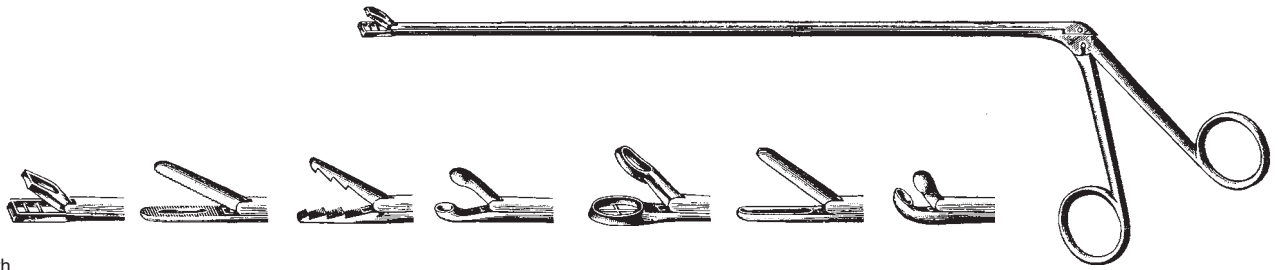

Shaft length

30 cm / 12"	599-01-30	599-05-30	599-09-30	599-13-30	599-17-30	599-21-30	599-25-30
40 cm / 16"	599-02-40	599-06-40	599-10-40	599-14-40	599-18-40	599-22-40	599-26-40
50 cm / 20"	599-03-50	599-07-50	599-11-50	599-15-50	599-19-50	599-23-50	599-27-50
60 cm / 24"	599-04-60	599-08-60	599-12-60	599-16-60	599-20-60	599-24-60	599-28-60

Chevalier-Jackson
599-01-30 To 599-28-60

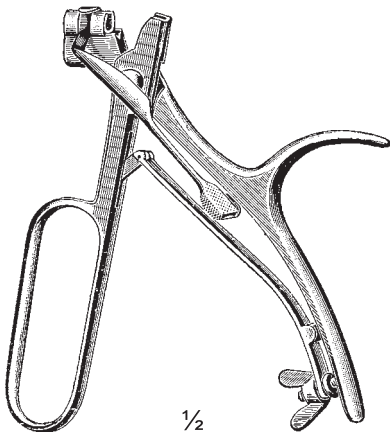

1/2

Huber
599-29-00

Available with tube 599-32-20 To 599-43-20
Available with tip 600-01-00 To 600-43-00

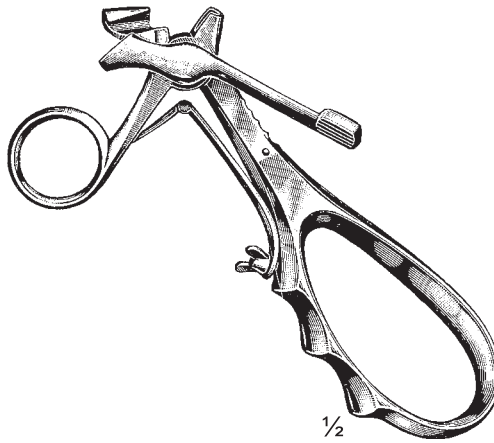

1/2

Bruenings
599-30-00

Available with tube 599-32-20 To 599-43-20
Available with tip 600-01-00 To 600-43-00

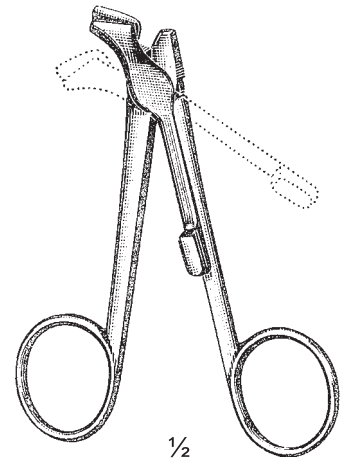

1/2

Yeoman
599-31-00

Available with tube 599-32-20 To 599-43-20
Available with tip 600-01-00 To 600-43-00



599-32-20	20 cm / 8"
599-33-30	30 cm / 12"
599-34-40	40 cm / 16"
599-35-50	50 cm / 20"
599-36-60	60 cm / 24"



599-37-20	20 cm / 8"
599-38-30	30 cm / 12"
599-39-40	40 cm / 16"
599-40-50	50 cm / 20"
599-41-60	60 cm / 24"

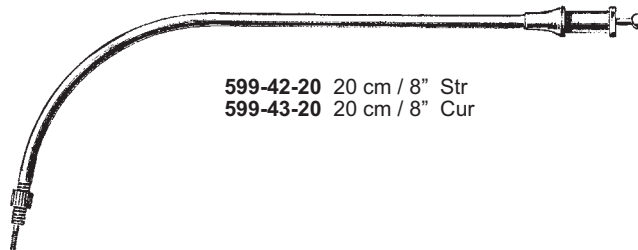

599-42-20	20 cm / 8" Str
599-43-20	20 cm / 8" Cur

Broncho-Oesophagoskopiezangen Broncho-Esophagoscopy Forceps Pincettes Pour Broncho-Esophagoscopie



Fraenkel
600-01-00



Fraenkel
600-02-00



Fraenkel
600-03-00

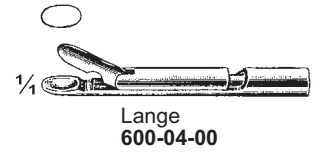

Lange
600-04-00



Fraenkel
600-05-00



Scheinmann
600-06-00



Krause
600-07-00



Scheinmann
600-08-00



Eicken
600-09-00



Seiffert
600-10-00

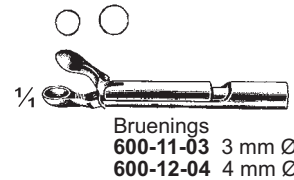

Bruenings
600-11-03 3 mm Ø
600-12-04 4 mm Ø

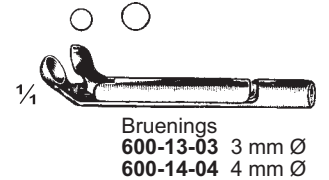

Bruenings
600-13-03 3 mm Ø
600-14-04 4 mm Ø

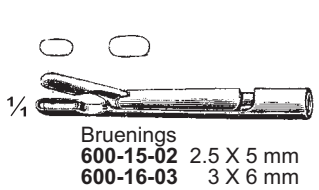

Bruenings
600-15-02 2.5 X 5 mm
600-16-03 3 X 6 mm

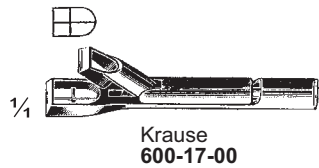

Krause
600-17-00

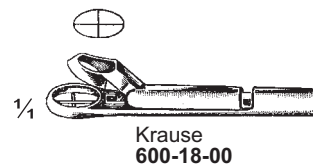

Krause
600-18-00

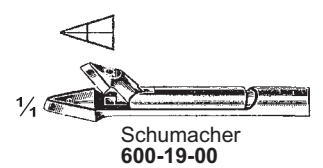

Schumacher
600-19-00

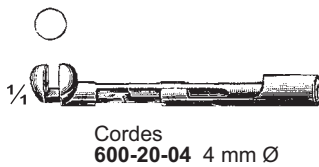

Cordes
600-20-04 4 mm Ø

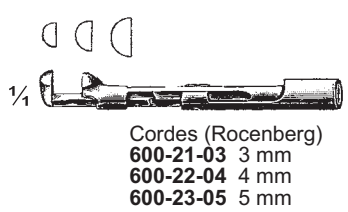

Cordes (Rocenberg)
600-21-03 3 mm
600-22-04 4 mm
600-23-05 5 mm

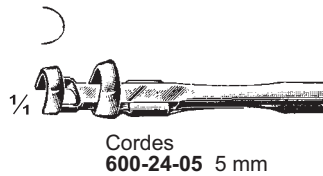

Cordes
600-24-05 5 mm

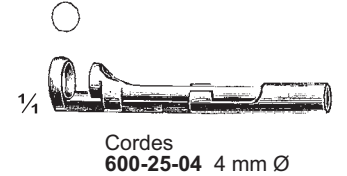

Cordes
600-25-04 4 mm Ø



Fraenkel
600-26-00



Eicken
600-27-00

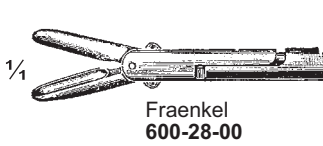

Fraenkel
600-28-00

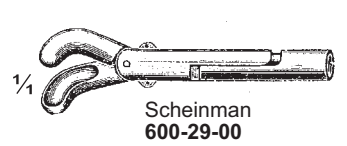

Scheinmann
600-29-00

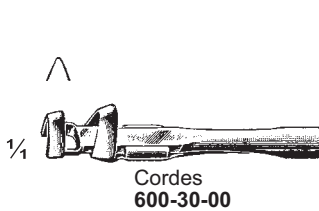

Cordes
600-30-00

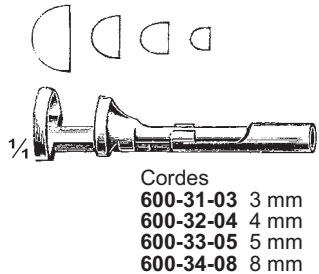

Cordes
600-31-03 3 mm
600-32-04 4 mm
600-33-05 5 mm
600-34-08 8 mm

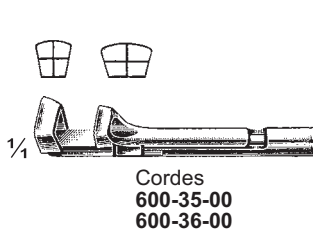

Cordes
600-35-00
600-36-00

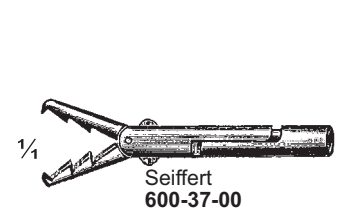

Seiffert
600-37-00

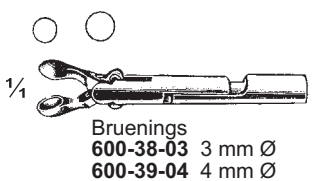

Bruenings
600-38-03 3 mm Ø
600-39-04 4 mm Ø

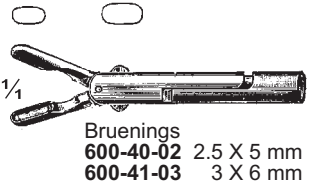

Bruenings
600-40-02 2.5 X 5 mm
600-41-03 3 X 6 mm

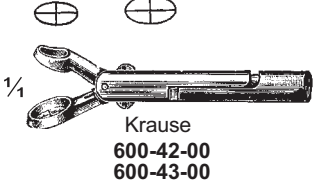

Krause
600-42-00
600-43-00

Broncho-Oesophagoskopiezangen Broncho-Esophagoscopy Forceps Pincers Pour Broncho-Esophagoscopie



Jaw 2 mm

Rintne Hospital
601-01-35
35 cm / 14"

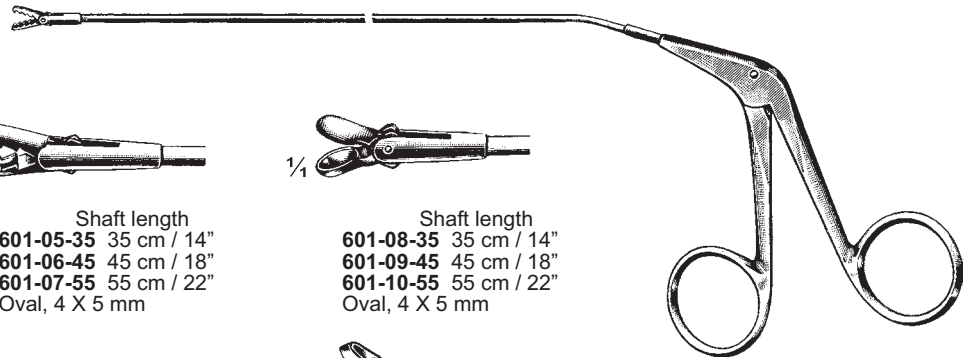

601-02-35 To 601-22-55

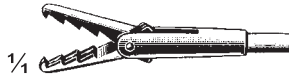

Shaft length
601-02-35 35 cm / 14"
601-03-45 45 cm / 18"
601-04-55 55 cm / 22"



Shaft length
601-05-35 35 cm / 14"
601-06-45 45 cm / 18"
601-07-55 55 cm / 22"
Oval, 4 X 5 mm

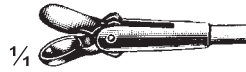

Shaft length
601-08-35 35 cm / 14"
601-09-45 45 cm / 18"
601-10-55 55 cm / 22"
Oval, 4 X 5 mm

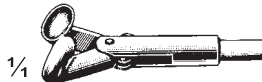

Shaft length
601-11-35 35 cm / 14"
601-12-45 45 cm / 18"
601-13-55 55 cm / 22"



Shaft length
601-14-35 35 cm / 14"
601-15-45 45 cm / 18"
601-16-55 55 cm / 22"



Shaft length
601-17-35 35 cm / 14"
601-18-45 45 cm / 18"
601-19-55 55 cm / 22"
Oval, 3 X 5 mm



Shaft length
601-21-35 35 cm / 14"
601-21-45 45 cm / 18"
601-22-55 55 cm / 22"



601-23-45



601-24-45



601-25-45



Tucker
601-26-45



601-27-45



601-28-45



601-29-45

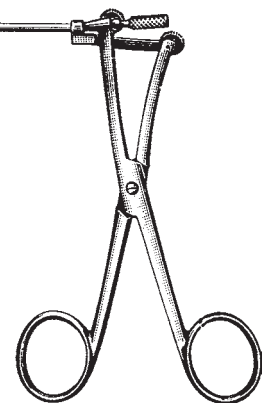

Original-Jackson
601-23-45 To 601-29-45
45 cm / 18"
4 mm Ø

Broncho-Oesophagoskopiezangen Broncho-Esophagoscopy Forceps Pincers Pour Broncho-Esophagoscopie



602-01-24
Shaft 24 cm / 9½"



602-02-24
Shaft 24 cm / 9½"

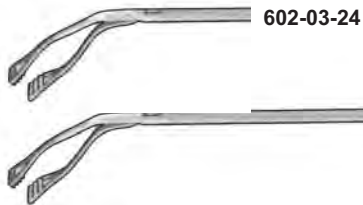

602-03-24

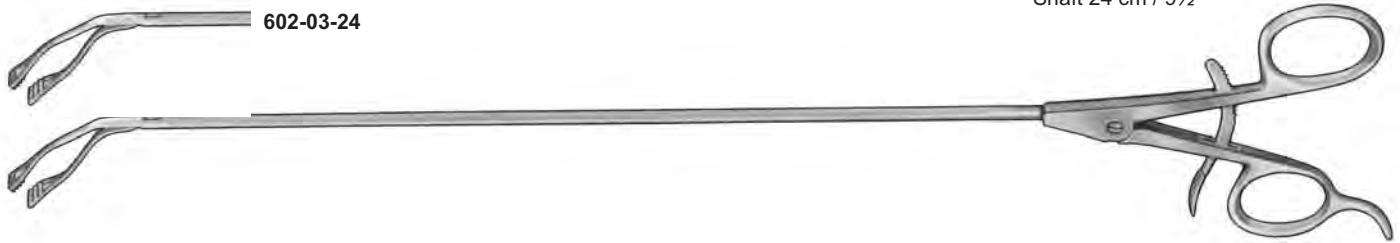

602-04-24
Scissors



602-05-24
Scissors



602-06-24

602-03-24 To 602-09-24
Shaft 24 cm / 9½"
30°



602-07-24



602-08-24



602-09-24



Chevalier-Jackson
602-10-30 30 cm / 12"
Serrated jaw



Chevalier-Jackson
602-11-30 30 cm / 12"
602-12-35 35 cm / 14"
602-13-40 40 cm / 16"
602-14-50 50 cm / 20"
Scooped serrated
jaw



Chevalier-Jackson
602-15-30 30 cm / 12"
602-16-35 35 cm / 14"
602-17-40 40 cm / 16"
602-18-50 50 cm / 20"
Scooped serrated
jaw, light weight



602-10-30 To 602-33-50



Chevalier-Jackson
602-19-28 28 cm / 11"
602-20-35 35 cm / 14"
602-21-40 40 cm / 16"
602-22-50 50 cm / 20"
Upward cur cup jaws



Chevalier-Jackson
602-23-30 30 cm / 12"
602-24-40 40 cm / 16"
Cur to upward, round
cup jaw, light weight



Peterson
602-25-30 30 cm / 12"
602-26-35 35 cm / 14"
602-27-40 40 cm / 16"
602-28-45 45 cm / 18"
602-29-50 50 cm / 20"
Scooped jaw



Peterson
602-30-30 30 cm / 12"
602-31-35 35 cm / 14"
602-32-45 45 cm / 18"
602-33-50 50 cm / 20"
Scooped jaw,
Light weight

Broncho-Oesophagoskopiezangen Broncho-Esophagoscopy Forceps Pincettes Pour Broncho-Esophagoscopie



603-01-40



603-02-40



603-03-40

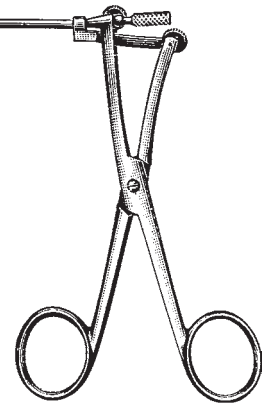

Original-Jackson
603-01-40 To 603-03-40
40 cm / 16"
3 mm Ø

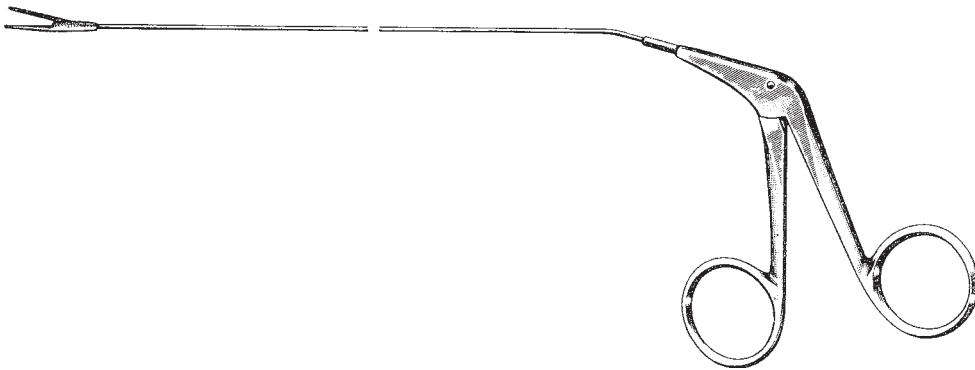

603-01-24 To 603-25-24
Shaft 24 cm / 9½"



603-04-24
Str



603-05-24
Cur to upward



603-06-24
Cur to left



603-07-24
Cur to right



603-08-24
Str horizontal
blades



603-09-24
Str



603-10-24
Cur to left



603-11-24
Cur to right



603-12-24
Str



603-13-24
Cur to upward



603-14-24
Cur to left



603-15-24
Cur to right



603-16-24
Cur to left



603-17-24
Cur to upward



603-18-24
Cur to right



603-19-24
Str



603-20-24
Cur to upward



603-21-24
Cur to right



603-22-24
Str horizontal
jaws



603-23-24



603-24-24



603-25-24

**Broncho-Oesophagoskopiezangen
Broncho-Esophagoscopy Forceps
Pincers Pour Broncho-Esophagoscopie**

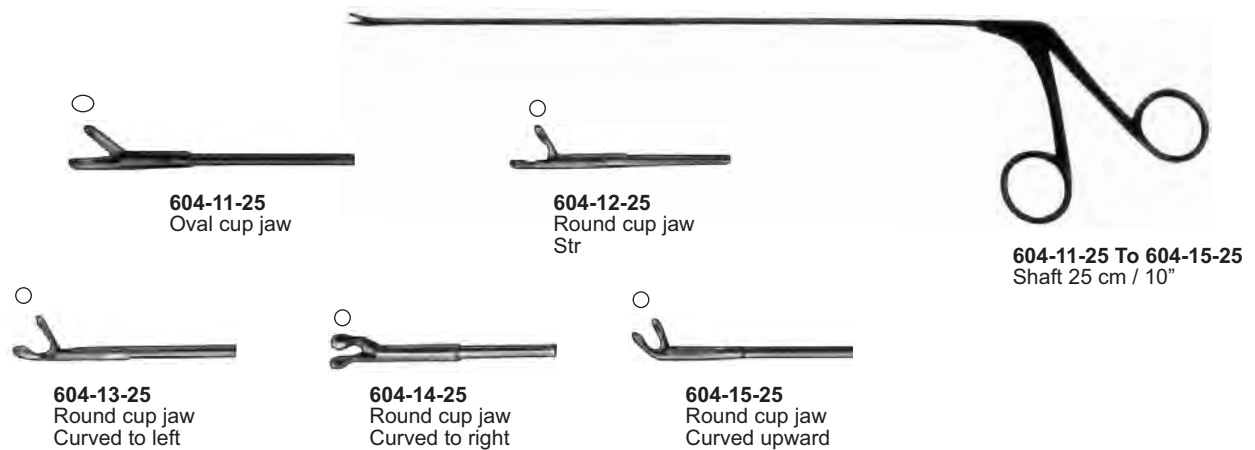
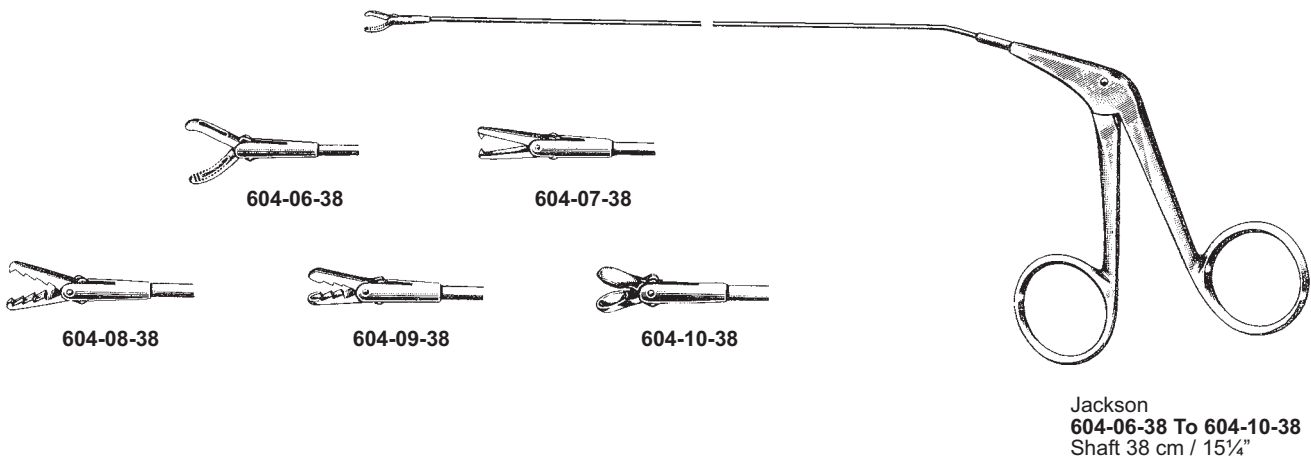
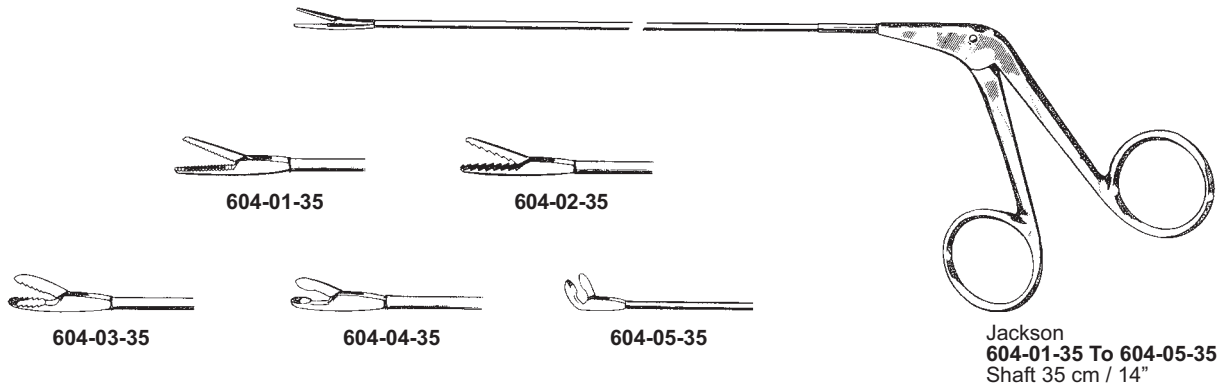

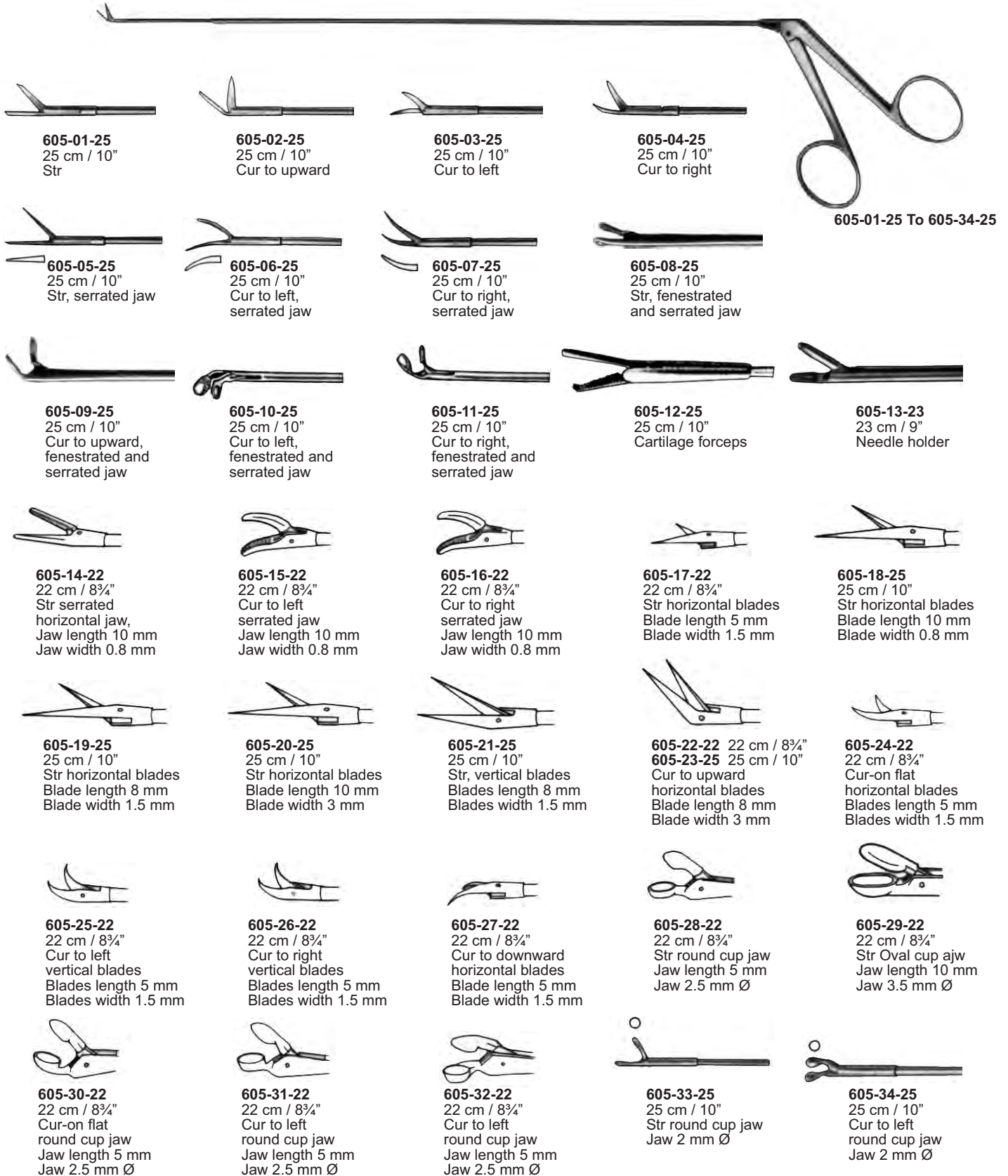

Laryngeal Zange Laryngeal Forceps Forceps Larynges



606-01-15
Str serrated jaw
Jaw length 4 mm
Jaw width 1 mm



606-02-15
Str serrated jaw
Jaw length 8 mm
Jaw width 1 mm



606-03-15
Curved to left
Serrated jaw
Jaw length 4 mm
Jaw width 1 mm



606-04-15
Curved to right
Serrated jaw
Jaw length 4 mm
Jaw width 1 mm

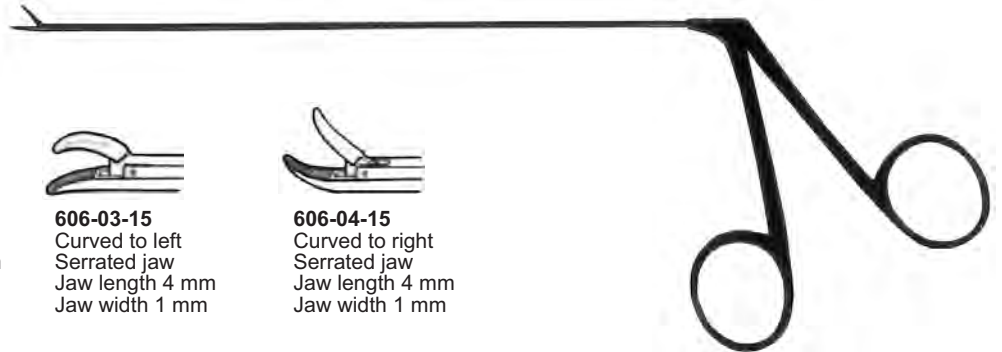

606-01-15 To 606-07-15
Shaft length 15 cm / 6"



606-05-15
Str
Blade length 4 mm
Blade width 1.5 mm



606-06-15
Curved to left
Blade length 4 mm
Blade width 1.5 mm



606-07-15
Curved to right
Blade length 4 mm
Blade width 1.5 mm



Mackay
606-08-12
Shaft length 12 cm / 4¾"
Angled to right
Blades length 10 mm



Mackay
606-09-12
Shaft length 12 cm / 4¾"
Str, blades length 10 mm



Mackay-Chomper
606-10-12
Shaft length 12 cm / 4¾"
Bite 9 X 4 mm

Trachealtrokar Tracheal Trocars Trocart pour la trachéotomie

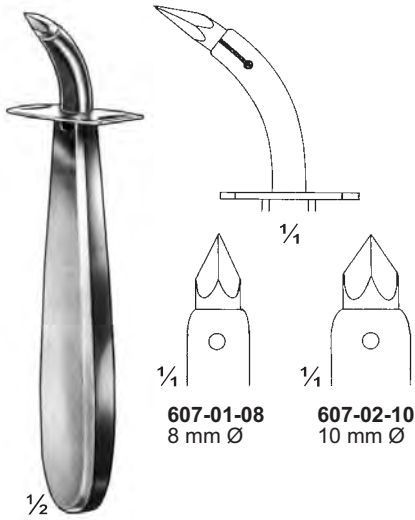

Uckermann
607-01-08 & 607-02-10
13 cm / 5 1/8"



Trousseau
607-03-12
12 cm / 4 3/4"

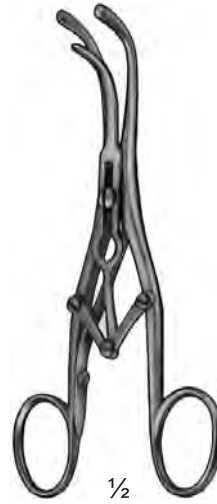

Laborde
607-04-12
12.5 cm / 5"

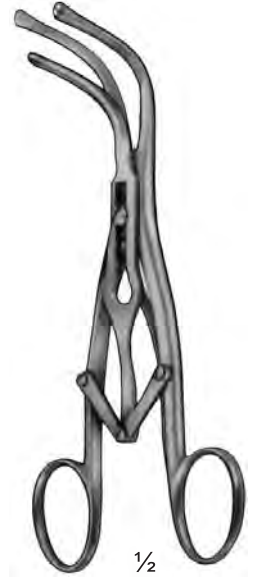

Laborde
607-05-13
13.5 cm / 5 1/4"
Strong pattern



607-06-24

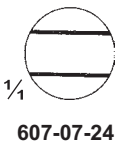

607-07-24



607-06-24 & 607-07-24
24 cm / 9 1/2"



Weedra
607-08-19
19 cm / 7 1/2"

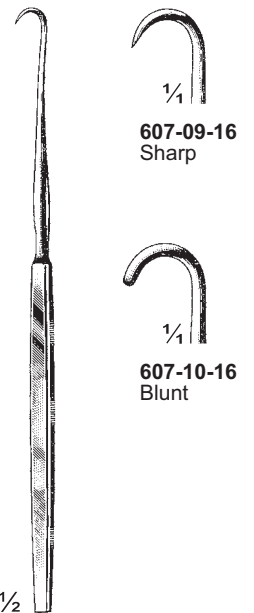

Iterson
607-09-16 & 607-10-16
16 cm / 6 1/4"

Trachealthaken Tracheal Hooks Ecarteurs pour trachéotomie

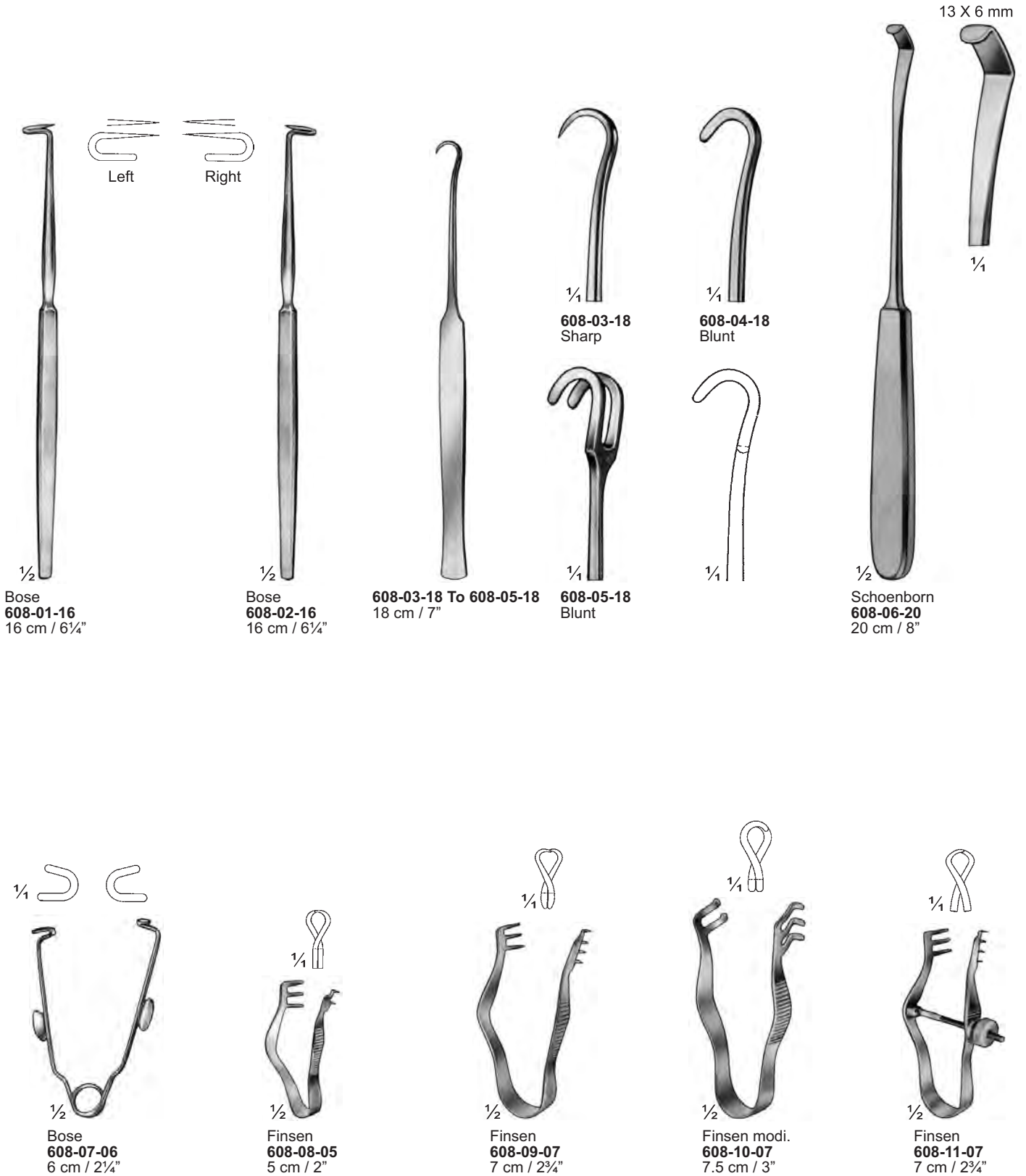

**Trachealthaken
Tracheal Hooks
Ecarteurs pour trachéotomie**

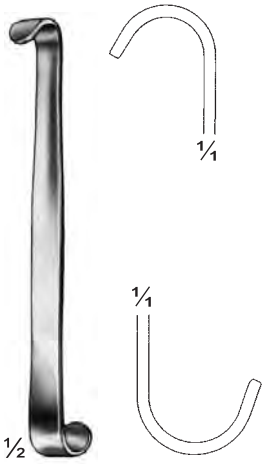

Luer
609-01-11
11 cm / 4¼"

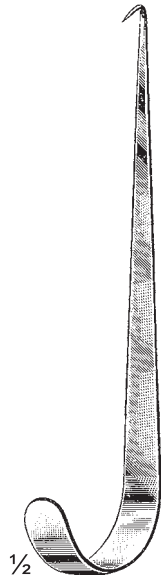

Jackson
609-02-15
15 cm / 6"

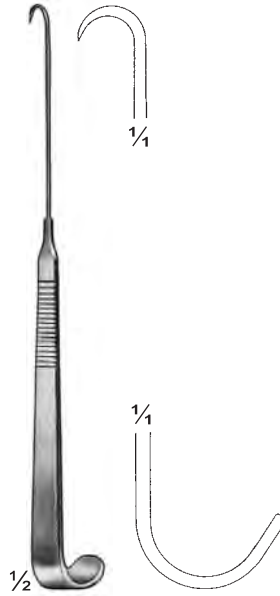

609-03-15
15 cm / 6"

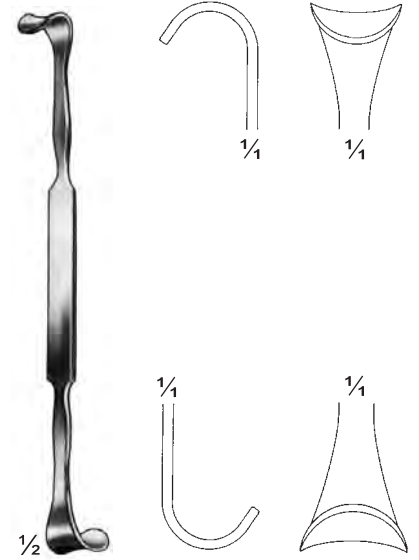

Rose
609-04-13
13 cm / 5⅝"



Jackson
609-05-18
18 cm / 7"

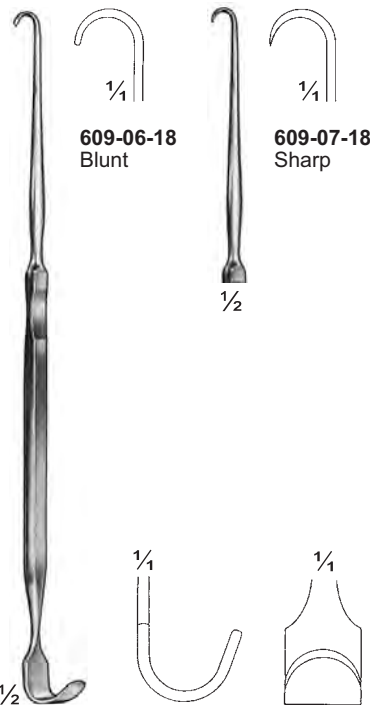

Jackson
609-06-18 & 609-07-18
18 cm / 7"



Lukens
609-08-17
17 cm / 6¾"

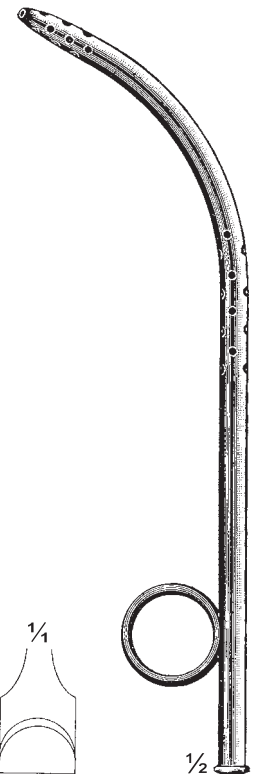

Wagener-Mosher
609-09-05 5 mm Ø
609-10-07 7 mm Ø
609-11-09 9 mm Ø
21 cm / 8¼"



Jackson			
Stainless steel			German silver
610-01-04	Fig. 0	4 Ø X 50 mm	610-12-04
610-02-05	Fig. 1	5 Ø X 48 mm	610-13-05
610-03-06	Fig. 2	6 Ø X 58 mm	610-14-06
610-04-07	Fig. 3	7 Ø X 70 mm	610-15-07
610-05-08	Fig. 4	8 Ø X 78 mm	610-16-08
610-06-09	Fig. 5	9 Ø X 84 mm	610-17-09
610-07-10	Fig. 6	10 Ø X 84 mm	610-18-10
610-08-11	Fig. 7	11 Ø X 86 mm	610-19-11
610-09-12	Fig. 8	12 Ø X 88 mm	610-20-12
610-10-13	Fig. 9	13 Ø X 90 mm	610-21-13
610-11-14	Fig. 10	14 Ø X 90 mm	610-22-14



Stainless steel			German silver
610-23-09	Fig. 5	9 Ø X 65 mm	610-26-09
610-24-10	Fig. 6	10 Ø X 70 mm	610-27-10
610-25-11	Fig. 7	11 Ø X 80 mm	610-28-11



Chevalier-Jackson			
Stainless steel			German silver
610-29-04	Fig. 0	4 Ø X 50 mm	610-40-04
610-30-05	Fig. 1	5 Ø X 48 mm	610-41-05
610-31-06	Fig. 2	6 Ø X 58 mm	610-42-06
610-32-07	Fig. 3	7 Ø X 70 mm	610-43-07
610-33-08	Fig. 4	8 Ø X 78 mm	610-44-08
610-34-09	Fig. 5	9 Ø X 84 mm	610-45-09
610-35-10	Fig. 6	10 Ø X 84 mm	610-46-10
610-36-11	Fig. 7	11 Ø X 86 mm	610-47-11
610-37-12	Fig. 8	12 Ø X 88 mm	610-48-12
610-38-13	Fig. 9	13 Ø X 90 mm	610-49-13
610-39-14	Fig. 10	14 Ø X 90 mm	610-50-14



Collin			
Stainless steel			German silver
610-51-04	Fig. 0	4 Ø X 50 mm	610-62-04
610-52-05	Fig. 1	5 Ø X 48 mm	610-63-05
610-53-06	Fig. 2	6 Ø X 58 mm	610-64-06
610-54-07	Fig. 3	7 Ø X 70 mm	610-65-07
610-55-08	Fig. 4	8 Ø X 78 mm	610-66-08
610-56-09	Fig. 5	9 Ø X 84 mm	610-67-09
610-57-10	Fig. 6	10 Ø X 84 mm	610-68-10
610-58-11	Fig. 7	11 Ø X 86 mm	610-69-11
610-59-12	Fig. 8	12 Ø X 88 mm	610-70-12
610-60-13	Fig. 9	13 Ø X 90 mm	610-71-13
610-61-14	Fig. 10	14 Ø X 90 mm	610-72-14



Luer		German silver
Stainless steel		
611-01-08 Fig. 4	8 Ø X 65 mm	611-07-08
611-02-09 Fig. 5	9 Ø X 70 mm	611-08-09
611-03-10 Fig. 6	10 Ø X 75 mm	611-09-10
611-04-11 Fig. 7	11 Ø X 80 mm	611-10-11
611-05-12 Fig. 8	12 Ø X 85 mm	611-11-12
611-06-13 Fig. 9	13 Ø X 90 mm	611-12-13

Luer		German silver
Stainless steel		
611-13-08 Fig. 4	8 Ø X 65 mm	611-19-08
611-14-09 Fig. 5	9 Ø X 70 mm	611-20-09
611-15-10 Fig. 6	10 Ø X 75 mm	611-21-10
611-16-11 Fig. 7	11 Ø X 80 mm	611-22-11
611-17-12 Fig. 8	12 Ø X 85 mm	611-23-12
611-18-13 Fig. 9	13 Ø X 90 mm	611-24-13



Luer		German silver
Stainless steel		
611-25-08 Fig. 4	8 Ø X 65 mm	611-31-08
611-26-09 Fig. 5	9 Ø X 70 mm	611-32-09
611-27-10 Fig. 6	10 Ø X 75 mm	611-33-10
611-28-11 Fig. 7	11 Ø X 80 mm	611-34-11
611-29-12 Fig. 8	12 Ø X 85 mm	611-35-12
611-30-13 Fig. 9	13 Ø X 90 mm	611-36-13

Krishaber		German silver
Stainless steel		
611-37-04 Fig. 0	4 Ø X 50 mm	610-46-04
611-38-05 Fig. 1	5 Ø X 48 mm	610-47-05
611-39-06 Fig. 2	6 Ø X 58 mm	610-48-06
611-40-07 Fig. 3	7 Ø X 70 mm	610-49-07
611-41-08 Fig. 4	8 Ø X 65 mm	611-50-08
611-42-09 Fig. 5	9 Ø X 70 mm	611-51-09
611-43-10 Fig. 6	10 Ø X 75 mm	611-52-10
611-44-11 Fig. 7	11 Ø X 80 mm	611-53-11
611-45-12 Fig. 8	12 Ø X 85 mm	611-54-12

Krishaber-Luer		German silver
Stainless steel		
611-55-04 Fig. 0	4 Ø X 50 mm	610-64-04
611-56-05 Fig. 1	5 Ø X 48 mm	610-65-05
611-57-06 Fig. 2	6 Ø X 58 mm	610-66-06
611-58-07 Fig. 3	7 Ø X 70 mm	610-67-07
611-59-08 Fig. 4	8 Ø X 65 mm	611-68-08
611-60-09 Fig. 5	9 Ø X 70 mm	611-69-09
611-61-10 Fig. 6	10 Ø X 75 mm	611-70-10
611-62-11 Fig. 7	11 Ø X 80 mm	611-71-11
611-63-12 Fig. 8	12 Ø X 85 mm	611-72-12



Schroetter
612-01-01
Fig. 1



Schroetter
612-02-02
Fig. 2



Schroetter
612-03-03
Fig. 3



Schroetter
612-04-04
Fig. 4



Schroetter
612-05-05
Fig. 5



Schroetter
612-06-06
Fig. 6



Schroetter
612-07-07
Fig. 7

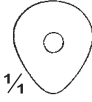

Schroetter
612-08-08
Fig. 8



Schroetter
612-09-09
Fig. 9



Schroetter
612-10-10
Fig. 10



Schroetter
612-11-11
Fig. 11



Schroetter
612-12-12
Fig. 12

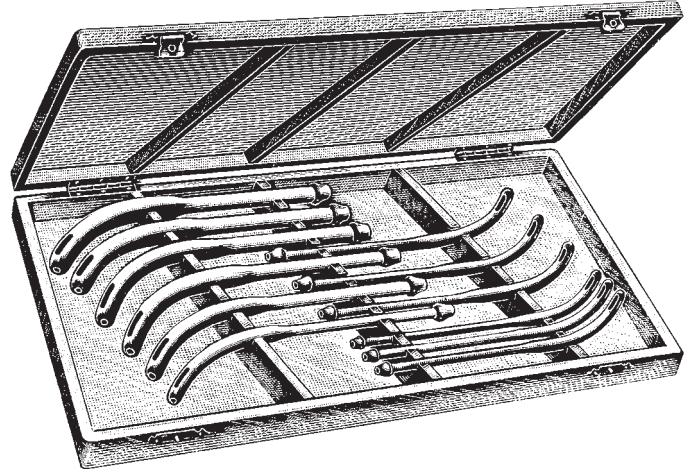

Schroetter
Complete consisting:
12 Schroetter dialators 612-01-01 To 612-12-12
612-13-00 Packed in wooden case
612-14-00 Packed in stainless case

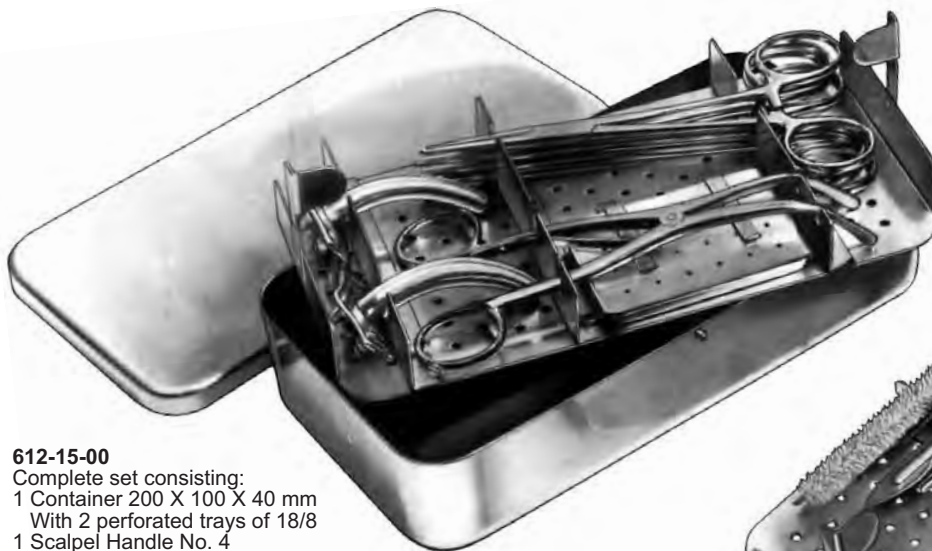

612-15-00

Complete set consisting:

- 1 Container 200 X 100 X 40 mm
- With 2 perforated trays of 18/8
- 1 Scalpel Handle No. 4
- 1 Scalpel Blade No. 23
- 3 Scalpel Blades, assorted
- 1 Small case for above scalpel blades
- 1 Dressing Forceps, 13cm, Serrated
- 2 Tissue Forceps, 13cm, 1x2 Teeth
- 4 Crile Forceps, 14cm, Str
- 1 Grooved Director, 13cm
- 1 Trousseau Trachea Dilator, 14cm
- 2 Iterson Trachea Hooks, Blunt
- 1 Bose Hook, Sharp, Left hand side, 16cm
- 1 Bose Hook, Sharp, Right hand side, 16cm
- 1 Luer Trachea Tube, size 2.6 mm dia, German Silver
- 1 Luer Trachea Tube, size 4.8 mm dia, German Silver
- 1 Cleaning Brush, 12 mm dia, 27cm
- 1 Plastic Pouch for this set



**Nasenspekula
Nasal Speculam
Spéculums nasaux**

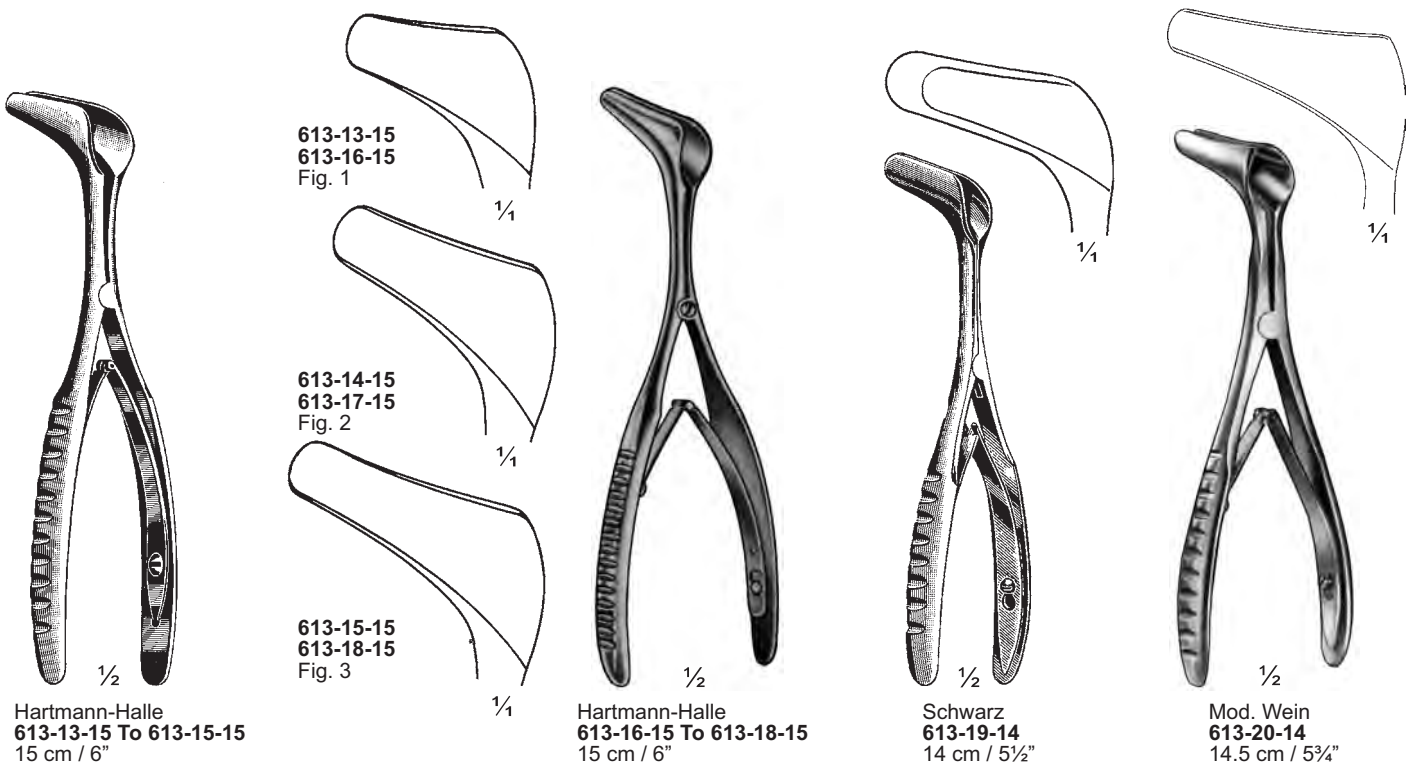
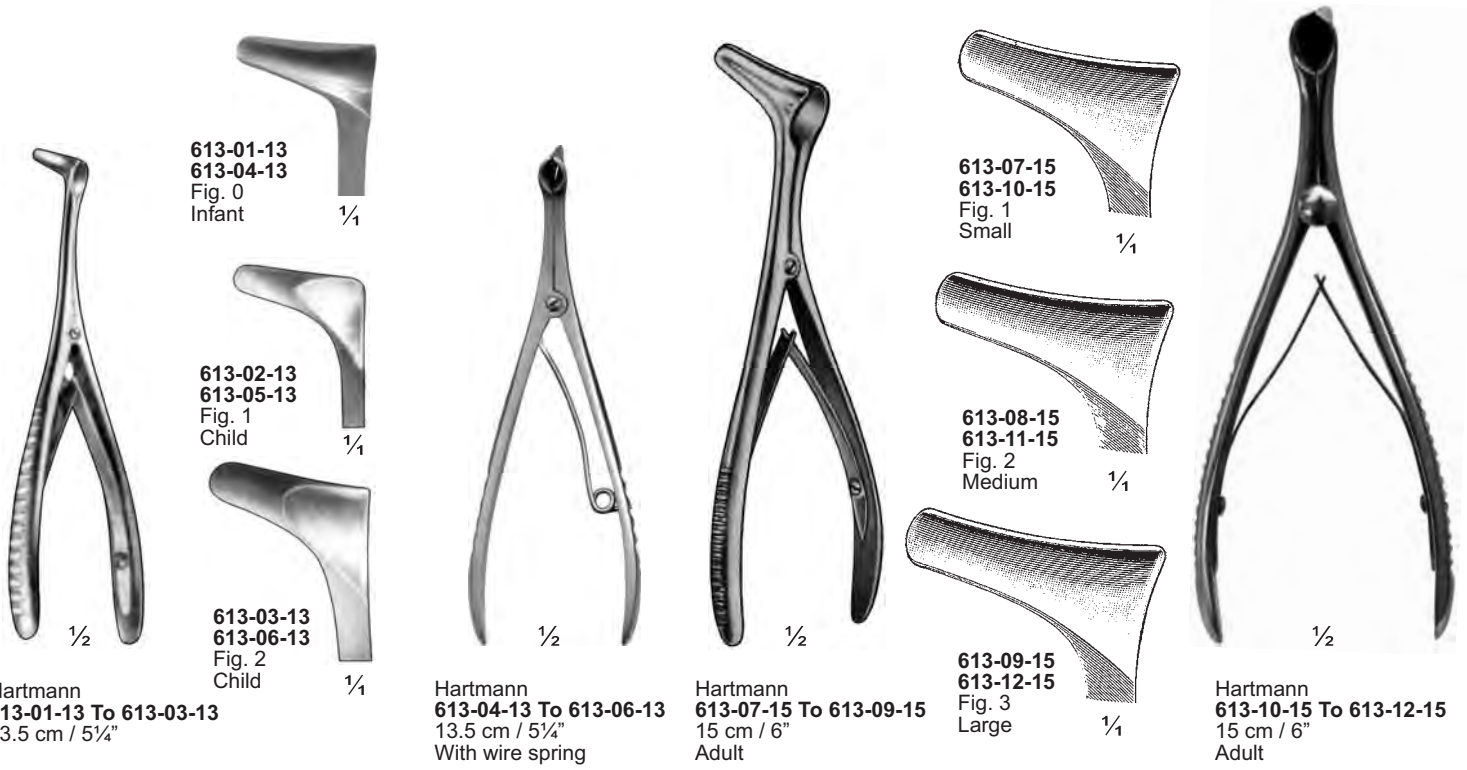

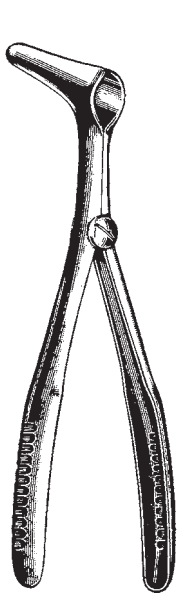

Vienna
614-01-14 To 614-03-14
14.5 cm / 5¾"
Light weight

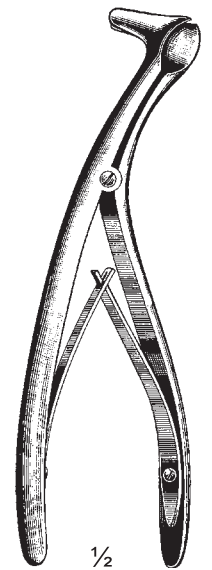
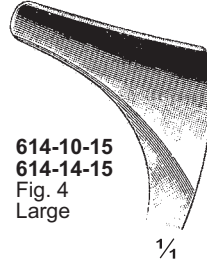
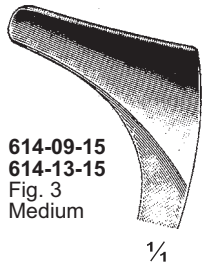
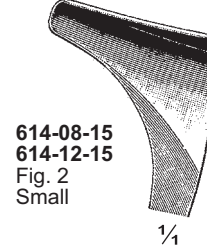
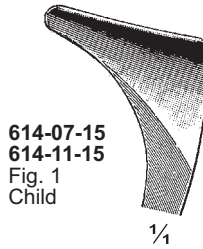
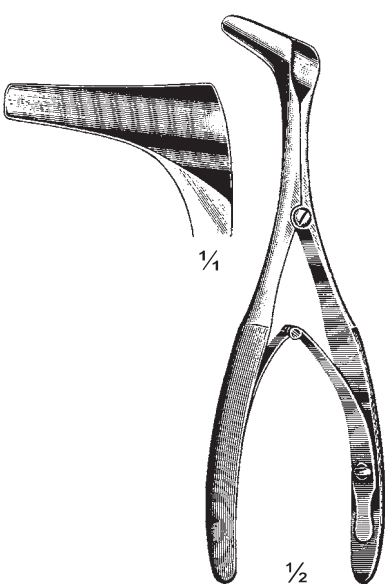
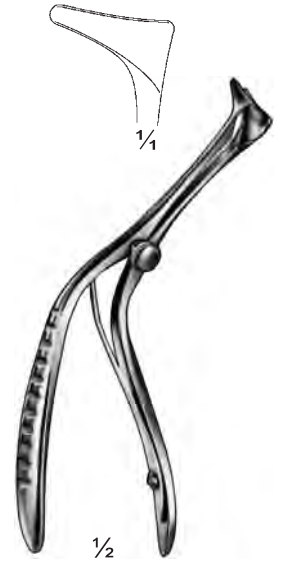
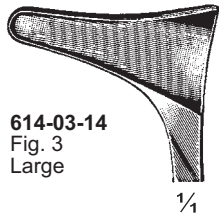
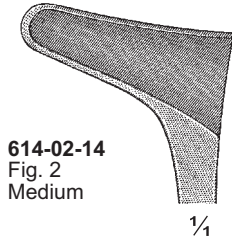
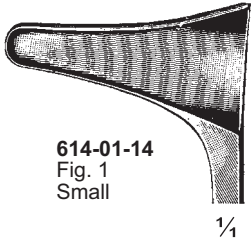



615-01-35
615-05-35
615-09-35
Fig. 1, 35 mm

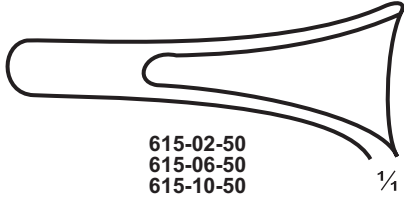

615-02-50
615-06-50
615-10-50
Fig. 2, 50 mm



615-03-75
615-07-75
615-11-75
Fig. 3, 75 mm

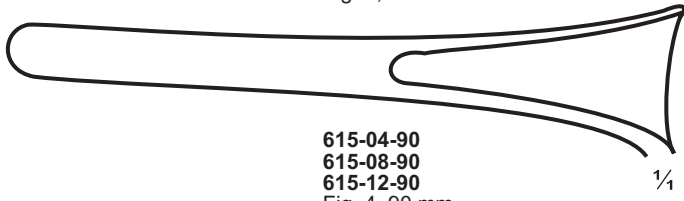

615-04-90
615-08-90
615-12-90
Fig. 4, 90 mm

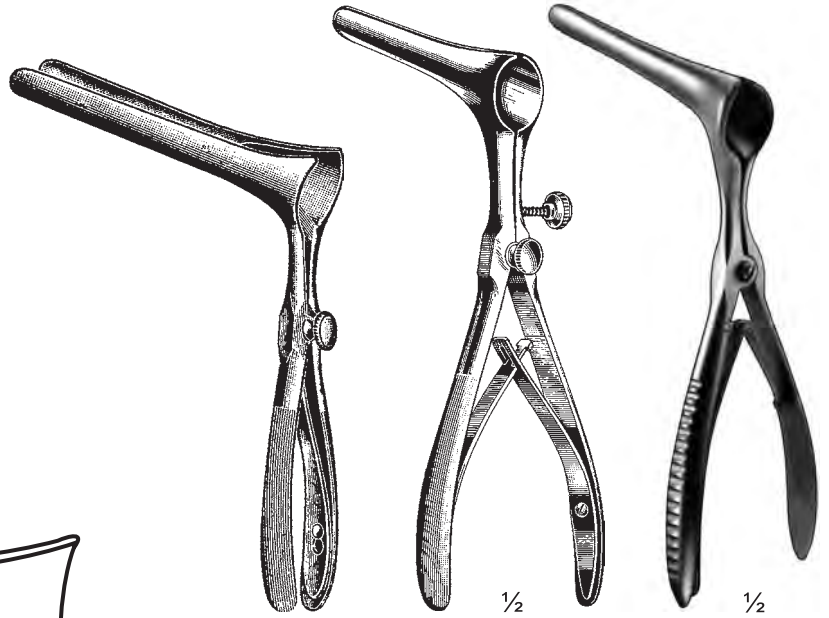

Killian
615-01-35 To 615-04-90
15 cm / 6"

Killian
615-05-35 To 615-08-90
15 cm / 6"

Killian
615-09-35 To 615-12-90
14 cm / 5½"



Cottle
615-13-14 & 615-14-14
14 cm / 5½"
Dull black
chromium plated

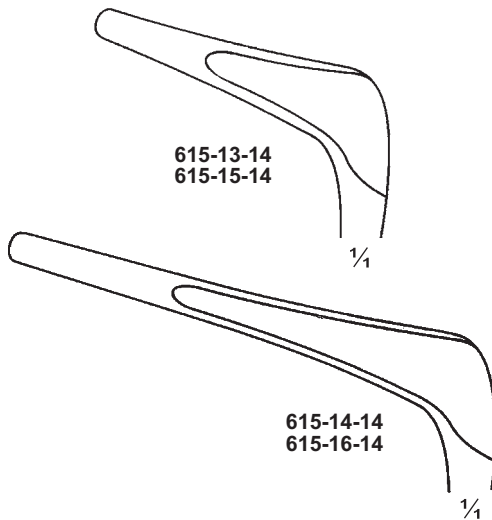

615-13-14
615-15-14

615-14-14
615-16-14

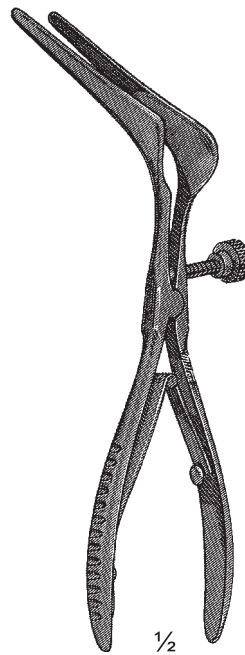

Cottle
615-15-14 & 615-16-14
14 cm / 5½"
Dull black
chromium plated



Yankauer
615-17-19
19 cm / 7½"



Cottle
616-01-15 To 616-04-15
15 cm / 6"

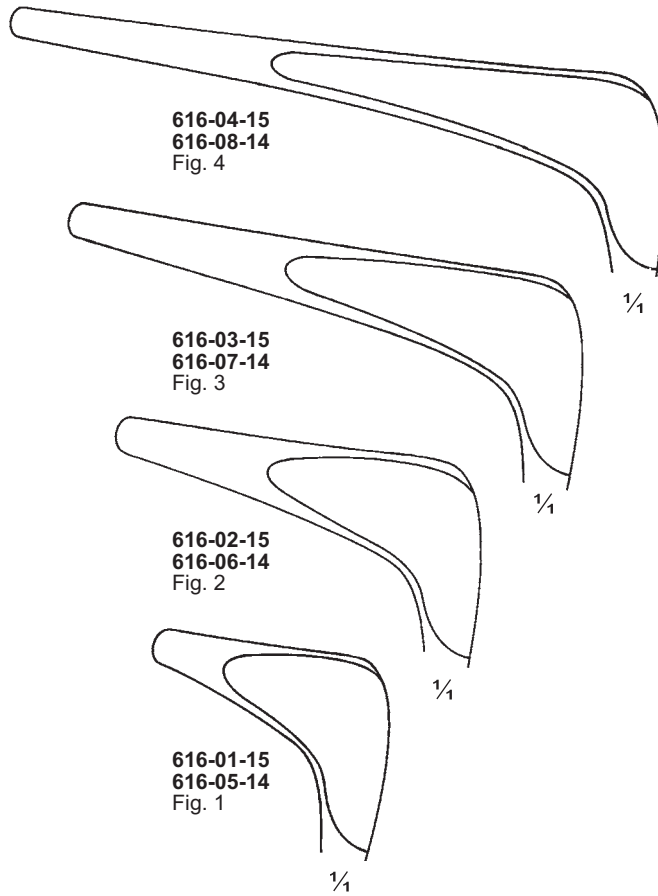

616-04-15
616-08-14
Fig. 4

616-03-15
616-07-14
Fig. 3

616-02-15
616-06-14
Fig. 2

616-01-15
616-05-14
Fig. 1



Cottle
616-05-14 To 616-08-14
14 cm / 5 1/2"



Wiener Model
616-09-15 To 616-11-15
15 cm / 6"

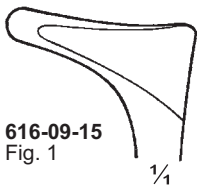

616-09-15
Fig. 1

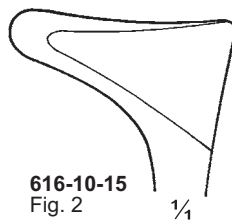

616-10-15
Fig. 2

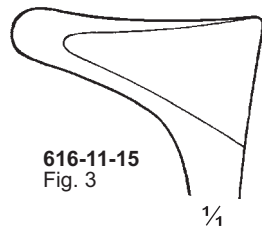

616-11-15
Fig. 3

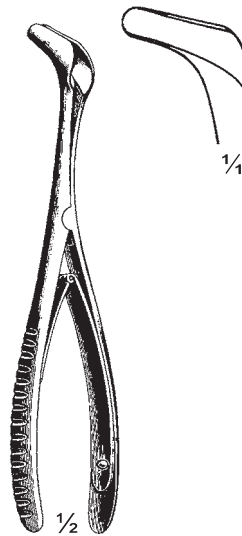

Tieck-Halle
616-12-13
13.5 cm / 5 1/4"

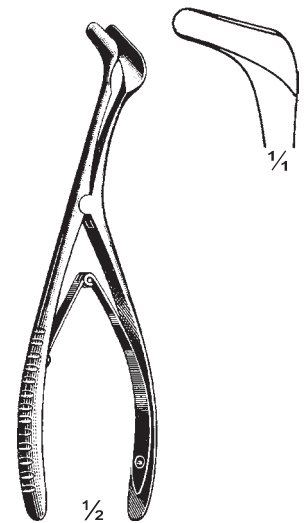

Tieck-Halle
616-13-13
13.5 cm / 5 1/4"

Nasenspekula
Nasal Speculam
Spéculums nasaux

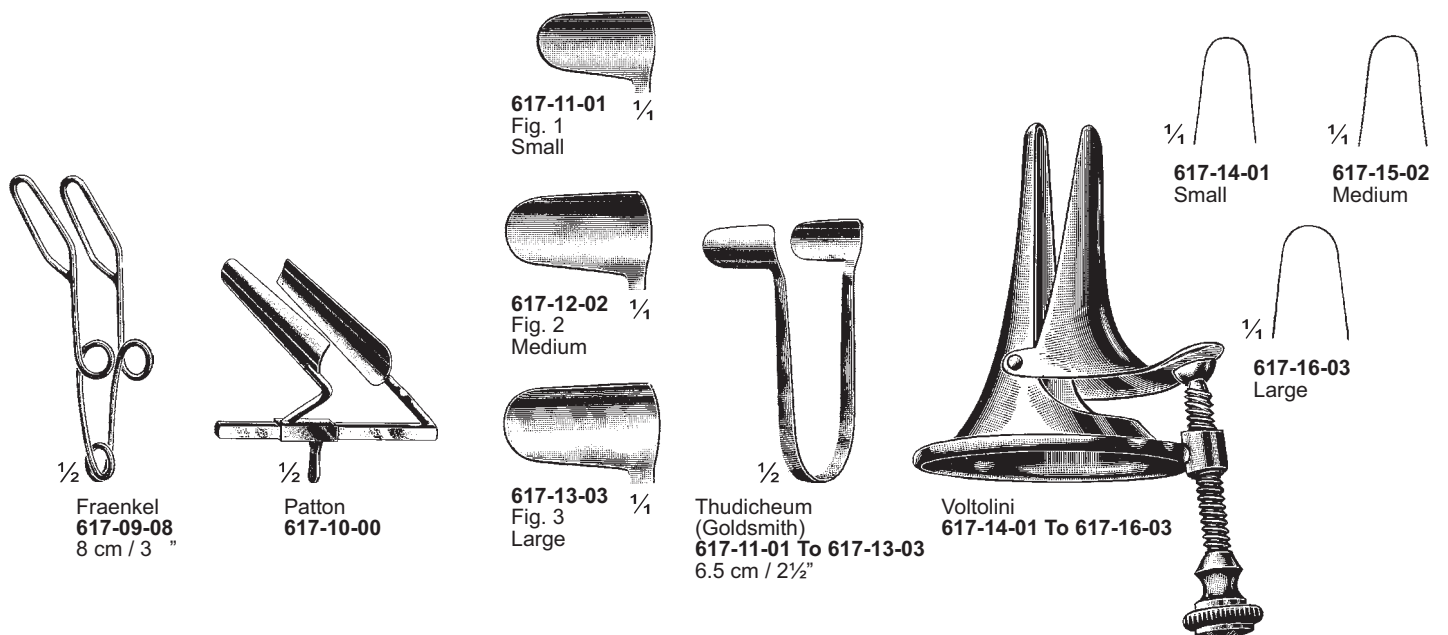
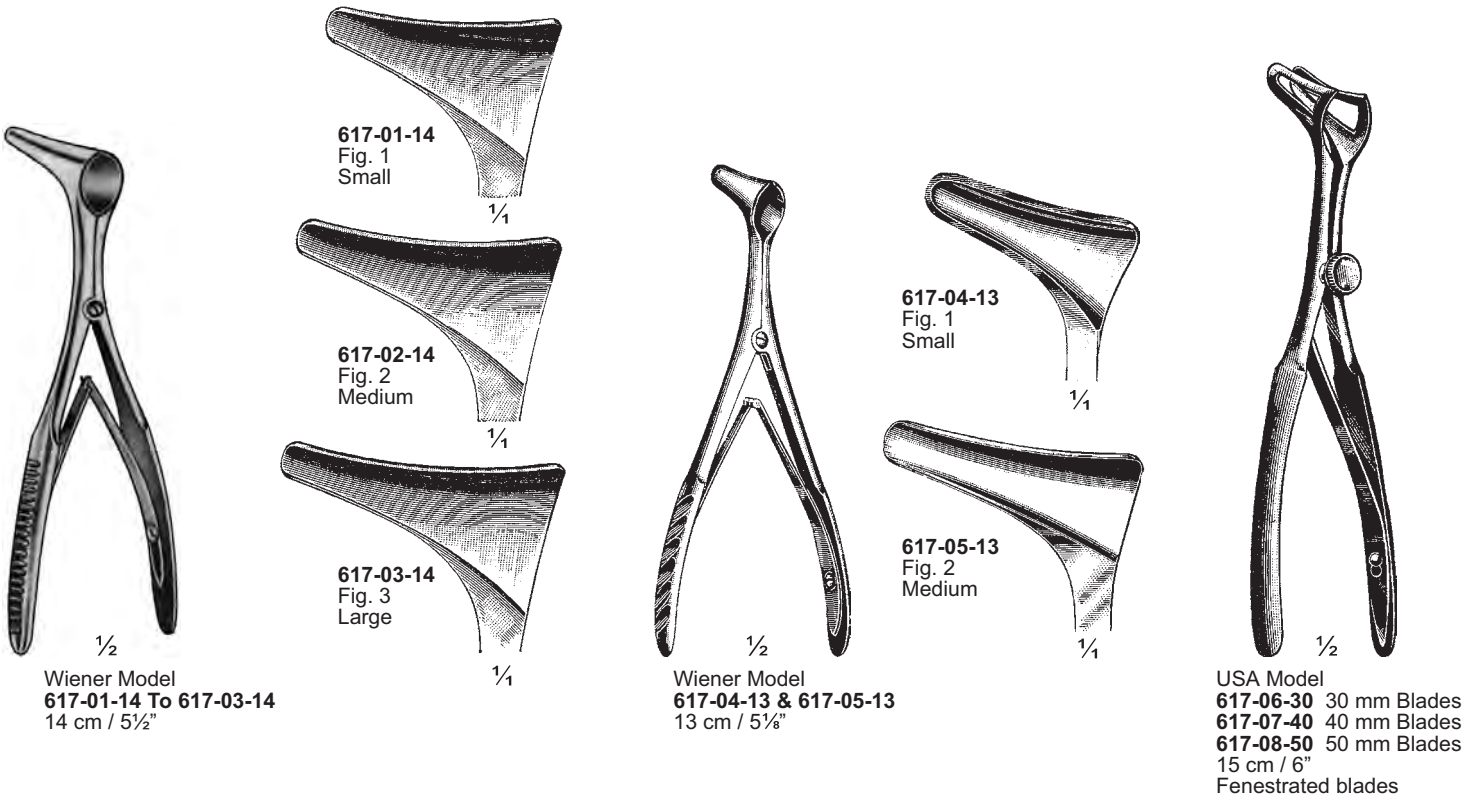

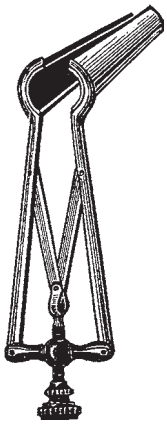

Fraenkel
618-01-00

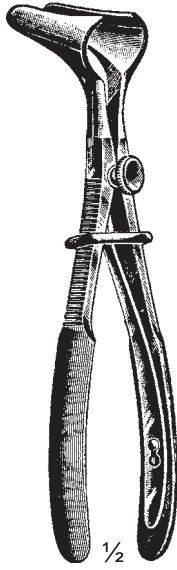

Cholewa
618-02-15
15 cm / 6"



Lange-Wilde
618-03-26
26 cm / 10¼"



Krause
618-04-26
26 cm / 10¼"



Krause-Voss
618-05-26
26 cm / 10¼"

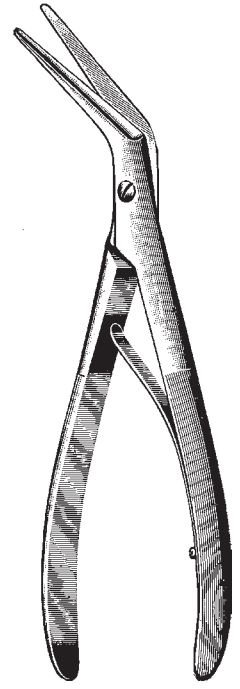

Jackson
618-06-22
22 cm / 8¾"

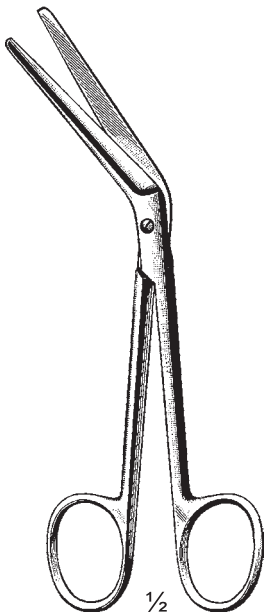

Seiler
618-07-16
16 cm / 6¼"

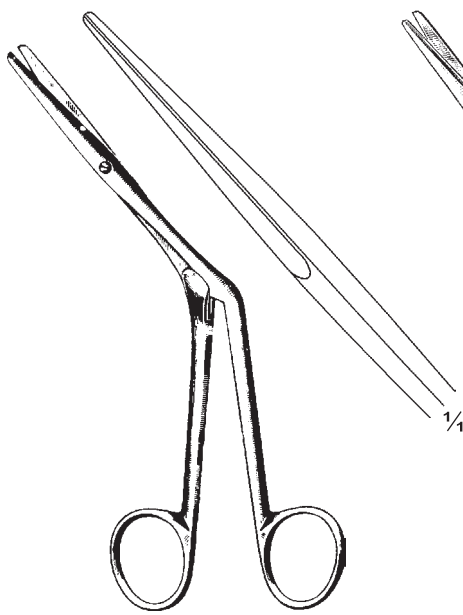

Knight
618-08-18
18 cm / 7"

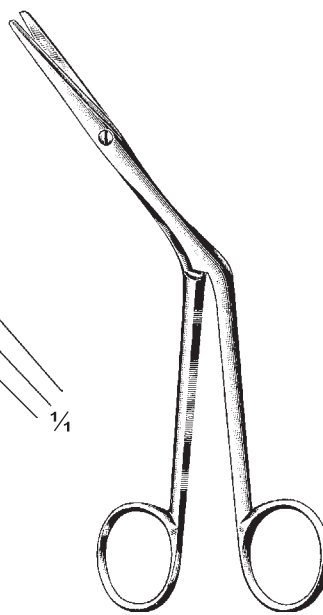

Heymann
618-09-18
18 cm / 7"

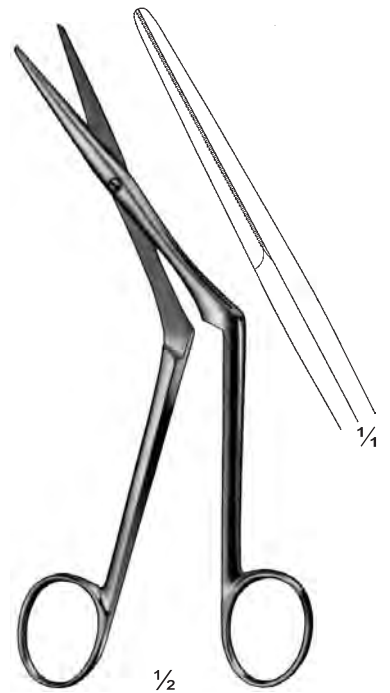

Kirstein
618-10-18
18 cm / 7"

Nasenpolypenzangen
Nasal Polypus Forceps
Pinces à polypes nasaux

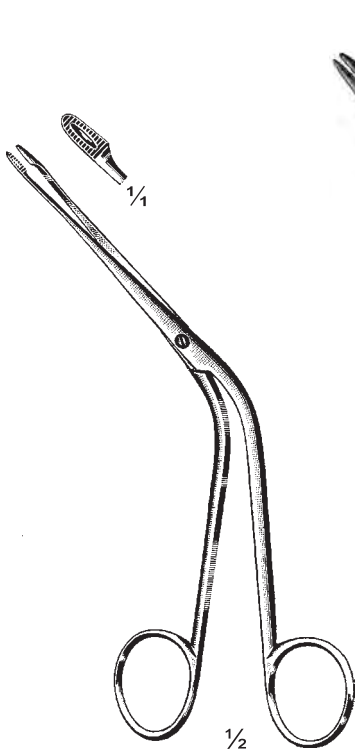

Hartmann
619-01-16
 16 cm / 6¼"

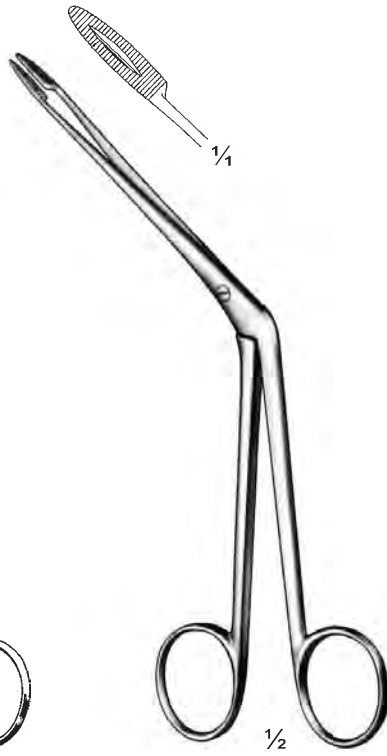

Hartmann
619-02-20
 20 cm / 8"

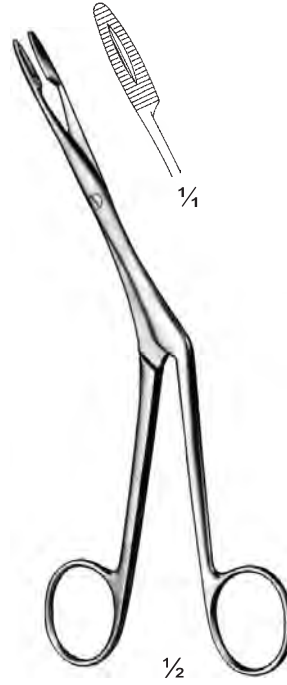

Heymann-Knight
619-03-18
 18 cm / 7"

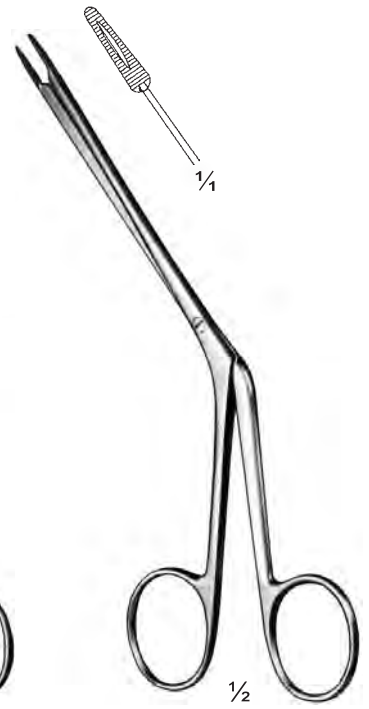

Littauer
619-04-18
 18 cm / 7"

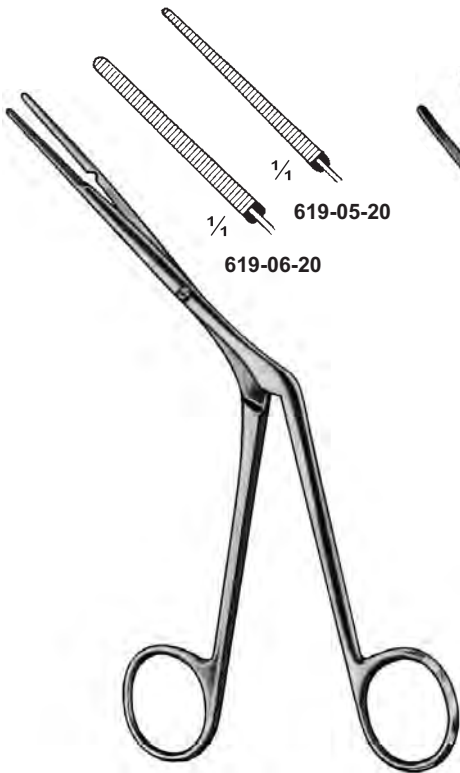

Westmacott
619-05-20 & 619-06-20
 20 cm / 8"

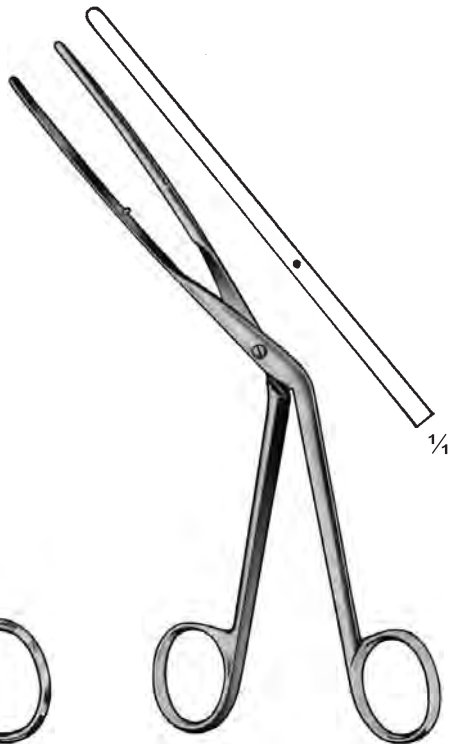

Lubet-Barbon
619-07-20
 20 cm / 8"

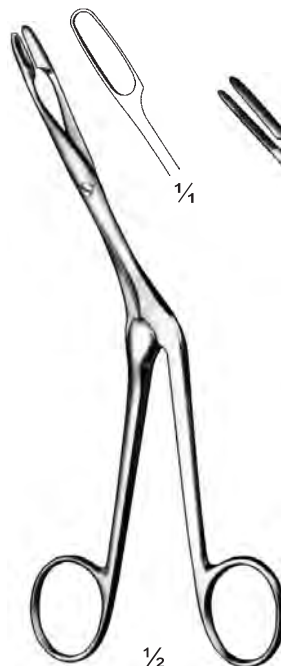

Knight
619-08-18
 18 cm / 7"



Killian
619-09-17
 17 cm / 6¾"

Nasenpolypenzangen Nasal Polypus Forceps Pincès à polypes nasaux

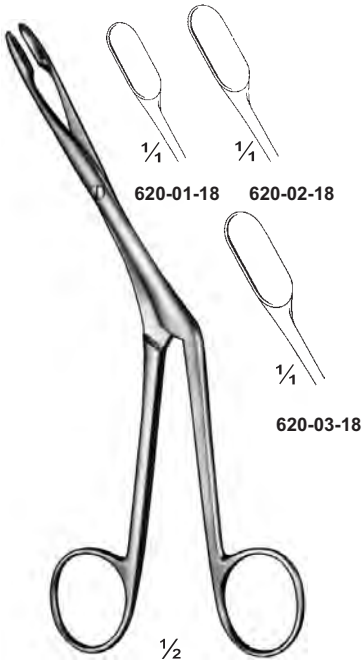

Heymann
620-01-18 To 620-03-18
18 cm / 7"

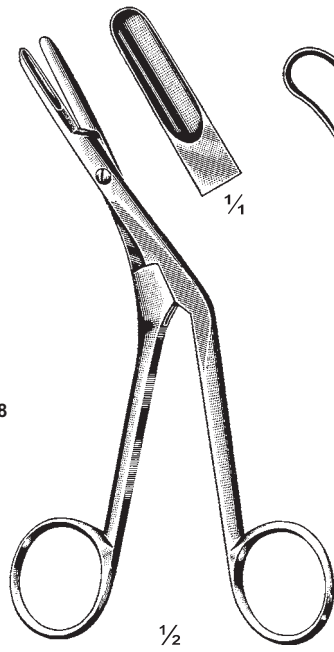

Craig
620-04-18
18 cm / 7"

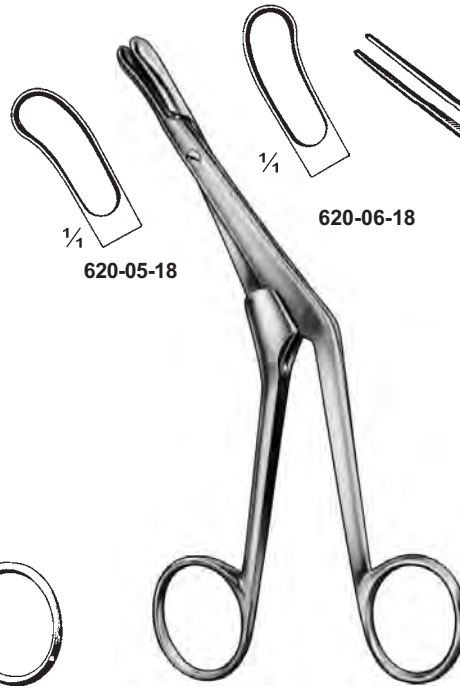

Craig-Domnick
620-05-18 & 620-06-18
18 cm / 7"

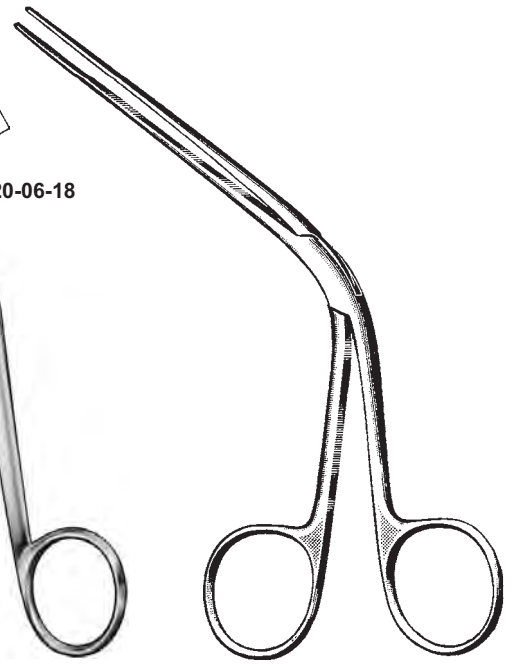

Tilley
620-07-17
17 cm / 6¾"



Quire
620-08-12
12 cm / 4¾"

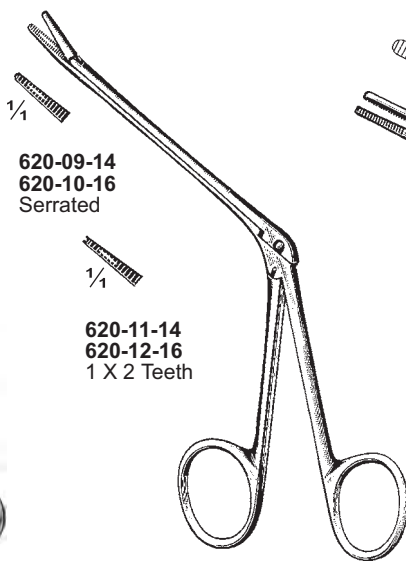

Noyes
Serrated
620-09-14 Shaft 14 cm / 5½" 1 X 2 Teeth
620-10-16 Shaft 16.5 cm / 6½" 620-11-14
620-12-16

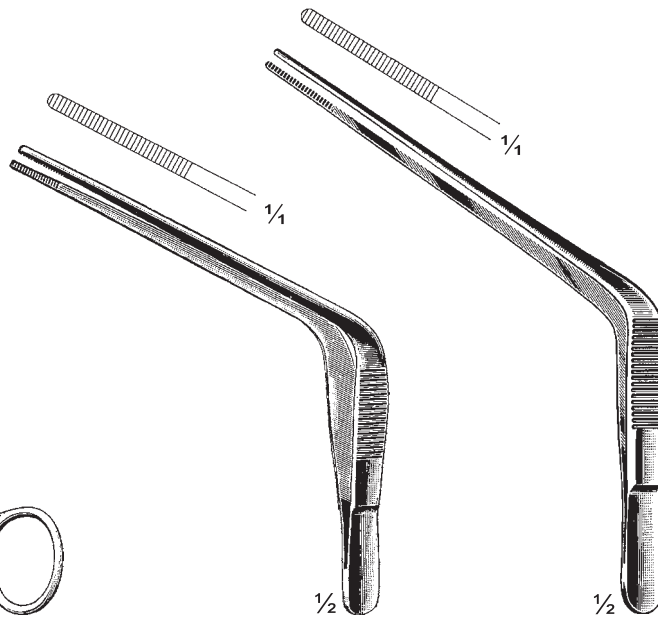

Troeltsch
620-13-15
15 cm / 6"
620-14-18
18 cm / 7"



Gruenwald
(Jansen)
620-15-20
20 cm / 8"

Nasenpolypenzangen
 Nasal Polypus Forceps
 Pincès à polypes nasaux

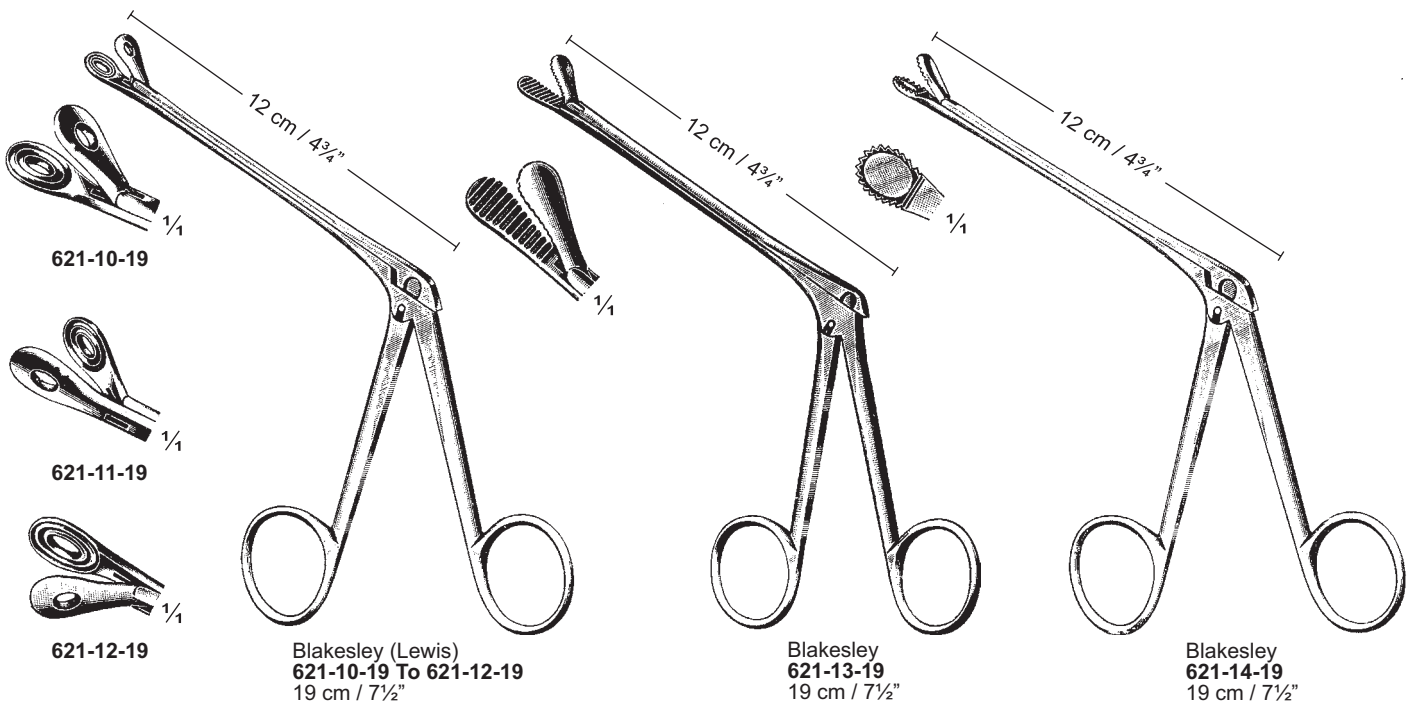
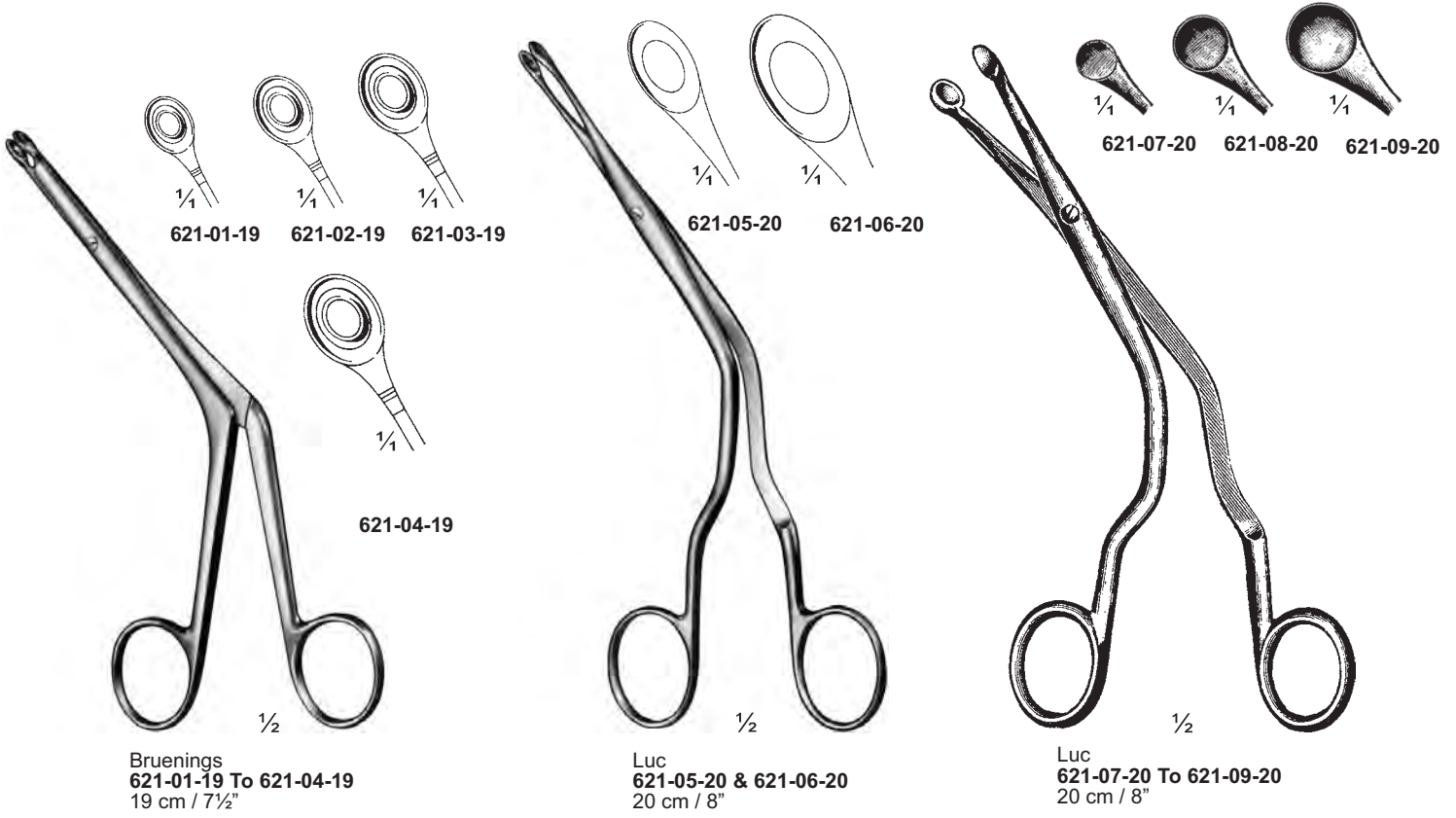

Nasenpolypenzangen Nasal Polypus Forceps Pincès à polypes nasaux

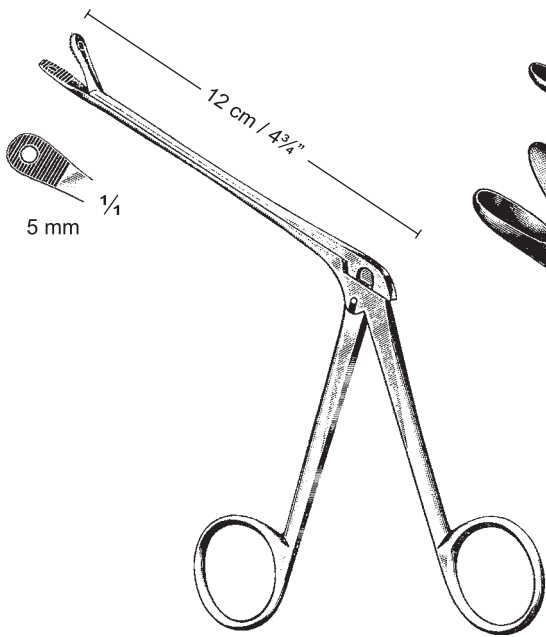

Ferris-Smith
622-01-19
19 cm / 7 1/2"

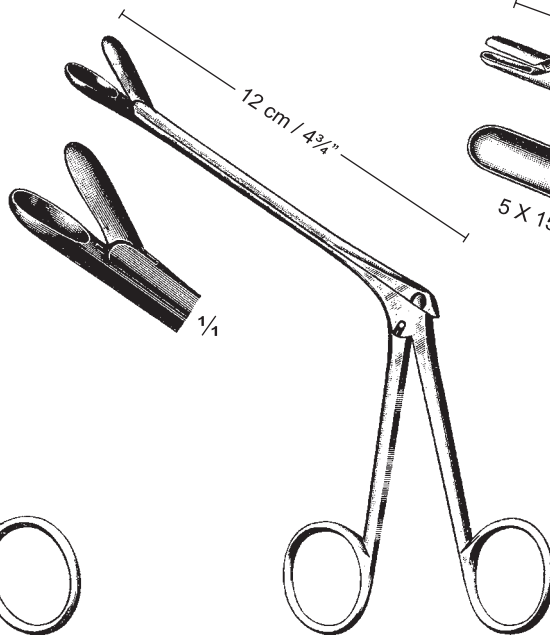

Watson-Williams
622-02-19
19 cm / 7 1/2"

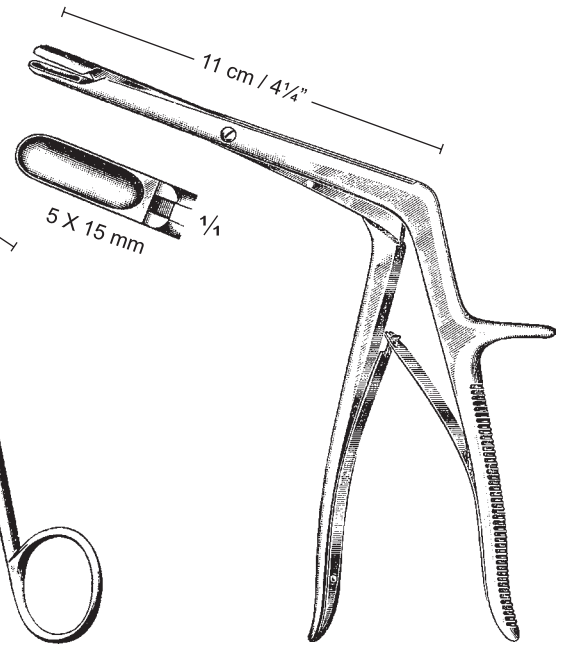

Kofler
622-03-23
23 cm / 9"

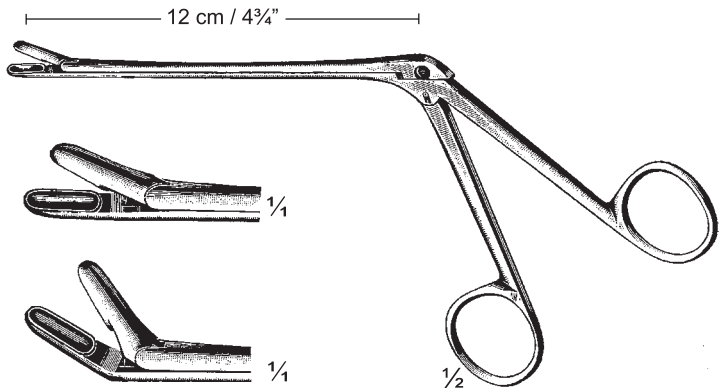
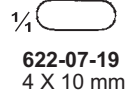
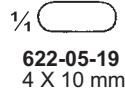
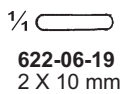
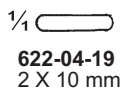

Takahashi
622-04-19 To 623-07-19
19 cm / 7 1/2"

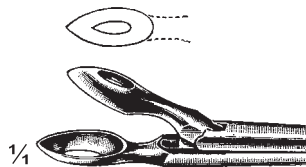

Weil
622-08-19



622-09-19

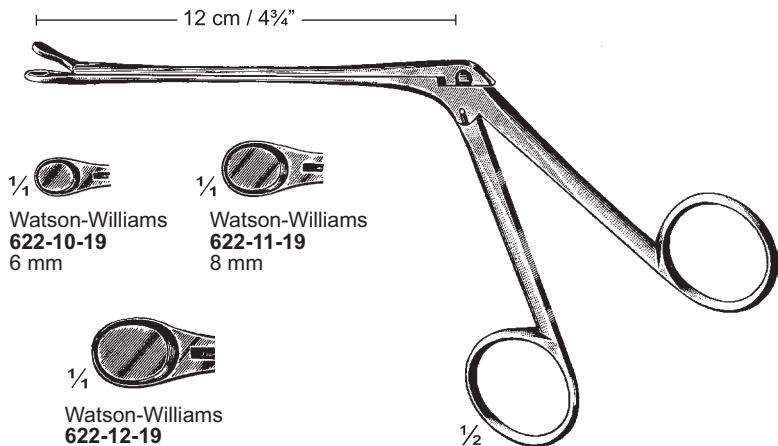

622-08-19 To 622-12-19
19 cm / 7 1/2"

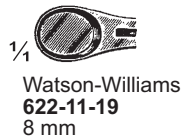
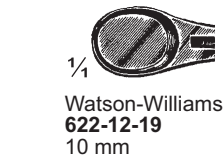
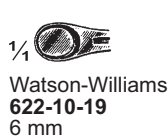

**Siebbeinzangen
Nasal Cutting Forceps
Pincès éthmoïdales**

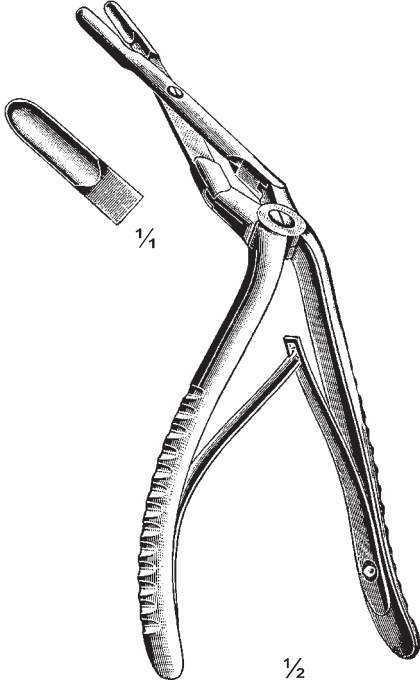

Middleton-Jansen
623-01-19
19 cm / 7½"

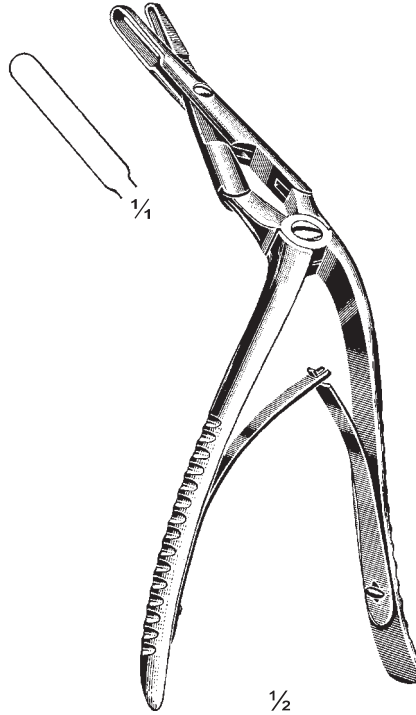

Middleton-Jansen
623-02-19
19 cm / 7½"

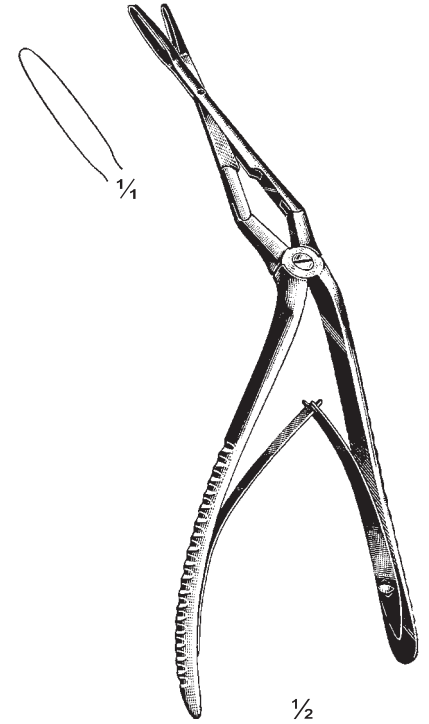

Middleton-Struycken
623-03-19
19 cm / 7½"

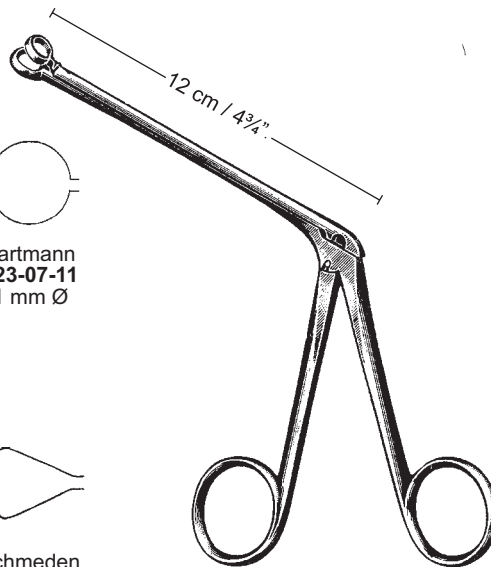
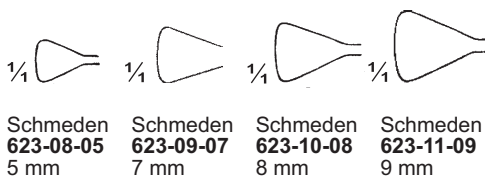
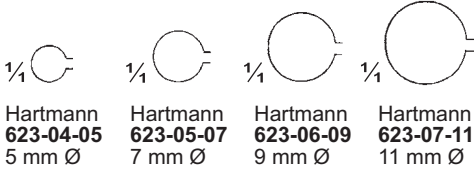

623-04-05 To 623-11-09
19 cm / 7½"



Hajek-Claus
623-12-20
20 cm / 8"

Siebbeinzangen Nasal Cutting Forceps Pincés éthmoidales

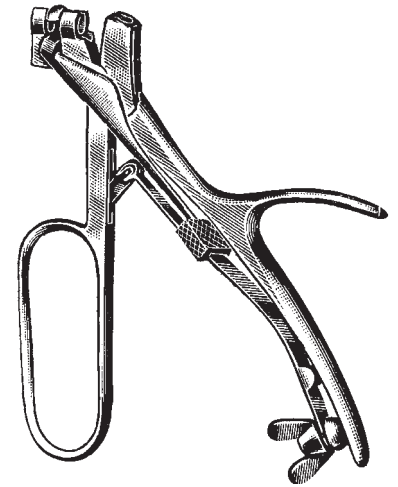
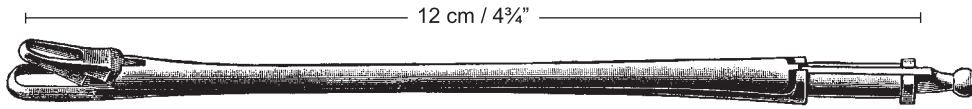

624-01-04 To 624-17-11
Complete handle with
interchangeable shaft



1/4 **Hartmann**
624-01-04
4 X 8 mm

1/4 **Hartmann**
624-02-06
6 X 10 mm

1/4 **Hartmann**
624-03-06
6 X 14 mm

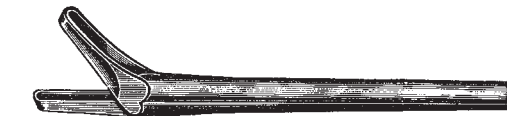

1/4 **Gruenwald**
624-04-02
2 X 11 mm



Cordes
624-05-03
3 mm



Cordes
624-06-03
3 mm

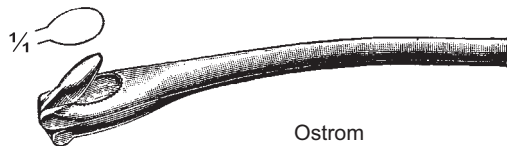

Ostrom
624-07-00

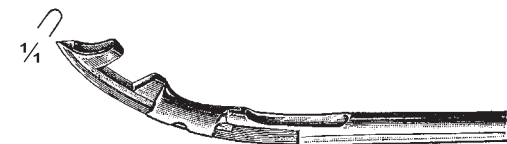

Wagener
624-08-00

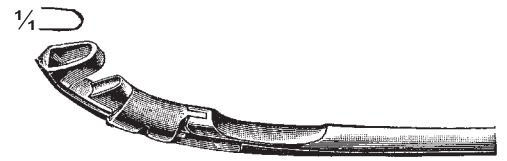

Wagener
624-09-00



Wagener
624-10-00



1/4 **Myles**
624-11-02
2.5 X 7 mm

1/4 **Myles**
624-12-03
3 X 8 mm

1/4 **Myles**
624-13-03
3.5 X 9 mm



1/4 **Hartmann**
624-14-05
5 mm Ø

1/4 **Hartmann**
624-15-07
7 mm Ø

1/4 **Hartmann**
624-16-09
9 mm Ø

1/4 **Hartmann**
624-17-11
11 mm Ø

Septummesser Septum Knives Bistouris pour la cloison nasale



Cottle
625-01-15
15 cm / 6"



Cottle
625-02-15
15 cm / 6"



Heymann
625-03-14
14 cm / 5½"



Fomon
625-04-16
16 cm / 6¼"



Joseph
625-05-15
15 cm / 6"



Converse
625-06-16
16 cm / 6¼"

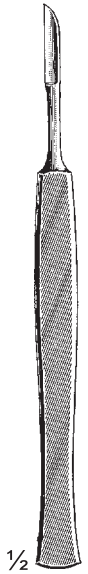

Krieg
625-07-15
15 cm / 6"



Joseph
625-08-16
16 cm / 6¼"



Joseph
625-09-21
21 cm / 8¼"



Joseph
625-10-16 To 625-17-16
16 cm / 6¼"



625-10-16
Sharp

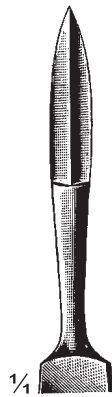

625-11-16
Sharp

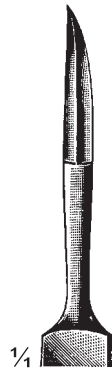

625-12-16
Sharp

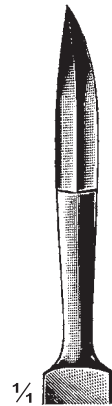

625-13-16
Sharp

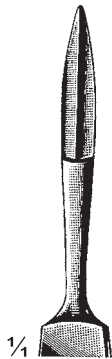

625-14-16
Blunt

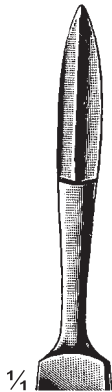

625-15-16
Blunt

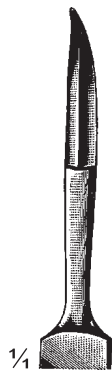

625-16-16
Blunt



625-17-16
Blunt

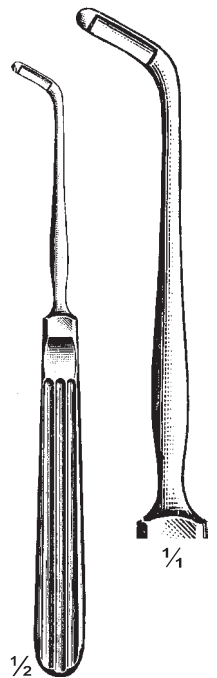

Joseph
625-18-16
16 cm / 6¼"

Septummesser
Septum Knives
Bistouris pour la cloison nasale

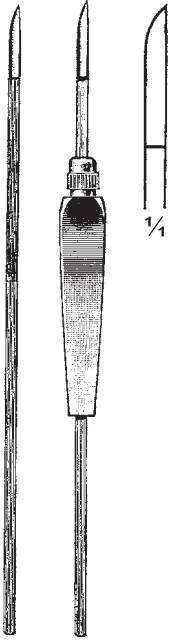

Bruenings
626-01-16
16 cm / 6¼"

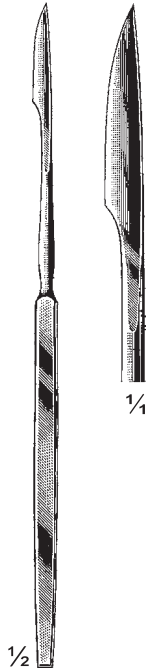

Halle
626-02-18
18 cm / 7"

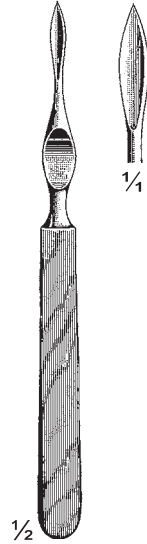

Ballenger
626-03-14
14 cm / 5½"



Freer
626-04-15
15 cm / 6"



Freer
626-05-15
15 cm / 6"

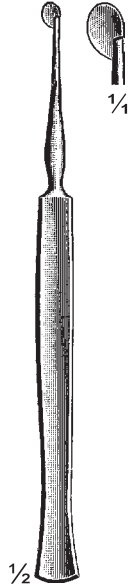

Freer
626-06-16
16 cm / 6¼"

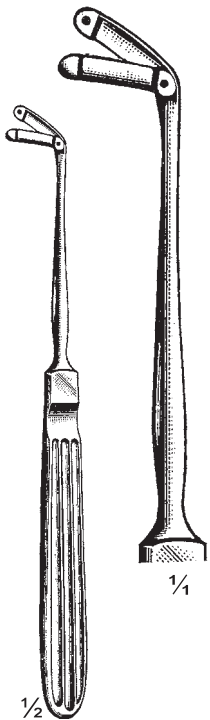

Maltz
626-07-16
16 cm / 6¼"

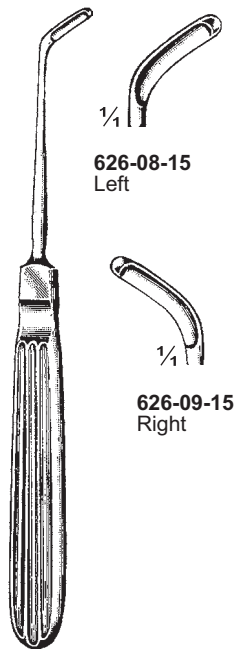

626-08-15 & 626-09-15
15 cm / 6"

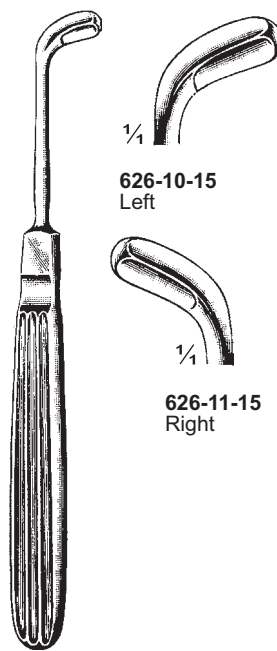

626-10-15 & 626-11-15
15 cm / 6"

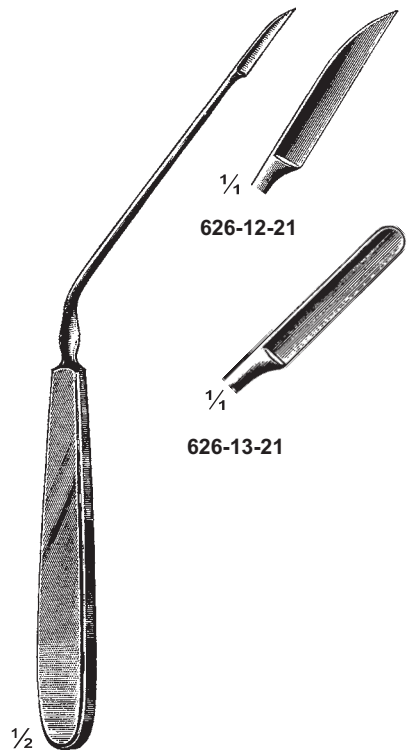

Flatau
626-12-21 & 626-13-21
21 cm / 8¼"

**Septummesser
Septum Knives
Bistouris pour la cloison nasale**

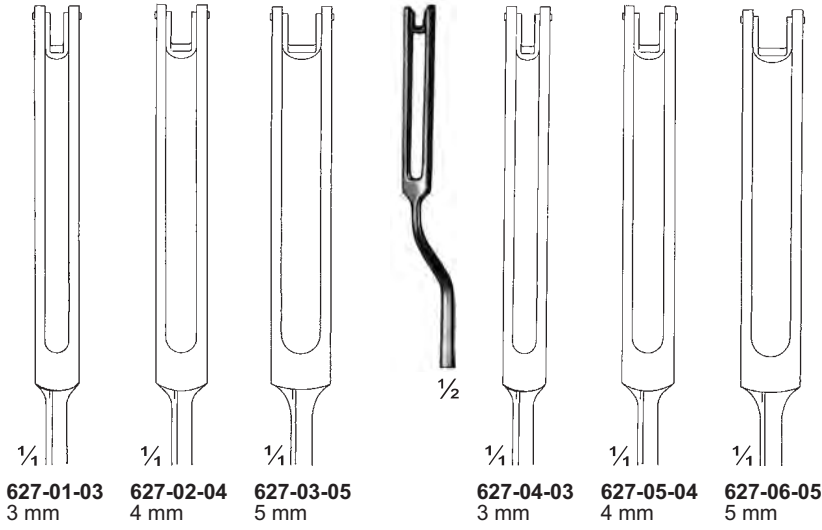

Killian
627-07-13
13 cm / 5 1/8"



1/2
Freer-Ingals
627-08-17
17 cm / 6 3/4"

Ballenger
627-01-03 To 627-06-05
20 cm / 8"

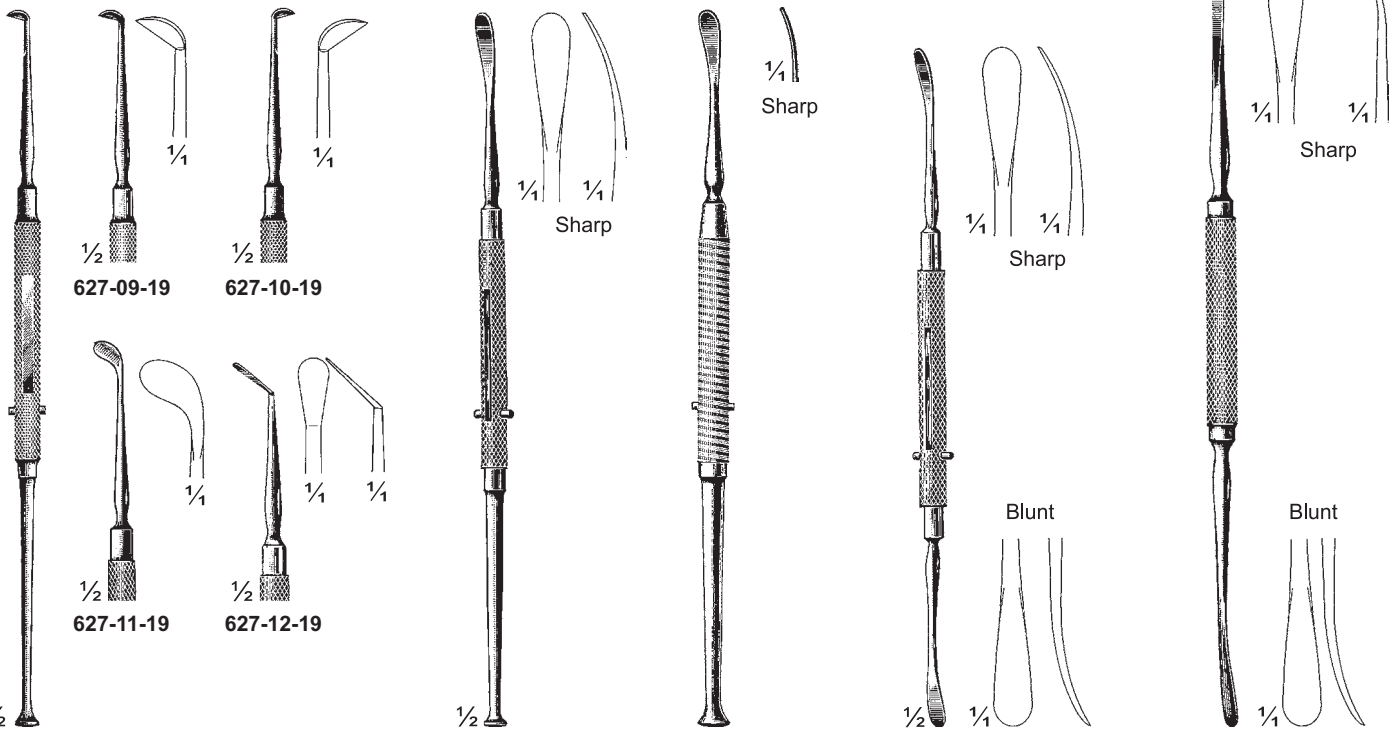

Freer
627-09-19 To 627-12-19
19 cm / 7 1/2"

Freer
627-13-19
19 cm / 7 1/2"

Freer
627-14-19
19 cm / 7 1/2"

Freer
627-15-18
18 cm / 7"

Freer
627-16-20
20 cm / 8"

Septum elevatorien Septum Elevators Élévateurs pour la cloison nasale

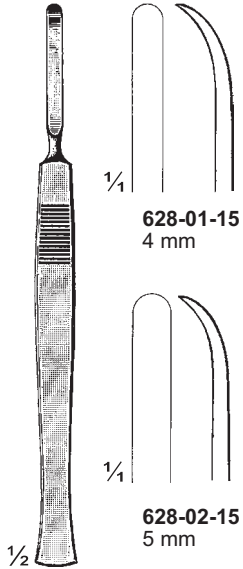

McKenty
628-01-15 & 628-02-15
15 cm / 6"

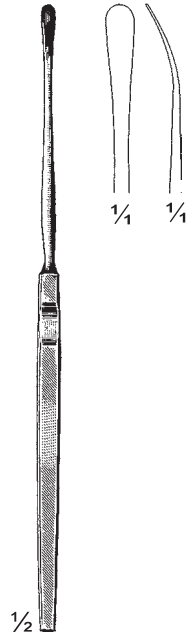

Halle
628-03-16
16.5 cm / 6½"

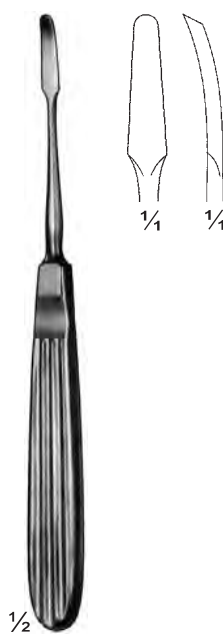

Joseph
628-04-16
16 cm / 6¼"

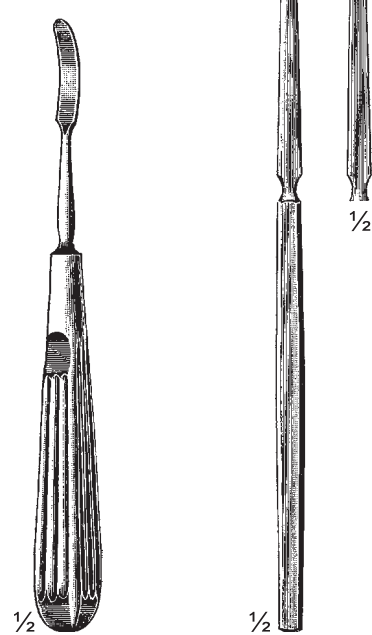

Joseph
628-05-16
16 cm / 6¼"

Killian
628-06-17
17 cm / 6¾"
Sharp

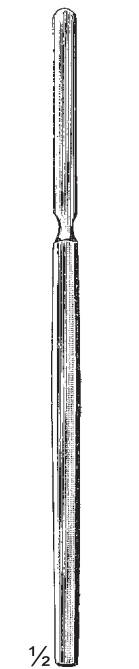

Killian
628-07-17
17 cm / 6¾"
Blunt

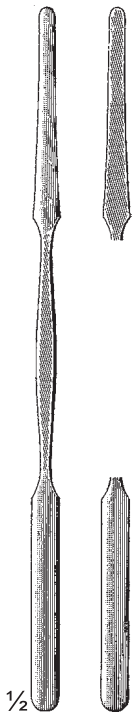

Killian
628-08-18
18 cm / 7"

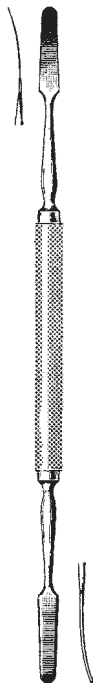

Killian
628-09-18
18 cm / 7"

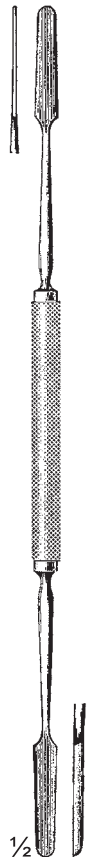

Killian
628-10-23
23 cm / 9"



Hajek-Ballenger
628-11-20
20 cm / 8"

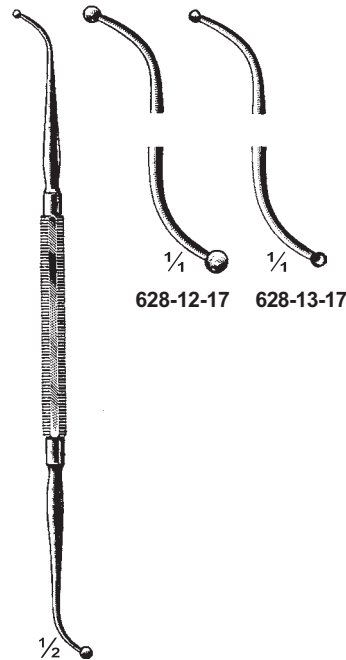

Kistner
628-12-17 & 628-13-17
17 cm / 6¾"



Pierce
628-14-20
20 cm / 8"

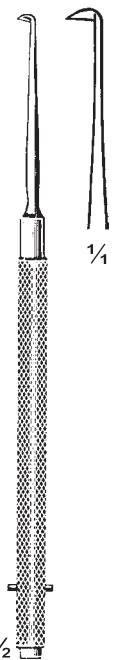

Freer-Ingals
628-15-17
17 cm / 6¾"

**Septum elevatorien
Septum Elevators
Élévateurs pour la cloison nasale**

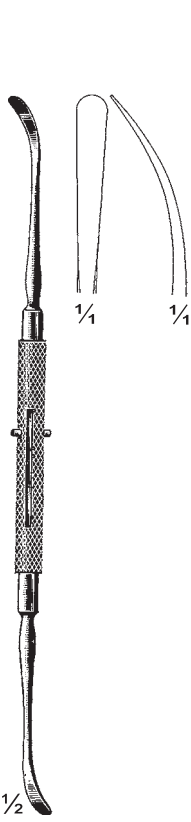

$\frac{1}{2}$
Roger
629-01-19
19 cm / 7½"

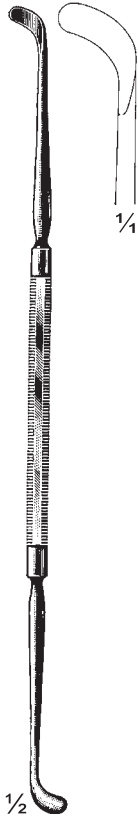

$\frac{1}{2}$
Pennington
629-02-21
21 cm / 8¼"

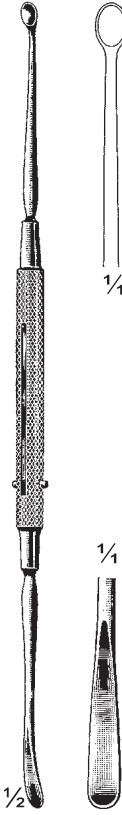

$\frac{1}{2}$
Carter
629-03-21
21 cm / 8¼"



$\frac{1}{2}$
Howarth
629-04-21
21.5 cm / 8½"



$\frac{1}{2}$
McKenty
629-05-22
22 cm / 8¾"

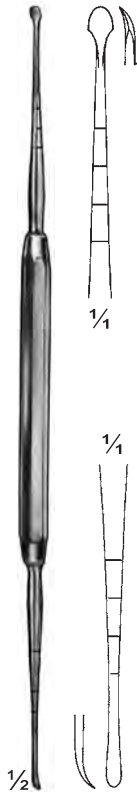

$\frac{1}{2}$
Masing
629-06-21
21 cm / 8¼"

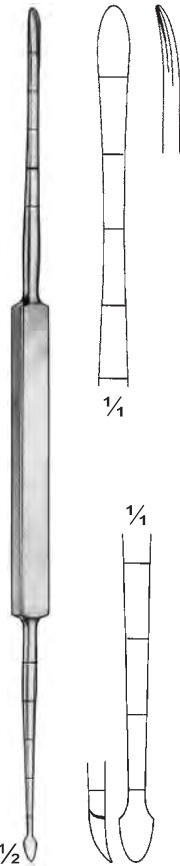

$\frac{1}{2}$
Cottle
629-07-21
21 cm / 8¼"

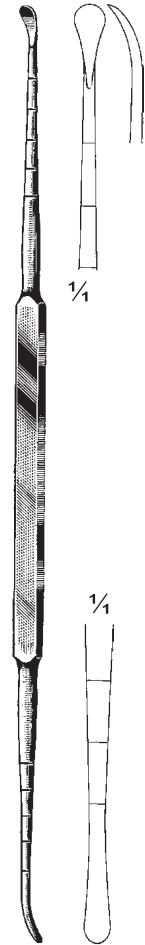

$\frac{1}{4}$
Cottle
629-08-22
22 cm / 8¾"

Septum elevatorien
Septum Elevators
Élévateurs pour la cloison nasale

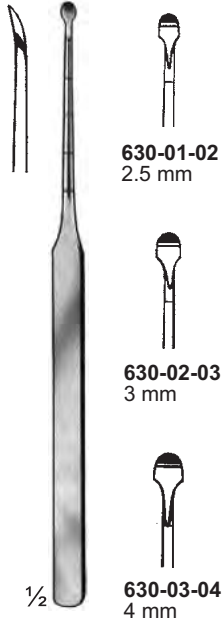

Cottle
630-01-02 To 630-03-04
 16 cm / 6¼"



Cottle
630-04-23
 23 cm / 9"



Joseph-Masing
630-05-22
 22 cm / 8¾"



Large
630-06-23
 23 cm / 9"

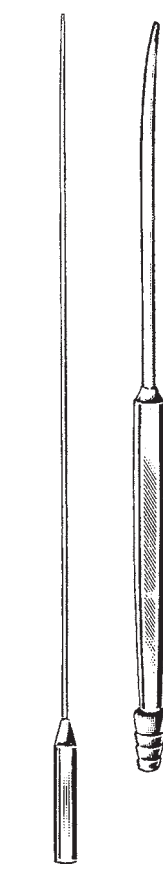

630-07-21
 21 cm / 8¼"
 4 mm Ø

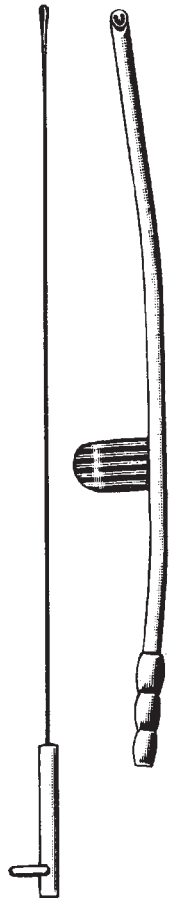

630-08-20
 20 cm / 8"
 4 mm

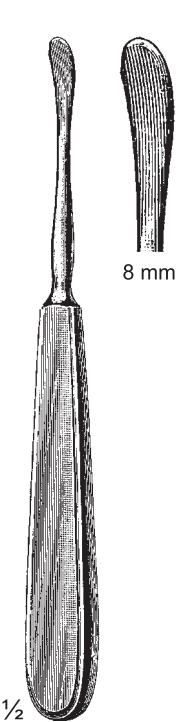

Yankauer
630-09-18
 18 cm / 7"



630-10-18
 Sharp

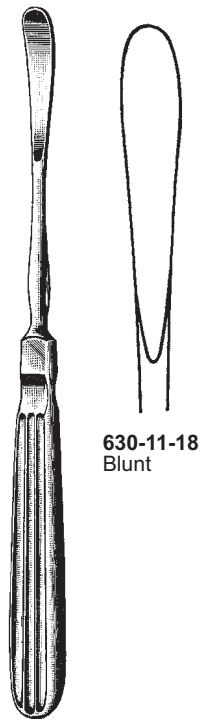

630-11-18
 Blunt



Converse
630-12-18
 18 cm / 7"

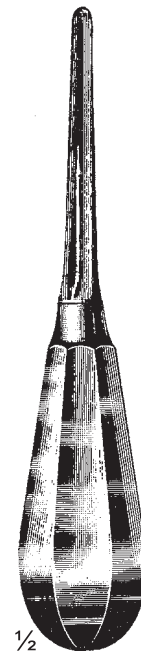

Goldman
630-13-17
 17 cm / 6¾"

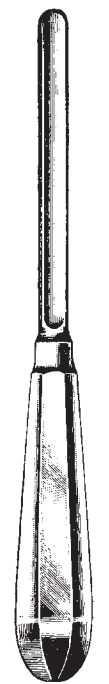

Converse
630-14-19
 19 cm / 7¾"

Septumelevatorien Septum Elevators Élévateurs pour la cloison nasale

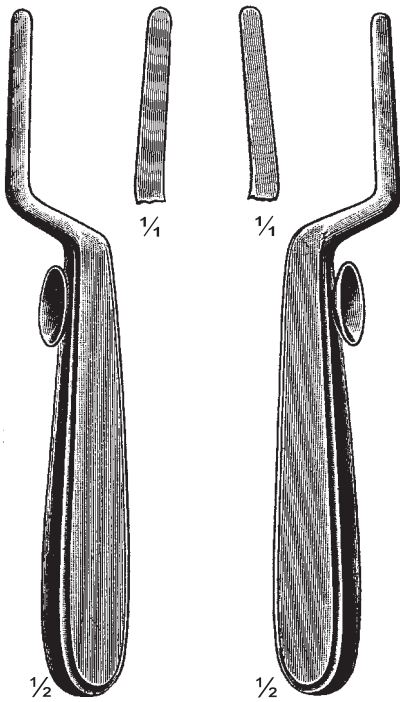

1/2
Killian
631-01-18
18 cm / 7"
Left

1/2
Killian
631-02-18
18 cm / 7"
Right



631-03-22
22 cm / 8 3/4"



1/2
Cottle
631-04-22
22 cm / 8 3/4"



1/2
Cottle
631-05-23
23 cm / 9"

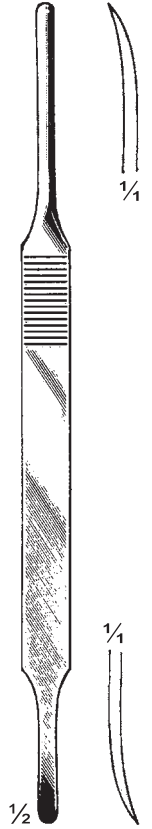

1/2
Cottle-McKenty
631-06-22
22 cm / 8 3/4"

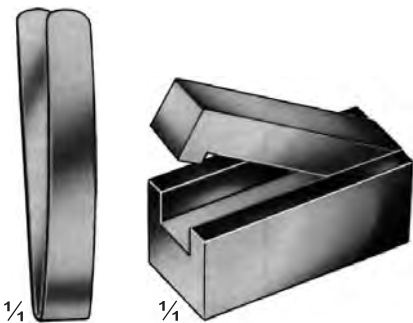

1/4
Cottle
631-07-00
Bone crusher



1/4
Cottle
631-08-00
Bone and cartilage
guide



1/4
631-09-00
Bone and cartilage
guide

**Tonsillenscheren
Septum Scissors
Ciseaux pour les amygdales**



Cottle
632-01-19
19 cm / 7 $\frac{3}{4}$ "

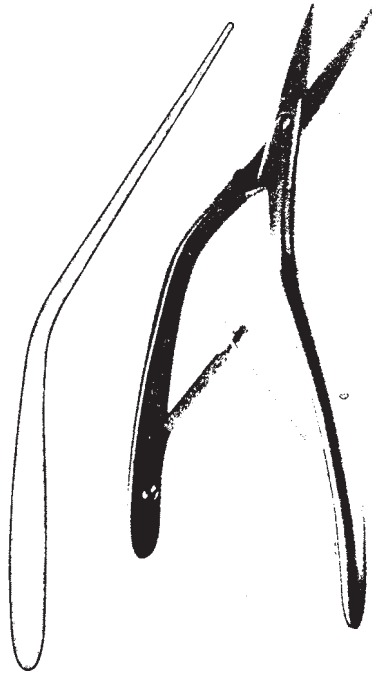

Cottle
632-02-19
19 cm / 7 $\frac{3}{4}$ "



Muhling
632-03-21
21 cm / 8 $\frac{1}{4}$ "

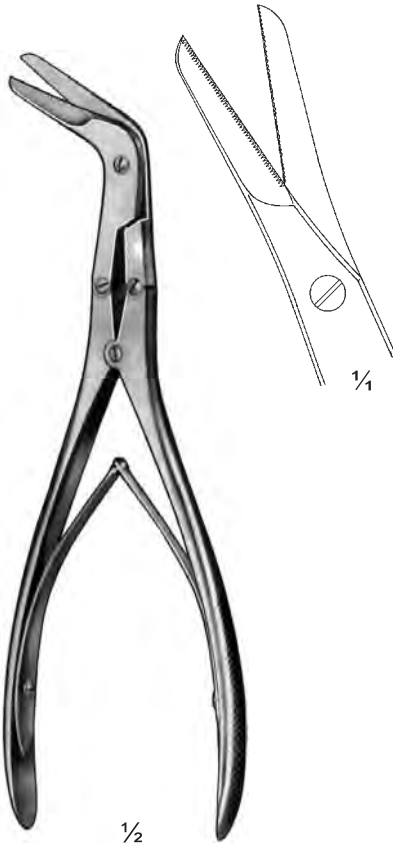

Killian
632-04-21
21 cm / 8 $\frac{1}{4}$ "
Both blades serrated

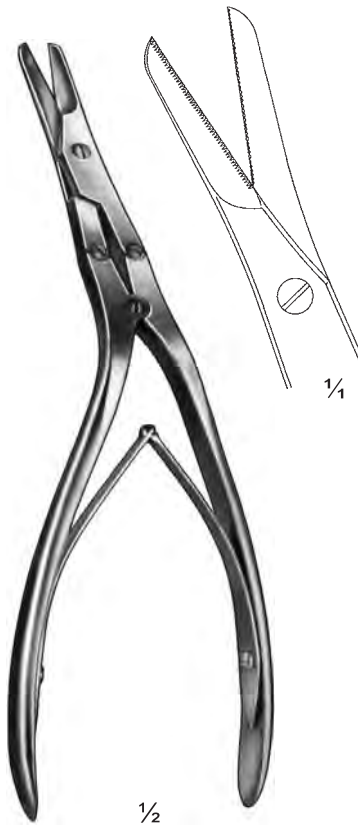

Caplan
632-05-20
20 cm / 8"
Both blades serrated



Ruhin
632-06-21
21 cm / 8 $\frac{1}{4}$ "
Septum morselizer

Nasenmeißel, Osteotome, Nasensägen
Rhinoplastic Chisels, Osteotomes, Nasal Saws
Ciseaux-burins nasaux, Ostéotomes, Scies nasales



Freer
633-01-16
 16 cm / 6¼"

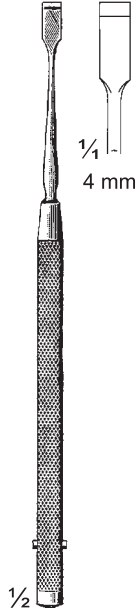

Freer
633-02-16
 16 cm / 6¼"



Freer
633-03-17 4 mm
633-04-17 6 mm
 17 cm / 6¾"



Ballenger
633-05-17 4 mm
633-06-17 6 mm
 17 cm / 6¾"



Killian
633-07-16
 16 cm / 6¼"

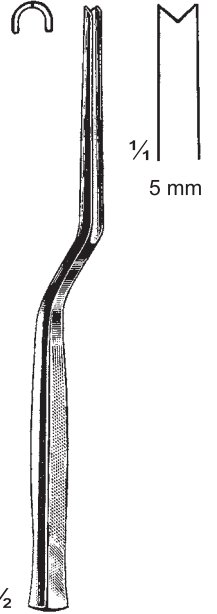

Killian-Claus
633-08-16
 16 cm / 6¼"

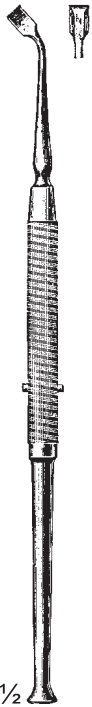

Freer
633-09-19 & 633-10-19
 19 cm / 7½"



Sewall
633-11-20
 20 cm / 8"



Rubin
633-12-10 To 633-14-14
 18 cm / 7"

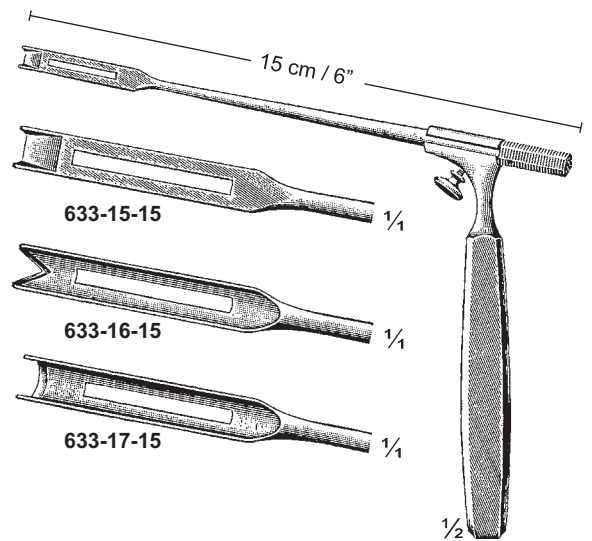
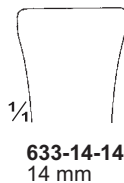
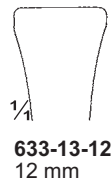
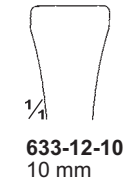

Metzenbaum
633-15-15 To 633-17-15
 Handle size 11 cm / 4¼"
633-18-00
 Complete with 1 Handle
 1 Chisel and 2 Gouges

Nasenmeißel, Osteotome, Nasensägen

Rhinoplastic Chisels, Osteotomes, Nasal Saws

Ciseaux-burins nasaux, Ostéotomes, Scies nasales

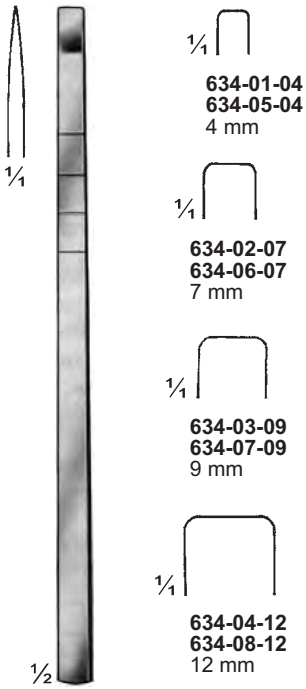

634-01-04
634-05-04
4 mm

634-02-07
634-06-07
7 mm

634-03-09
634-07-09
9 mm

634-04-12
634-08-12
12 mm

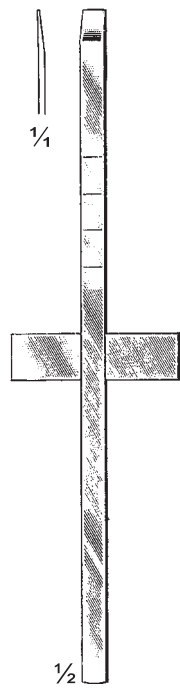

Cottle
634-05-04 To 634-08-12
18 cm / 7"

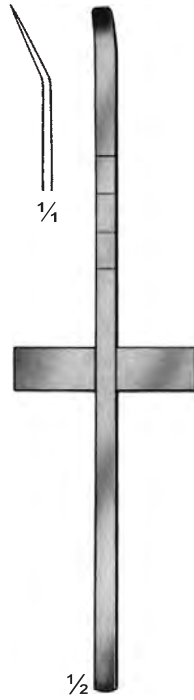

Cottle
634-09-04 To 634-12-12
18 cm / 7"

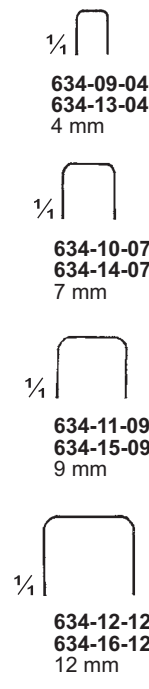

634-09-04
634-13-04
4 mm

634-10-07
634-14-07
7 mm

634-11-09
634-15-09
9 mm

634-12-12
634-16-12
12 mm

Cottle
634-13-04 To 634-16-12
18 cm / 7"

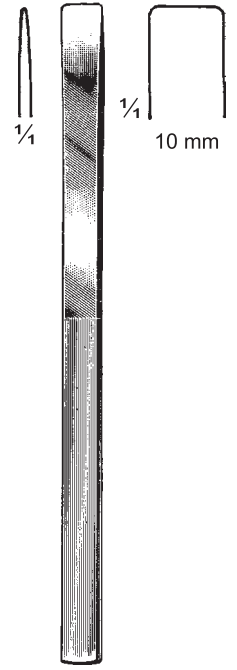

Cottle
634-17-10
20 cm / 8"

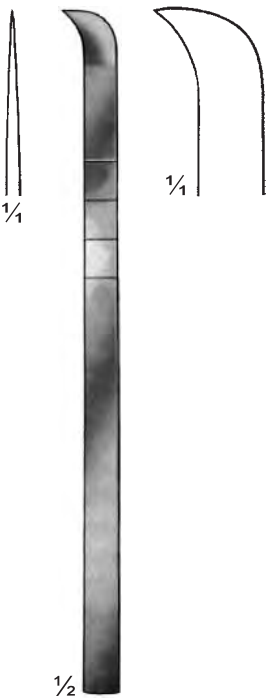

Cottle
634-18-18
18 cm / 7"



Cottle
634-19-04 To 634-22-12
18 cm / 7"



634-19-04
4 mm

634-20-07
7 mm

634-21-09
9 mm

634-22-12
12 mm



634-23-03
3 mm

634-24-05
5 mm

Walter
634-23-03 & 634-24-05
19 cm / 7 1/2"

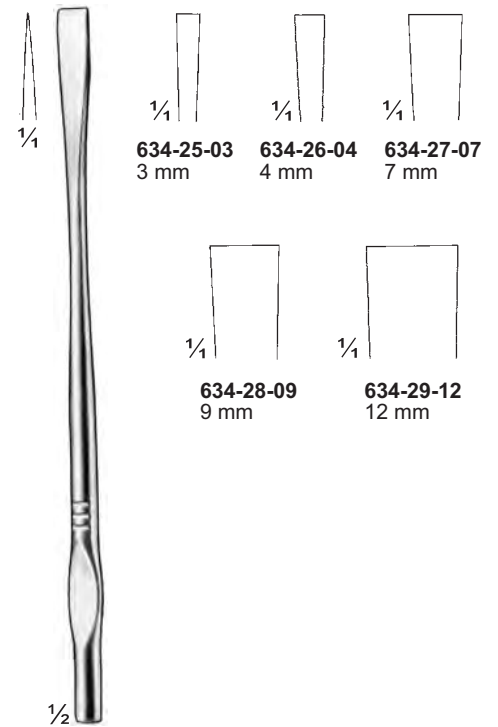

634-25-03
3 mm

634-26-04
4 mm

634-27-07
7 mm

634-28-09
9 mm

634-29-12
12 mm

Walter
634-25-03 To 634-29-12
19 cm / 7 1/2"

Nasenmeißel, Osteotome, Nasensägen
Rhinoplastic Chisels, Osteotomes, Nasal Saws
Ciseaux-burins nasaux, Ostéotomes, Scies nasales

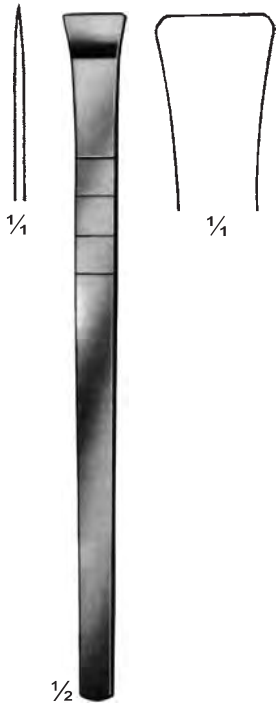

Cottle
635-01-18
 18 cm / 7"

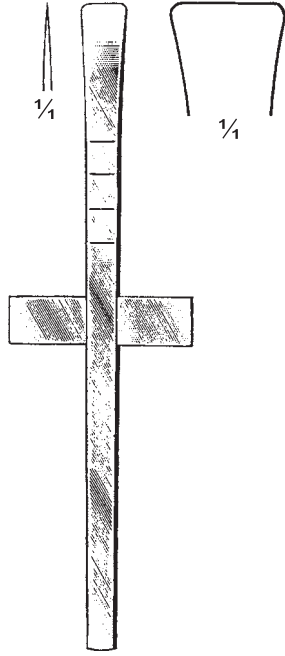

Cottle
635-02-18
 18 cm / 7"

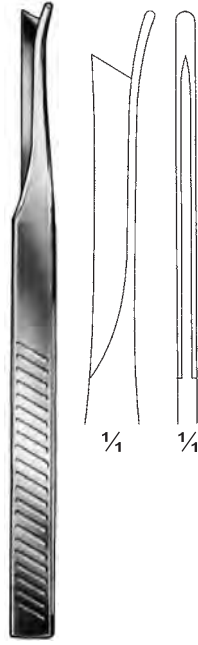

Silver
635-03-18
 18 cm / 7"

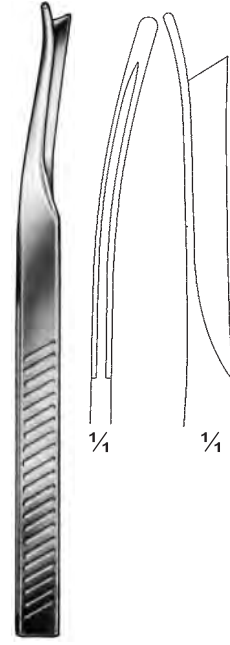

Silver
635-04-18
 18 cm / 7"

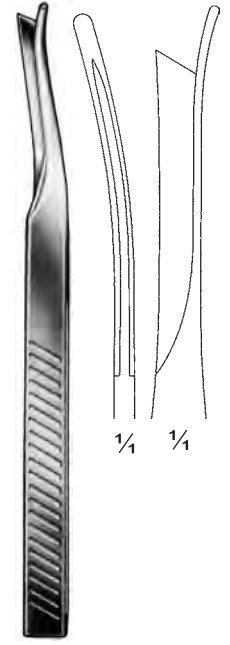

Silver
635-05-18
 18 cm / 7"

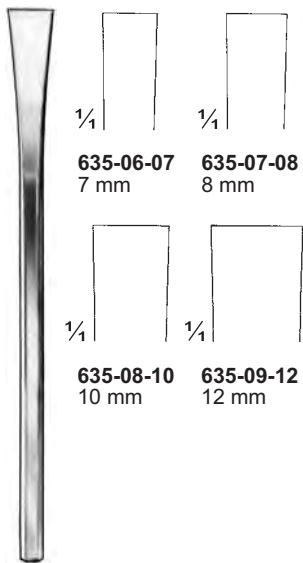

Sheehan
635-06-07 To 635-09-12
 17 cm / 6 3/4"

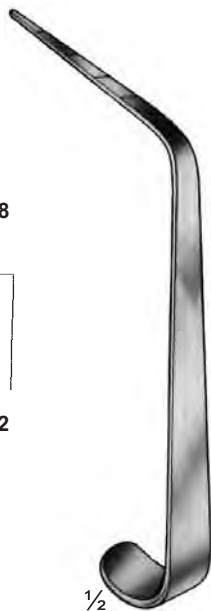

Cottle
635-10-40 To 635-13-70
 16 cm / 6 1/4"

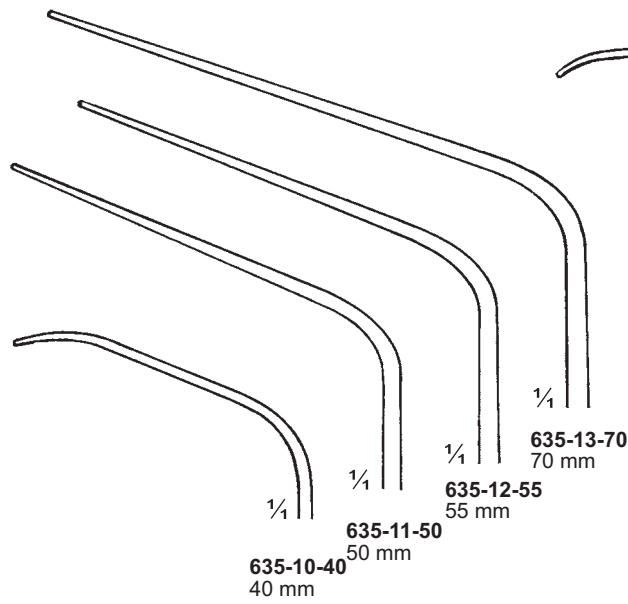

635-10-40
 40 mm

635-11-50
 50 mm

635-12-55
 55 mm

635-13-70
 70 mm

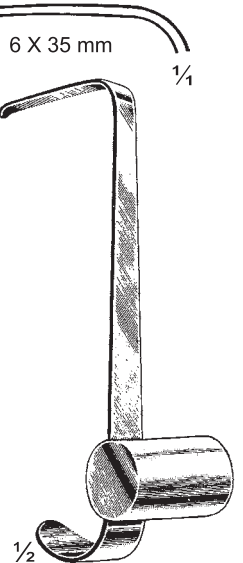

Cottle
635-14-13
 13 cm / 5 1/8"

Nasenmeißel, Osteotome, Nasensägen Rhinoplastic Chisels, Osteotomes, Nasal Saws Ciseaux-burins nasaux, Ostéotomes, Scies nasales

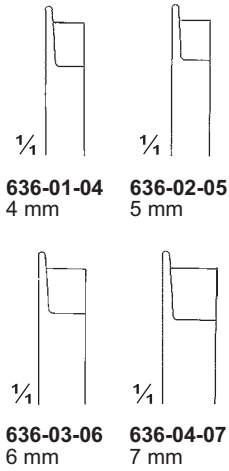

Fomon
636-01-04 To 636-04-07
17 cm / 6¾"

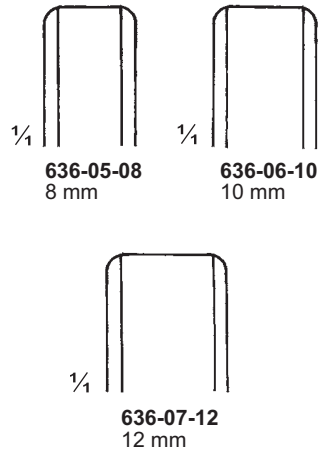
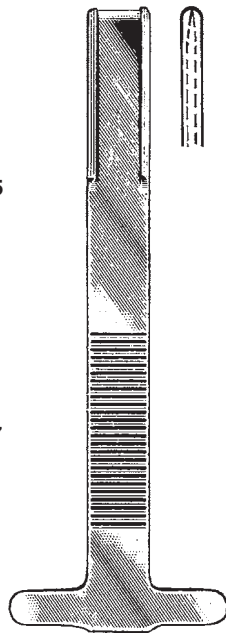

Rubin
636-05-08 To 636-07-12
18 cm / 7"

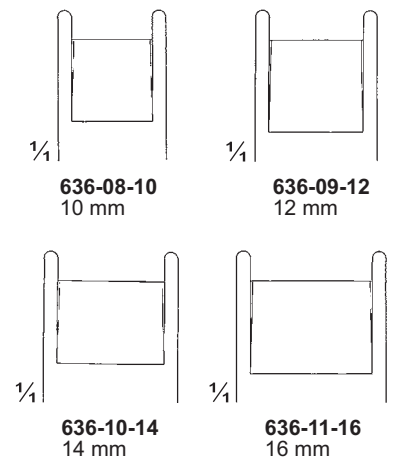

Cinelli
636-08-10 To 636-11-16
18 cm / 7"

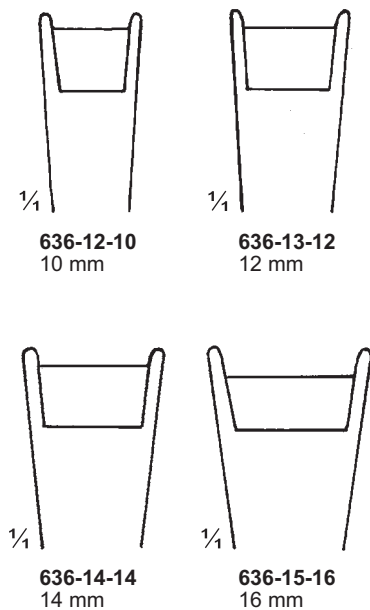
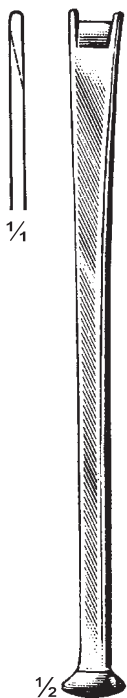

Moberg
636-12-10 To 636-15-16
18 cm / 7"

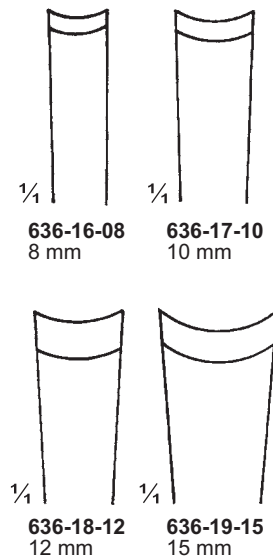

McIndoe
636-16-08 To 636-19-15
16 cm / 6¼"

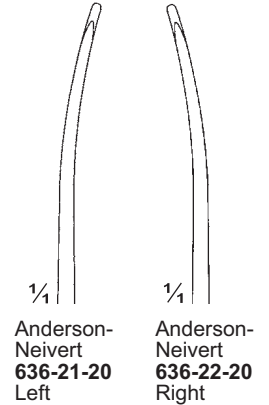

Neivert
636-20-20
636-20-20 To 636-22-20
20 cm / 8"

Nasenmeißel, Osteotome, Nasensägen
Rhinoplastic Chisels, Osteotomes, Nasal Saws
Ciseaux-burins nasaux, Ostéotomes, Scies nasales

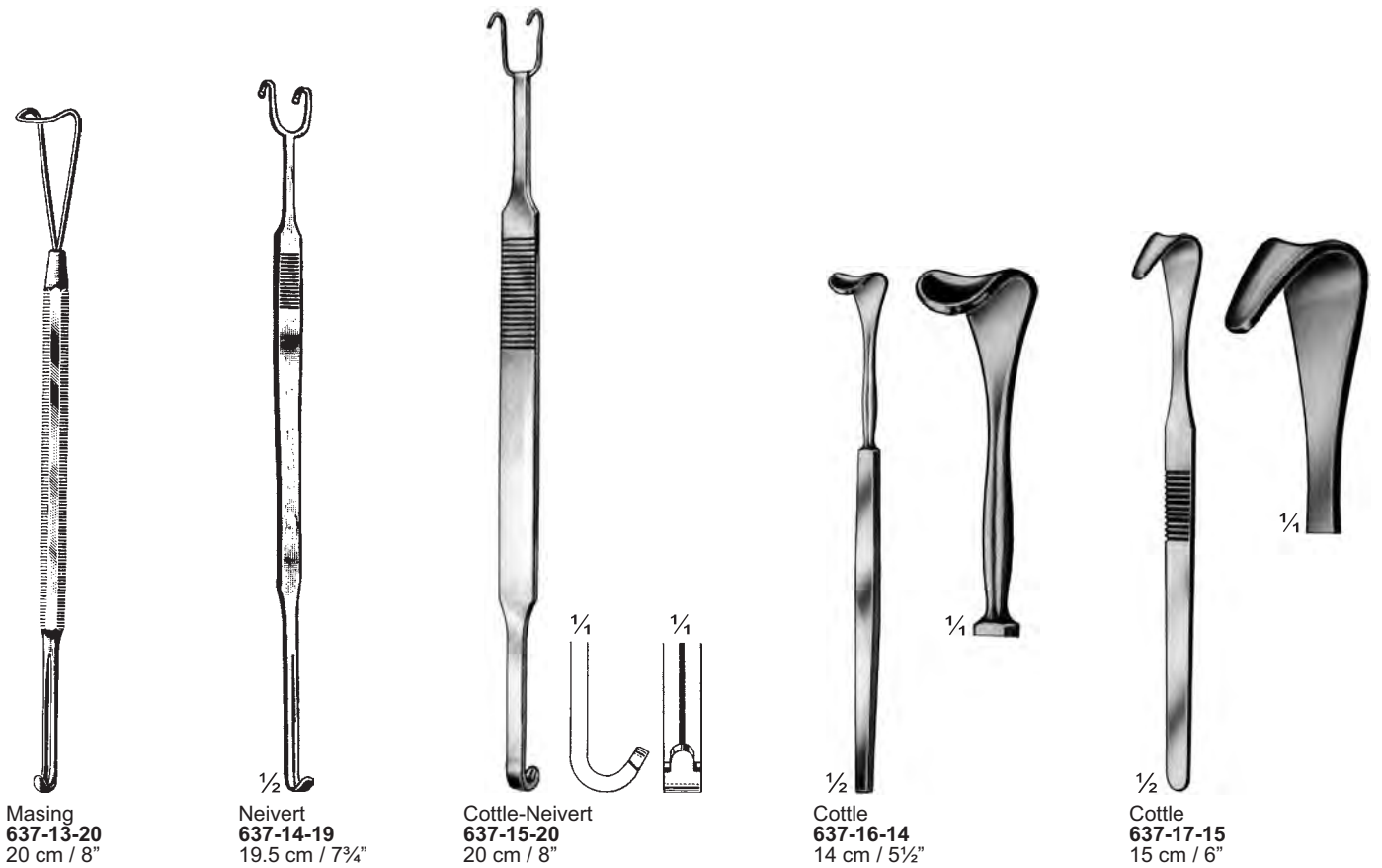
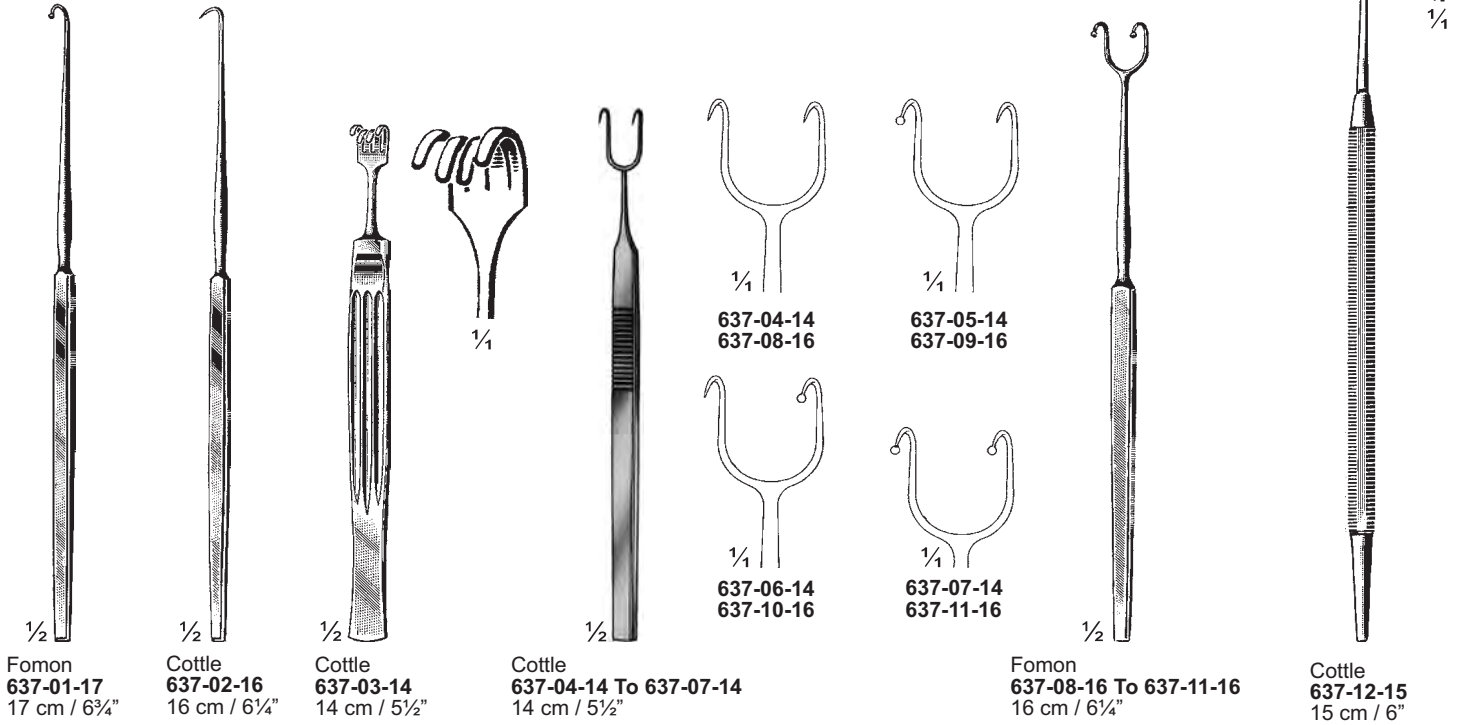

Nasenmeißel, Osteotome, Nasensägen
Rhinoplastic Chisels, Osteotomes, Nasal Saws
Ciseaux-burins nasaux, Ostéotomes, Scies nasales

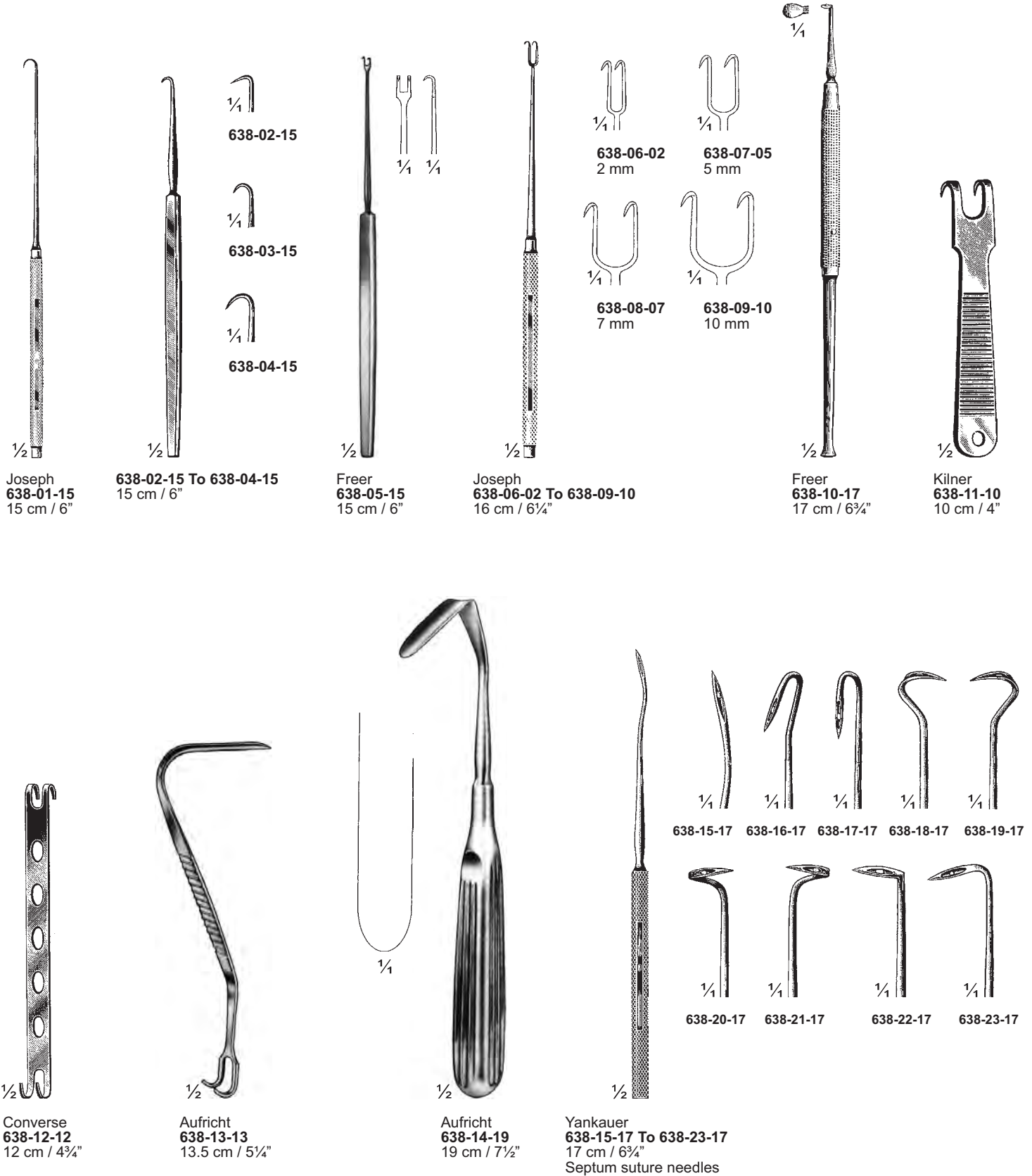

Nasenmeißel, Osteotome, Nasensägen
 Rhinoplastic Chisels, Osteotomes, Nasal Saws
 Ciseaux-burins nasaux, Ostéotomes, Scies nasales

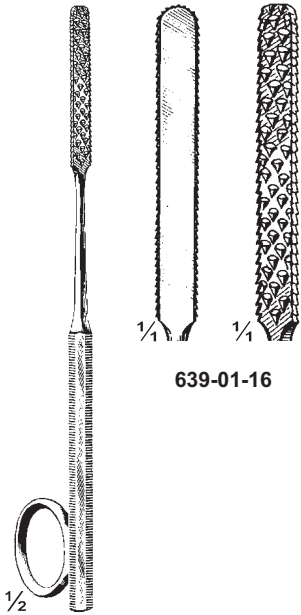

639-01-16

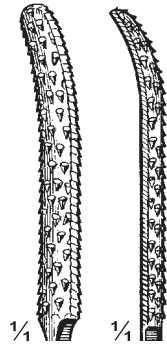

639-02-16

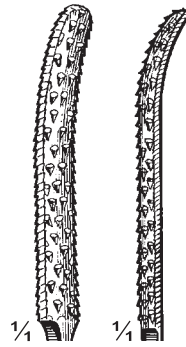

639-03-16

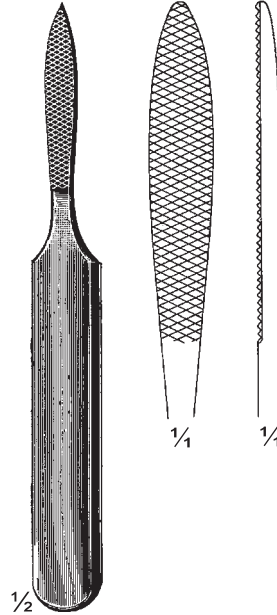

Joseph
 639-04-16
 16 cm / 6 1/4"

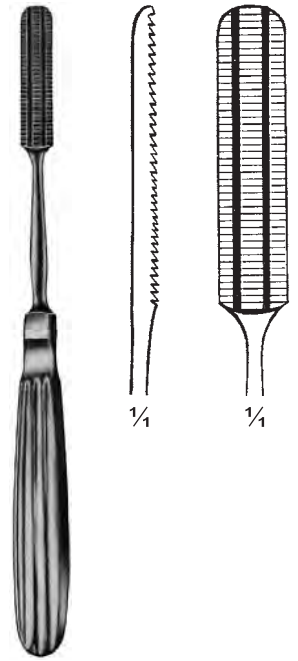

Maltz
 639-05-18
 18 cm / 7"

Gallaher
 639-01-16 To 639-03-16
 16 cm / 6 1/4"

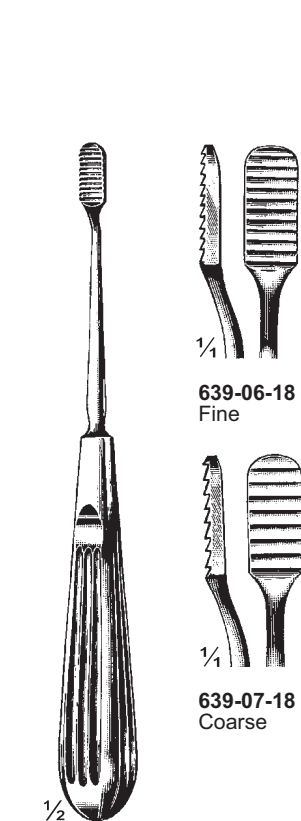

639-06-18
 Fine

639-07-18
 Coarse

Lewis
 639-06-18 & 639-07-18
 18 cm / 7"

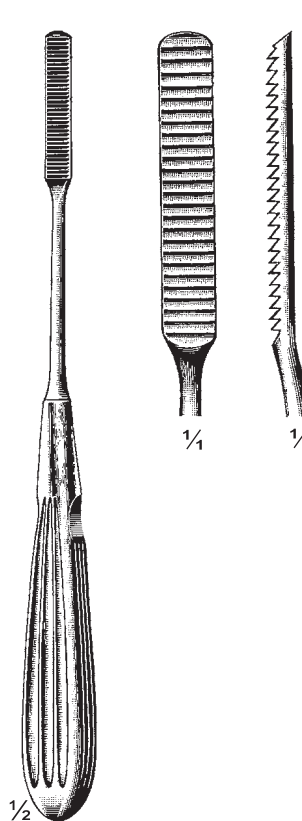

Cottle
 639-08-21
 21 cm / 8 1/4"

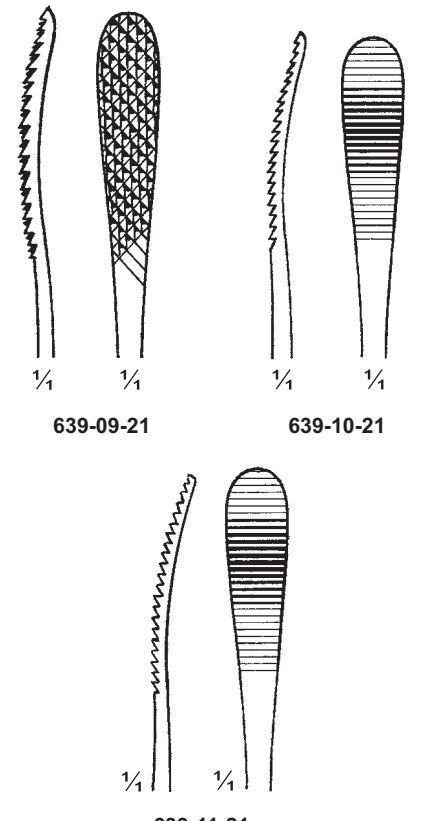

Aufrecht
 639-09-21 To 639-11-21
 21 cm / 8 1/4"

Nasenmeißel, Osteotome, Nasensägen
 Rhinoplastic Chisels, Osteotomes, Nasal Saws
 Ciseaux-burins nasaux, Ostéotomes, Scies nasales

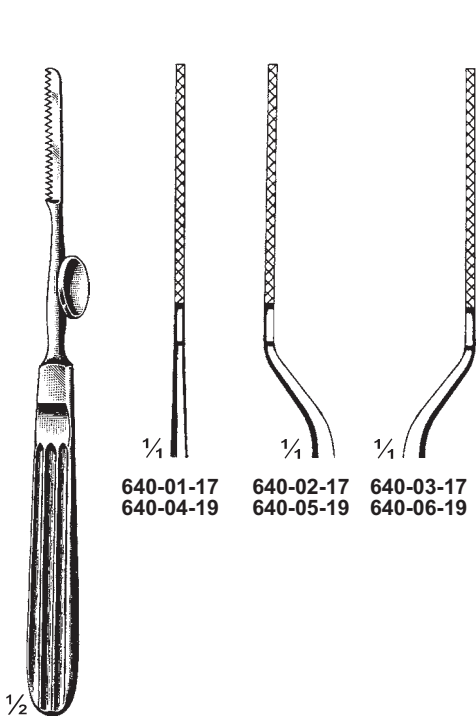

640-01-17 640-04-19
 640-02-17 640-05-19
 640-03-17 640-06-19

Joseph
 640-01-17 To 640-03-17
 17 cm / 6³/₄"



1/2

Joseph
 640-04-19 To 640-06-19
 19 cm / 7¹/₂"

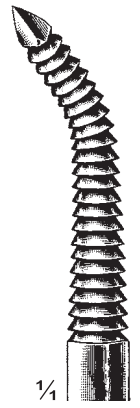

1/4

640-07-18



1/2

Wiener
 640-07-18 & 640-08-18
 18 cm / 7"



1/4

640-08-18

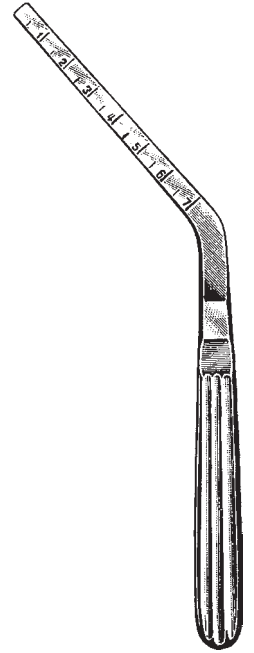

Joseph
 640-09-17
 17 cm / 6³/₄"

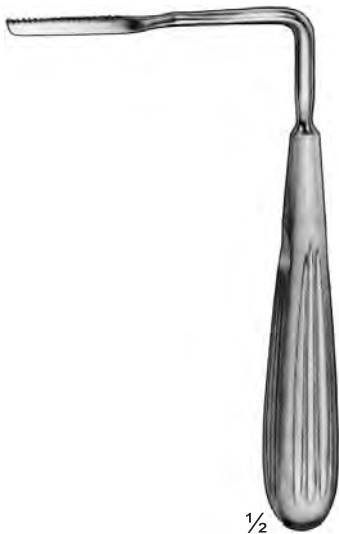

1/2

Joseph
 640-10-17
 17 cm / 6³/₄"

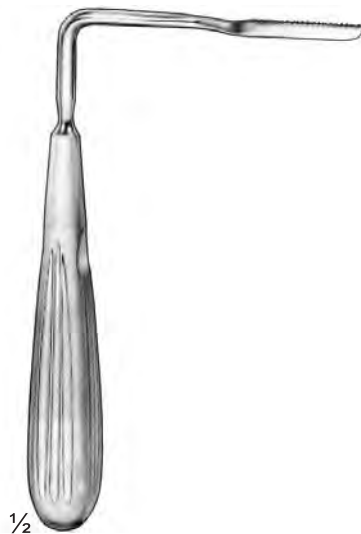

1/2

Joseph
 640-11-17
 17 cm / 6³/₄"

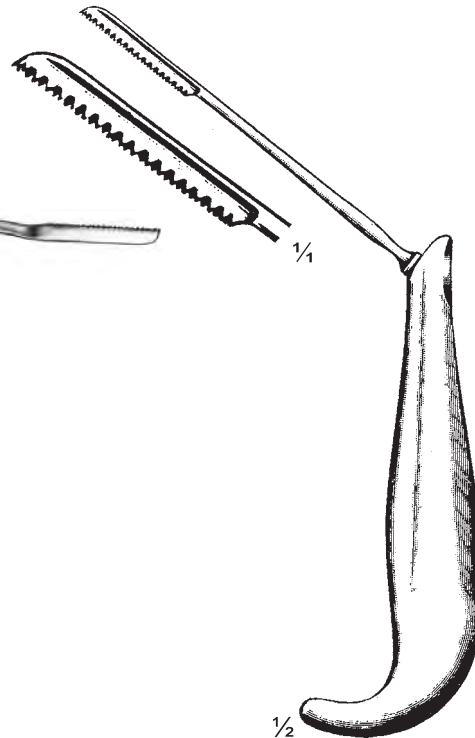

1/4

1/2

Mowlem
 640-12-21
 21 cm / 8¹/₄"

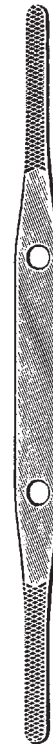

Masing
 640-13-21
 21 cm / 8¹/₄"

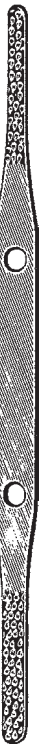

Masing
 640-14-21
 21 cm / 8¹/₄"

Nasenmeißel, Osteotome, Nasensägen
 Rhinoplastic Chisels, Osteotomes, Nasal Saws
 Ciseaux-burins nasaux, Ostéotomes, Scies nasales

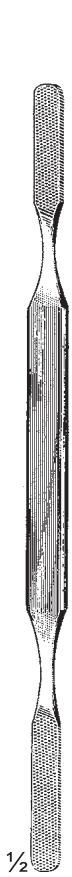

Fomon
 641-01-21
 21 cm / 8 1/4"



1/4



1/4



1/4



Converse
 641-02-18
 18.5 cm / 7 1/4"



1/4



1/2



1/2



1/2

Fomon
 641-03-20 To 641-07-20
 20 cm / 8"
 With tungsten carbide inserts



1 2

641-03-20

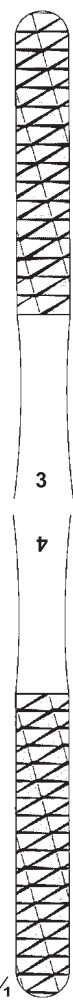

3 4

641-04-20

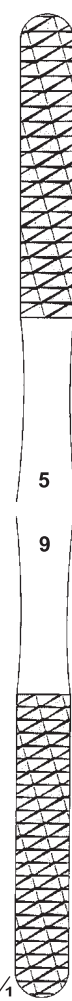

5 9

641-05-20

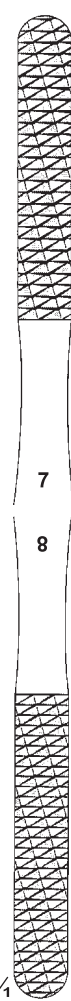

7 8

641-06-20



9 10

641-07-20

Nasenmeißel, Osteotome, Nasensägen
Rhinoplastic Chisels, Osteotomes, Nasal Saws
Ciseaux-burins nasaux, Ostéotomes, Scies nasales

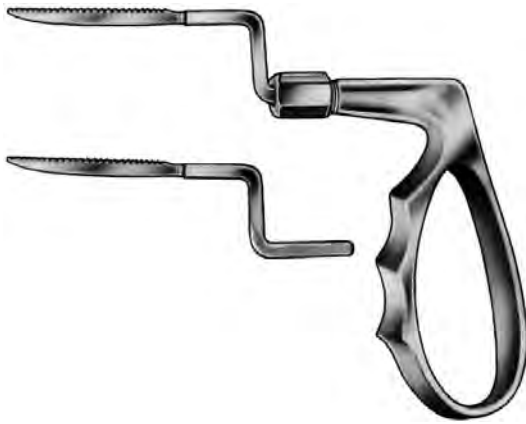

Cottle
642-01-00
 Complete consisting:
 1 Handle
 2 Saw blades
 1 Nutt and key



$\frac{1}{2}$
 Joseph
642-02-15
 15 cm / 6"

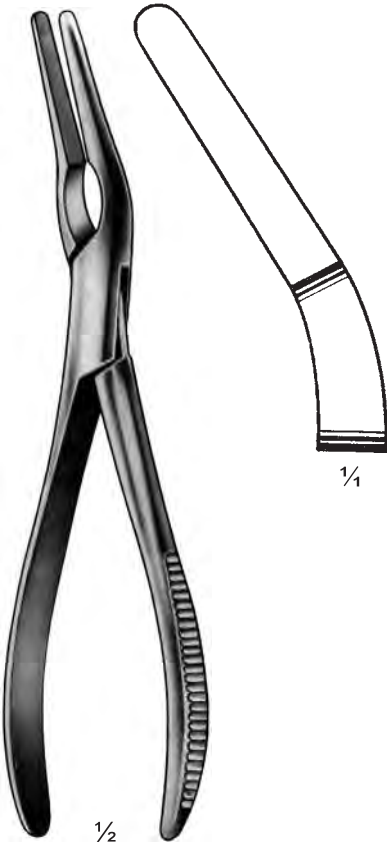

$\frac{1}{2}$
 Asch
642-03-22
 22 cm / 8 $\frac{3}{4}$ "



$\frac{1}{2}$
 Rubin
642-04-21
 21 cm / 8 $\frac{1}{4}$ "



$\frac{1}{2}$
 Kressner
642-05-02 To 642-07-05
 21 cm / 8 $\frac{1}{4}$ "

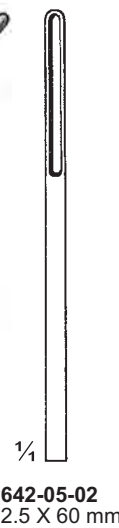

$\frac{1}{4}$
642-05-02
 2.5 X 60 mm

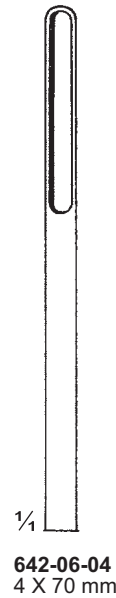

$\frac{1}{4}$
642-06-04
 4 X 70 mm

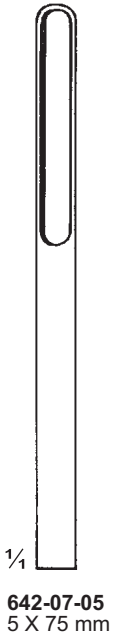

$\frac{1}{4}$
642-07-05
 5 X 75 mm

Nasenmeißel, Osteotome, Nasensägen
Rhinoplastic Chisels, Osteotomes, Nasal Saws
Ciseaux-burins nasaux, Ostéotomes, Scies nasales



Cottle-Walsham
643-01-21
 21 cm / 8 1/4"



643-02-23
 Right



Walsham
643-02-23 & 643-03-23
 23 cm / 9"



643-03-23
 Left



Walsham (Universal)
643-04-23
 23 cm / 9"



1/4



Tschoepe
643-05-19
 19 cm / 7 1/2"

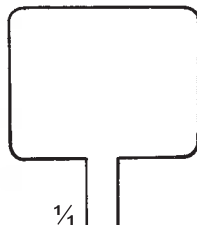

20 X 25 mm

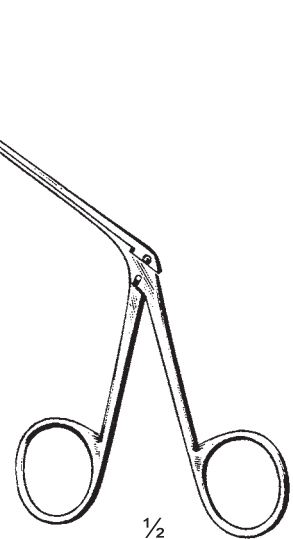
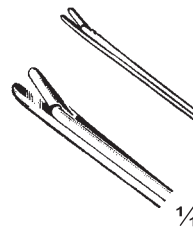

Cottle-Masing
643-06-06 Shaft 6 cm / 2 1/4"
643-07-09 Shaft 9 cm / 3 1/2"
 16 cm / 6 1/4"

Nasenmeißel, Osteotome, Nasensägen
Rhinoplastic Chisels, Osteotomes, Nasal Saws
Ciseaux-burins nasaux, Ostéotomes, Scies nasales



644-01-07
7.5 cm / 3"



Masing
644-02-08
8.5 cm / 3¼"

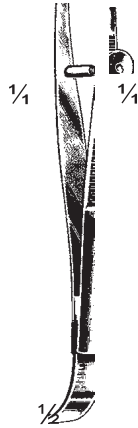

Ogura
644-03-11
11 cm / 4¼"



Cottle
644-04-11
11 cm / 4¼"



644-05-10
10 cm / 4"



Fox
644-06-13 13 cm / 5⅞"
644-07-15 15 cm / 6"
3 X 3 Teeth



¼



Fox
644-08-13
13 cm / 5⅞"
3 X 3 Teeth



¼



Fox
644-09-13 13 cm / 5⅞"
644-10-15 15 cm / 6"
3 X 3 Teeth



¼



Fox
644-11-15
15 cm / 6"
3 X 3 Teeth



¼



Hinderer
644-12-13
13 cm / 5⅞"
2 X 2 Teeth



¼



Cottle
644-13-15
15 cm / 6"



¼



Cottle
644-14-14
14 cm / 5½"

¼



¼

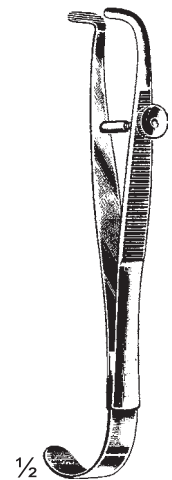

Guillen
644-15-12
12 cm / 4¾"

Tonsillenscheren
Tonsil Scissors
Ciseaux pour les amygdales

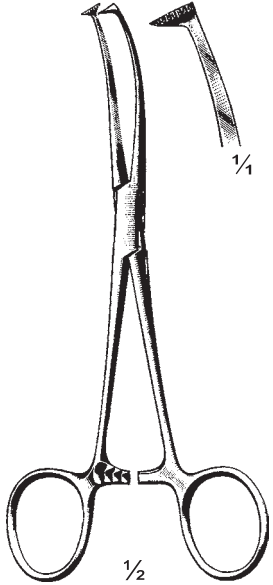

Fox
645-01-15
 15 cm / 6"

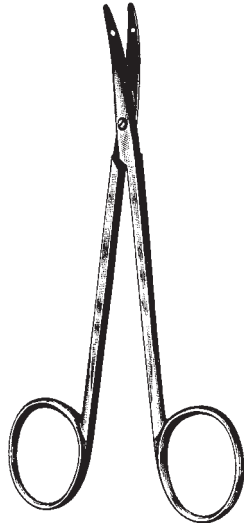

Littler
645-02-12
 12 cm / 4¾"

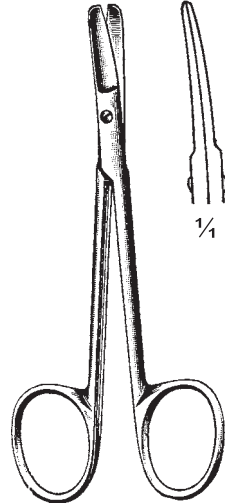

Cottle (Bulldog)
645-03-11
 11.5 cm / 4½"

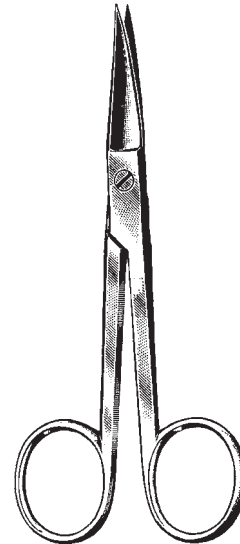

Converse
645-04-13
 13.5 cm / 5¼"



Castanares
645-05-16
 16 cm / 6¼"



McIndoe
645-06-19
 19 cm / 7½"

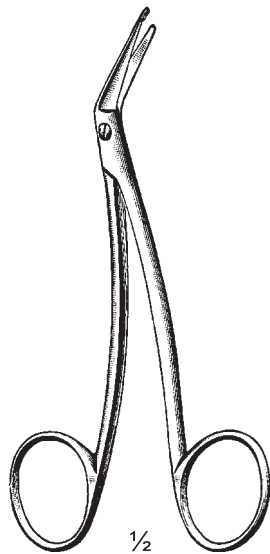

Taylor
645-07-14
 14 cm / 5½"



Cottle
645-08-16
 16 cm / 6¼"

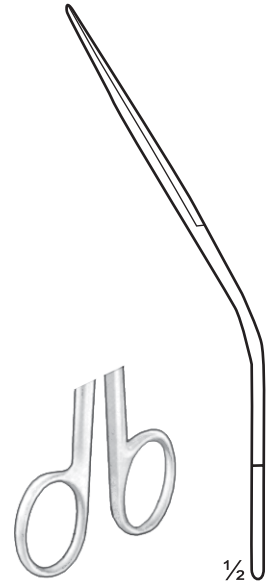

Cottle
645-09-16
 16 cm / 6¼"
 With Tungsten
 carbide inserts

Tonsillenscheren
Tonsil Scissors
Ciseaux pour les amygdales

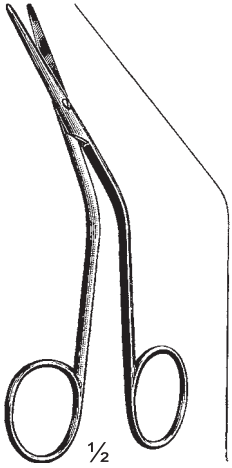

Fomon
646-01-13
 13 cm / 5 1/8"

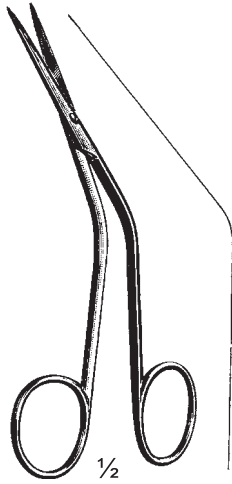

Fomon
646-02-13
 13 cm / 5 1/8"

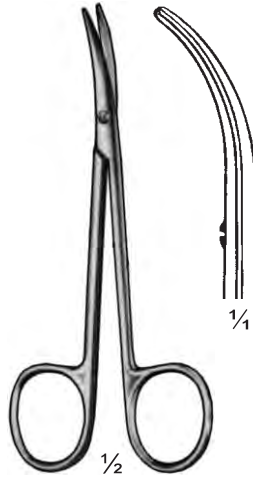

Fomon
646-03-12
 12.5 cm / 5"

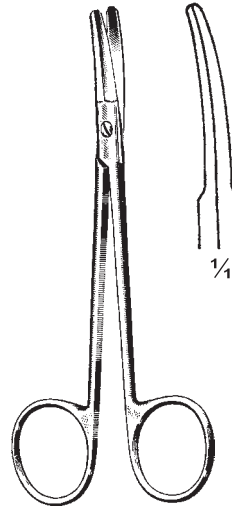

Fomon
646-04-12
 12.5 cm / 5"

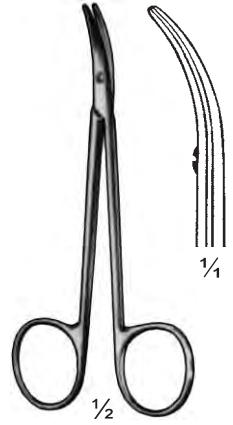

Cinelli
646-05-11
 11 cm / 4 1/4"

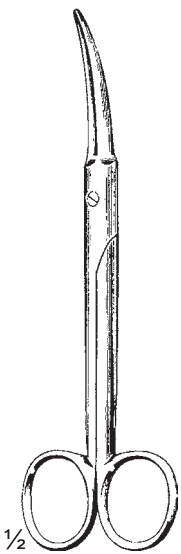

Aufrecht
646-06-14
 14 cm / 5 1/2"

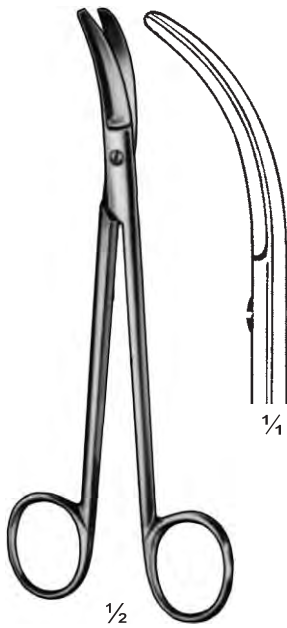

Joseph
646-07-16
 16.5 cm / 6 1/2"

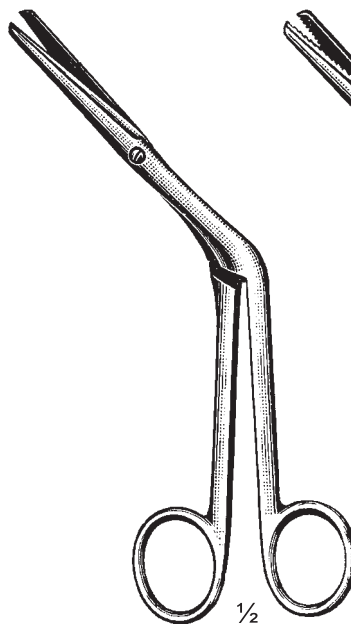

Heymann
646-08-17
 17 cm / 6 3/4"

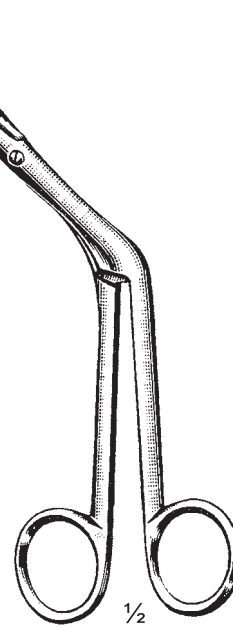

Heymann
646-09-17
 17 cm / 6 3/4"
 Serrated blades

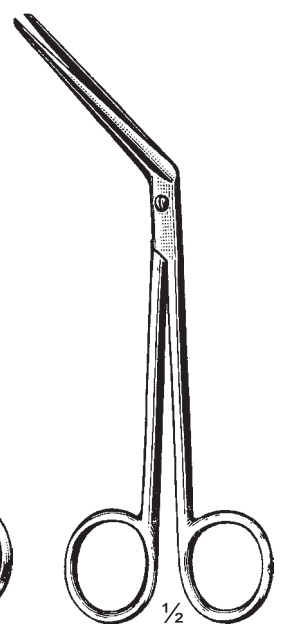

Seiler
646-10-17
 17 cm / 6 3/4"

Tonsillenscheren
Tonsil Scissors
Ciseaux pour les amygdales

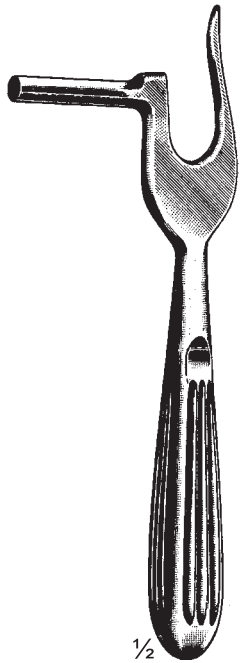

1/2

Quisling
647-01-17
 17 cm / 6 3/4"

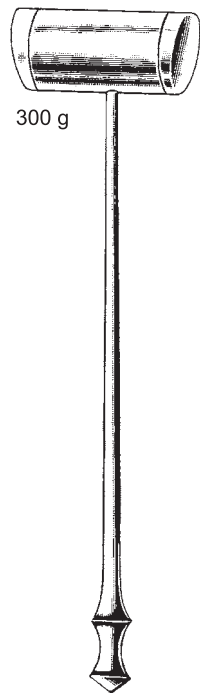

300 g

Guillen
647-02-300
 24 cm / 9 1/2"



300 g

Cottle
647-03-300
 19 cm / 7 1/2"



1/2

Dingman
647-04-15
 15 cm / 6"
 Left



1/2

Dingman
647-05-15
 15 cm / 6"
 Right



1/2

Coakley
647-17-06 To 647-11-17
 17 cm / 6 3/4"



1/4

647-06-17
647-12-19



1/4

647-07-17
647-13-19



1/4

647-08-17
647-14-19



1/4

647-09-17
647-15-19



1/4

647-10-17
647-16-19



1/4

647-11-17
647-17-19



Coakley
647-12-19 To 647-17-19
 19 cm / 7 1/2"



1/4

Faulkner
647-18-21
 21 cm / 8 1/4"

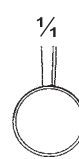

1/4

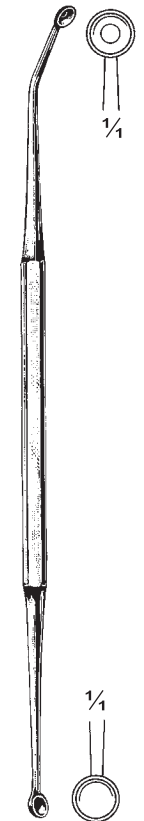

1/4

Pratt
647-19-21
 21 cm / 8 1/4"



1/4

**Ringmesser
Adenoid Curettes
Couteaux à végétations adénoïdales**

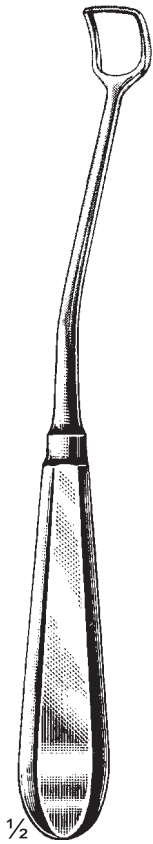

1/2

Beckmann
648-01-01 To 648-06-06
22 cm / 8 3/4"



1/4

648-01-01
648-07-01

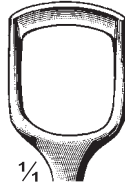

1/4

648-02-02
648-08-02

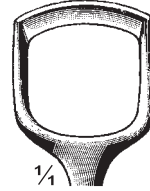

1/4

648-03-03
648-09-03

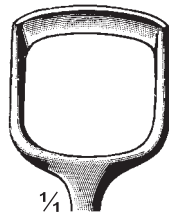

1/4

648-04-04
648-10-04

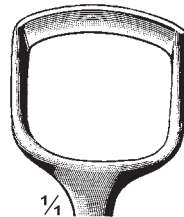

1/4

648-05-05
648-11-05

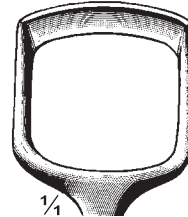

1/4

648-06-06
648-12-06



1/2

Beckmann
648-07-01 To 648-12-06
22 cm / 8 3/4"



1/2

Beckmann
648-13-01 To 648-17-05
22 cm / 8 3/4"

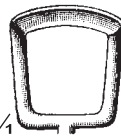

1/4

648-13-01

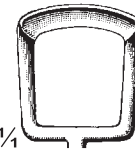

1/4

648-14-02

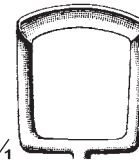

1/4

648-15-03

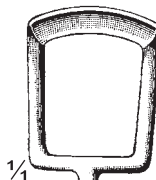

1/4

648-16-04

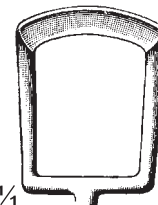

1/4

648-17-05

**Ringmesser
Adenoid Currettes
Couteaux à végétations adenoïdales**

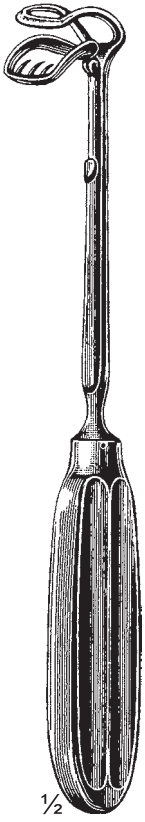

1/2

St. Clair-Thomson
649-01-01 To 649-04-04
21 cm / 8 1/4"

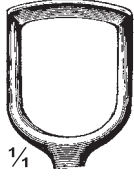

1/4

649-01-01

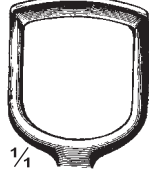

1/4

649-02-02

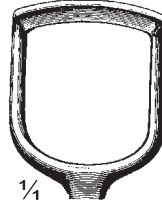

1/4

649-03-03

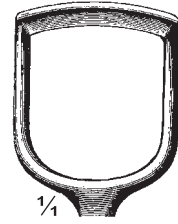

1/4

649-04-04

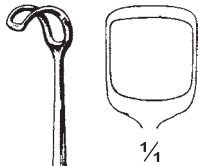

1/4

1/2

Ingersoll
649-05-21
21.5 cm / 8 1/2"

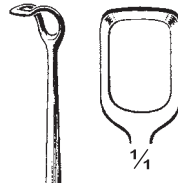

1/4

1/2

Vogel
649-06-21
21.5 cm / 8 1/2"



1/4

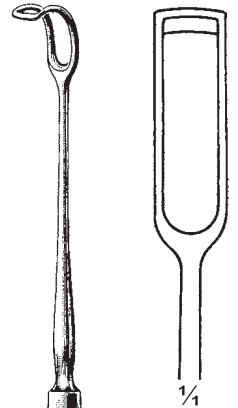

1/4

1/2

Meddleton
649-07-22
22 cm / 8 3/4"

Ringmesser Adenoid Currettes Couteaux à végétations adénoïdales

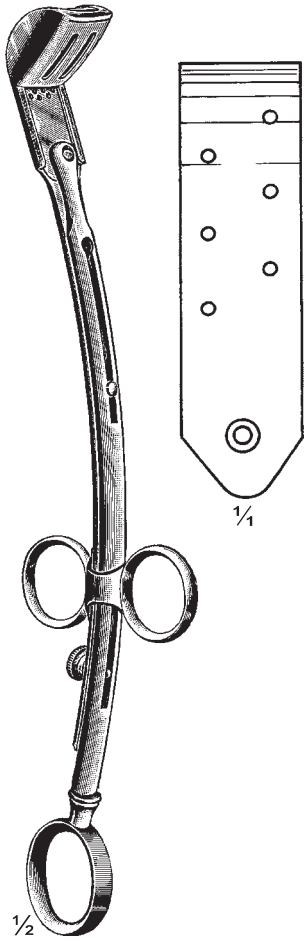
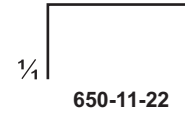
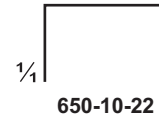
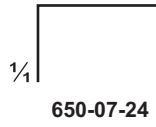
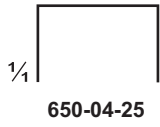
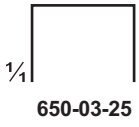
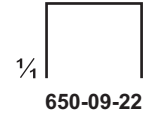
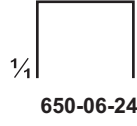
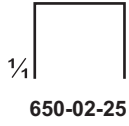

La Force
650-01-25 To 650-05-25
25 cm / 10"

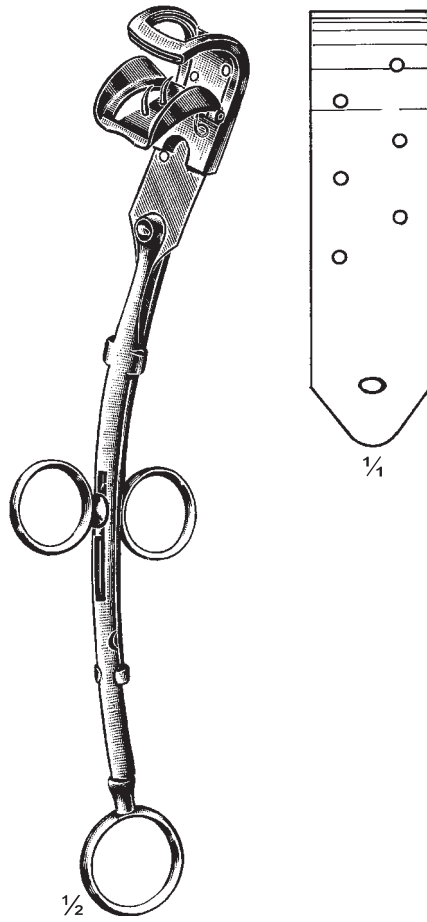

La Force-Stevenson
650-06-24 To 650-08-24
24 cm / 9 1/2"

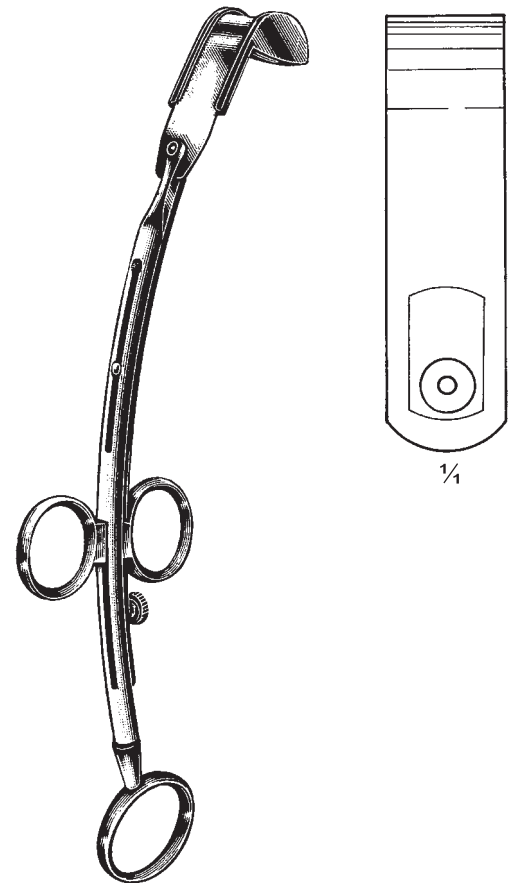

Shambaugh
650-09-22 To 650-11-22
22 cm / 8 3/4"

**Ringmesser
Adenoid Curettes
Couteaux à végétations adénoïdales**



Barnhill
651-01-01 To 651-05-05
22 cm / 8¾"

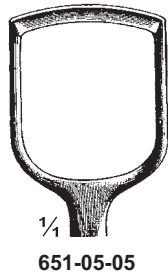
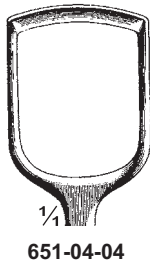
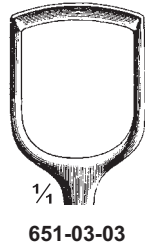
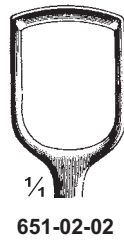
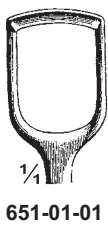

Moure
651-10-01 To 651-13-04
22 cm / 8¾"

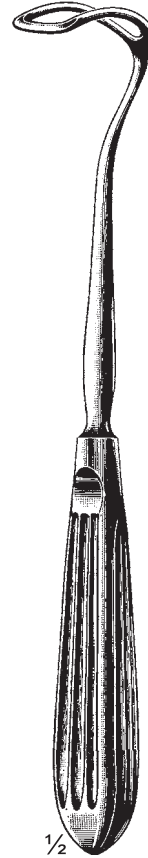
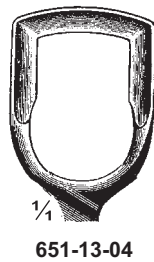
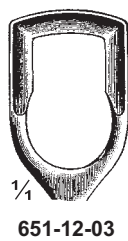
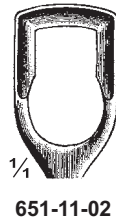

Stubbs
651-06-01 To 651-09-04
22 cm / 8¾"

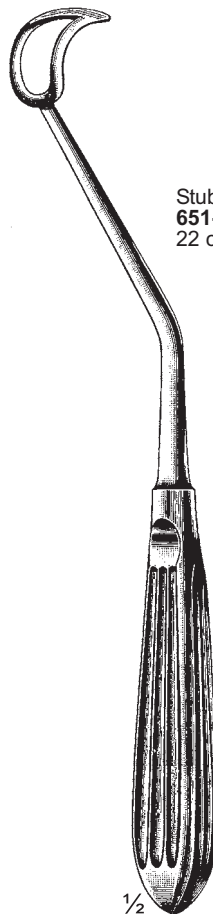
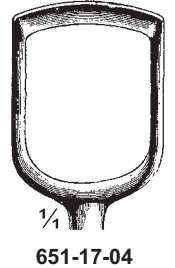
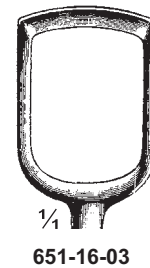
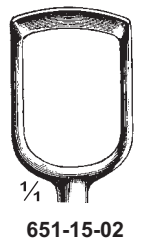
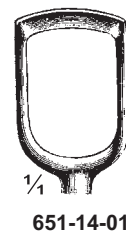
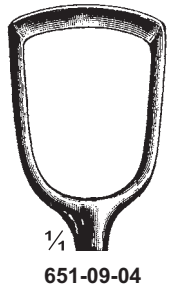
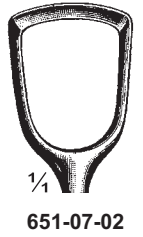
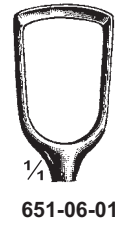

651-14 To 651-18
24 cm / 9½"

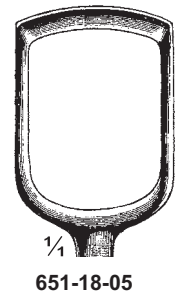

Ringmesser Adenoid Curettes Couteaux à végétations adénoïdales

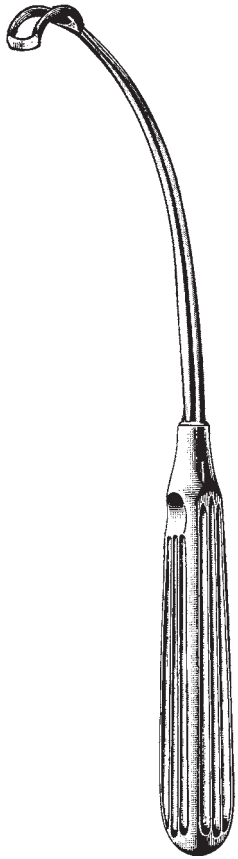

Shambaugh (Negus)
652-01-01 To 652-06-06
20 cm / 8"

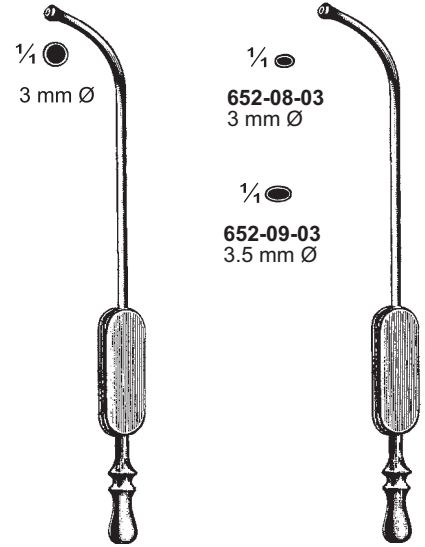
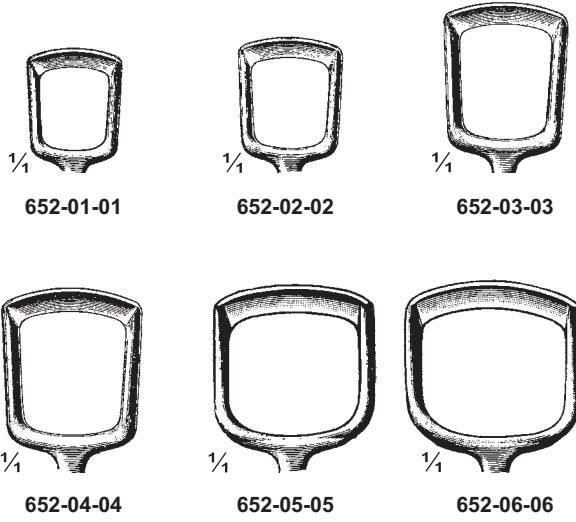

Eicken
652-07-03
15 cm / 6"

652-08-03
3 mm Ø

652-09-03
3.5 mm Ø

Killian
652-08-03 & 652-09-03
15 cm / 6"



Van Alyea
652-10-02
15 cm / 6"
2 mm Ø



Van Alyea
652-11-02
15 cm / 6"
2 mm Ø

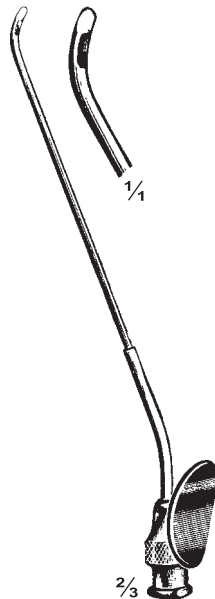

Van Alyea
652-12-01
12 cm / 4 3/4"
1.5 mm Ø

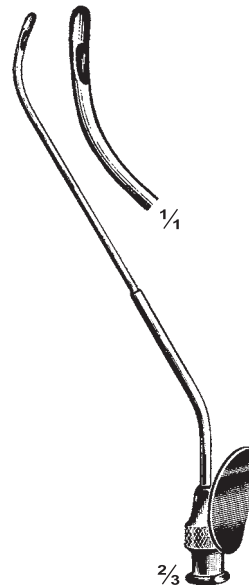

Van Alyea
652-13-01
12 cm / 4 3/4"
1.5 mm Ø

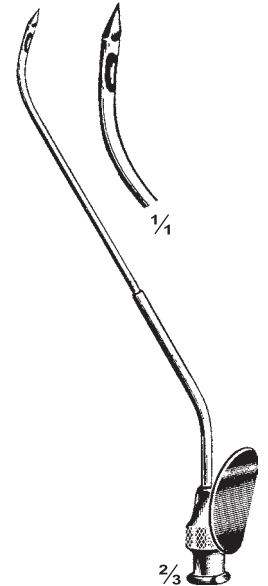

Van Alyea
652-14-01
12 cm / 4 3/4"
1.5 mm Ø

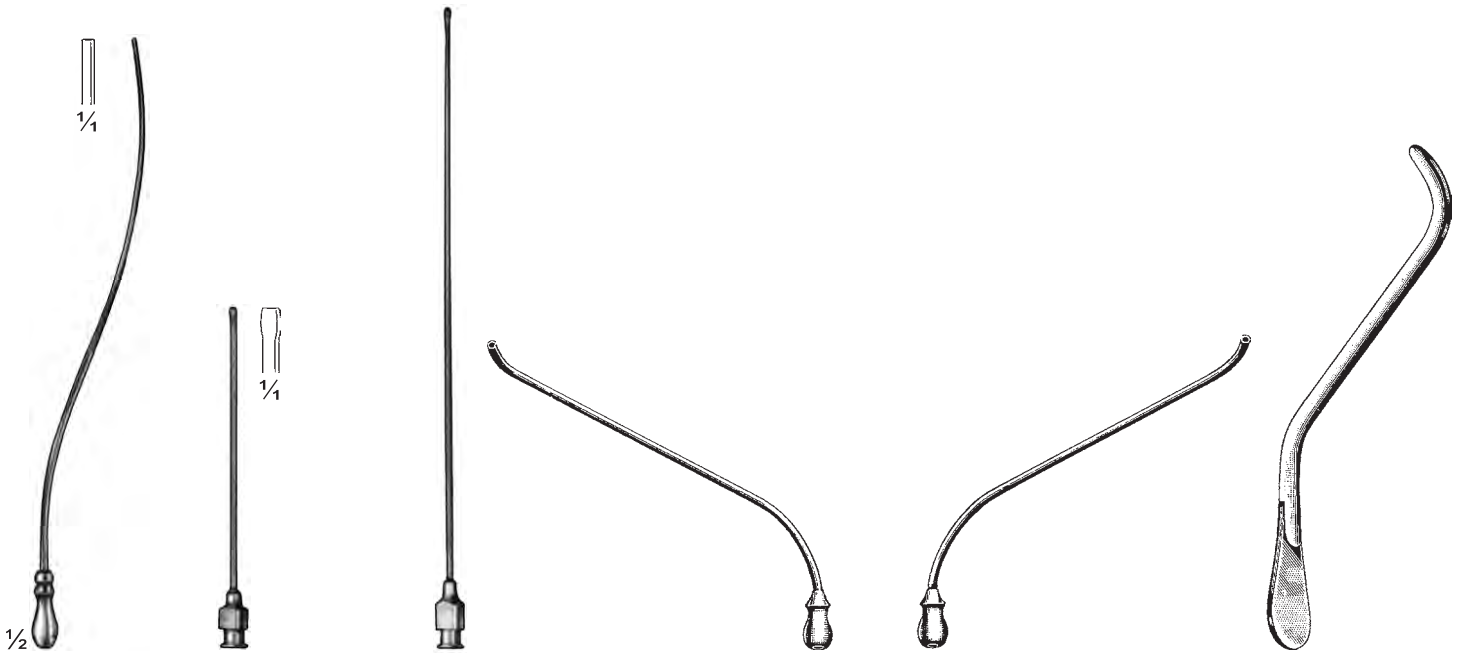

Killian
653-01-17
17 cm / 6³/₄"

Hajek
653-02-01 1.5 mm Ø
653-03-02 2.0 mm Ø
17 cm / 6³/₄"

Myles
653-04-01 9 cm / 3¹/₂"
653-05-01 11.5 cm / 4¹/₂"
1.8 mm Ø

Hartmann
653-06-02 12 cm / 4³/₄"
2 mm Ø

Hartmann
653-07-02 12 cm / 4³/₄"
2 mm Ø

Ritter-Halle
653-08-02 2.5 mm Ø
653-09-03 3.0 mm Ø
653-10-04 4.0 mm Ø
16 cm / 6¹/₄"



Guilen
653-11-20
20 cm / 8"

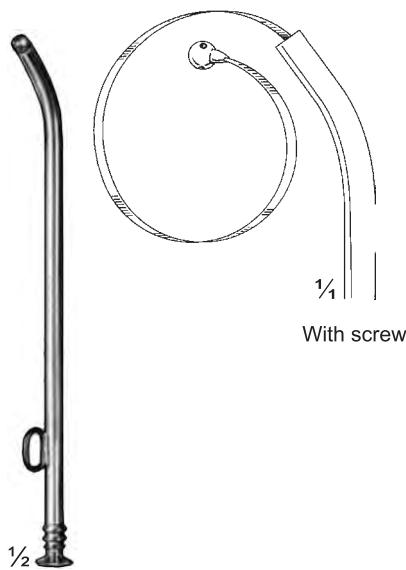

Bellocq
653-12-14
14 cm / 5¹/₂"

With screw

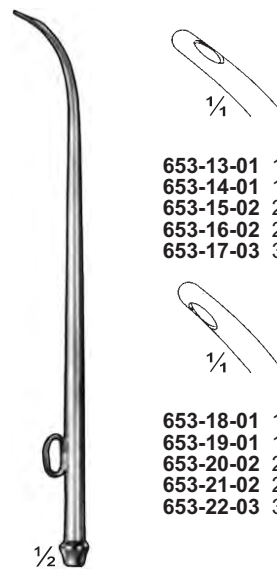

Siebenmann
653-13 To 653-22
15 cm / 6"

653-13-01 1.5 mm Ø
653-14-01 1.7 mm Ø
653-15-02 2.0 mm Ø
653-16-02 2.5 mm Ø
653-17-03 3.0 mm Ø

653-18-01 1.5 mm Ø
653-19-01 1.7 mm Ø
653-20-02 2.0 mm Ø
653-21-02 2.5 mm Ø
653-22-03 3.0 mm Ø



653-23-02
11 cm / 4¹/₄"
2 mm Ø

Keilbeinstanzen Punches Pinces emporte-pièces pour sinus sphénoïdal

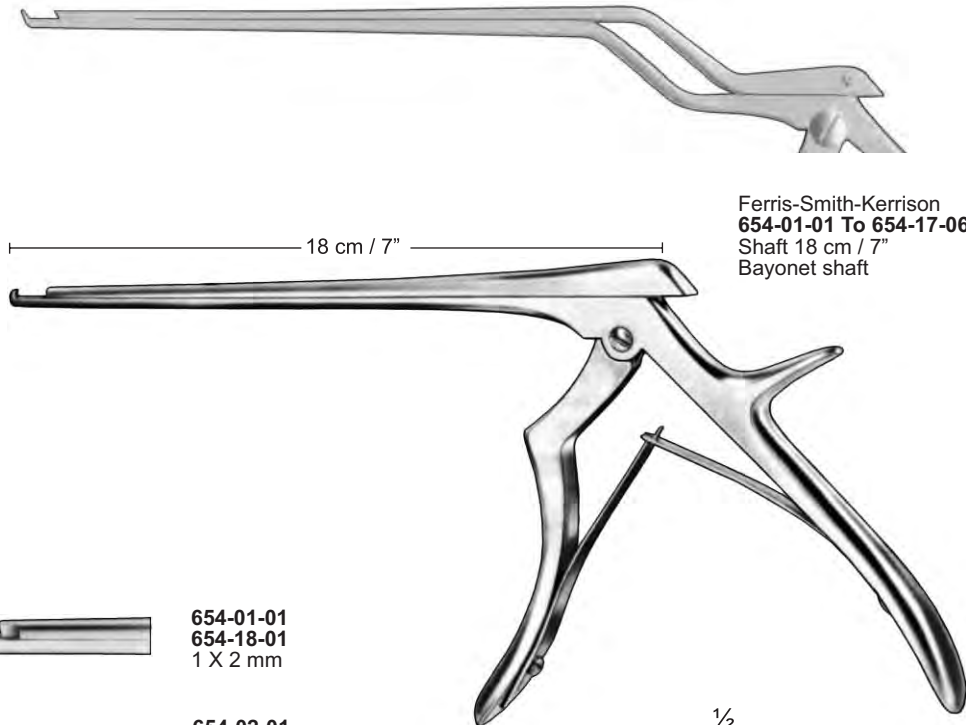

Ferris-Smith-Kerrison
654-01-01 To 654-17-06
Shaft 18 cm / 7"
Bayonet shaft

¼ ∅		654-01-01 654-18-01 1 X 2 mm	½		
¼ ∅		654-02-01 654-19-01 1 X 2 mm			
¼ ∅		654-03-02 654-20-02 2 X 2 mm			
¼ ∅		654-04-02 654-21-02 2 X 2 mm		¼ ∅	
¼ ∅		654-05-03 654-22-03 3 X 3 mm		¼ ∅	
¼ ∅		654-06-04 654-23-04 4 X 3 mm		¼ ∅	
¼ ∅		654-07-04 654-24-04 4 X 3 mm		¼ ∅	
¼ ∅		654-08-05 654-25-05 5 X 3 mm		¼ ∅	
¼ ∅		654-09-05 654-26-05 5 X 3 mm		¼ ∅	
¼ ∅		654-10-06 654-27-06 6 X 4 mm		¼ ∅	

Ferris-Smith-Kerrison
654-18-01 To 654-34-06
Shaft 18 cm / 7"

Keilbeinstanzen Punches Pinces emporte-pièces pour sinus sphénoïdal

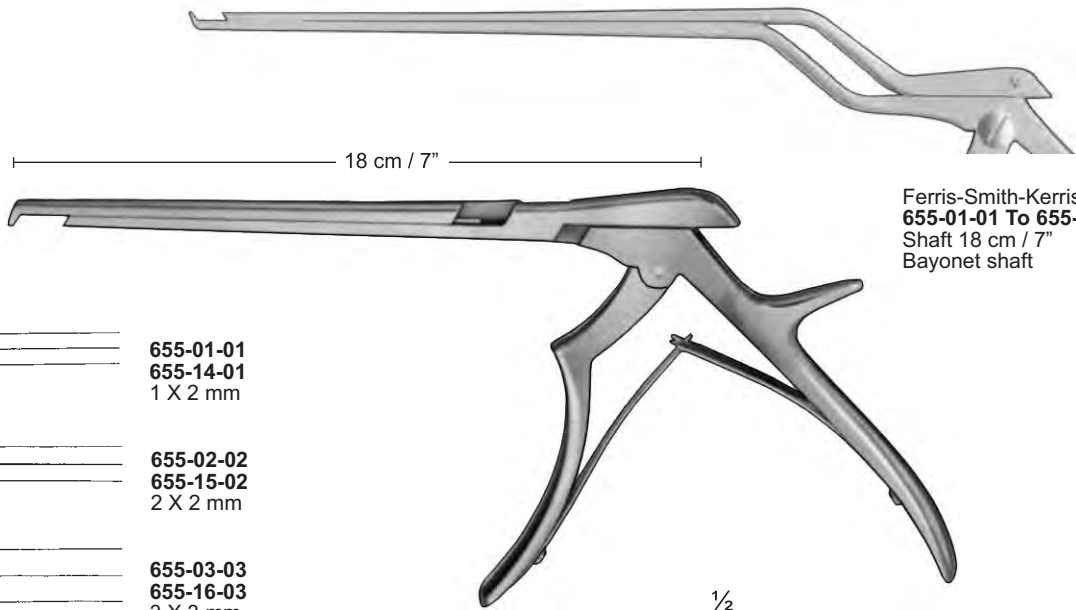

Ferris-Smith-Kerrison
655-01-01 To 655-13-06
Shaft 18 cm / 7"
Bayonet shaft

- 655-01-01**
655-14-01
 1 X 2 mm
- 655-02-02**
655-15-02
 2 X 2 mm
- 655-03-03**
655-16-03
 3 X 3 mm
- 655-04-04**
655-17-04
 4 X 3 mm
- 655-05-05**
655-18-05
 5 X 3 mm
- 655-06-06**
655-19-06
 6 X 4 mm

Ferris-Smith-Kerrison
655-14-01 To 655-26-06
Shaft 18 cm / 7"

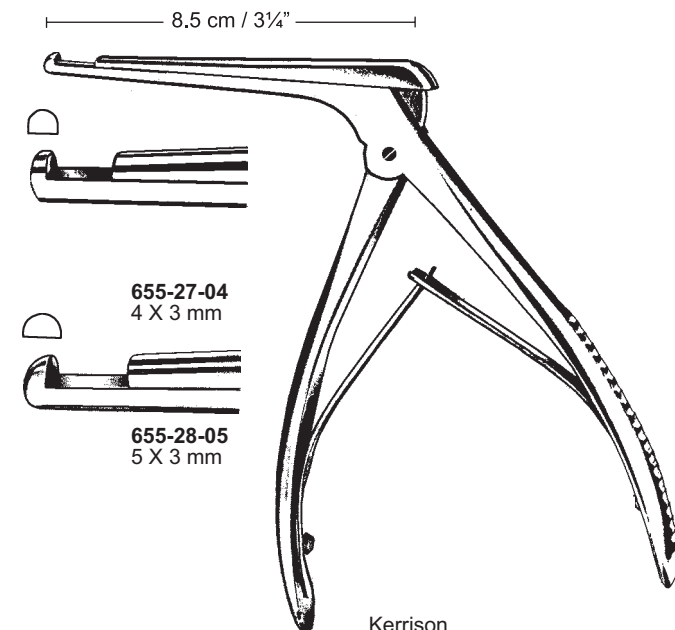

Kerrison
655-27-04 & 655-28-05
Shaft 8.5 cm / 3 1/4"

- 655-07-01**
655-20-01
 1 X 2 mm
- 655-08-01**
655-21-01
 1 X 2 mm
- 655-09-02**
655-22-02
 2 X 3 mm
- 655-10-03**
655-23-03
 3 X 4 mm
- 655-11-04**
655-24-04
 4 X 4 mm
- 655-12-05**
655-25-05
 5 X 5 mm
- 655-13-06**
655-26-06
 6 X 5 mm

Keilbeinstanzen Punches Pinces emporte-pièces pour sinus sphénoïdal

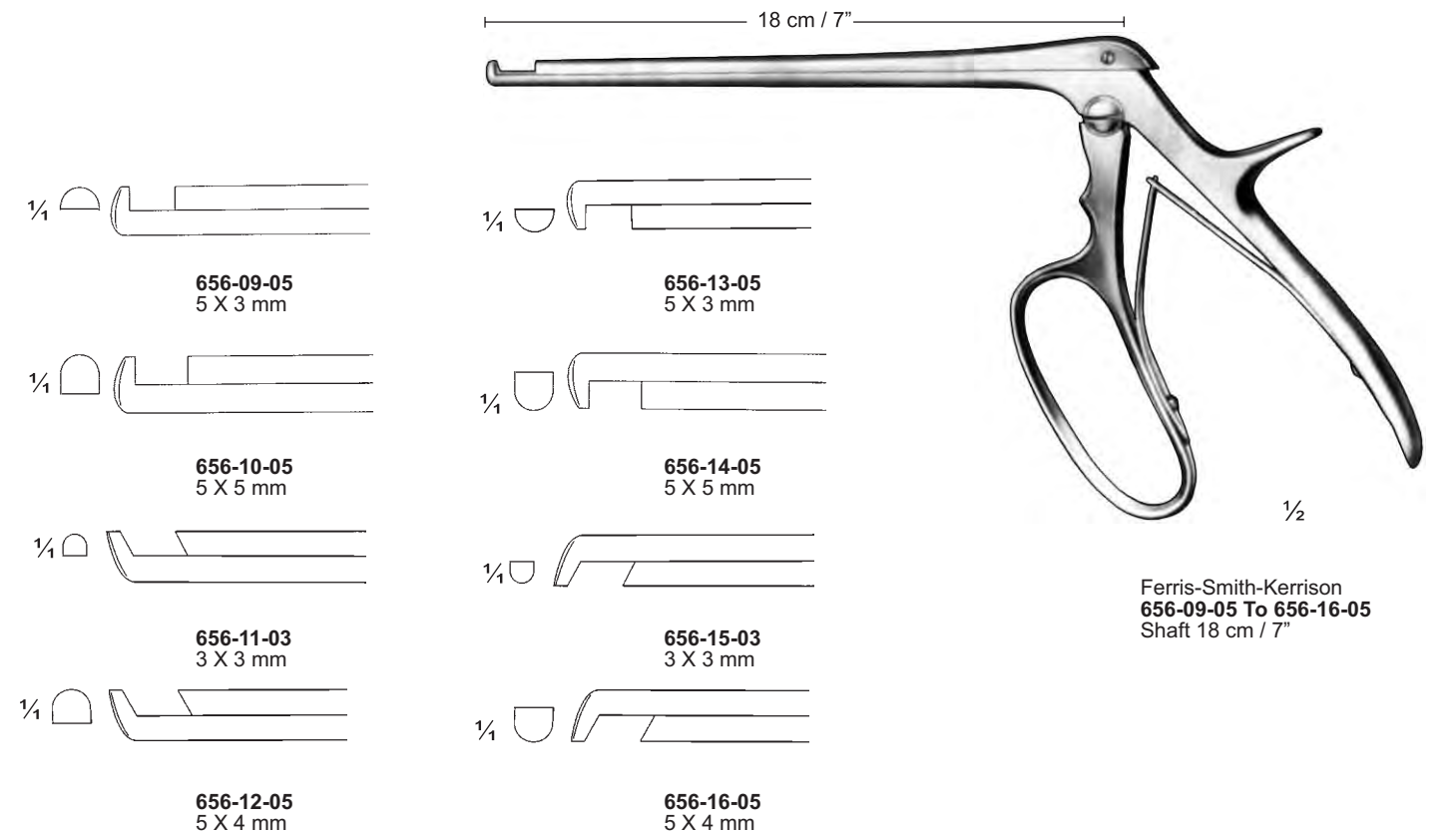
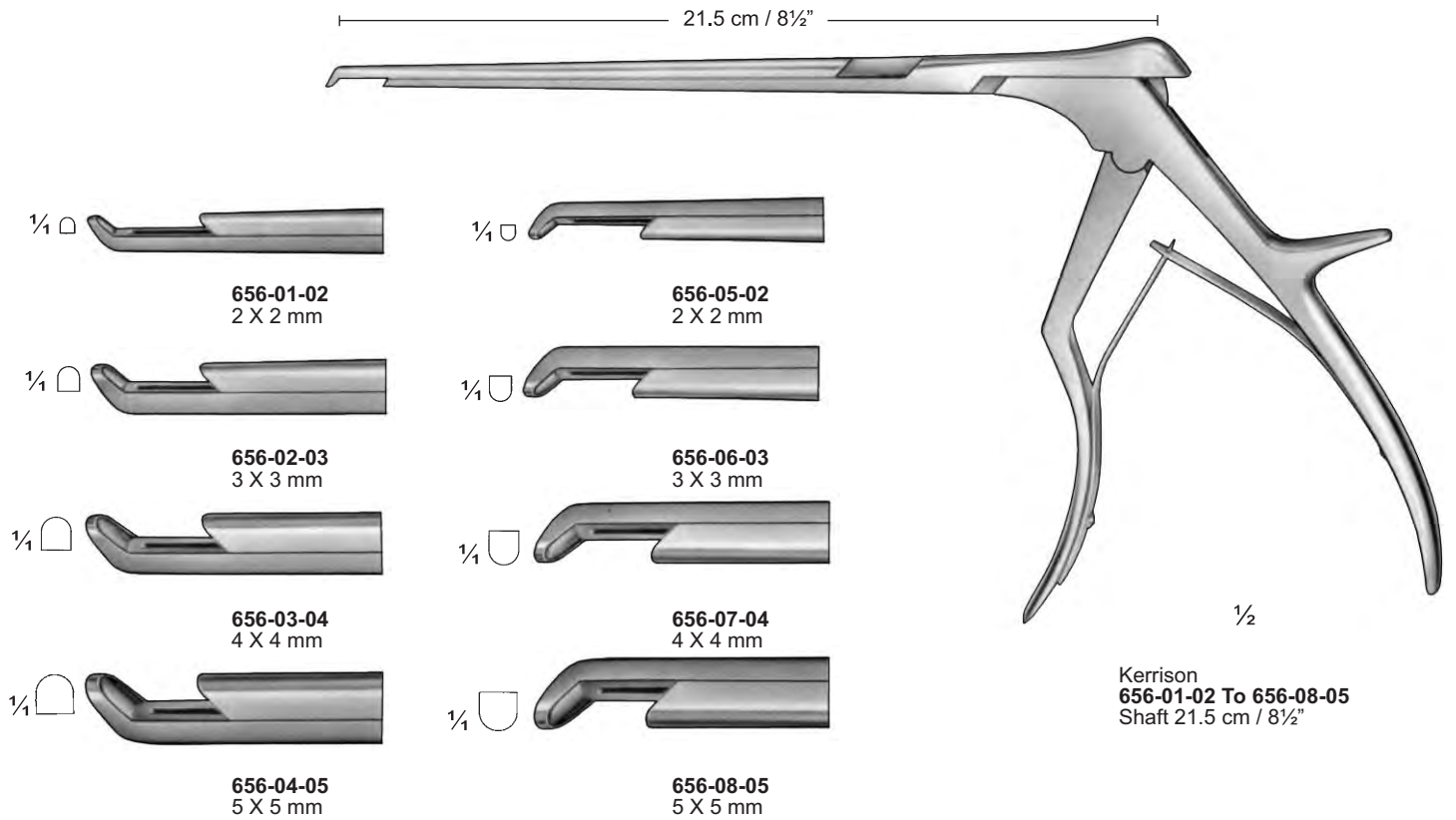

Keilbeinstanzen Punches Pinces emporte-pièces pour sinus sphénoïdal

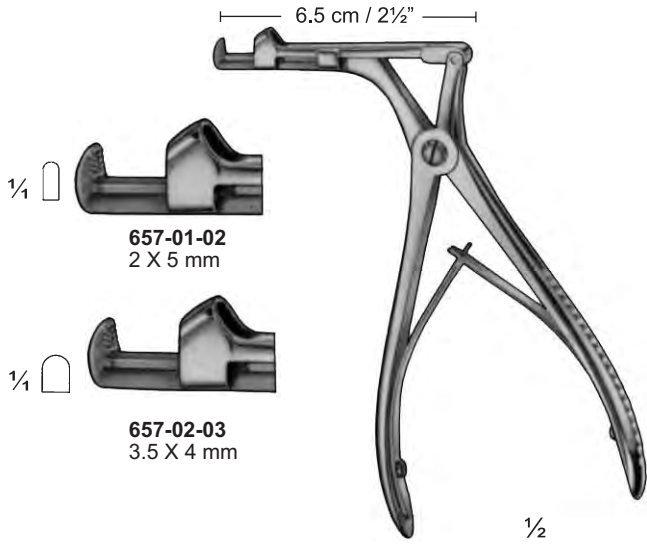

Citelli
657-01-02 & 657-02-03
Shaft 6.5 cm / 2 1/2"

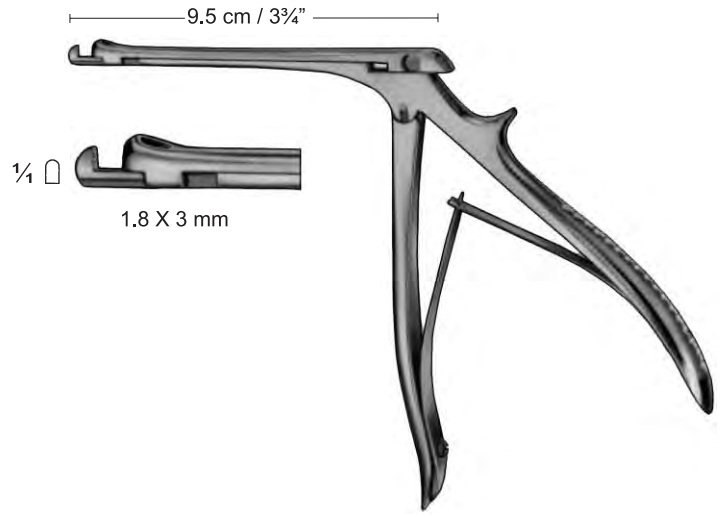

Beyer
657-03-01
Shaft 9.5 cm / 3 3/4"

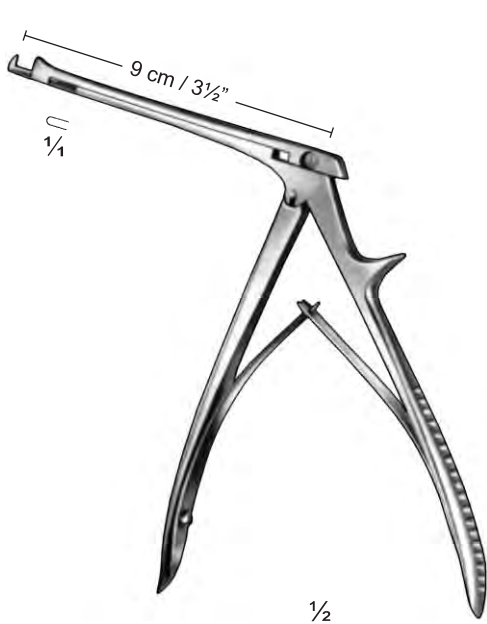

Beyer
657-04-09
Shaft 9 cm / 3 1/2"
Ultra delicate

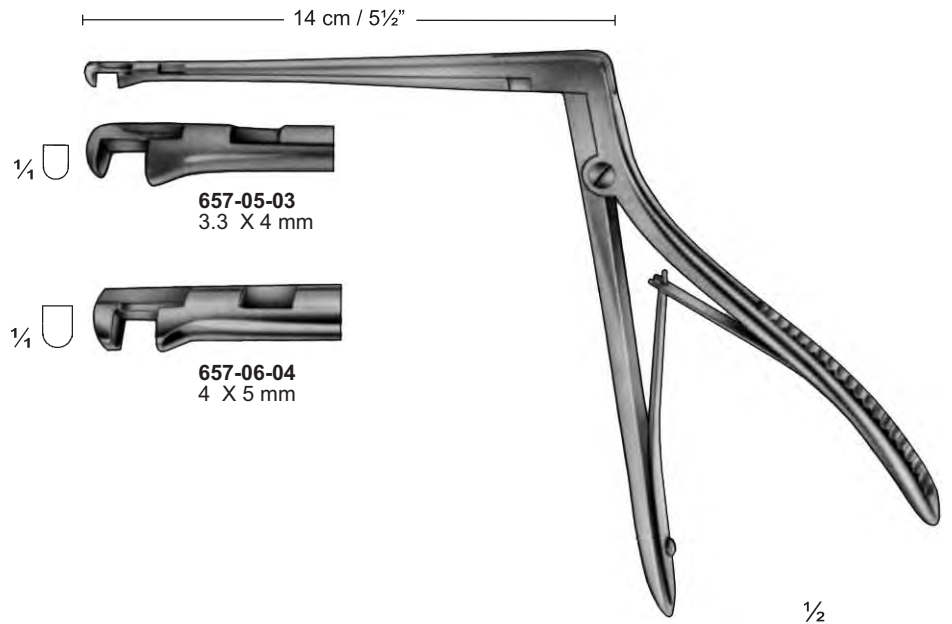

Hajek-Kofler
657-05-03 & 657-06-04
Shaft 14 cm / 5 1/2"

Keilbeinstanzen Punches Pinces emporte-pièces pour sinus sphénoïdal

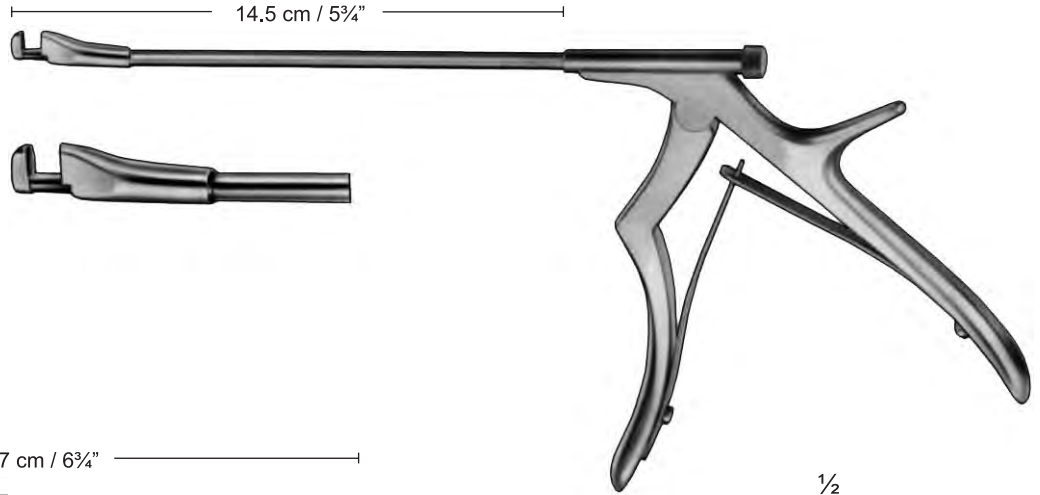

1/4
3 X 4 mm

1/2
Kofler
658-01-03
Shaft 14.5 cm / 5 3/4"

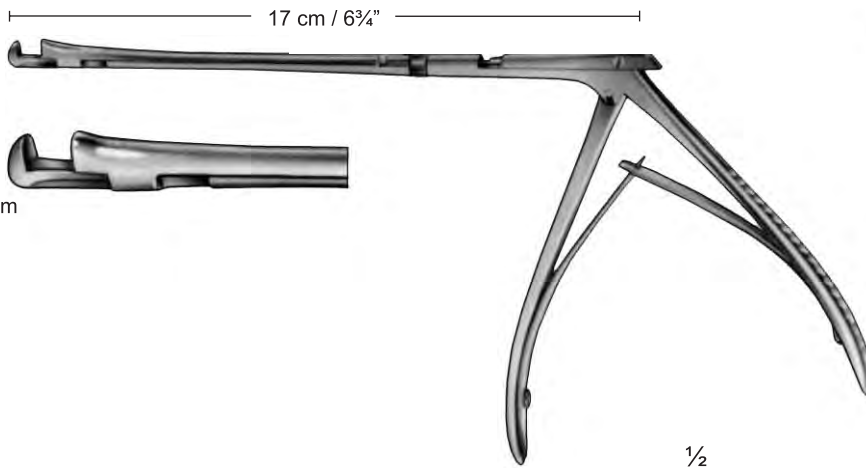

1/4
4 X 4 mm

1/2
Hajek-Kofler
658-02-04
Shaft 17 cm / 6 3/4"

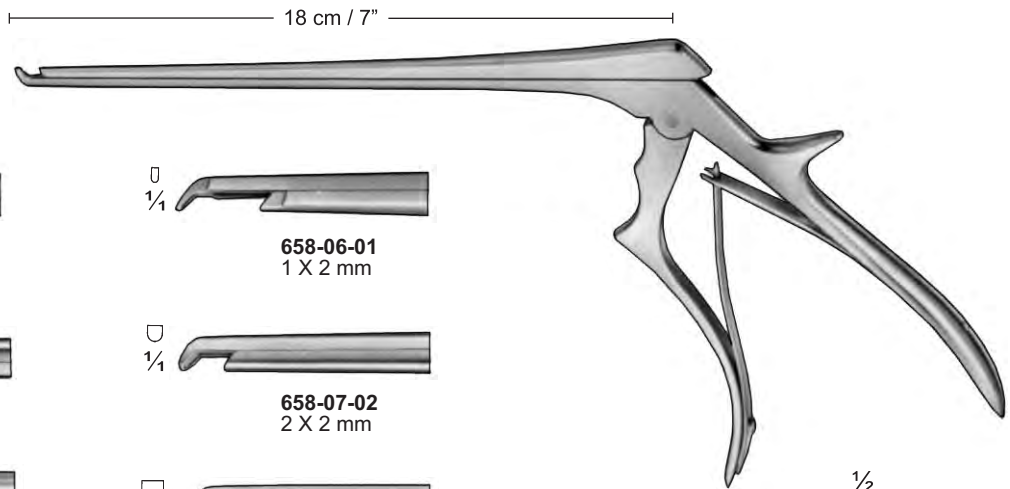

1/4
658-03-01
1 X 2 mm

1/4
658-06-01
1 X 2 mm

1/4
658-04-02
2 X 2 mm

1/4
658-07-02
2 X 2 mm

1/4
658-05-03
3 X 3 mm

1/4
658-08-03
3 X 3 mm

1/2
658-03-01 To 658-08-03
Shaft 18 cm / 7"

Keilbeinstanzen Punches Pinces emporte-pièces pour sinus sphénoïdal

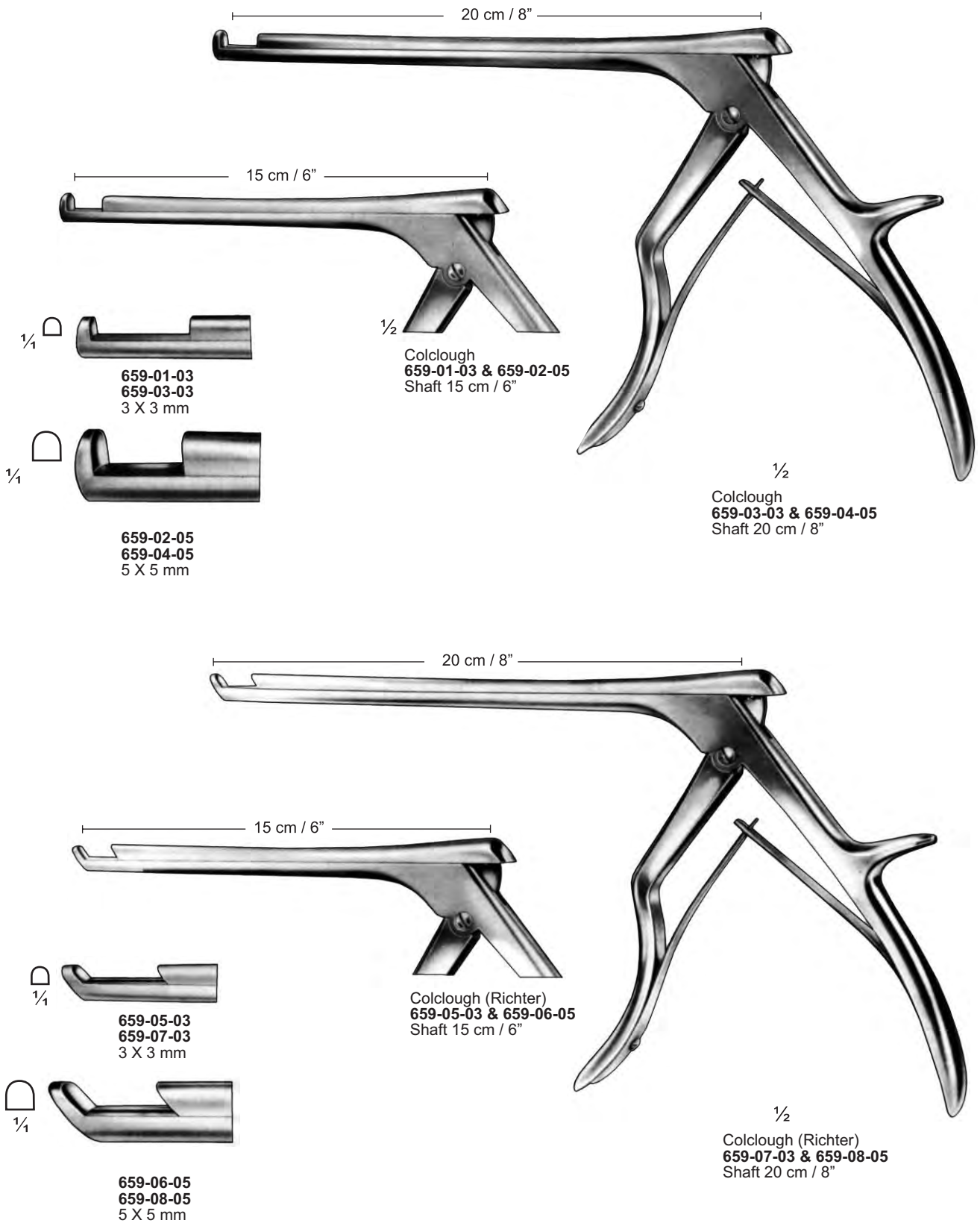

Keilbeinstanzen Punches Pinces emporte-pièces pour sinus sphénoïdal

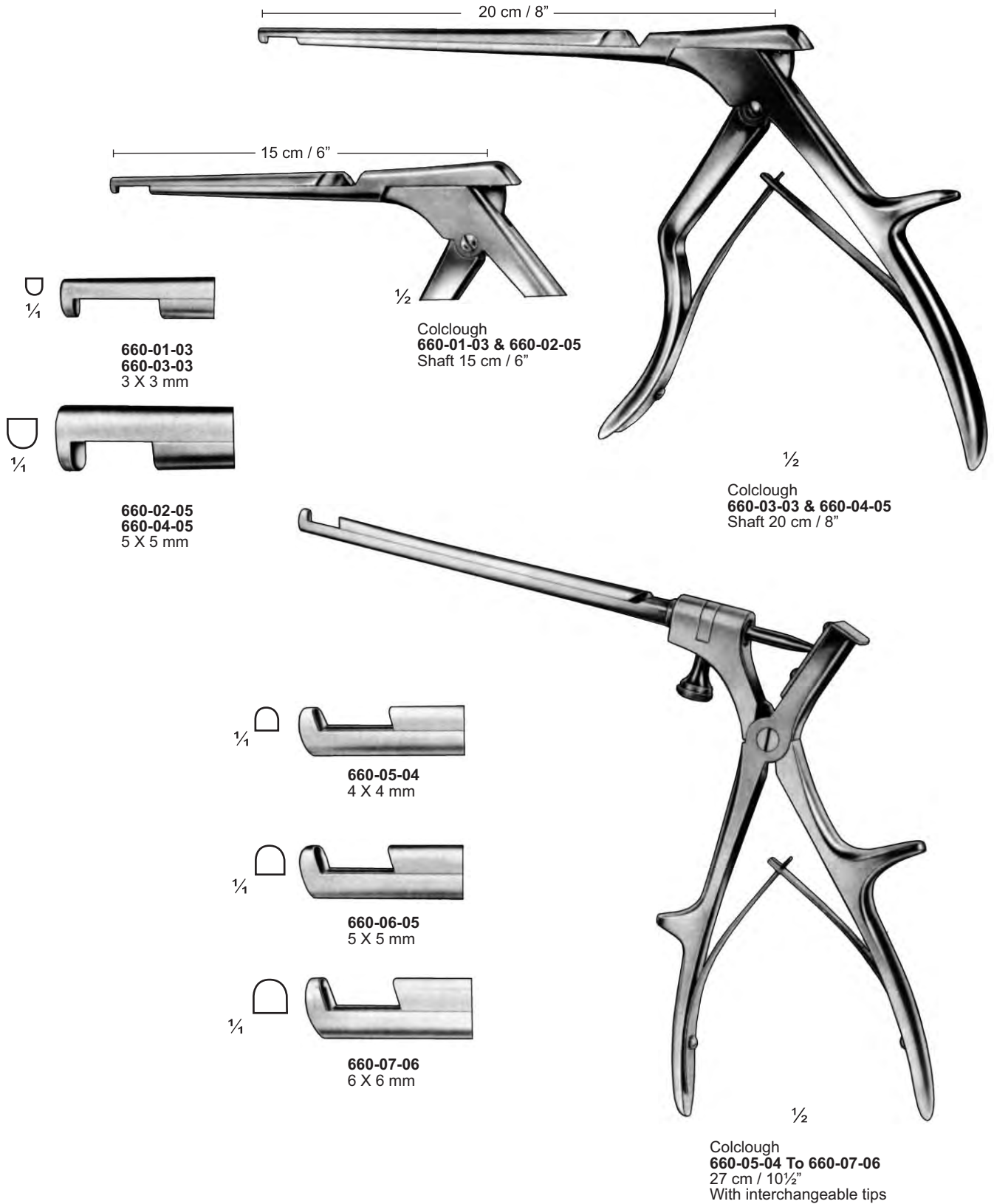

Keilbeinstanzen Punches Pinces emporte-pièces pour sinus sphénoïdal

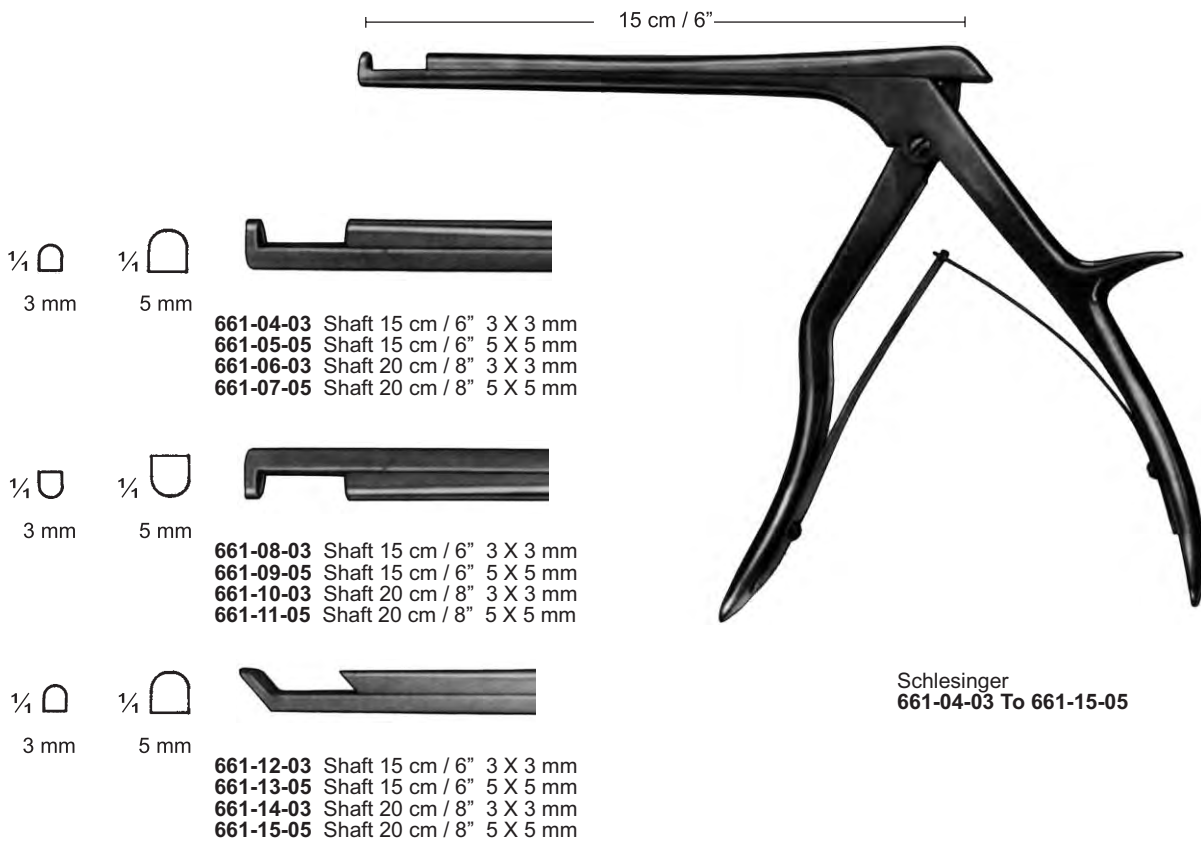
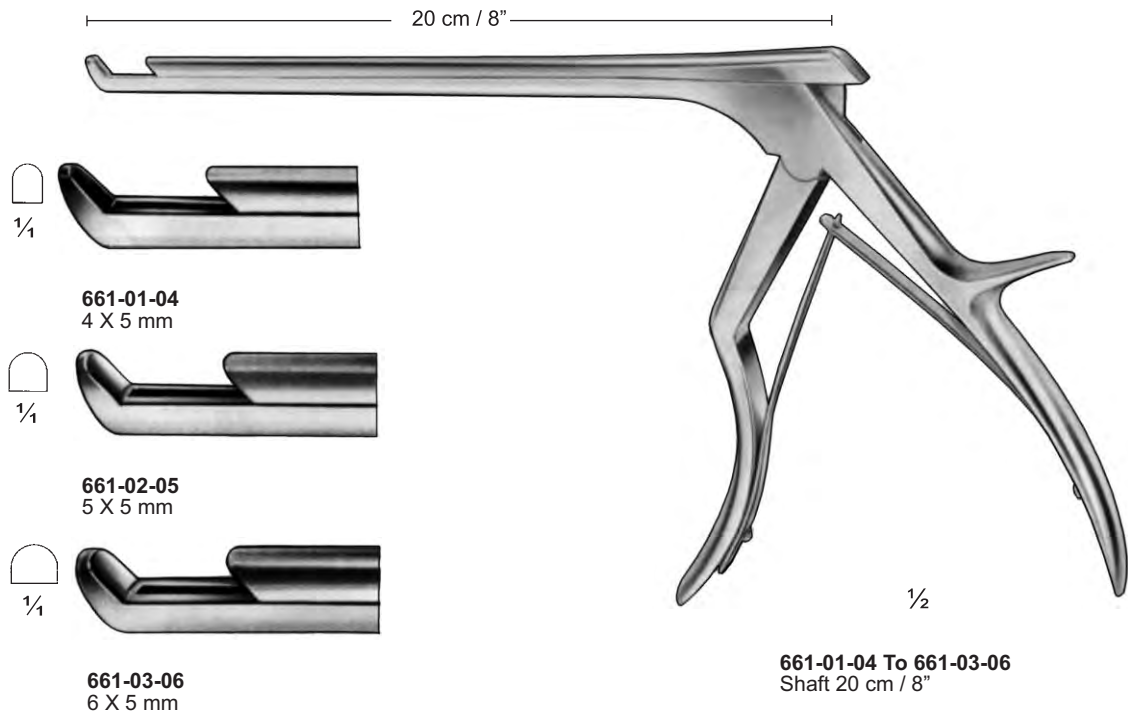

20 cm / 8"



1/4

662-01-05
5.5 X 8 mm

15 cm / 6"

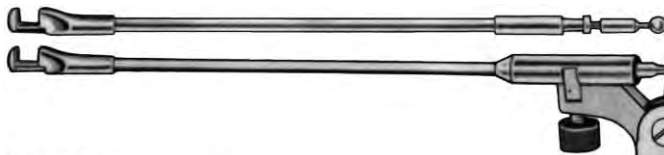

1/4



1/4

1/4



662-02-03 3 X 4 mm **662-03-03** 3.5 X 5 mm **662-04-05** 5 X 6 mm

Syvert
662-01-05
Shaft 25 cm / 10"

1/2

Ferris-Smith
662-02-03 To 662-04-05
Shaft 15 cm / 6"

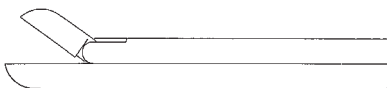

1/4

1/4

1/4

662-05-02 2 X 10 mm **662-06-03** 3 X 10 mm **662-07-04** 4 X 10 mm

15 cm / 6"

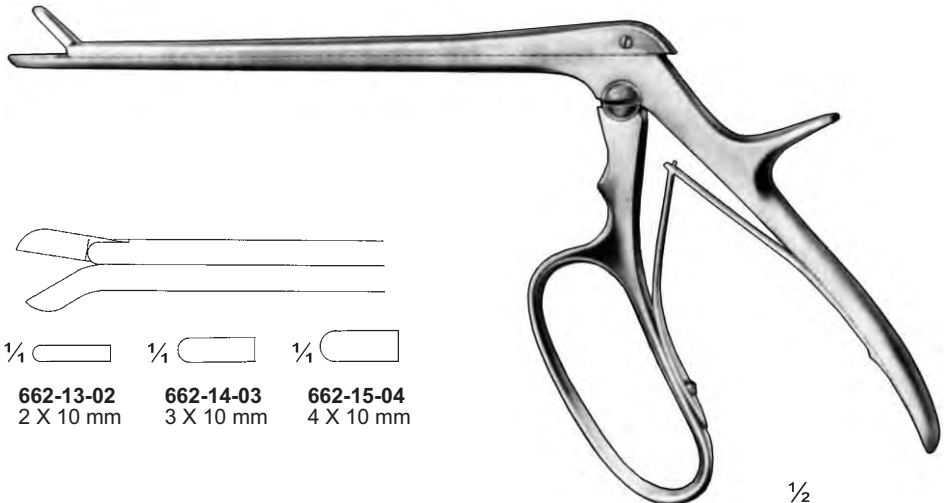

1/2

Ferris-Smith-Cushing
662-05-02 To 662-15-04
Shaft 18 cm / 7"

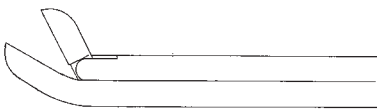

1/4

1/4

1/4

662-08-02 2 X 10 mm **662-09-03** 3 X 10 mm **662-10-04** 4 X 10 mm



1/4

1/4

1/4

662-13-02 2 X 10 mm **662-14-03** 3 X 10 mm **662-15-04** 4 X 10 mm

1/4

1/4

662-11-05 5 X 10 mm **662-12-06** 6 X 10 mm

Laminektomiezen Laminectomy Rongeurs Pincen pour laminectomie

12 cm / 4 3/4"

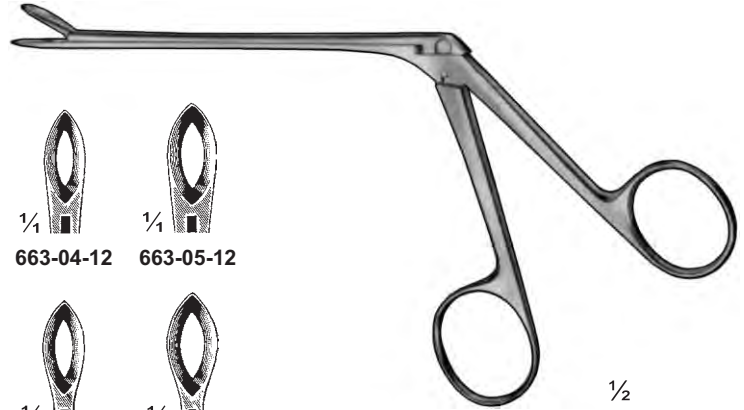

Weil-Blakesley
663-01-12 To 663-10-12
Shaft 12 cm / 4 3/4"

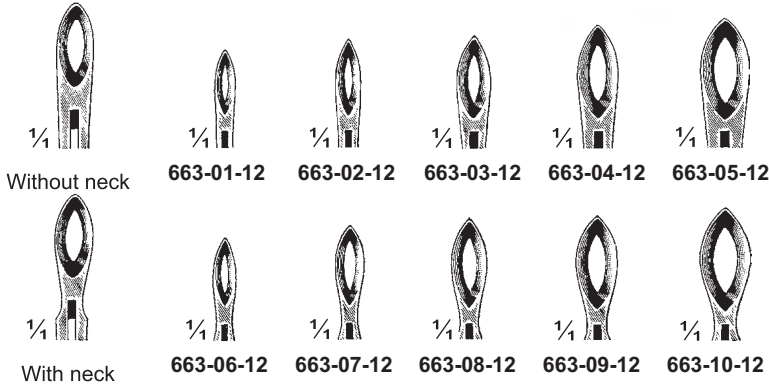

18 cm / 7"

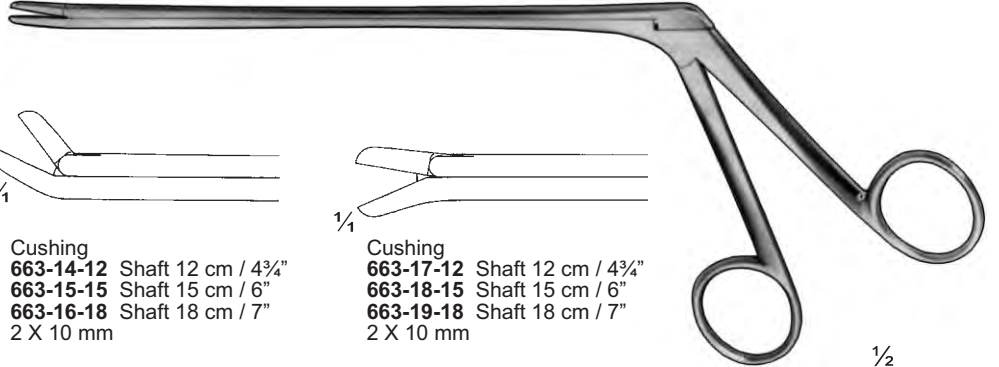

663-11-12 To 663-37-18

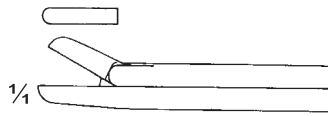

Cushing
663-11-12 Shaft 12 cm / 4 3/4"
663-12-15 Shaft 15 cm / 6"
663-13-18 Shaft 18 cm / 7"
2 X 10 mm



Cushing
663-14-12 Shaft 12 cm / 4 3/4"
663-15-15 Shaft 15 cm / 6"
663-16-18 Shaft 18 cm / 7"
2 X 10 mm



Cushing
663-17-12 Shaft 12 cm / 4 3/4"
663-18-15 Shaft 15 cm / 6"
663-19-18 Shaft 18 cm / 7"
2 X 10 mm

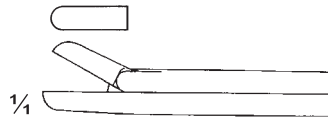

Love-Gruenwald
663-20-12 Shaft 12 cm / 4 3/4"
663-21-15 Shaft 15 cm / 6"
663-22-18 Shaft 18 cm / 7"
3 X 10 mm

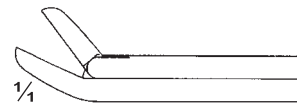

Love-Gruenwald
663-23-12 Shaft 12 cm / 4 3/4"
663-24-15 Shaft 15 cm / 6"
663-25-18 Shaft 18 cm / 7"
3 X 10 mm

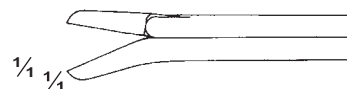

Love-Gruenwald
663-26-12 Shaft 12 cm / 4 3/4"
663-27-15 Shaft 15 cm / 6"
663-28-18 Shaft 18 cm / 7"
3 X 10 mm

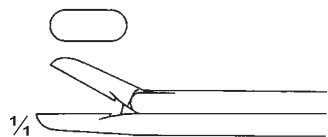

Spurling
663-29-12 Shaft 12 cm / 4 3/4"
663-30-15 Shaft 15 cm / 6"
663-31-18 Shaft 18 cm / 7"
4 X 10 mm

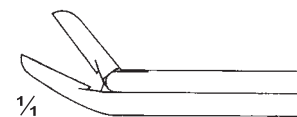

Spurling
663-32-12 Shaft 12 cm / 4 3/4"
663-33-15 Shaft 15 cm / 6"
663-34-18 Shaft 18 cm / 7"
4 X 10 mm

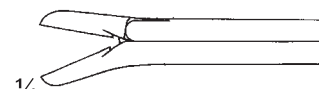

Spurling
663-35-12 Shaft 12 cm / 4 3/4"
663-36-15 Shaft 15 cm / 6"
663-37-18 Shaft 18 cm / 7"
4 X 10 mm

Laminektomie­zangen Laminectomy Rongeurs Pinces pour laminectomie

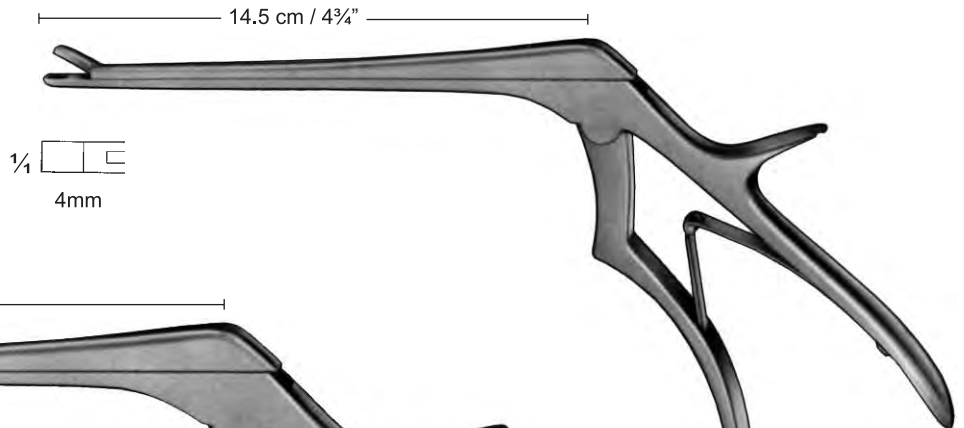

1/2
Caspar
664-01-04
Shaft 14.5 cm / 5 3/4"

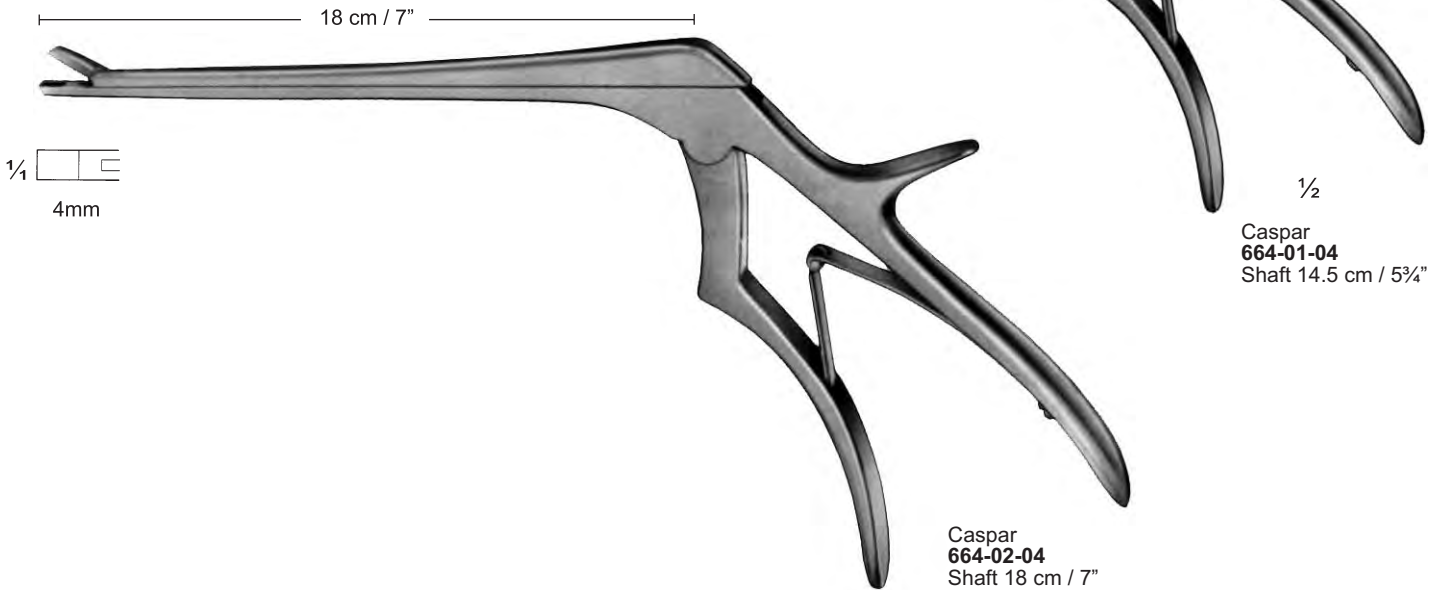

Caspar
664-02-04
Shaft 18 cm / 7"

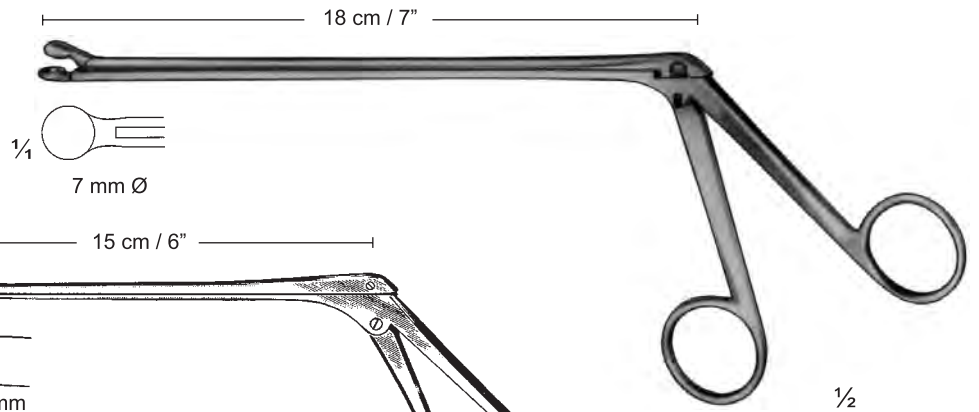

1/2
Oldberg
664-03-07
Shaft 18 cm / 7"

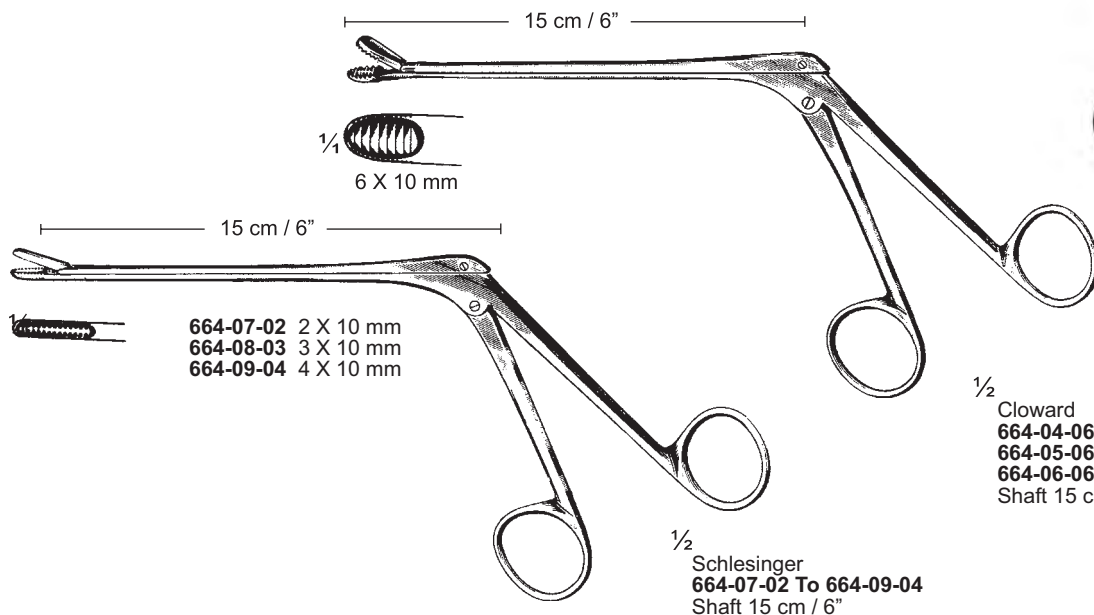

664-07-02 2 X 10 mm
664-08-03 3 X 10 mm
664-09-04 4 X 10 mm

1/2
Cloward
664-04-06 Str
664-05-06 Upward
664-06-06 Downward
Shaft 15 cm / 6"

1/2
Schlesinger
664-07-02 To 664-09-04
Shaft 15 cm / 6"

**Laminektomie­zangen
Laminectomy Rongeurs
Pinc­es pour laminec­tomie**

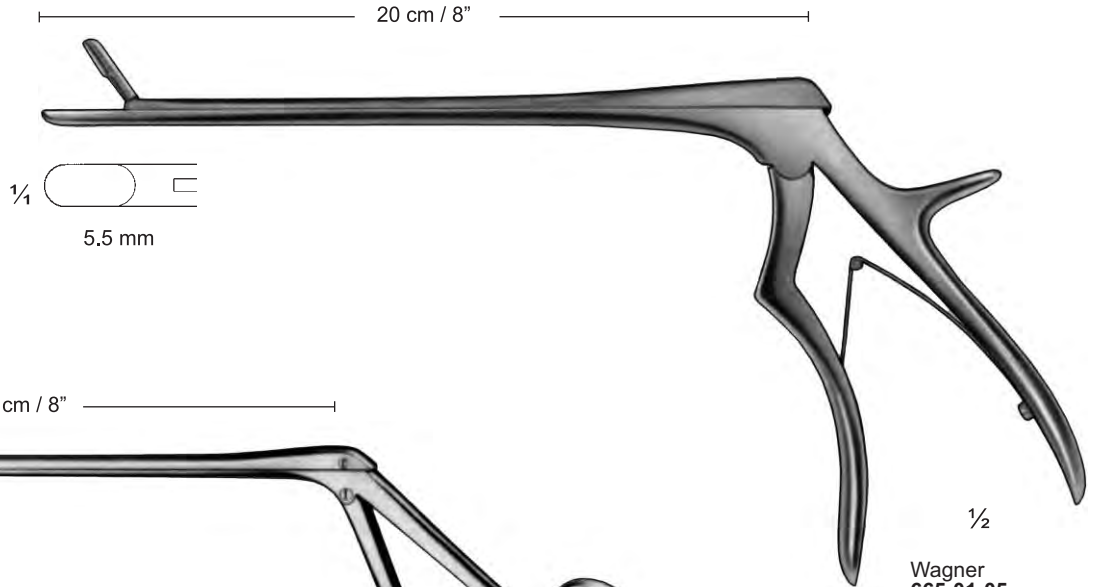

**Wagner
665-01-05**
Shaft 20 cm / 8"
Heavy pattern

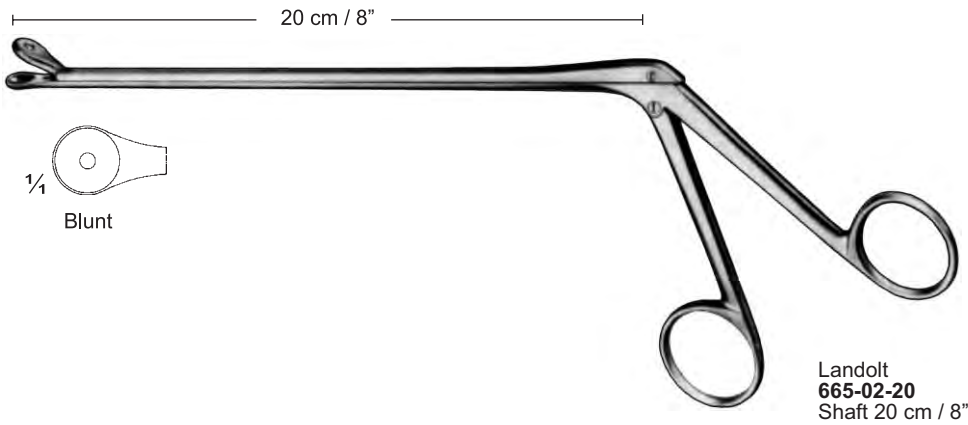

**Landolt
665-02-20**
Shaft 20 cm / 8"

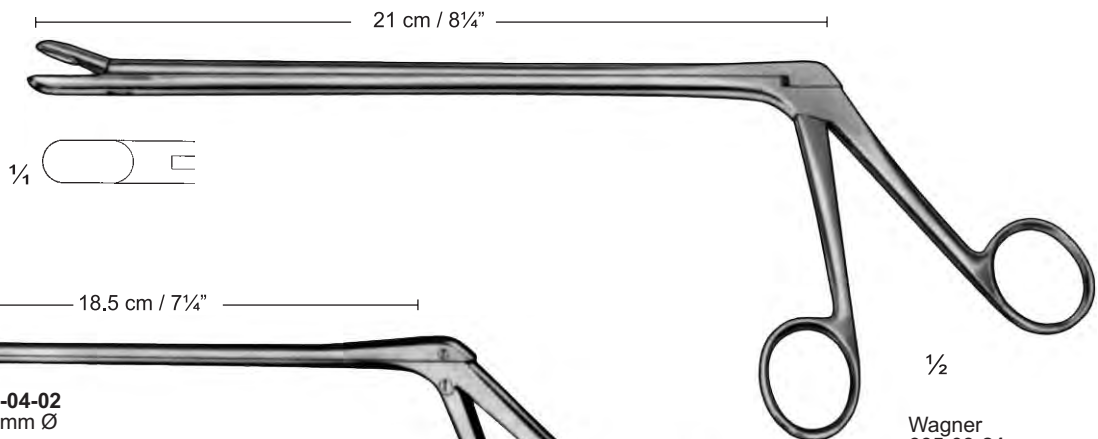

**Wagner
665-03-21**
Shaft 21 cm / 8 1/4"
Heavy pattern

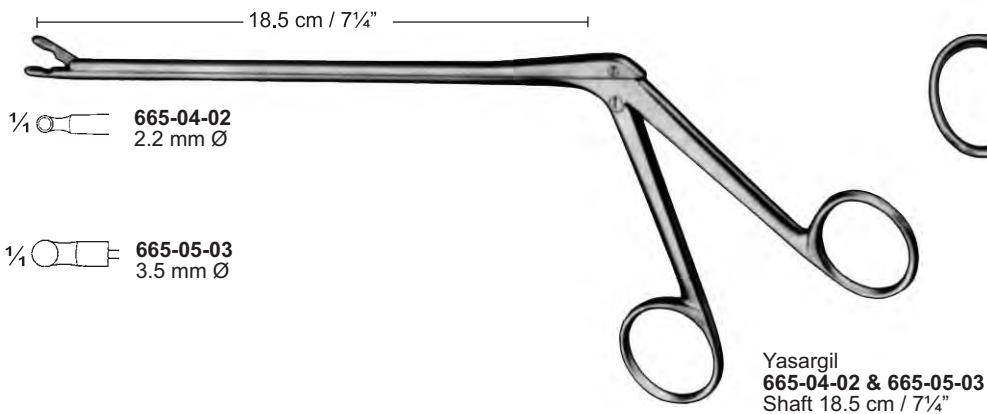

**Yasargil
665-04-02 & 665-05-03**
Shaft 18.5 cm / 7 1/4"

Laminektomie­zangen
Laminectomy Rongeurs
Pinces pour laminectomie

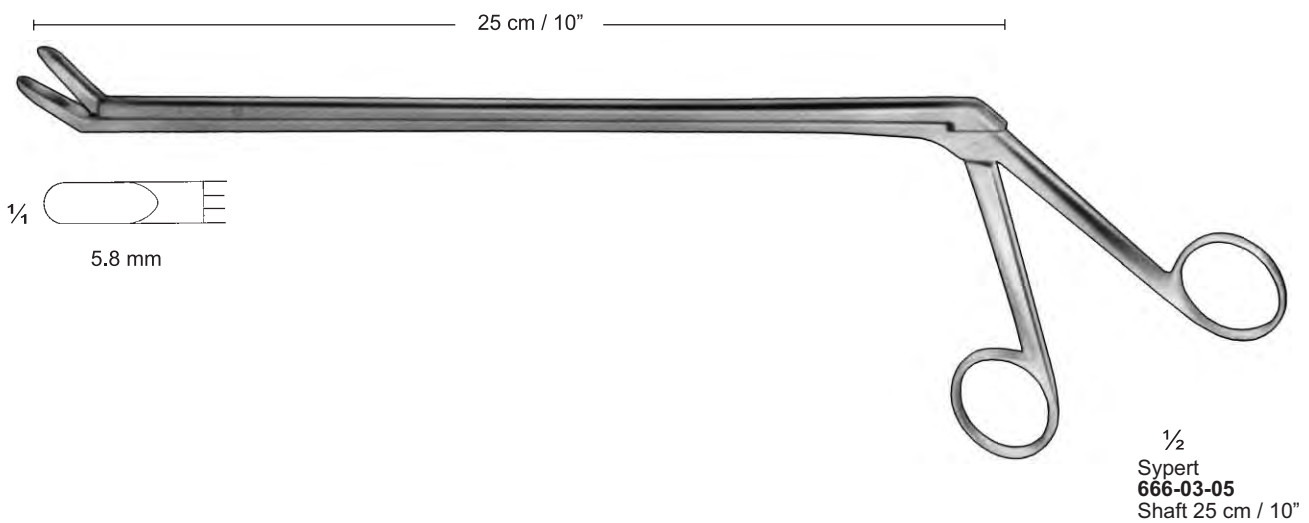
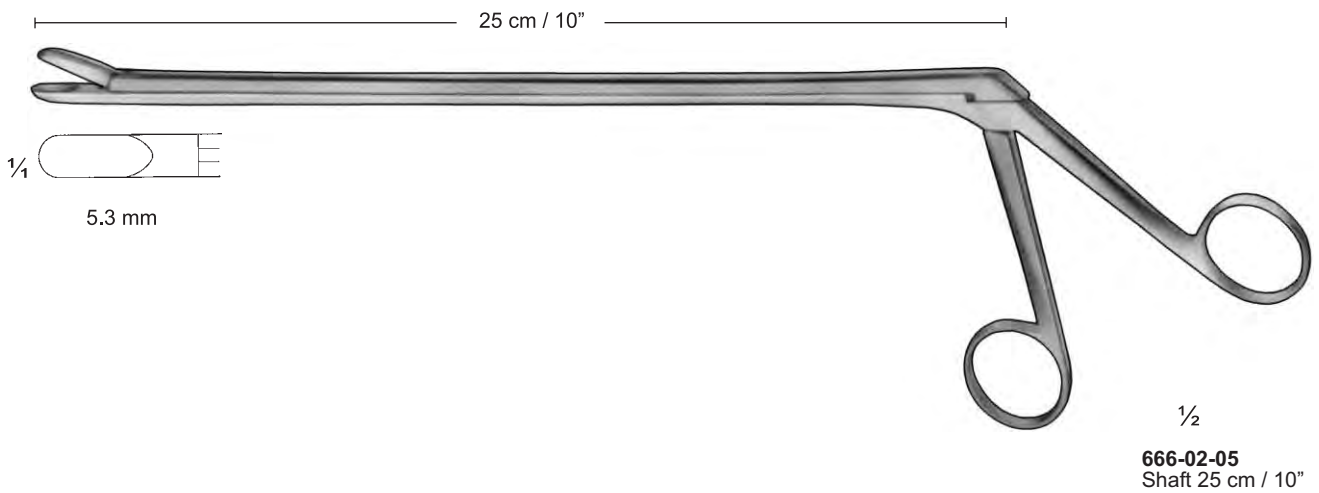
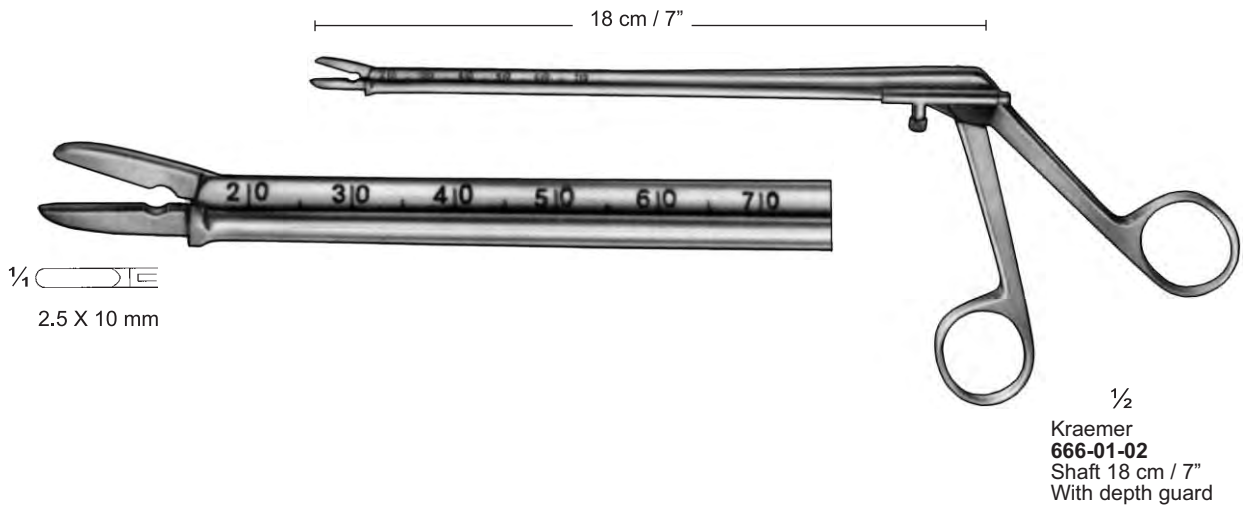

Laminektomiezingen Laminectomy Rongeurs Pinces pour laminectomie

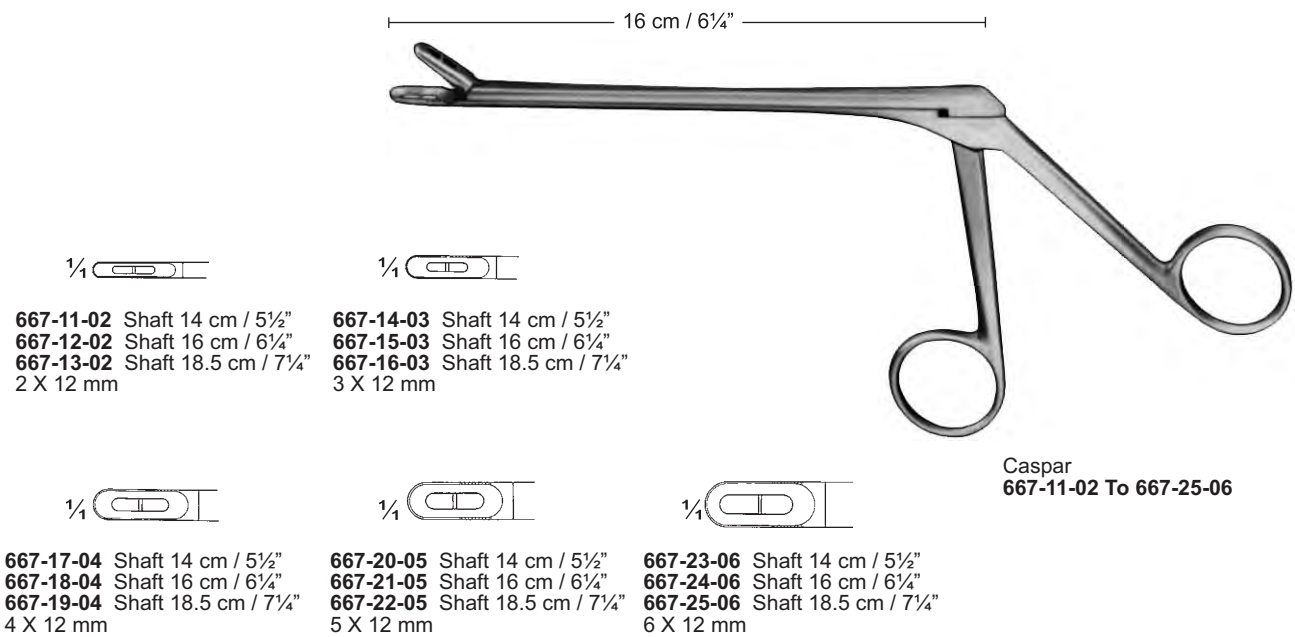
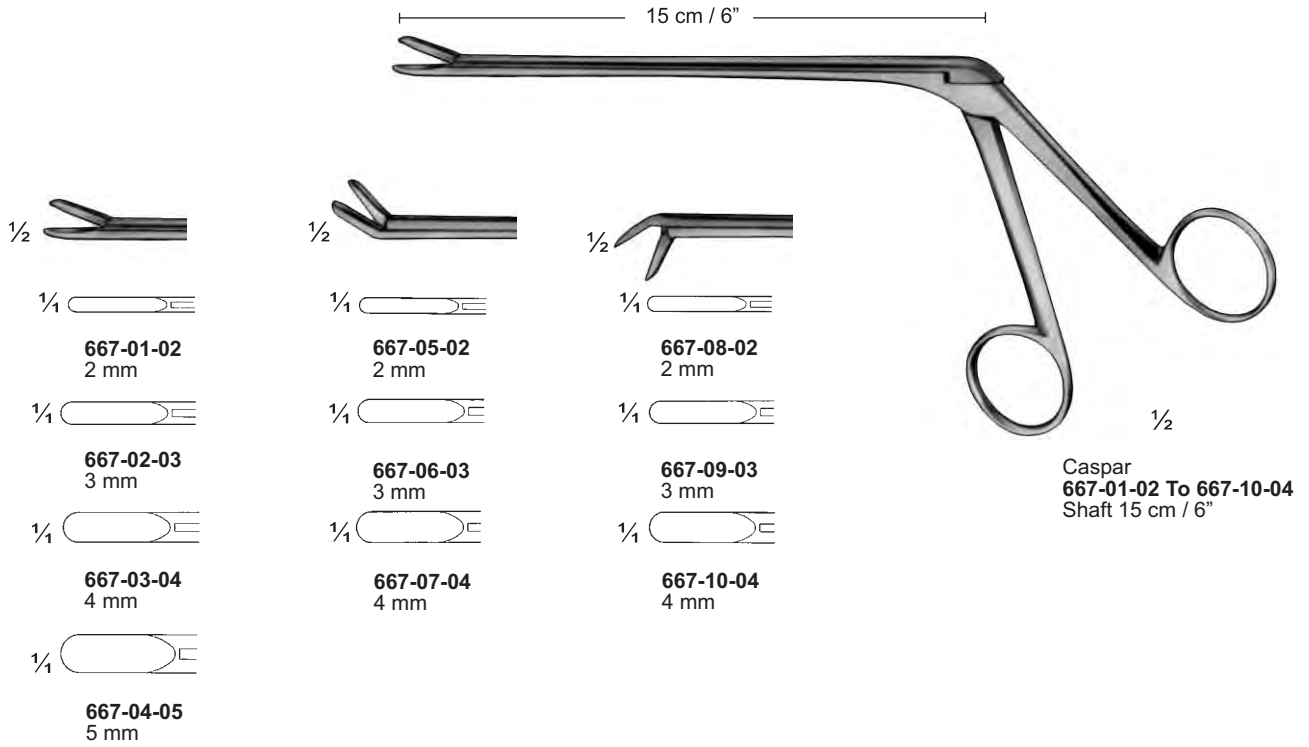

Laminektomiezingen Laminectomy Rongeurs Pincers pour laminectomie

16 cm / 6 1/4"

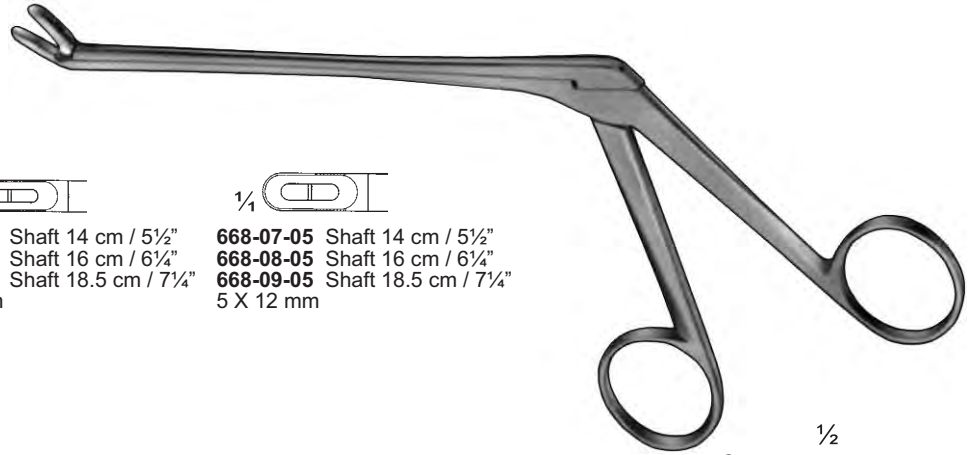

668-01-03 Shaft 14 cm / 5 1/2"
668-02-03 Shaft 16 cm / 6 1/4"
668-03-03 Shaft 18.5 cm / 7 1/4"
3 X 12 mm



668-04-04 Shaft 14 cm / 5 1/2"
668-05-04 Shaft 16 cm / 6 1/4"
668-06-04 Shaft 18.5 cm / 7 1/4"
4 X 12 mm

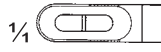

668-07-05 Shaft 14 cm / 5 1/2"
668-08-05 Shaft 16 cm / 6 1/4"
668-09-05 Shaft 18.5 cm / 7 1/4"
5 X 12 mm

1/2
Caspar
668-01-03 To 668-09-05

16 cm / 6 1/4"



668-10-03 Shaft 14 cm / 5 1/2"
668-11-03 Shaft 16 cm / 6 1/4"
668-12-03 Shaft 18.5 cm / 7 1/4"
3 X 12 mm



668-13-04 Shaft 14 cm / 5 1/2"
668-14-04 Shaft 16 cm / 6 1/4"
668-15-04 Shaft 18.5 cm / 7 1/4"
4 X 12 mm

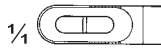

668-16-05 Shaft 14 cm / 5 1/2"
668-17-05 Shaft 16 cm / 6 1/4"
668-18-05 Shaft 18.5 cm / 7 1/4"
5 X 12 mm

1/2
Caspar
668-10-03 To 668-18-05



668-19-00 & 668-20-00



Steinhauser
669-01-15
15 cm / 6"

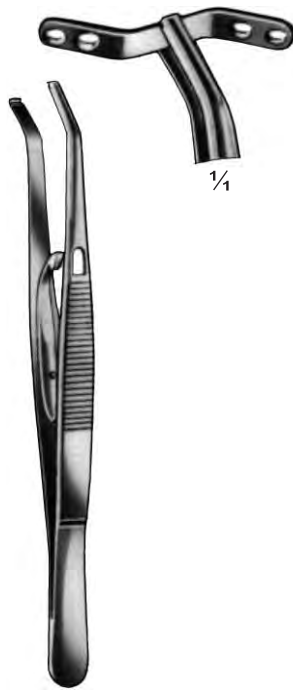

Steinhauser
669-02-13
13.5 cm / 5 1/4"



Steinhauser
669-03-14
14 cm / 5 1/2"

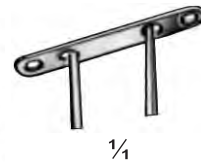

Steinhauser
669-04-15
15 cm / 6"
2.7 mm Ø



669-05-09
9 cm / 3 1/2"
1.5 mm Ø



669-06-20
20 cm / 8"



Steinhauser
669-07-23
23 cm / 9"
5 mm Ø

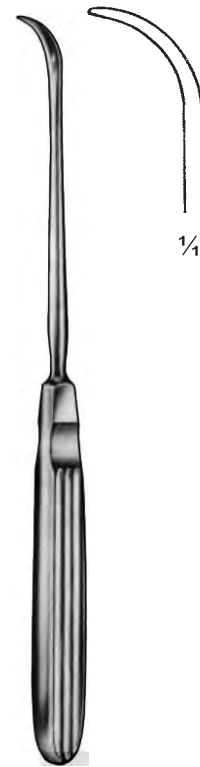

Steinhauser
669-08-19
19.5 cm / 7 3/4"



Steinhauser
669-09-18
18 cm / 7"

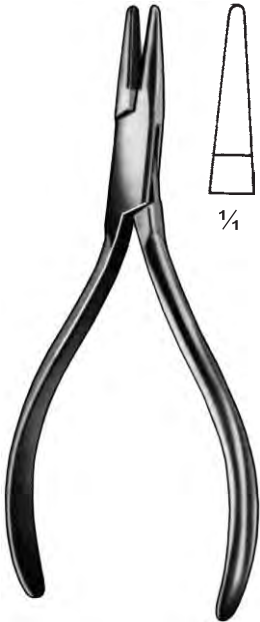

670-01-13
13 cm / 5 $\frac{1}{8}$ "
With tungsten carbide
inserts

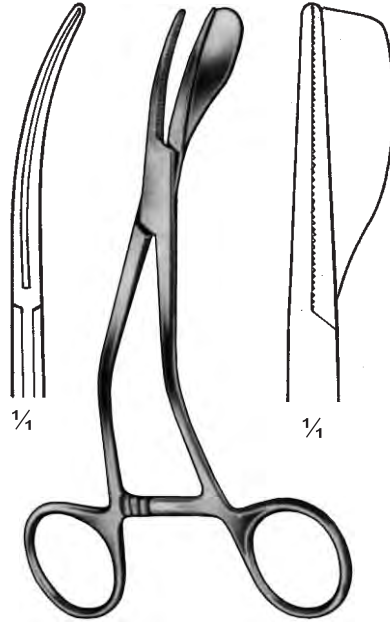

Steinhauser
670-02-14
14 cm / 5 $\frac{1}{2}$ "
Right

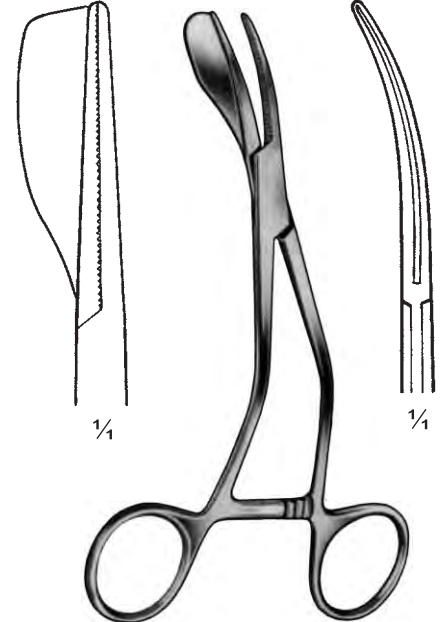

Steinhauser
670-03-14
14 cm / 5 $\frac{1}{2}$ "
Left



Steinhauser
670-04-13
13 cm / 5 $\frac{1}{8}$ "



Steinhauser
670-05-23
23.5 cm / 9 $\frac{1}{4}$ "
Left



Steinhauser
670-06-23
23.5 cm / 9 $\frac{1}{4}$ "
Right

Ohrkatheter, Polypenschnürer, Ohrpinzetten

Ear Catheters, Polypus Snares, Ear Forceps

Sondes auriculaires, Serre-noeuds, Pinces auriculaires



1/2
Krause
671-01-17
17 cm / 6 3/4"



1/2
Krause-Voss
671-02-17
17 cm / 6 3/4"

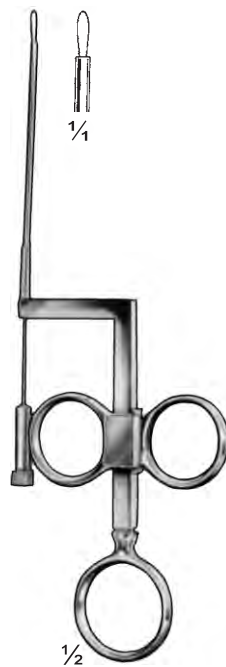

1/2
Lange-Wilde
671-03-17
17 cm / 6 3/4"

1/4
671-04-13
Fig. 0

1/4
671-05-13
Fig. 1

1/4
671-06-13
Fig. 2

1/4
671-07-13
Fig. 3

1/4
671-08-13
Fig. 4

1/4
671-09-13
Fig. 5

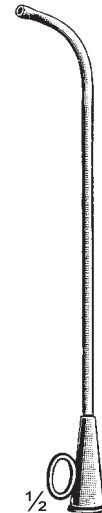

1/2
Hartmann
671-04-13 To 671-09-13
13 cm / 5 " 1/8"

1/4
671-10-16
Fig. 1

1/4
671-11-16
Fig. 2

1/4
671-12-16
Fig. 3

1/4
671-13-16
Fig. 4

1/4
671-14-16
Fig. 5

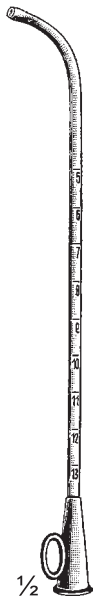

1/2
Troeltsch
671-10-16 To 671-14-16
16 cm / 6 1/4"

1/4
671-15-14
Fig. 1

1/4
671-20-15
Fig. 2
Charr. 7

1/4
671-16-14
Fig. 2

1/4
671-21-15
Fig. 3
Charr. 8

1/4
671-17-14
Fig. 3

1/4
671-22-15
Fig. 4
Charr. 9

1/4
671-18-14
Fig. 4

1/4
671-19-14
Fig. 5

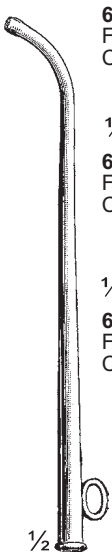

1/2
Itard
671-15-14 To 671-19-14
14 cm / 5 1/2"

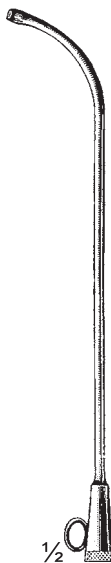

1/2
Troeltsch
671-20-15 To 671-22-15
15 cm / 6"

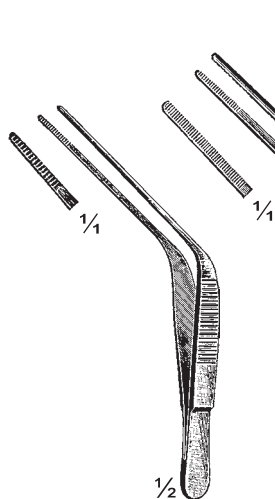

1/2
Troeltsch (Wilde)
671-23-11
11 cm / 4 1/2"



1/2
Troeltsch (Wilde)
671-24-12
12 cm / 4 3/4"

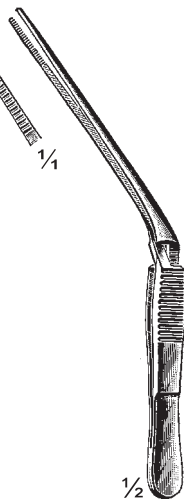

1/2
Troeltsch (Wilde)
671-25-13
13 cm / 5 1/8"



1/2
Lucae
671-26-14
14 cm / 5 1/2"

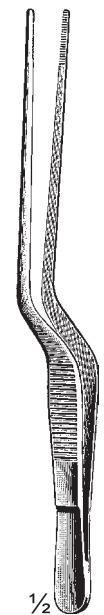

1/2
Jansen
671-27-16 16 cm / 6 1/4"
671-28-20 20 cm / 8"

Ohrpolypenzangen Ear Polypus Forceps Pincettes pour polypes auriculaires

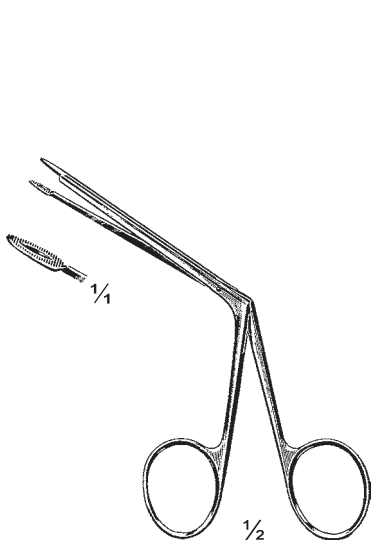

Littauer
672-01-12
12 cm / 4³/₄"

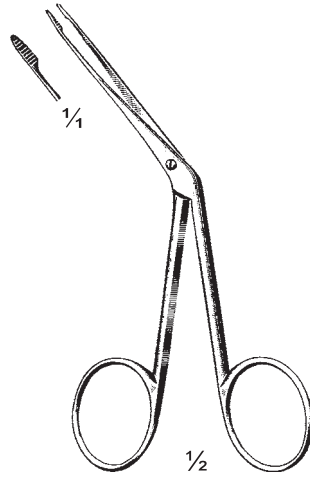

Hartmann
672-02-13
13 cm / 5¹/₈"

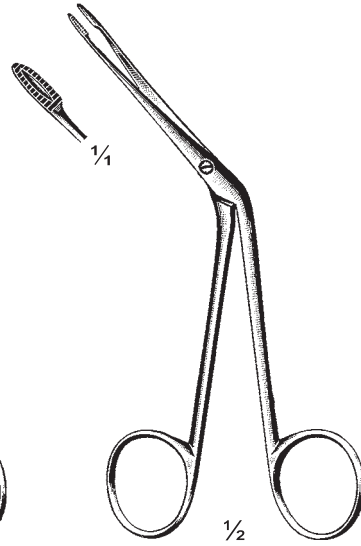

Hartmann
672-03-14
14 cm / 5¹/₂"

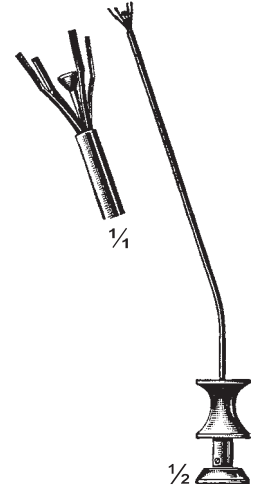

Marquet
672-04-14
14 cm / 5¹/₂"
1.5 mm Ø

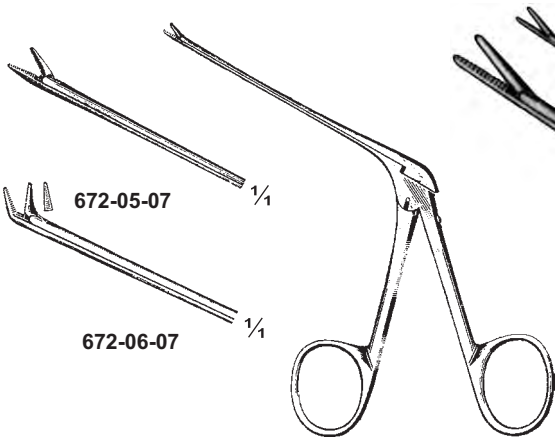

Hartmann
672-05-07 & 672-06-07
Shaft 7.4 cm / 3"



Bellucci
672-07-08
Shaft 8 cm / 3¹/₈"

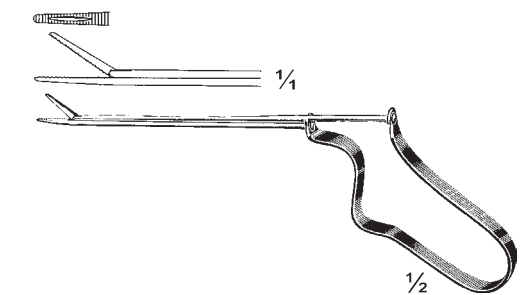

Buck
672-09-08
Shaft 8 cm / 3¹/₈"

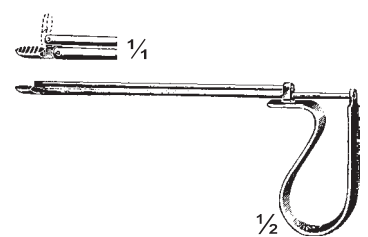

Quire
672-08-08
Shaft 8 cm / 3¹/₈"

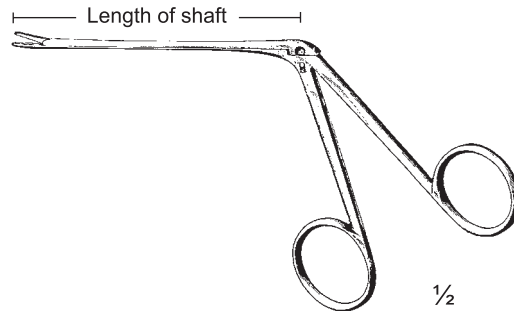

673-01-08 To 673-25-08



**Hartmann-Wullstein
673-01-08**
Shaft 8.5 cm / 3 1/4"

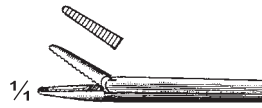

**Hartmann
673-02-08**
Shaft 8.5 cm / 3 1/4"

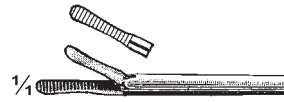

673-03-08
Shaft 8 cm / 3 1/8"

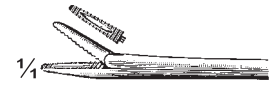

**Hartmann
673-04-08** Shaft 8.5 cm / 3 1/4"
673-05-14 Shaft 14 cm / 5 1/2"
673-06-16 Shaft 16.5 cm / 6 1/2"



**Hartmann-Noyes
673-07-09**
Shaft 9 cm / 3 1/2"



**Hartmann-Noyes
673-08-08**
Shaft 8.5 cm / 3 1/4"



**Hartmann-Weingartner
673-09-08**
Shaft 8.5 cm / 3 1/4"

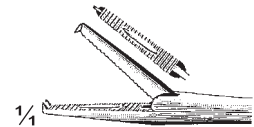

**Hartmann-Noyes
673-10-09**
Shaft 9 cm / 3 1/2"
1 X 2 Teeth



**Hartmann
673-11-08** Shaft 8.5 cm / 3 1/4"
673-12-14 Shaft 14 cm / 5 1/2"
1 X 2 Teeth

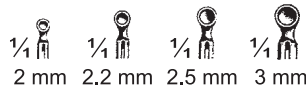

**Hartmann
673-13-08** 2 mm Ø
673-14-08 2.2 mm Ø
673-15-08 2.5 mm Ø
673-16-08 3 mm Ø
Shaft 8 cm / 3 1/8"

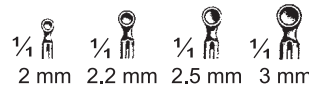

**Hartmann
673-17-08** 2 mm Ø
673-18-08 2.2 mm Ø
673-19-08 2.5 mm Ø
673-20-08 3 mm Ø
Shaft 8 cm / 3 1/8"



**Hartmann-Wullstein
673-21-08**
Shaft 8.5 cm / 3 1/4"
1 mm Ø

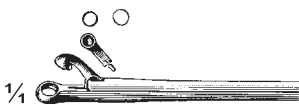

**Hartmann
673-22-08**
Shaft 8.5 cm / 3 1/4"
2 mm Ø



**Struempel
673-23-08**
Shaft 8.5 cm / 3 1/4"



**Hartmann
673-24-08**
Shaft 8.5 cm / 3 1/4"



**Hartmann
673-25-08**
Shaft 8.5 cm / 3 1/4"

Mikro-Ohrzängchen Micro Ear Forceps Micro Pincers auriculaires



674-01-08
0.5 X 4 mm
Str, Smooth



674-02-08
0.5 X 4 mm
Str, Serr



674-03-08
0.5 X 8 mm
Str, Serr



674-04-08
0.5 X 3 mm
Curved up, Serr



674-05-08
0.5 X 3 mm
Right, Serr



674-06-08
0.5 X 3 mm
Left, Serr



674-01-08 To 674-06-08
Shaft 8 cm / 3"



0.6 mm
4 mm



674-07-08 0.6 X 4 mm
674-08-08 0.8 X 4 mm
Str, Serr



674-09-08 0.6 X 3 mm
674-10-08 0.8 X 4 mm
Curved up, Serr



674-07-08 To 674-14-08
Shaft 8 cm / 3 1/8"

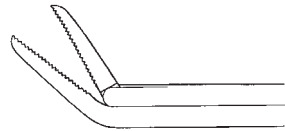

0.6 mm
3 mm



674-11-08 0.6 X 3 mm
674-12-08 0.8 X 4 mm
Right, Serr

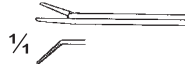

674-13-08 0.6 X 3 mm
674-14-08 0.8 X 4 mm
Left, Serr

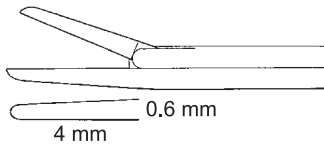

0.6 mm
4 mm



674-15-08
0.6 X 4 mm
Str, Smooth



674-15-08
Shaft 8 cm / 3 1/8"

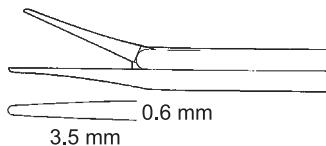

0.6 mm
3.5 mm



674-16-08
0.6 X 3.5 mm
Str, Smooth

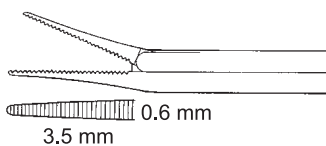

0.6 mm
3.5 mm



674-17-08
0.6 X 3.5 mm
Str, Serr



Mini McGee Alligator
674-16-08 & 674-17-08
Shaft 8 cm / 3 1/8"

Mikro-Ohrzangchen
Micro Ear Forceps
Micro Pincers auriculaires

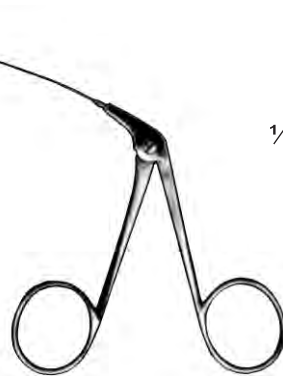
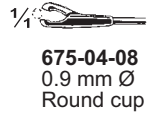
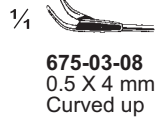
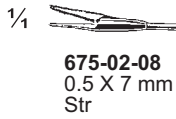
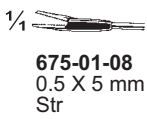

675-01-08 To 675-05-08
 Shaft 8 cm / 3 1/8"
 0.9 mm Ø

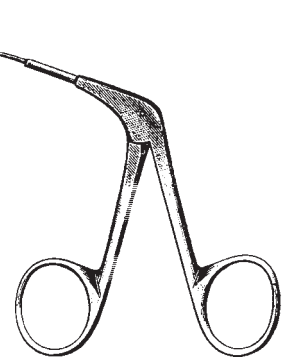
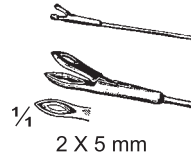

Wullstein-Blakesley
675-06-08
 Shaft 8 cm / 3 1/8"

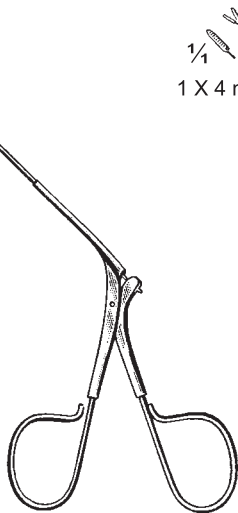

675-07-07
 Shaft 7.5 cm / 3"
 1 mm Ø

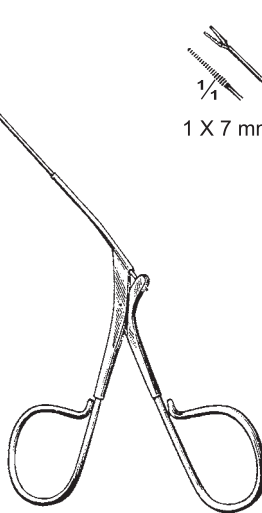
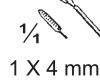

675-08-07
 Shaft 7.5 cm / 3"
 1 mm Ø

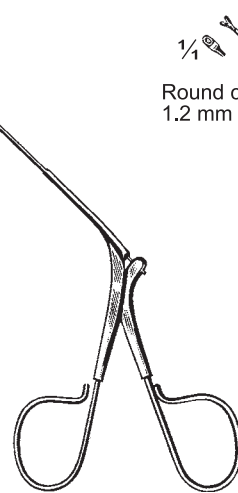

675-09-07
 Shaft 7.5 cm / 3"
 1 mm Ø

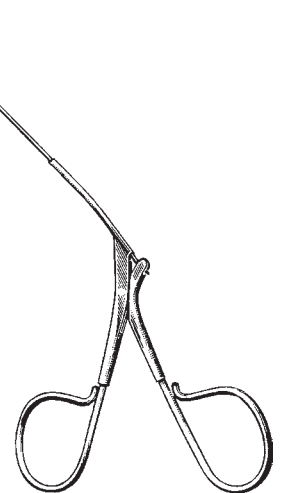

675-10-07
 Shaft 7.5 cm / 3"
 1 mm Ø

Mikro-Ohrzangchen, Mikro-Ohrscherchen
Micro Ear Forceps, Micro Ear Scissors
Micro Pinces auriculaires, Micro Ciseaux auriculaires

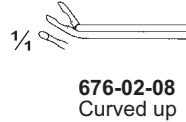
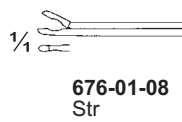
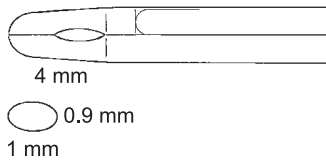

676-01-08 To 676-04-08
 Shaft 8 cm / 3 1/8"
 Oval cup 0.9 X 1 mm
 Jaw length 4 mm

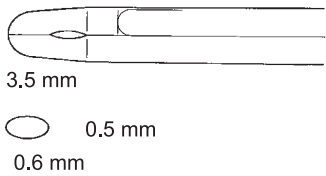
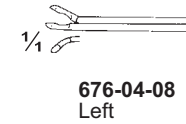
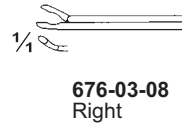

676-05-08 To 676-08-08
 Shaft 8 cm / 3 1/8"
 Oval cup 0.5 X 0.6 mm
 Jaw length 3.5 mm

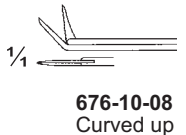
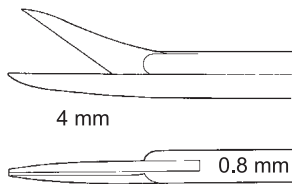

Bellucci
676-09-08 To 676-12-08
 Shaft 8 cm / 3 1/8"
 Blade length 4 mm
 Very delicate

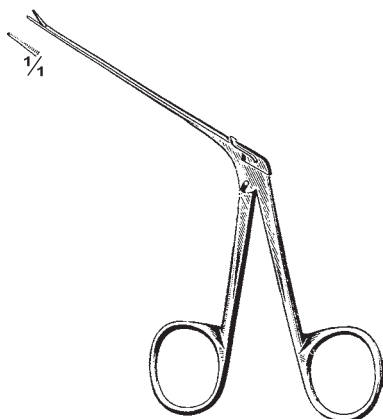
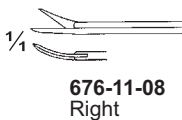

676-13-08
 Shaft 8 cm / 3 1/8"
 Jaw 0.4 X 4 mm
 Str

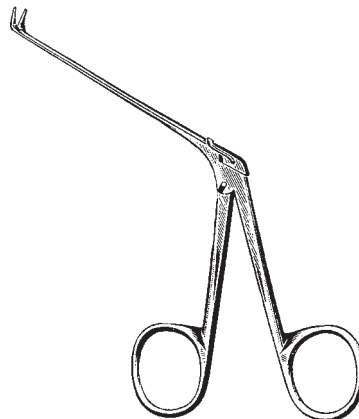

676-14-08
 Shaft 8 cm / 3 1/8"
 Jaw 0.4 X 4 mm
 Curved up

Mikro-Ohrzangchen, Mikro-Ohrscherchen
Micro Ear Forceps, Micro Ear Scissors
Micro Pinces auriculaires, Micro Ciseaux auriculaires



677-01-08
4 mm
Str, Sh/Bl



677-02-08
4 mm
Str, Sh/Sh



677-03-08
4 mm
Curved up
Sh/Sh



677-04-08
4 mm
Right
Sh/Sh

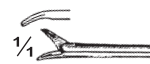

677-05-08
4 mm
Left
Sh/Sh

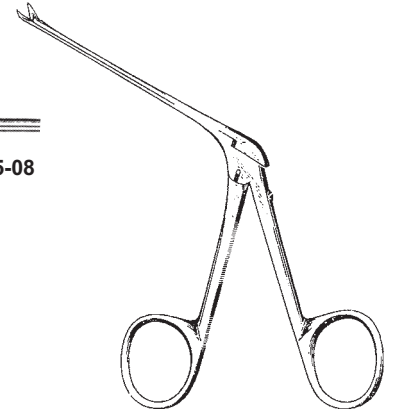

Bellucci
677-01-08 To 677-05-08
Shaft 8 cm / 3 1/8"

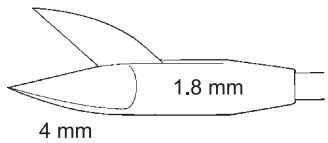

4 mm

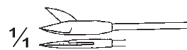

677-06-08
Str



677-07-08
Curved up



1 mm



677-08-08
Right

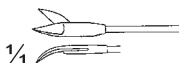

677-09-08
Left



1/2

Wullstein
677-06-08 To 677-09-08
Shaft 8 cm / 3 1/8"
Shaft 0.8 mm Ø
Blade length 4 mm



677-10-08
Str, Bl/Bl



677-11-08
Str, Sh/Sh



677-12-08
Right



677-13-08
Left

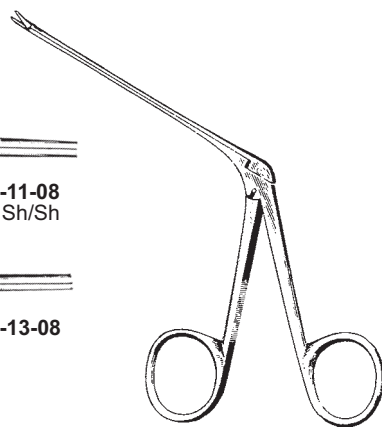

Shea-Bellucci
677-10-08 To 677-13-08
Shaft 8 cm / 3 1/8"
Blade length 8 mm



677-14-08
Str



677-15-08
Curved up



677-16-08
Right



677-17-08
Left

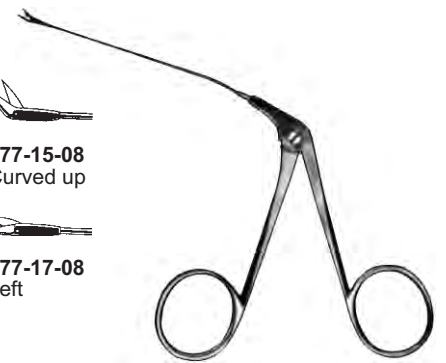

677-14-08 To 677-17-08
Shaft 8 cm / 3 1/8"
Shaft 0.9 mm Ø
Blade length 4 mm

Mikro-Ohrzangchen
Micro Ear Forceps
Micro Pincers auriculaires

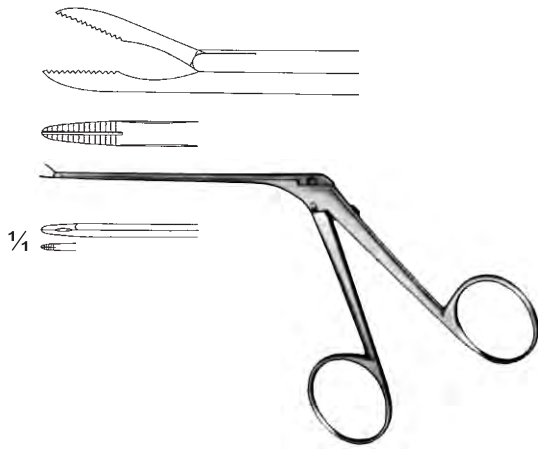

Greven
678-01-08
 Shaft 8 cm / 3 1/8"

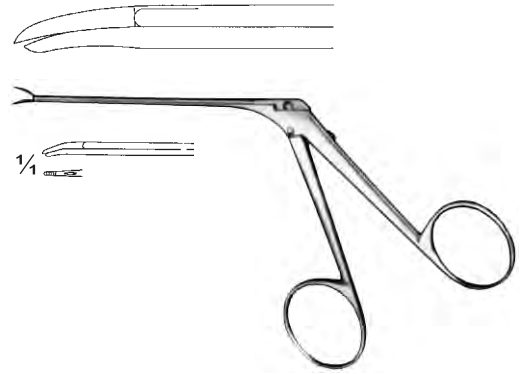

Schuknecht
678-02-08
 Shaft 8 cm / 3 1/8"

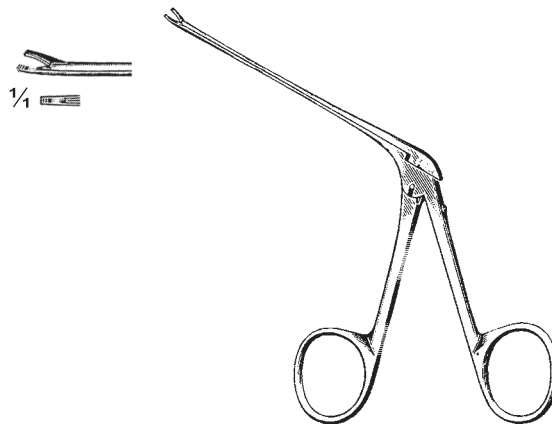

Greven
678-03-08
 Shaft 8 cm / 3 1/8"

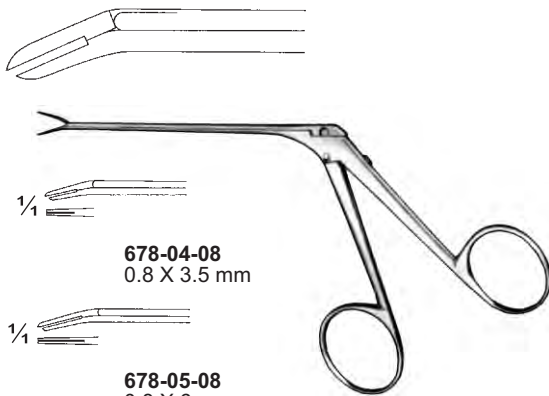

678-04-08
 0.8 X 3.5 mm

678-05-08
 0.8 X 6 mm

McGee
678-04-08 & 678-05-08
 Shaft 8 cm / 3 1/8"

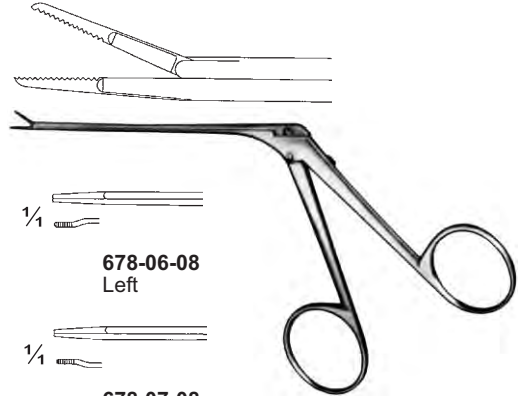

678-06-08
 Left

678-07-08
 Right

Juers
678-06-08 & 678-07-08
 Shaft 8 cm / 3 1/8"

Mikro-Ohrzängchen Micro Ear Forceps Micro Pincettes auriculaires

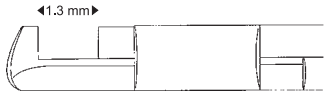

1/4
679-01-08

1/4
679-02-08

1/4
679-03-08
Left

1/4
679-04-08
Right

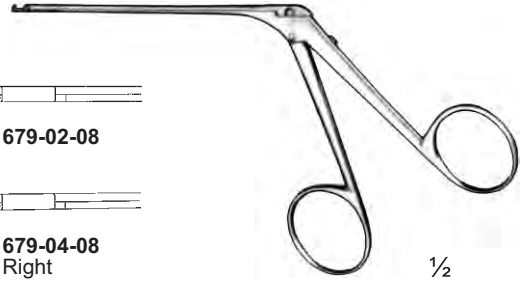

1/2
House-Dieter
679-01-08 To 679-04-08
Shaft 8 cm / 3 1/8"

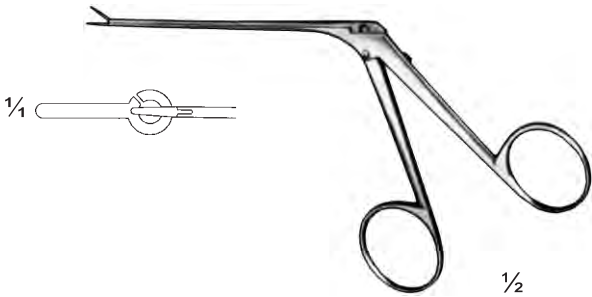

1/2
Fuller
679-05-08
Shaft 8 cm / 3 1/8"
Instrument for introducing
taflon pistons

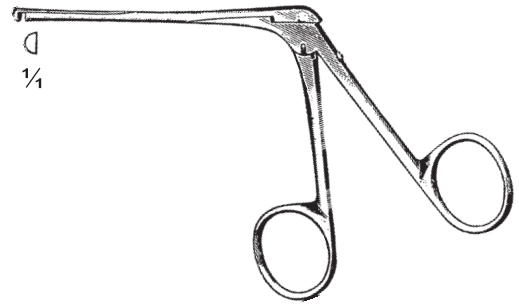

1/4
Davol
679-06-08
Shaft 8 cm / 3 1/8"

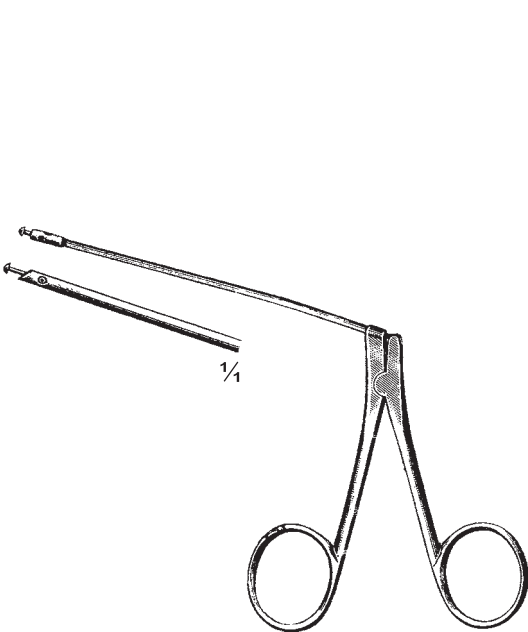

1/4
Mehmke
679-07-09
Shaft 9 cm / 3 1/2"

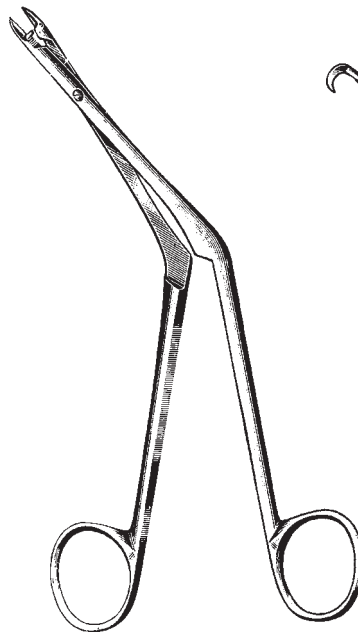

Wullstein
679-08-08
Shaft 8 cm / 3 1/8"

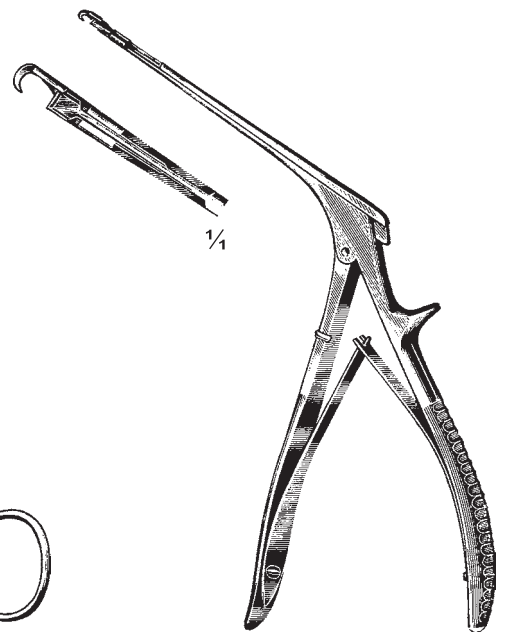

1/4
Lempert
679-09-09
Shaft 9.5 cm / 3 3/4"

$\frac{1}{4}$ ○
680-01-02
No. 1
2.5 mm Ø

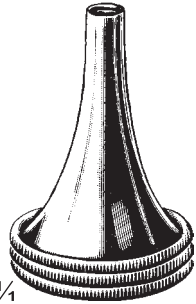

Hartmann
680-01-02 To 680-06-06
680-07-03 Set of 3 (680-01-02 To 680-03-05)
680-08-03 Set of 3 (680-04-03 To 680-06-06)

$\frac{1}{4}$ ○
680-04-03
No. 0
3 mm Ø

$\frac{1}{4}$ ○
680-02-04
No. 2
4 mm Ø

$\frac{1}{4}$ ○
680-05-04
No. 1
4.5 mm Ø

$\frac{1}{4}$ ○
680-03-05
No. 3
5 mm Ø

$\frac{1}{4}$ ○
680-06-06
No. 2
6.5 mm Ø

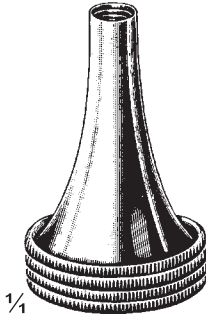

Hartmann
680-09-04 To 680-12-07
680-13-03 Set of 3 (680-10-05 To 680-12-07)
680-14-04 Set of 4 (680-09-04 To 680-12-07)

$\frac{1}{4}$ ○
680-09-04
No. 1
4.5 mm Ø

$\frac{1}{4}$ ○
680-10-05
No. 2
5.5 mm Ø

$\frac{1}{4}$ ○
680-11-06
No. 3
6.5 mm Ø

$\frac{1}{4}$ ○
680-12-07
No. 4
7.5 mm Ø

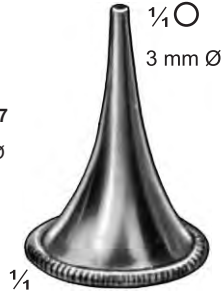

Hartmann
680-15-03

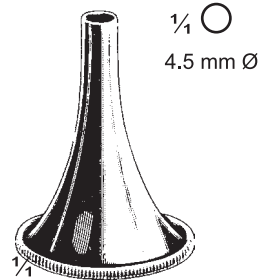

Hartmann
680-16-04
For infants



Toynbee
680-17-04 To 680-20-07
680-21-03 Set of 3 (680-18-05 To 680-20-07)
680-22-04 Set of 4 (680-17-04 To 680-20-07)

$\frac{1}{4}$ ○
680-17-04
680-23-04
No. 1
4.5 mm Ø

$\frac{1}{4}$ ○
680-18-05
680-24-05
No. 2
5.5 mm Ø

$\frac{1}{4}$ ○
680-19-06
680-25-06
No. 3
6.5 mm Ø

$\frac{1}{4}$ ○
680-20-07
680-26-07
No. 4
7.5 mm Ø

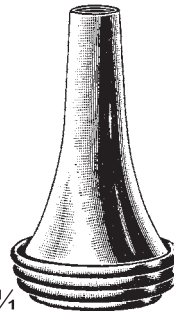

Toynbee
680-23-04 To 680-26-07
680-27-04
Set of 4 (680-23-04 To 680-26-07)

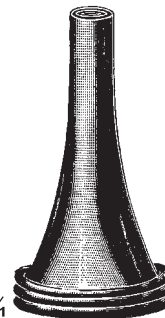

Politzer
680-28-03 To 680-31-06
680-32-03 Set of 3 (680-28-03 To 680-30-05)
680-33-04 Set of 4 (680-28-03 To 680-31-06)

$\frac{1}{4}$ ○
680-28-03
No. 1
3 mm Ø

$\frac{1}{4}$ ○
680-29-04
No. 2
4.5 mm Ø

$\frac{1}{4}$ ○
680-30-05
No. 3
5.5 mm Ø

$\frac{1}{4}$ ○
680-31-06
No. 4
6.5 mm Ø

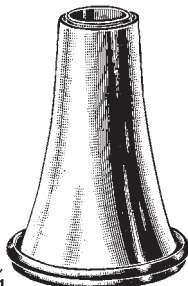

Hartmann
680-34-09 & 680-35-11
680-36-02
Set of 2 (680-34-09 & 680-35-11)

$\frac{1}{4}$ ○
680-34-09
No. 1
9 mm Ø

$\frac{1}{4}$ ○
680-35-11
No. 2
11 mm Ø

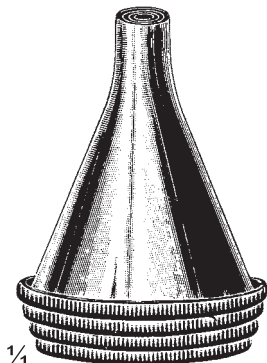

Boucheron
680-37-04 To 680-40-07
680-41-04
Set of 4 (680-37-04 To 680-40-07)

$\frac{1}{4}$ ○
680-37-04
No. 1
4.5 mm Ø

$\frac{1}{4}$ ○
680-38-05
No. 2
5.5 mm Ø

$\frac{1}{4}$ ○
680-39-06
No. 3
6.5 mm Ø

$\frac{1}{4}$ ○
680-40-07
No. 4
7.5 mm Ø

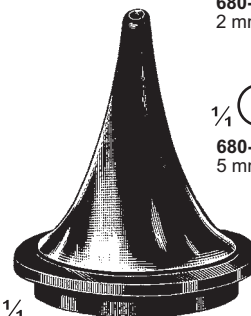

680-42-02 To 680-47-07
680-48-06
Set of 6 (680-42-02 To 680-47-07)

$\frac{1}{4}$ ○
680-42-02
2 mm Ø

$\frac{1}{4}$ ○
680-43-03
3 mm Ø

$\frac{1}{4}$ ○
680-44-04
4 mm Ø

$\frac{1}{4}$ ○
680-45-05
5 mm Ø

$\frac{1}{4}$ ○
680-46-06
6 mm Ø

$\frac{1}{4}$ ○
680-47-07
7.5 mm Ø

1/4 ○
681-01-03
No. 1
3 mm Ø



1/4 ○
681-02-04
No. 2
4 mm Ø

1/4 ○
681-03-05
No. 3
5 mm Ø

Troeltsch
681-01-03 To 681-03-05
681-04-03
Set of 3 (681-01-03 To 681-03-05)

1/4 ○
681-05-06
No. 1
6 mm Ø

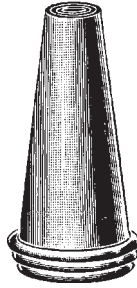

1/4 ○
681-06-07
No. 2
7 mm Ø

1/4 ○
681-07-08
No. 3
8 mm Ø

Troeltsch
681-05-06 To 681-07-08
681-08-03
Set of 3 (681-05-06 To 681-07-08)

1/4 ○
681-09-04
No. 1
4.5 mm Ø



1/4 ○
681-10-05
No. 2
5.5 mm Ø

1/4 ○
681-11-06
No. 3
6.5 mm Ø

1/4 ○
681-12-07
No. 4
7.5 mm Ø

Gruber
681-09-04 To 681-12-07
681-13-03 Set of 3 (681-09-04 To 681-11-06)
681-14-04 Set of 4 (681-09-04 To 681-12-07)

1/4 ○
681-15-05
No. 1
5.5 X 6.5 mm



1/4 ○
681-16-06
No. 2
6.5 X 7.5 mm

1/4 ○
681-17-07
No. 3
7.5 X 8.5 mm

1/4 ○
681-18-08
No. 4
8.5 X 9.5 mm

1/4 ○
681-19-09
No. 5
9.5 X 10.5 mm

1/4 ○
681-20-10
No. 6
10.5 X 11.5 mm

Zoellner
681-15-05 To 681-20-10
681-21-06
Set of 6 (681-15-05 To 681-20-10)

1/4 ○
681-22-03
No. 1
3.5 X 4.5 mm

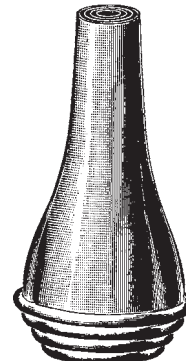

1/4 ○
681-23-04
No. 2
4.5 X 5.5 mm

1/4 ○
681-24-05
No. 3
5.5 X 6.5 mm

1/4 ○
681-25-06
No. 4
6.5 X 7.5 mm

Gruber
681-22-03 To 681-25-06
681-26-03 Set of 3 (681-22-03 To 681-24-05)
681-27-04 Set of 4 (681-22-03 To 681-25-06)



681-28-10
10 cm / 4"

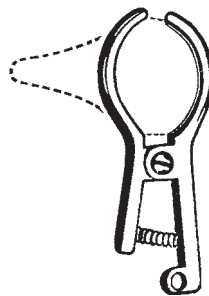

681-29-06
6 cm / 2 1/2"
Speculum holder

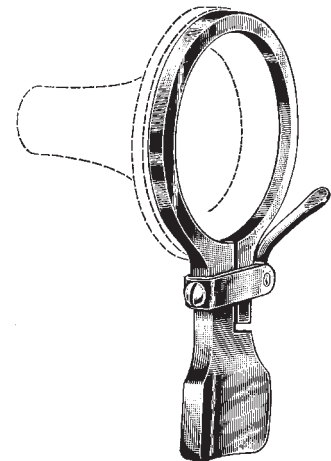

681-30-06
6 cm / 2 1/2"
Speculum holder

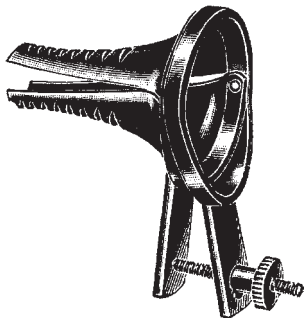

$\frac{1}{4}$
682-01-06
No. 1
6 mm Ø

Holmagren
682-01-06 & 682-02-07

$\frac{1}{4}$
682-02-07
No. 2
7 mm Ø

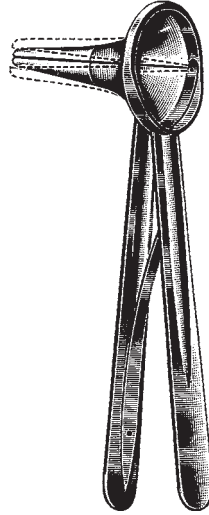

$\frac{1}{4}$
682-03-03
No. 0
3 mm Ø

Richnau-Holmgren
682-03-03 To 682-06-06

$\frac{1}{4}$
682-04-04
No. 1
4 mm Ø

$\frac{1}{4}$
682-05-05
No. 3
5 mm Ø

$\frac{1}{4}$
682-06-06
No. 4
6 mm Ø



$\frac{1}{4}$
5 mm Ø

Paparella
682-07-06
13 cm / 5 $\frac{1}{4}$ "



$\frac{1}{4}$
682-08-04
No. 1
4.5 mm Ø

$\frac{1}{4}$
682-09-05
No. 2
5.5 mm Ø

$\frac{1}{4}$
682-10-06
No. 3
6.5 mm Ø

Erhardt
682-08-04 To 682-10-06
682-11-03 Set of 3 (682-08-04 To 682-10-06)

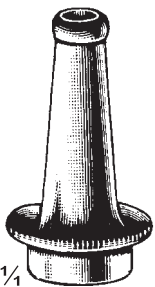

$\frac{1}{4}$
682-12-05
No. 0
5.5 mm Ø

$\frac{1}{4}$
682-13-06
No. 1
6.5 mm Ø

$\frac{1}{4}$
682-14-07
No. 2
7.5 mm Ø

$\frac{1}{4}$
682-15-08
No. 3
8.5 mm Ø

$\frac{1}{4}$
682-16-09
No. 4
9.5 mm Ø

$\frac{1}{4}$
682-17-10
No. 5
10.5 mm Ø



Bruenings
682-12-05 To 682-17-10
682-18-06 Set of 6 (682-12-05 To 682-17-10)



Bruenings
682-19-00
Complete with 4 Bruenings
specula packed in woode case

Ohrspekula, Stimmgabeln
Ear Specula, Tuning Forks
Spéculums auriculaires, Diapasons



- | | | |
|----------------------------------------------------------------------------------------------------------------------------------------|------------------------------------------------------------------------------------------------------------------------------------------|------------------------------------------------------------------------------------------------------------------------------------------|
| $\frac{1}{4}$ 
683-01-06
No. 1
6 mm Ø | $\frac{1}{4}$ 
683-02-06
No. 2
6.5 mm Ø | $\frac{1}{4}$ 
683-03-07
No. 3
7.5 mm Ø |
|----------------------------------------------------------------------------------------------------------------------------------------|------------------------------------------------------------------------------------------------------------------------------------------|------------------------------------------------------------------------------------------------------------------------------------------|

Siegle
683-01-06 To 683-03-07
683-04-03
 Set of 3 (683-01-06 To 683-03-07)

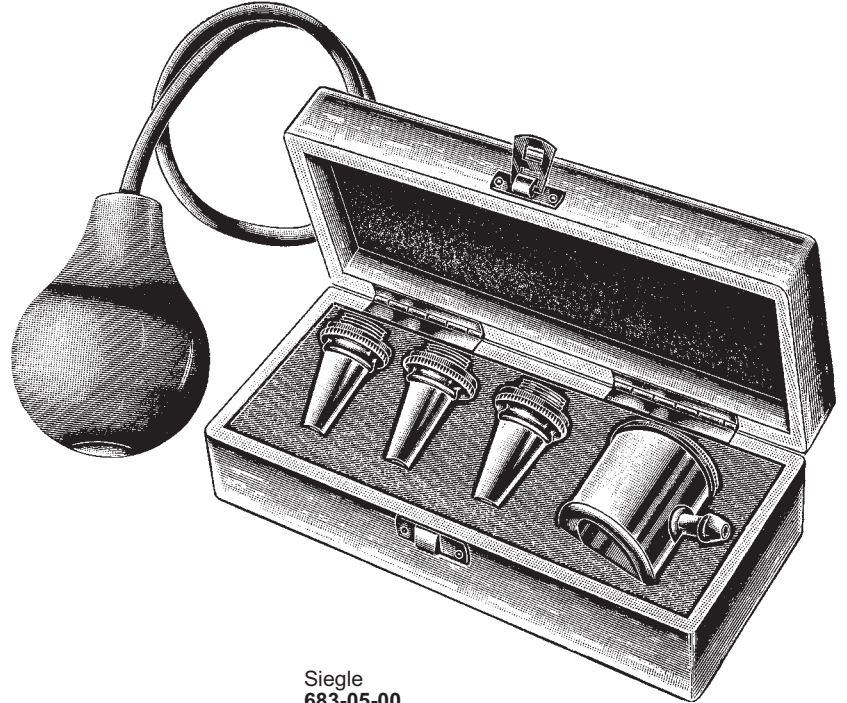

Siegle
683-05-00
 Complete set with
 3 Siegle specula packed
 in wooden case



$\frac{1}{2}$
Hartmann
683-06-128
 c 128



$\frac{1}{2}$
Hartmann
683-07-256
 c¹ 256



$\frac{1}{2}$
Hartmann
683-08-512
 c² 512



$\frac{1}{2}$
Hartmann
683-09-1024
 c³ 1024

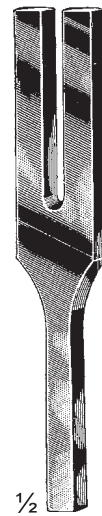

$\frac{1}{2}$
Hartmann
683-10-2048
 c 2048

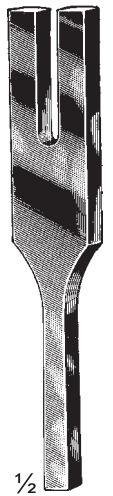

$\frac{1}{2}$
Hartmann
683-11-4096
 c⁵ 4096

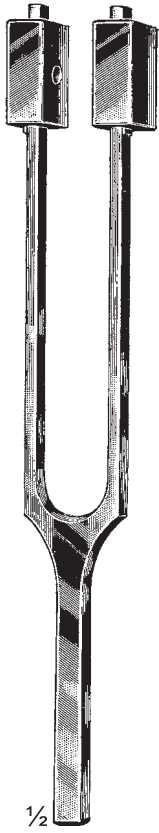

1/2

Hartmann
684-01-64
c 64



1/2

Hartmann
684-02-128
c 128



1/2

Hartmann
684-03-256
c' 256



1/2

684-04-440
a' 440



Lucae
684-05-128
c 128



Lucae
684-06-256
c' 256



Lucae
684-07-512
c² 512



Lucae
684-08-1024
c³ 1024



Lucae
684-09-2048
c⁴ 2048



Lucae
684-10-4096
c⁵ 4096

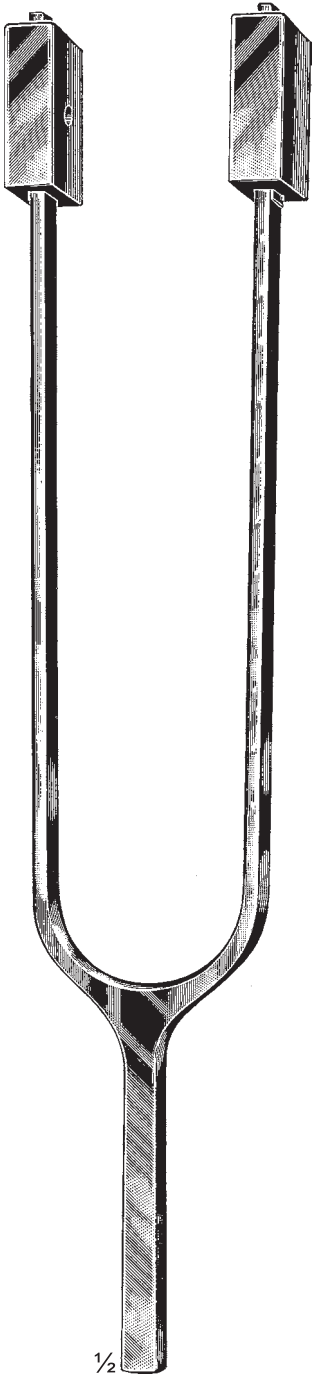

1/2

French
685-05-16
c_ 16

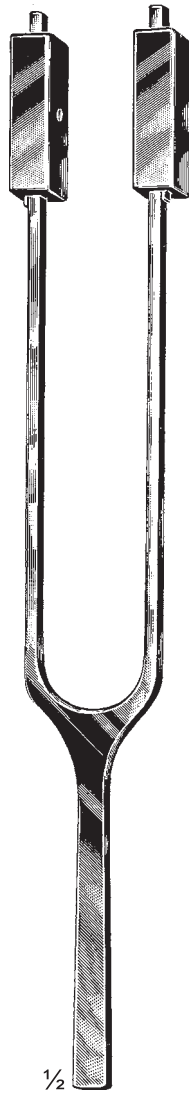

1/2

French
685-06-32
c_ 32



Alu
685-01-512
c² 512



Alu
685-02-1024
c³ 1024



Alu
685-03-2048
c 2048



Alu
685-04-4096
c 4096

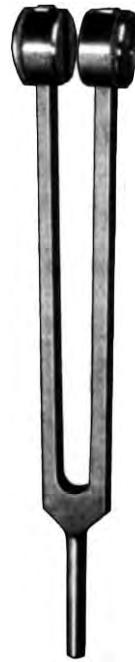

Alu
685-07-64
c 64

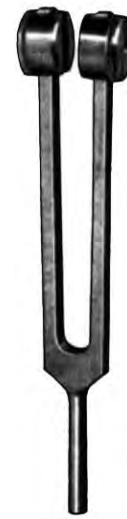

Alu
685-08-128
c 128



Alu
685-09-256
c¹ 256



Gardiner-Brown
686-01-128
c 128



Gardiner-Brown
686-02-256
c¹ 256



Gardiner-Brown
686-03-512
c² 512



Gardiner-Brown
686-04-1024
c³ 1024



Gardiner-Brown
686-05-2048
c⁴ 2048



Gardiner-Brown
686-06-435
a¹ 435

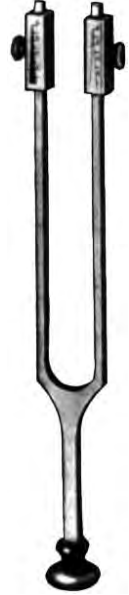

Rydel-Seiffer
686-07-128
c 64/c 128



Lucae
686-08-128
c 128

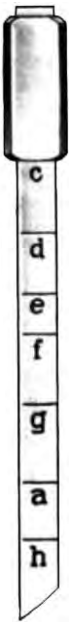

Koenig
686-09-109
a 109

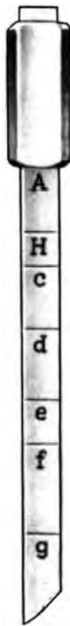

Hartmann
686-10-128
c 128

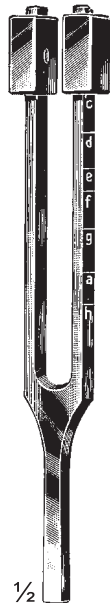

Hartmann
686-11-256
c¹ 256



686-12-00
Tuning fork for
neurology



Hartmann
687-01-05
Complete set packed in wooden case
consisting :
1 Hartmann tuning fork c 128
1 Hartmann tuning fork c¹ 256
1 Hartmann tuning fork c² 512
1 Hartmann tuning fork c³ 1024
1 Hartmann tuning fork c 2048



Hartmann
687-02-08
Complete set packed in wooden case
consisting :
1 Hartmann tuning fork c 64
1 Hartmann tuning fork c 128
1 Hartmann tuning fork c¹ 32
1 Hartmann tuning fork c¹ 256
1 Hartmann tuning fork c² 512
1 Hartmann tuning fork c³ 1024
1 Hartmann tuning fork c 2048
1 Hartmann tuning fork c 4096



Alu
687-03-05
Complete set packed in wooden case
consisting :
1 Alu tuning fork c 128
1 Alu tuning fork c¹ 256
1 Alu tuning fork c² 512
1 Alu tuning fork c³ 1024
1 Alu tuning fork c 2048

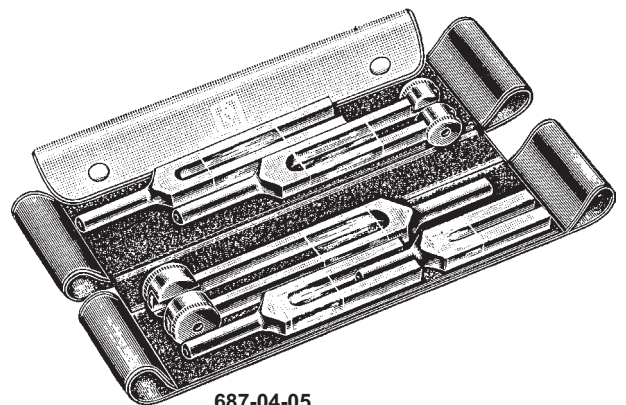

687-04-05
Complete set packed in plastic pouch
consisting :
1 Alu tuning fork c 128
1 Alu tuning fork c¹ 256
1 Alu tuning fork c² 512
1 Alu tuning fork c³ 1024
1 Alu tuning fork c 2048

Mikro-Ohrmesser, Mikro-Ohrnadeln Knives Micro Couteaux auriculaires, Micro Aghi auricolari

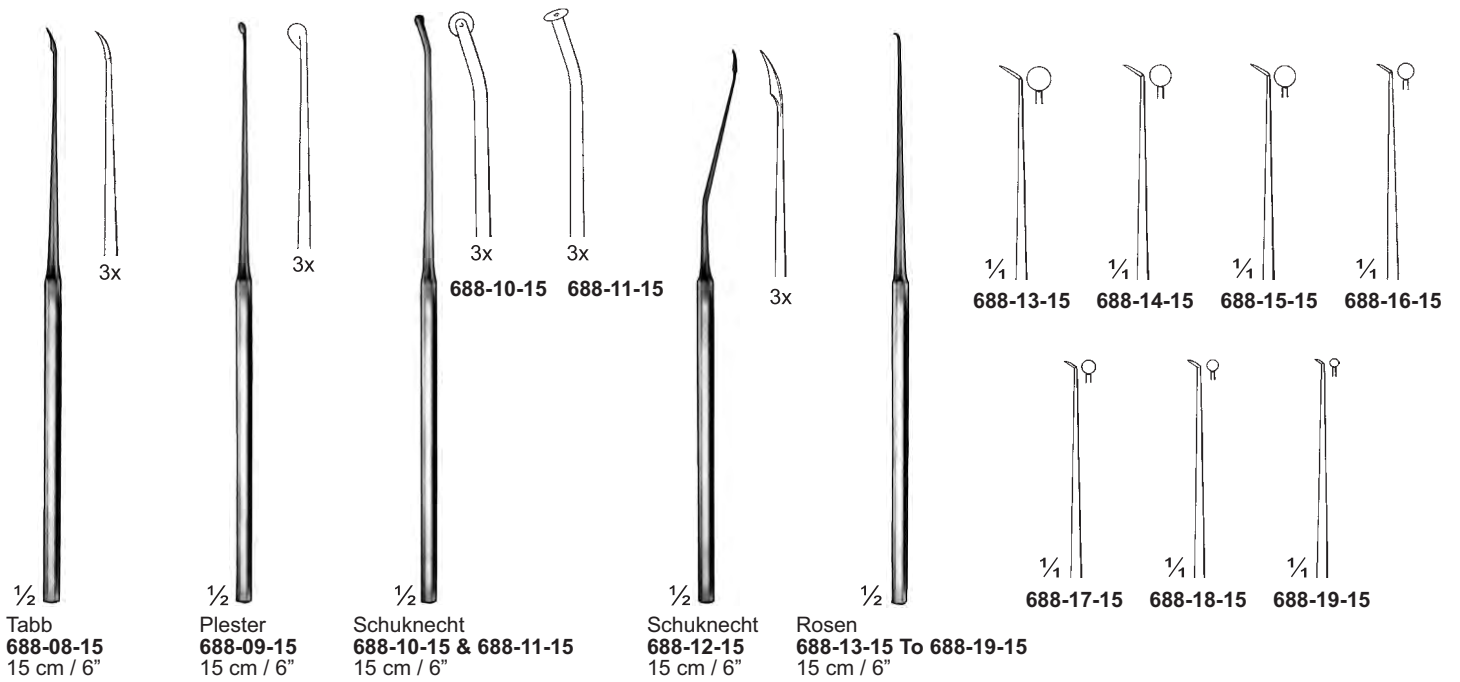
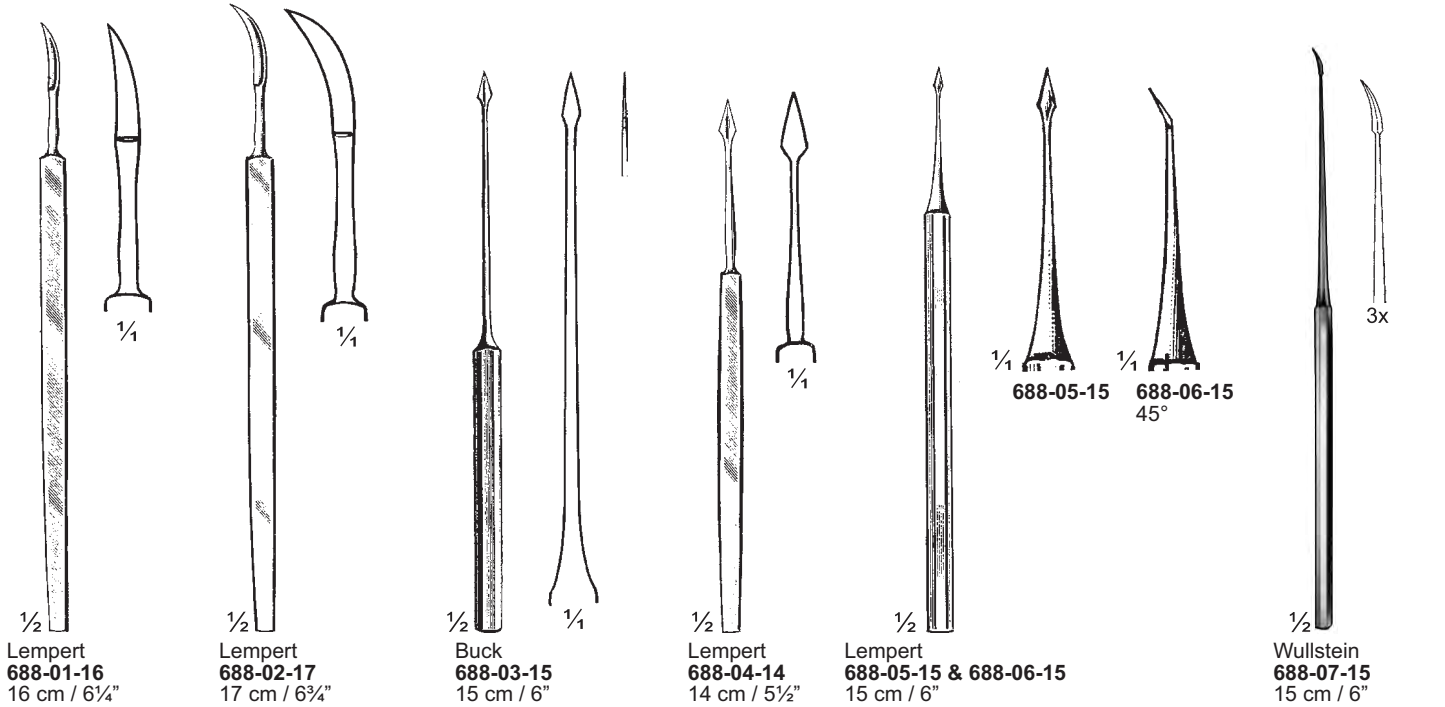

Mikro-Ohrmesser Micro Ear Knives Micro Couteaux auriculaires



1/2
Muck
689-01-13
13.5 cm / 5 1/2"



1/2
Poltzer
689-02-13
13.5 cm / 5 1/2"



1/2
Bruehl
689-03-15
15 cm / 6"



1/2
Bruehl
689-04-15
15 cm / 6"

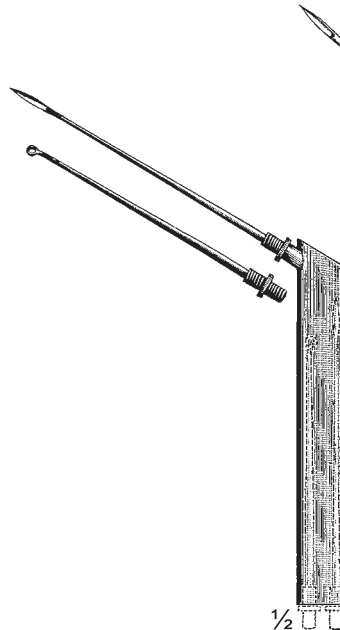

1/2
Reiner
689-05-19
19 cm / 7 1/2"

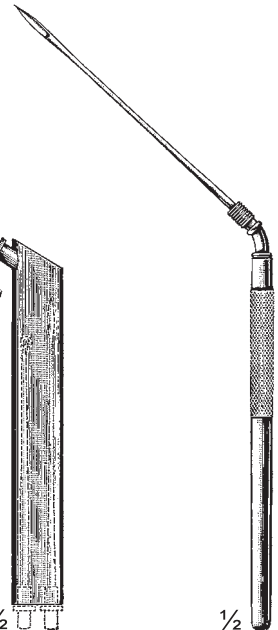

1/2
Gerzog
689-06-16
16 cm / 6 1/4"

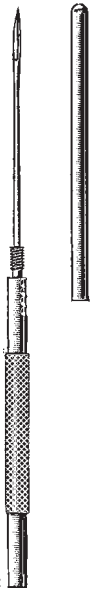

1/2
Friesner
689-07-16
16 cm / 6 1/4"

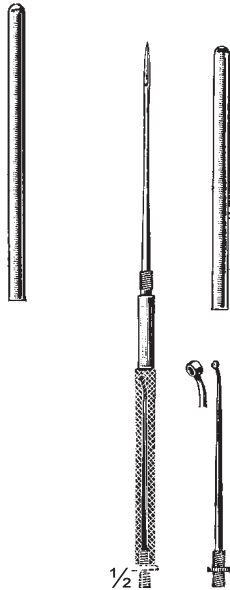

1/2
Dench
689-08-16
16 cm / 6 1/4"



1/2
Buck
689-09-16
16 cm / 6 1/4"



1/2
Poltzer
689-10-16
16 cm / 6 1/4"



1/2
689-11-19 To 689-15-19
19 cm / 7 1/2"



1/4
Royce
689-11-19



1/4
Royce
689-12-19



1/4
Sexton
689-13-19



1/4
Dintenfass
689-14-19



1/4
Poltzer
689-15-19

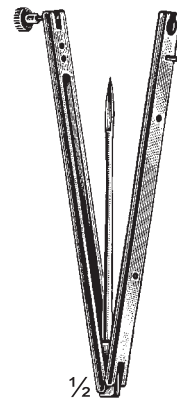

1/2

Trommelfellnadeln Tympanum Needles Aiguilles pour le tympan

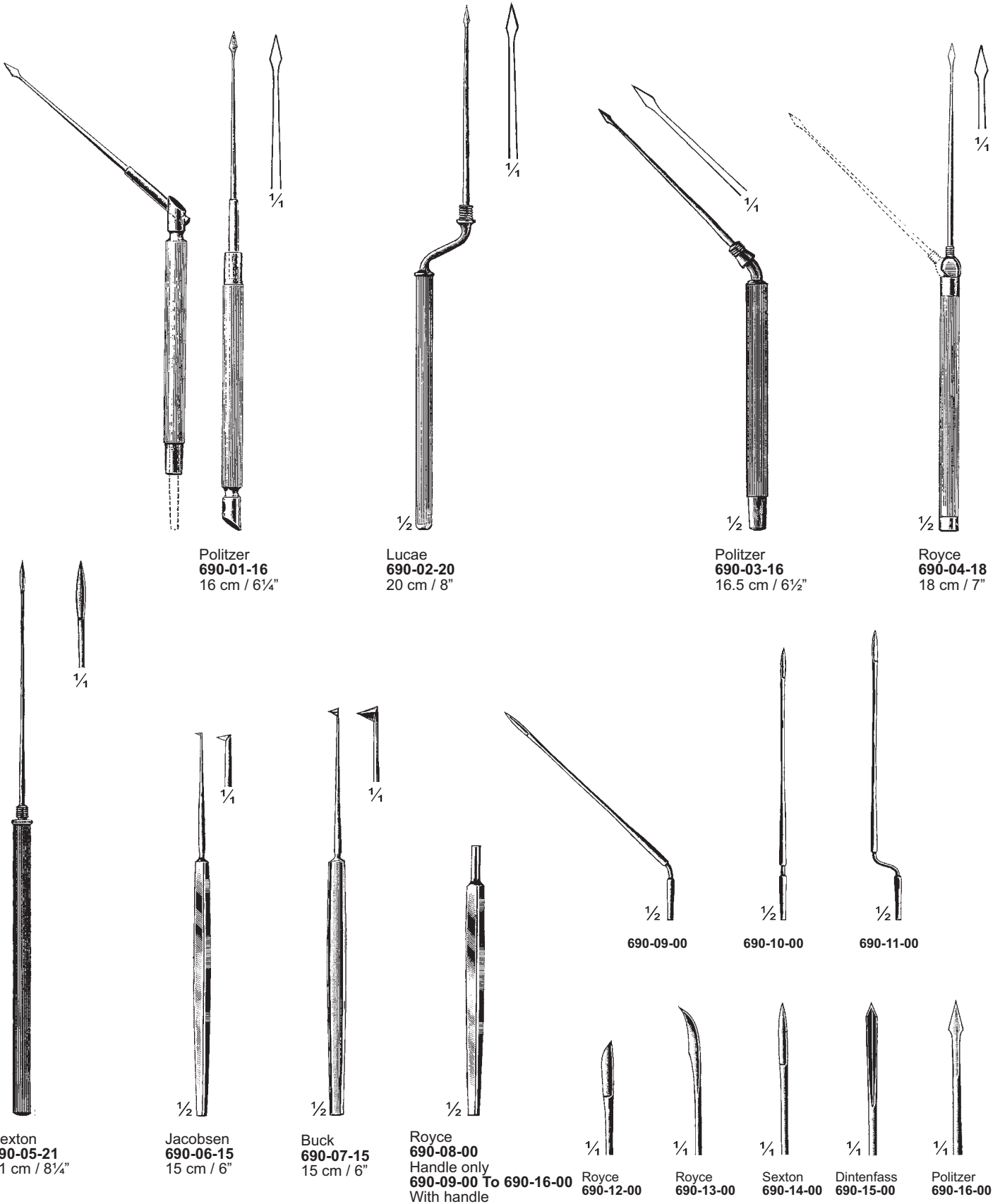

Politzer
690-01-16
16 cm / 6¼"

Lucae
690-02-20
20 cm / 8"

Politzer
690-03-16
16.5 cm / 6½"

Royce
690-04-18
18 cm / 7"

Sexton
690-05-21
21 cm / 8¼"

Jacobsen
690-06-15
15 cm / 6"

Buck
690-07-15
15 cm / 6"

Royce
690-08-00
Handle only
690-09-00 To 690-16-00
With handle

Royce
690-12-00

Royce
690-13-00

Sexton
690-14-00

Dintenfass
690-15-00

Politzer
690-16-00

Trommelfellnadeln Tympanum Needles Aiguilles pour le tympan



Lempert
691-01-16
16.5 cm / 6½"



Poltzer
691-02-16
16 cm / 6¼"

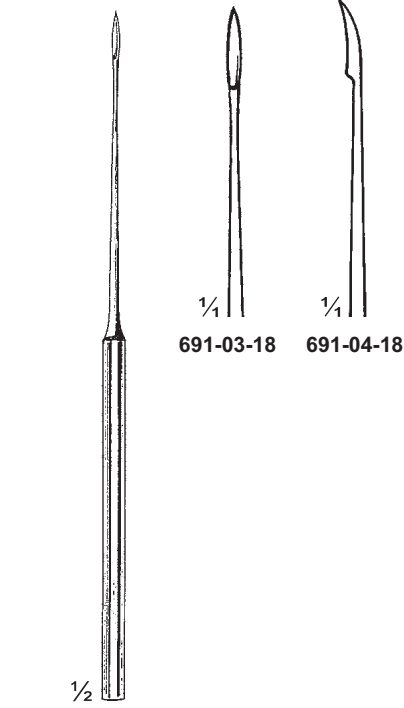

Sexton
691-03-18 & 691-04-18
18 cm / 7"

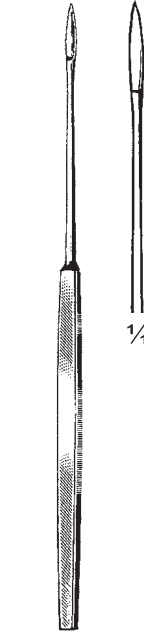

Sexton
691-05-18
18 cm / 7"



Gerzog-Sexton
691-06-17
17 cm / 6¾"



Locae (Royce)
691-07-18
18 cm / 7"



Locae (Royce)
691-08-18
18 cm / 7"

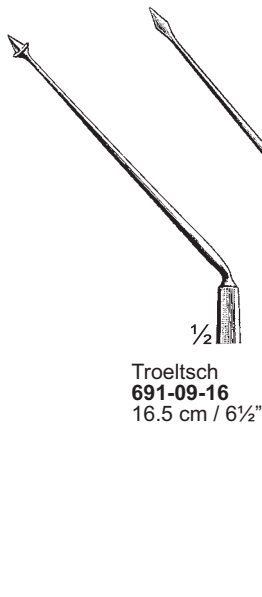

Troeltsch
691-09-16
16.5 cm / 6½"



Poltzer
691-10-16
16.5 cm / 6½"

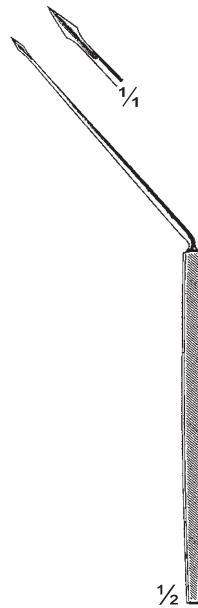

Poltzer
691-11-16
16.5 cm / 6½"

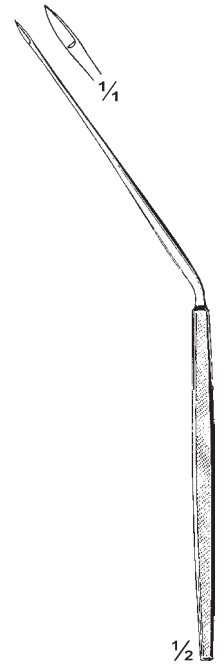

Sexton
691-12-17
17 cm / 6¾"

**Trommelfellnadeln
Tympanum Needles
Aiguilles pour le tympan**

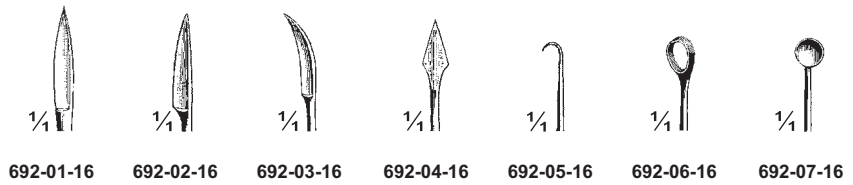
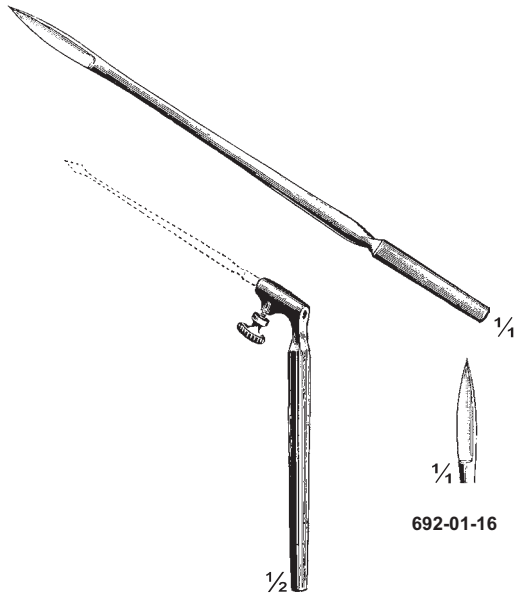

Hartmann
692-01-16 To 692-07-16
16.5 cm / 6 1/2"
692-08-00
Complete set consisting:
1 Handle and 7 tips

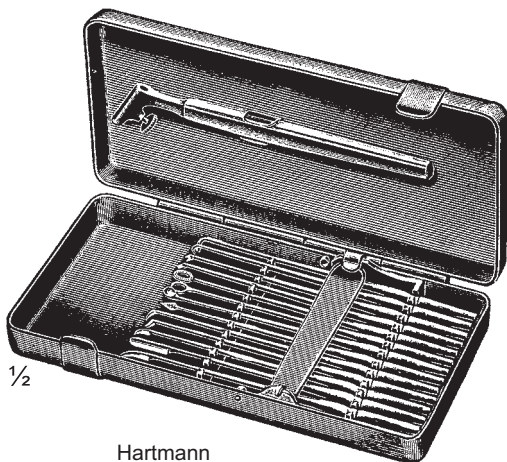

Hartmann
692-16-00
Complete set consisting:
1 Handle and 13 tips

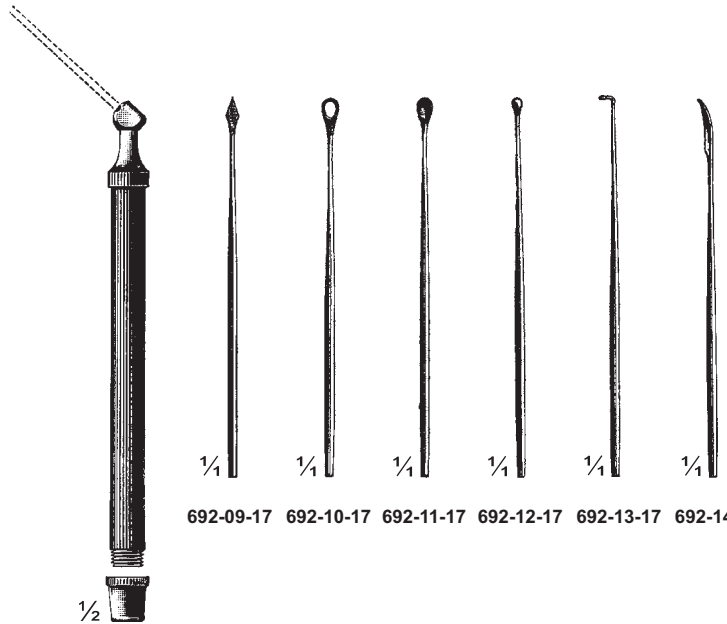

Sprague
692-09-17 To 692-14-17
17 cm / 6 3/4"
692-15-00
Complete set consisting:
1 Handle and 6 tips

Mikro-Ohräkchen, Mikro-Ohrnadeln Micro Ear Hooks, Micro Ear Needles Micro Crochets auriculaires, Micro Aiguilles auriculaires



693-01-15 To 693-24-15
15 cm / 6"

 $\frac{1}{4}$	693-01-15 0.3 mm 693-02-15 0.6 mm 693-03-15 1.0 mm 90°	 $\frac{1}{4}$	693-04-15 0.3 mm 693-05-15 0.6 mm 693-06-15 1.0 mm 90°	 $\frac{1}{4}$	McGee 693-07-15 0.5 mm 693-08-15 1.0 mm	 $\frac{1}{4}$	McGee 693-09-15 0.5 mm 693-10-15 1.0 mm	 $\frac{1}{4}$	Barbara 693-11-15
 $\frac{1}{4}$	Rosen 693-12-15	 $\frac{1}{4}$	693-13-15 0.3 mm 693-14-15 0.6 mm 693-15-15 1.0 mm 25°	 $\frac{1}{4}$	693-16-15 0.3 mm 693-17-15 0.6 mm 693-18-15 1.0 mm 25°	 $\frac{1}{4}$	693-19-15 0.3 mm 693-20-15 0.6 mm 693-21-15 1.0 mm 45°	 $\frac{1}{4}$	693-22-15 0.3 mm 693-23-15 0.6 mm 693-24-15 1.0 mm 45°



Barbara
693-25-15 To 693-47-15
15 cm / 6"

 $\frac{1}{4}$	693-25-15	 $\frac{1}{4}$	693-26-15	 $\frac{1}{4}$	693-27-15	 $\frac{1}{4}$	Rosen 693-28-15
 $\frac{1}{4}$	693-29-15 0.3 mm 693-30-15 0.6 mm 693-31-15 1.0 mm 25°	 $\frac{1}{4}$	693-32-15 0.3 mm 693-33-15 0.6 mm 693-34-15 1.0 mm 693-35-15 1.2 mm 693-36-15 1.5 mm 693-37-15 2.0 mm 693-38-15 2.5 mm 45°	 $\frac{1}{4}$	693-39-15 0.3 mm 693-40-15 0.6 mm 693-41-15 1.0 mm 693-42-15 1.2 mm 693-43-15 1.5 mm 693-44-15 2.0 mm 693-45-15 2.5 mm 90°	 $\frac{1}{4}$	693-46-15 0.3 mm 693-47-15 1.0 mm

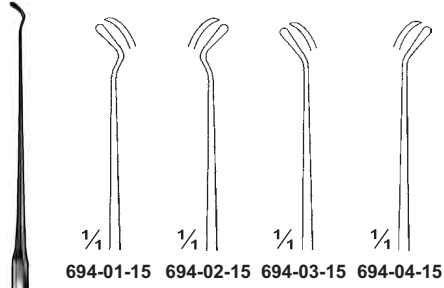

Fisch
694-01-15 To 694-04-15
15 cm / 6"

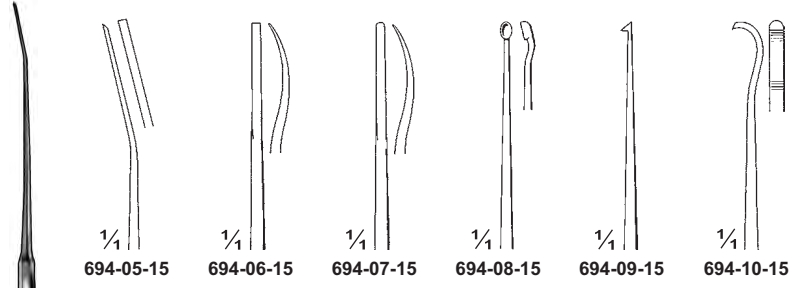

Rosen
694-05-15 To 694-10-15
15 cm / 6"

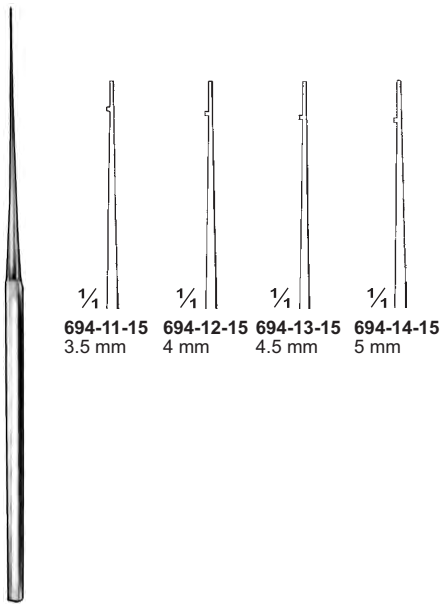

House
694-11-15 To 694-14-15
15 cm / 6"

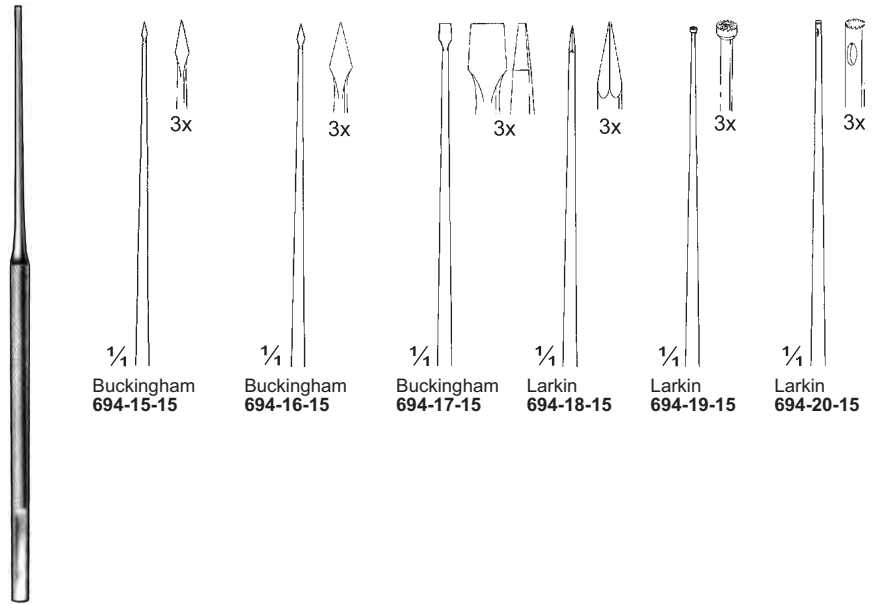

694-15-15 To 694-20-15
15 cm / 6"

**Bezahlen Sie Platten Hände Instrumente
Foot Plate Hand Instruments
Payer Les Instruments De Main De Plaque**



1.0 mm
 1.2 mm
 1.2 mm
695-01-14

1.5 mm
 1.8 mm
 1.8 mm
695-02-14



1.0 mm
 1.2 mm
 1.2 mm
695-03-14

1.5 mm
 1.8 mm
 1.8 mm
695-04-14



1.5 mm
695-05-11
 11 cm / 4 1/4"



695-06-18
18 cm / 7"

House
695-01-14 & 695-02-14
14 cm / 5 1/2"

House
695-03-14 & 695-04-14
14 cm / 5 1/2"

Shea
695-05-11
11 cm / 4 1/4"

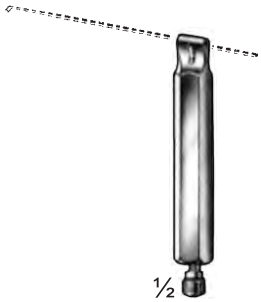

695-07-07
7 cm / 2 3/4"
Handle for
items 695-08-07 To 695-14-07



1/4"
695-08-07
7 cm / 2 3/4"

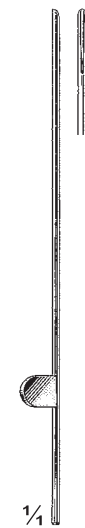

1/4"
695-09-07
7 cm / 2 3/4"



1/4"
695-10-07
7 cm / 2 3/4"



1/4"
695-11-07
7 cm / 2 3/4"



1/4"
695-12-07
7 cm / 2 3/4"



1/4"
695-13-07
7 cm / 2 3/4"



1/4"
695-14-07
7 cm / 2 3/4"

Ohrküretten, Ohrlöffel Ear Curettes, Ear Scoop Curettes auriculaires, Curette auriculaire

	 Blunt	 1/4 696-01-16 No. 000	 1/4 696-02-16 No. 00	 1/4 696-03-16 No. 0	 1/4 696-04-16 No. 1	 1/4 696-05-16 No. 2	 1/4 696-06-16 No. 3	 1/4 696-07-16 No. 4
	 Sharp	 1/4 696-08-16 No. 000	 1/4 696-09-16 No. 00	 1/4 696-10-16 No. 0	 1/4 696-11-16 No. 1	 1/4 696-12-16 No. 2	 1/4 696-13-16 No. 3	 1/4 696-14-16 No. 4
	 Blunt	 1/4 696-15-16 No. 000	 1/4 696-16-16 No. 00	 1/4 696-17-16 No. 0	 1/4 696-18-16 No. 1	 1/4 696-19-16 No. 2	 1/4 696-20-16 No. 3	 1/4 696-21-16 No. 4
	 Sharp	 1/4 696-22-16 No. 000	 1/4 696-23-16 No. 00	 1/4 696-24-16 No. 0	 1/4 696-25-16 No. 1	 1/4 696-26-16 No. 2	 1/4 696-27-16 No. 3	 1/4 696-28-16 No. 4



Buck
696-01-16 To 696-28-16
16.5 cm / 6 1/2"

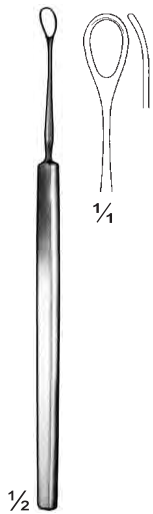

Langenbeck
696-29-13
13 cm / 5 1/8"



Coxeter
696-30-14
14.5 cm / 5 3/4"



Shapleigh
696-31-13 To 696-34-13
13 cm / 5 1/8"

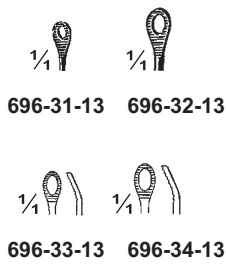

696-35-17 Blunt
696-36-17 Sharp
17 cm / 6 3/4"



696-37-15
15 cm / 6"
Sharp



696-38-18
18 cm / 7"
Sharp

Ohrküretten, Ohrlöffel
 Ear Cures, Ear Scoop
 Cures auriculaires, Curette auriculaire

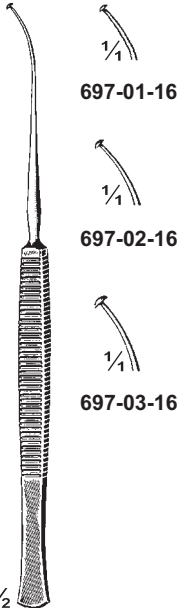

Yankauer
 697-01-16 To 697-03-16
 16 cm / 6 1/4"



Wolf
 697-04-16
 16 cm / 6 1/4"
 Sharp



Bishop
 697-05-16 To 697-08-16
 16 cm / 6 1/4"
 Sharp



House
 697-09-15
 15 cm / 6"



Antoli-Candela
 697-10-15
 15 cm / 6"



Roser
 697-11-14
 14 cm / 5 1/2"
 Blunt



Gross
 697-12-12
 12 cm / 4 3/4"
 Sharp/Blunt



Gross
 697-13-12
 12 cm / 4 3/4"
 Blunt



Gross
 697-14-12
 12 cm / 4 3/4"
 Blunt

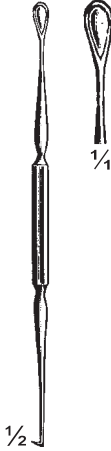

Gross
 697-15-12
 12 cm / 4 3/4"
 Sharp/Blunt



Gross
 697-16-12
 12 cm / 4 3/4"
 Blunt

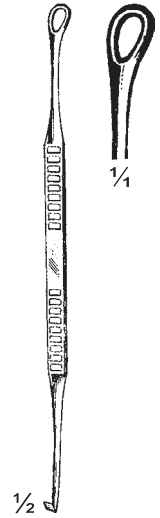

Gardner-Brown
 697-17-14
 14 cm / 5 1/2"

Ohrküretten, Ohrlöffel Ear Cures, Ear Scoop Curettes auriculaires, Curette auriculaire

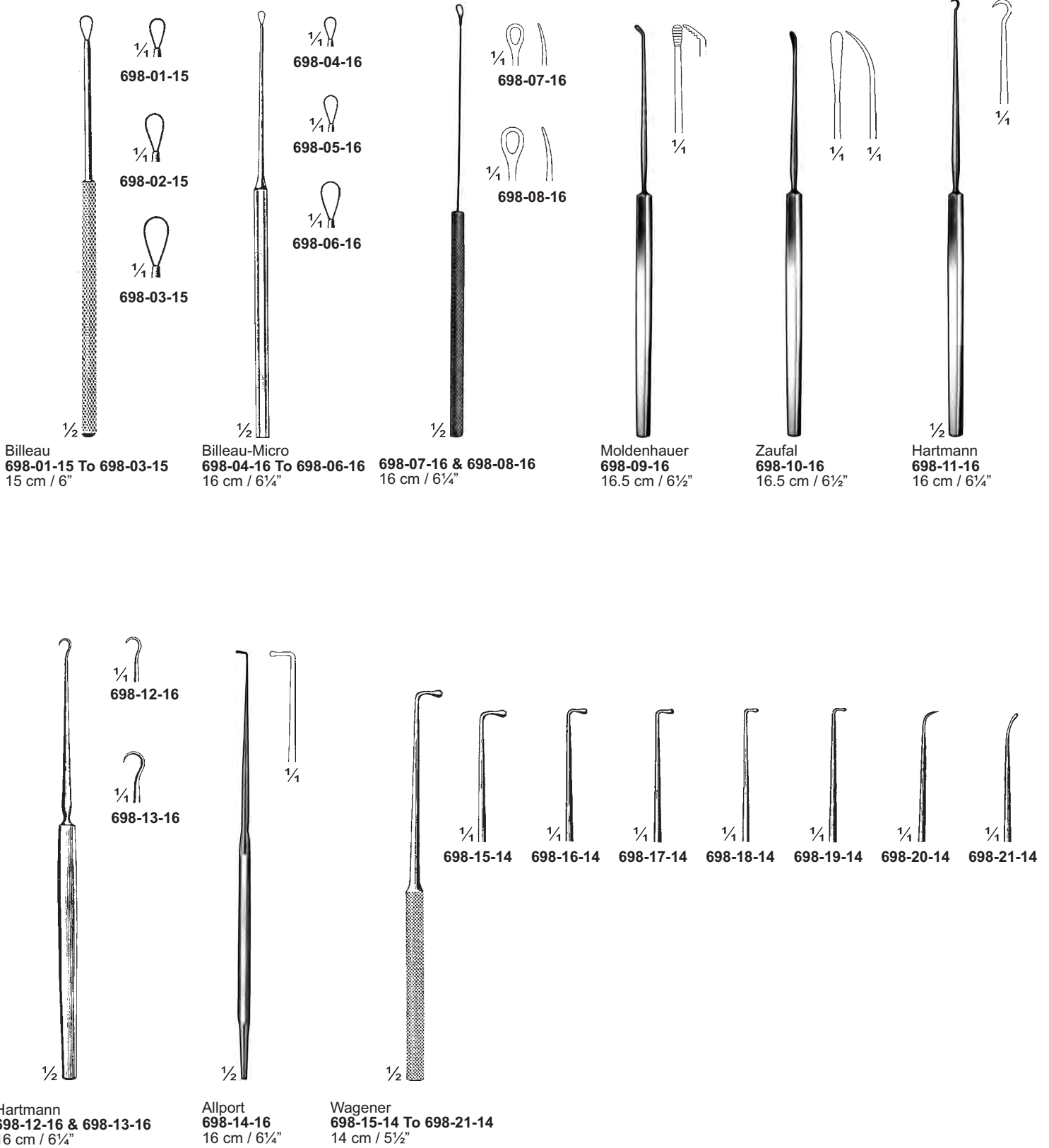

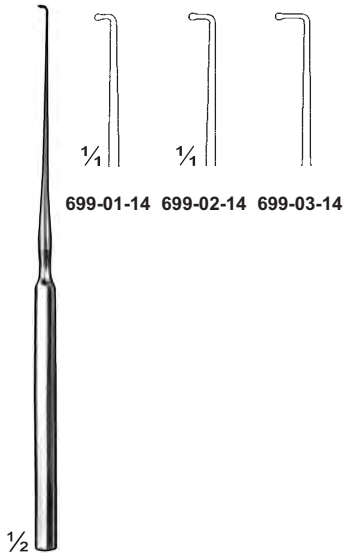

699-01-14 699-02-14 699-03-14

Lucae
699-01-14 To 699-03-14
14 cm / 5 1/2"



699-04-15
699-05-15

Jansen
699-04-15 & 699-05-15
15 cm / 6"



Yankauer-Jansen
699-06-15
15 cm / 6"



Yankauer
699-07-16
16.5 cm / 6 1/2"



699-08-16
699-09-16

Day
699-08-16 & 699-09-16
16 cm / 6 1/4"

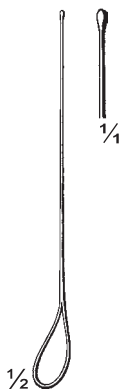

Stacke
699-10-11
11 cm / 4 1/4"



Holz
699-11-13
13.5 cm / 5 1/4"



Jansen-Newhart
699-12-17
17 cm / 6 3/4"



Lucae
699-13-19
19 cm / 7 1/2"

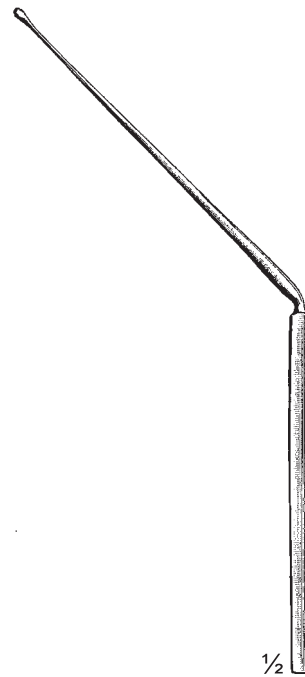

Troeltsch
699-14-20
20 cm / 8"

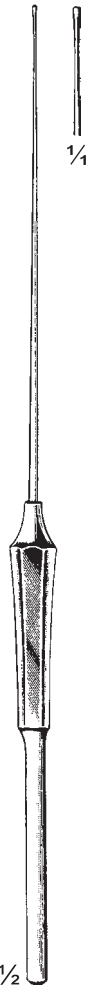

Wullstein
699-15-26
26 cm / 10 1/4"

Ohrraspatorien Elevators Rugines-raspatoires auriculaires

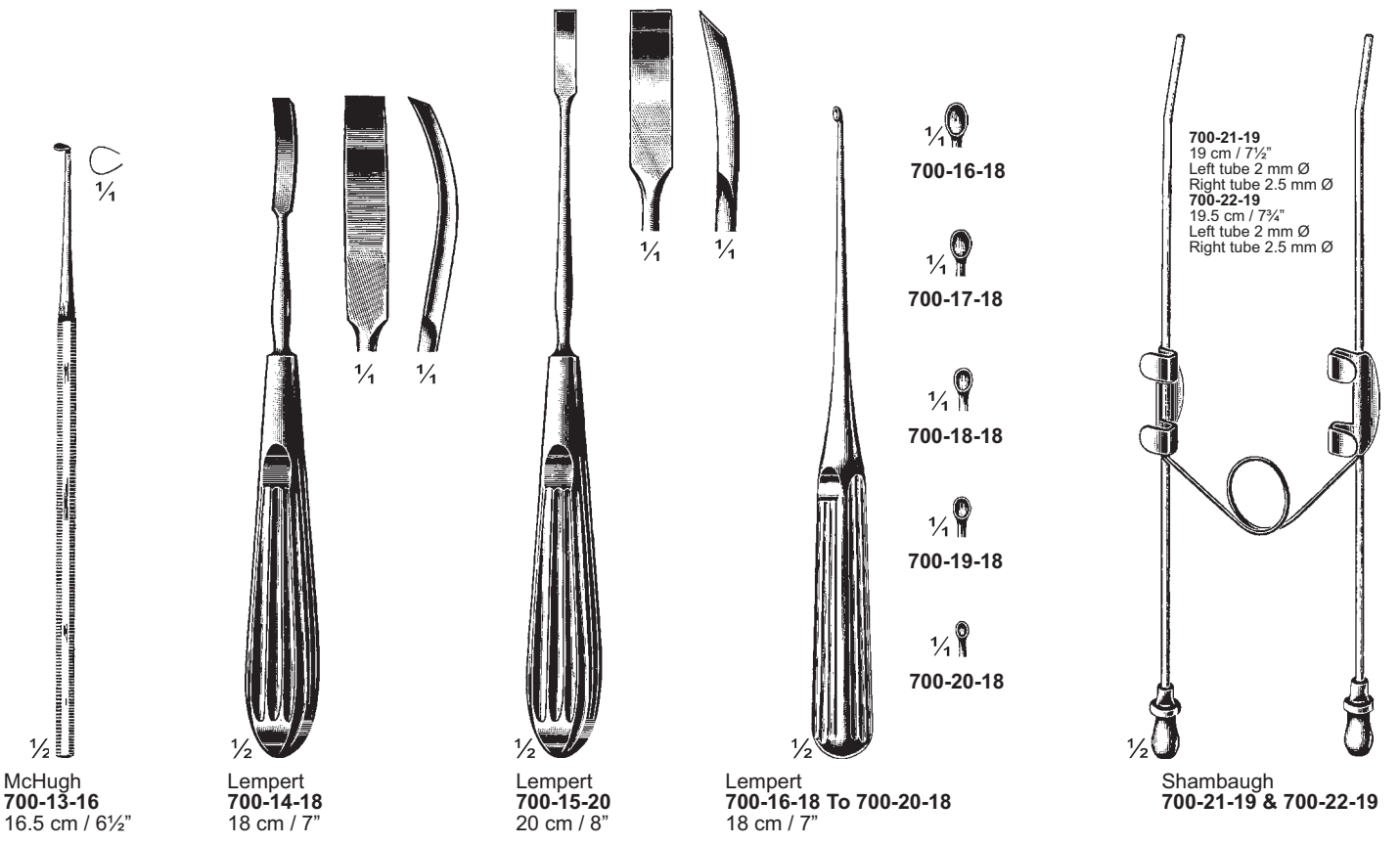
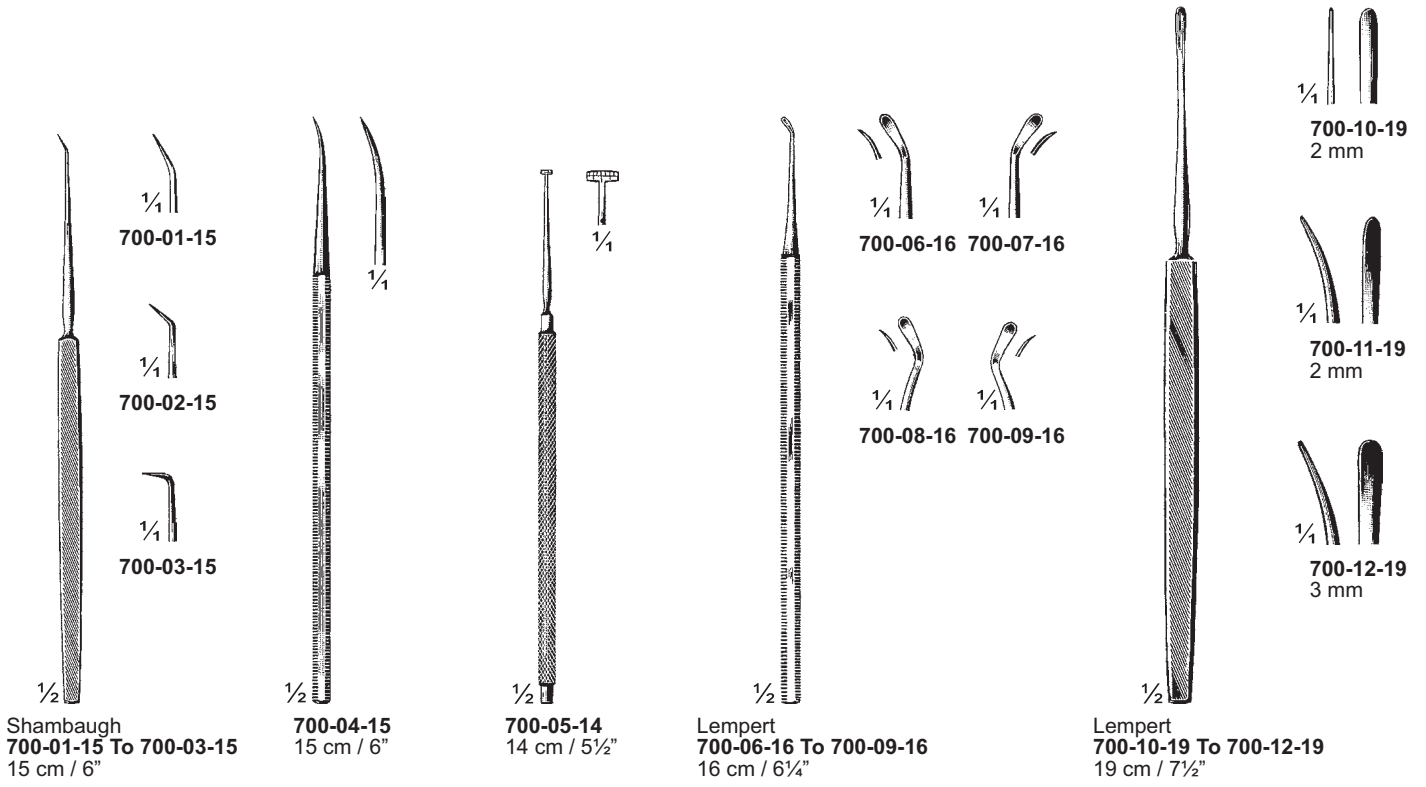

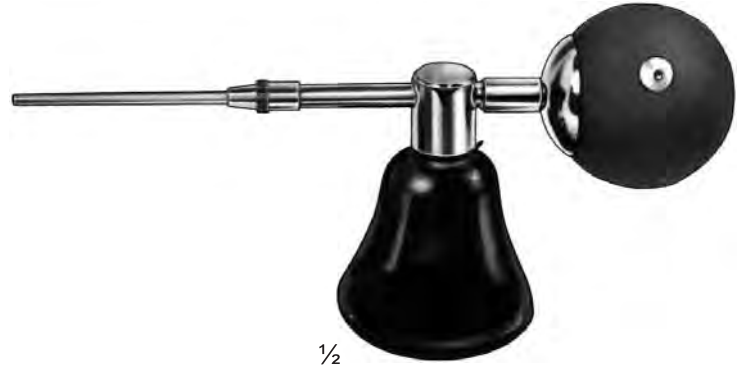

**Kabierske
701-01-30**
30 ccm
complete with 3 cannulas
for nose throat and larynx



701-02-50 50 ml
701-03-75 75 ml
701-04-100 100 ml
complete with 2 cannulas
and protecting disk



701-05-20 20 ml
701-06-30 30 ml
complete with 1 cannula

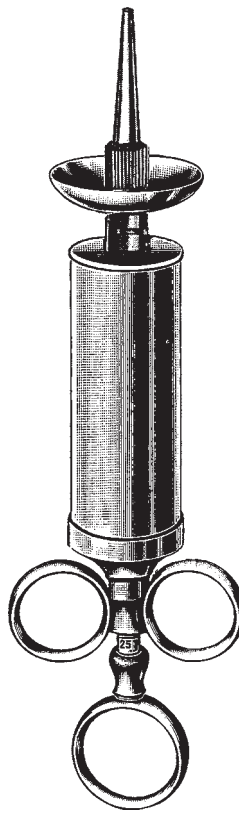

Luer-Lock
701-07-50 50 ml
701-08-75 75 ml
701-09-100 100 ml
complete with 2 cannulas
and 1 protecting disk



701-10-50 50 ml
701-11-75 75 ml
701-12-100 100 ml
complete with 3 cannulas
and 1 protecting disk

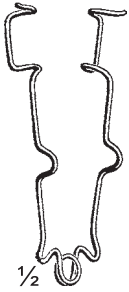

Bowman
702-01-07
7 cm / 2¾"

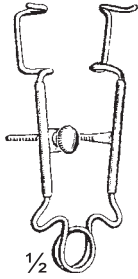

Critchett
702-02-07
7 cm / 2¾"

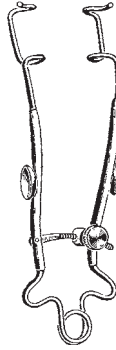

Graefe
702-03-07 Infants
7 cm / 2¾"
702-04-09 Adults
9 cm / 3½"

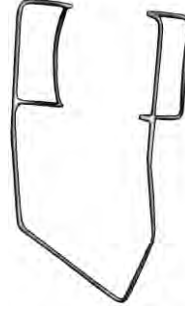

Barraquer (Colibri)
702-05-07 Infants
7 cm / 2¾"
702-06-09 Adults
9 cm / 3½"

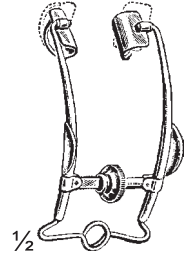

Pley
702-07-06
6 cm / 2½"

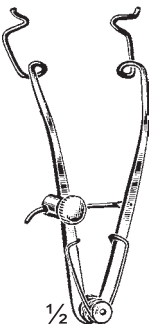

Weiss
702-08-08
8 cm / 3¼"

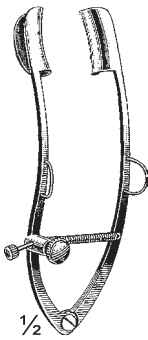

Weiss
702-09-07 Infants
7 cm / 2¾"
702-10-09 Adults
9 cm / 3½"

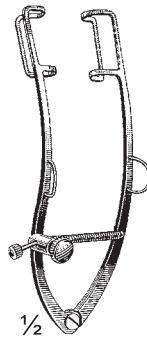

Weiss
702-11-07 Infants
7 cm / 2¾"
702-12-09 Adults
9 cm / 3½"

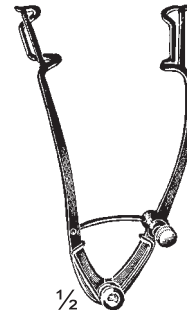

Weiss
702-13-07 Infants
7 cm / 2¾"
702-14-08 Adults
8 cm / 3¼"

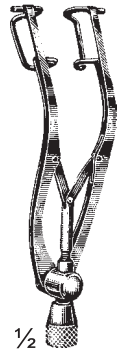

Weiss
702-15-08
8 cm / 3¼"

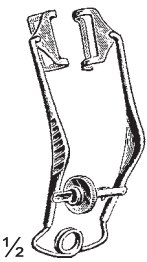

Ziegler
702-16-07
7 cm / 2¾"

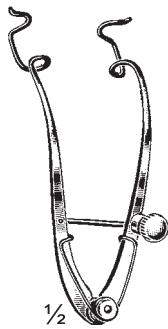

Knapp-Clark
702-17-08
8 cm / 3¼"

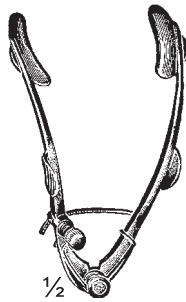

Lister-Burch
702-18-08
8 cm / 3¼"



Lancaster
702-19-07
7 cm / 2¾"

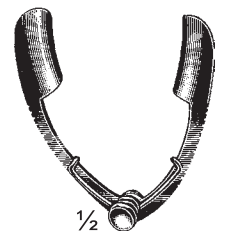

Sauer
702-20-03
3 cm / 1¼"

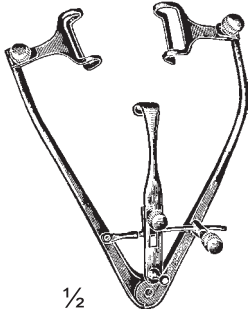

1/2

Guyton-Park
703-01-08
8 cm / 3 1/4"

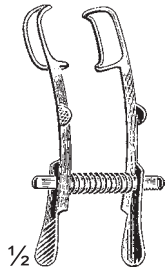

1/2

Mellinger
703-02-05 Infants
5 cm / 2"
703-03-07 Adults
7 cm / 2 3/4"

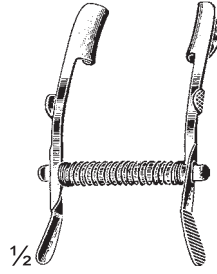

1/2

Mellinger-Beard
703-04-05 Infants
5 cm / 2"
703-05-07 Adults
7 cm / 2 3/4"

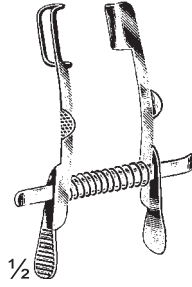

1/2

Mellinger-Axenfeld
703-06-07
7 cm / 2 3/4"

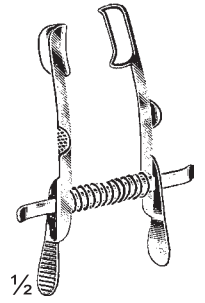

1/2

Mellinger-Axenfeld
703-07-07
7 cm / 2 3/4"

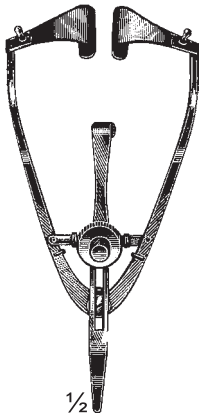

1/2

Park-Maumenee
703-08-08
8 cm / 3 1/4"

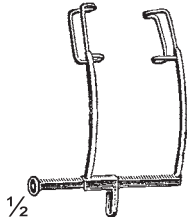

1/2

Murdock
703-09-05
5 cm / 2"

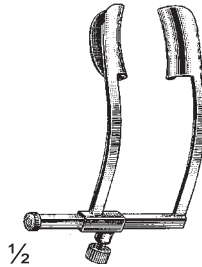

1/2

Cook
703-10-04 Infants
4 cm / 1 1/2"
703-11-05 Adults
5 cm / 2"

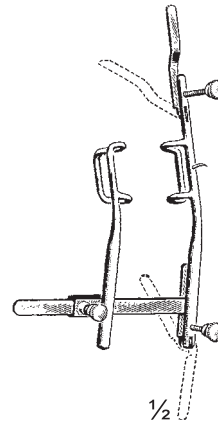

1/2

Arruga
703-12-07
7 cm / 2 3/4"

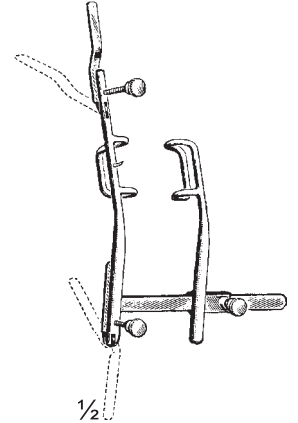

1/2

Arruga
703-13-07
7 cm / 2 3/4"

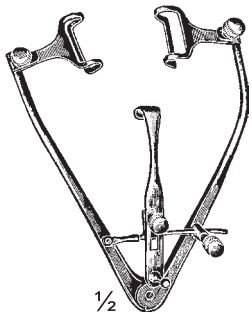

1/2

Park
703-14-08
8 cm / 3 1/4"



1/2

Muller
703-15-07
7 cm / 2 3/4"



1/2

Stevenson
703-16-07
7 cm / 2 3/4"

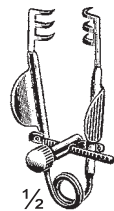

1/2

Agricola
703-17-04
4 cm / 1 1/2"

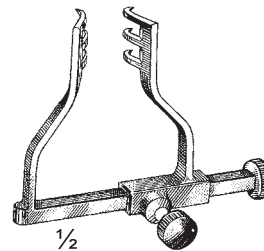

1/2

Goldstein
703-18-03
3 cm / 1 1/4"

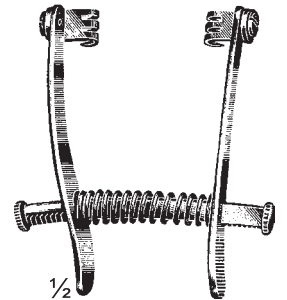

1/2

Axenfeld
703-19-08
8 cm / 3 1/4"



Pess
704-01-13
13 cm / 5 1/8"



Berens
704-02-09
9 cm / 3 1/2"



Siniscal-Smith
704-03-11
11 cm / 4 1/2"



704-04-09
9 cm / 3 1/2"



Muldoon
704-05-08
8 cm / 3 1/4"

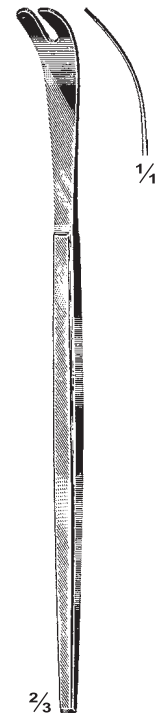

Schepens
704-06-13
13 cm / 5 1/8"



Conway
704-07-13
13 cm / 5 1/8"

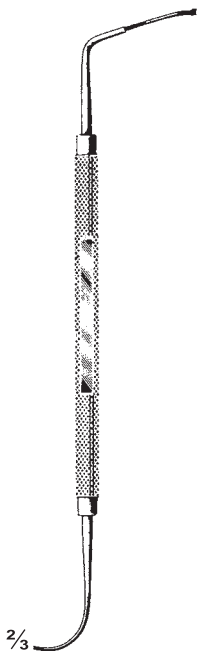

Amenabar
704-08-13
13 cm / 5 1/8"

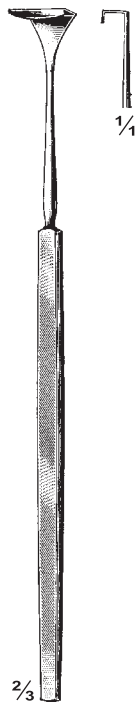

Groenholm
704-09-13
13 cm / 5 1/8"



Desmarres
704-10-13
13 cm / 5 1/8"



Desmarres
704-11-12 To 704-18-18
13 cm / 5 1/8"



704-11-12
12 mm

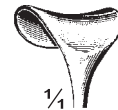

704-12-14
14 mm

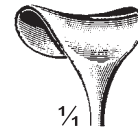

704-13-16
16 mm

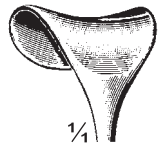

704-14-18
18 mm



704-15-12
12 mm



704-16-14
14 mm



704-17-17
16 mm



704-18-18
18 mm

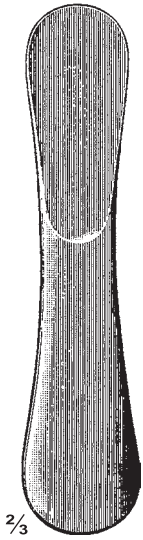

$\frac{2}{3}$
Jaeger
705-01-11
11 cm / 4 $\frac{1}{2}$ "
Lid plate



$\frac{1}{4}$
Castroviejo
705-02-00
Lid plate clamp



$\frac{2}{3}$
Berens
705-03-13
13 cm / 5 $\frac{1}{8}$ "
Suture spatula



$\frac{1}{2}$
Fink
705-04-08
8 cm / 3 $\frac{1}{4}$ "
Bi-Prong-Marker

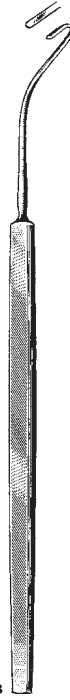

$\frac{2}{3}$
Scobee
705-05-13
13 cm / 5 $\frac{1}{8}$ "
Muscle hook



$\frac{2}{3}$
705-06-13
13 cm / 5 $\frac{1}{8}$ "



$\frac{2}{3}$
705-07-13 To 705-13-13
13.5 cm / 5 $\frac{1}{4}$ "

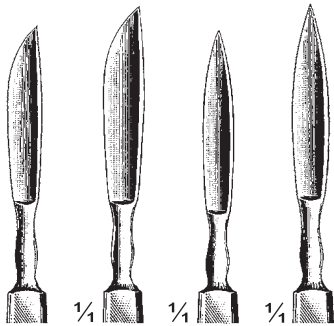

$\frac{1}{4}$ 705-07-13 $\frac{1}{4}$ 705-08-13 $\frac{1}{4}$ 705-09-13 $\frac{1}{4}$ 705-10-13

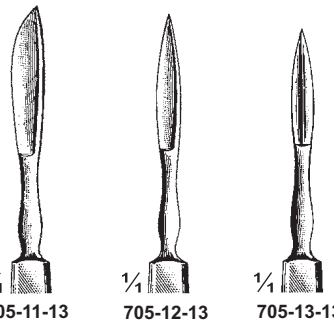

$\frac{1}{4}$ 705-11-13 $\frac{1}{4}$ 705-12-13 $\frac{1}{4}$ 705-13-13



$\frac{2}{3}$
705-14-13 To 705-25-13
13.5 cm / 5 $\frac{1}{4}$ "

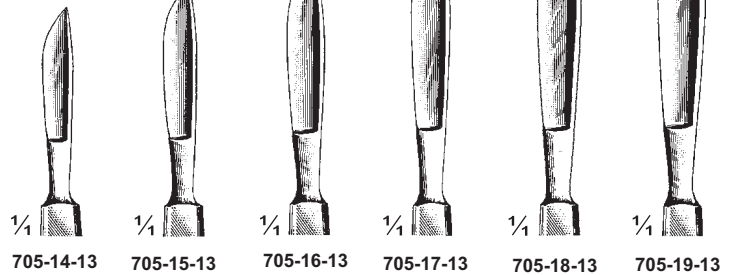

$\frac{1}{4}$ 705-14-13 $\frac{1}{4}$ 705-15-13 $\frac{1}{4}$ 705-16-13 $\frac{1}{4}$ 705-17-13 $\frac{1}{4}$ 705-18-13 $\frac{1}{4}$ 705-19-13

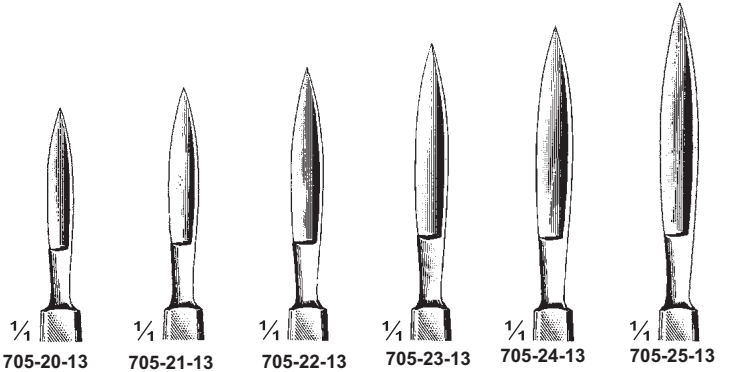

$\frac{1}{4}$ 705-20-13 $\frac{1}{4}$ 705-21-13 $\frac{1}{4}$ 705-22-13 $\frac{1}{4}$ 705-23-13 $\frac{1}{4}$ 705-24-13 $\frac{1}{4}$ 705-25-13



706-01-13 To 706-14-13
13.5 cm / 5 1/4"

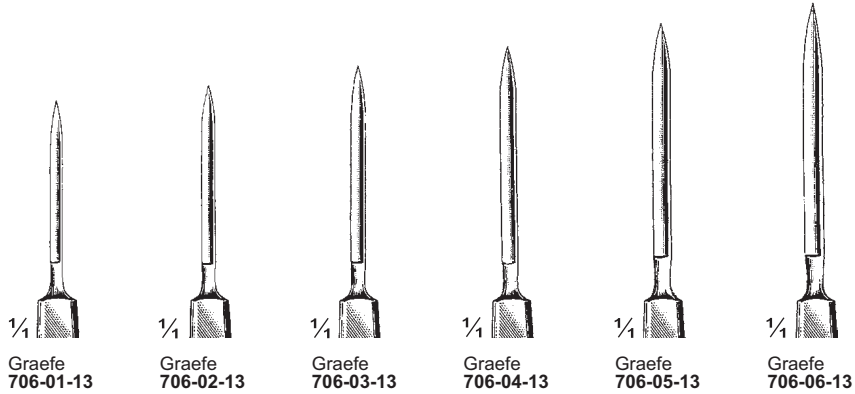

1/4 Graefe 706-01-13 1/4 Graefe 706-02-13 1/4 Graefe 706-03-13 1/4 Graefe 706-04-13 1/4 Graefe 706-05-13 1/4 Graefe 706-06-13

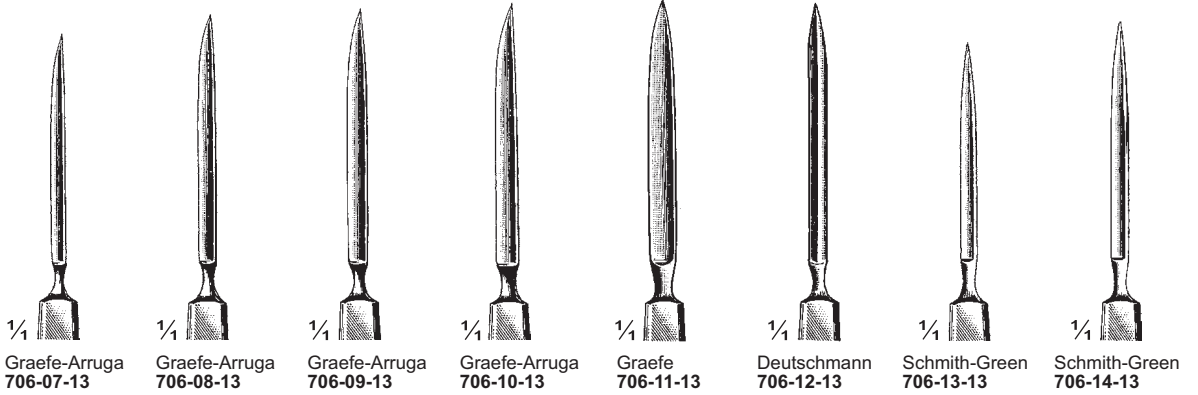

1/4 Graefe-Arruga 706-07-13 1/4 Graefe-Arruga 706-08-13 1/4 Graefe-Arruga 706-09-13 1/4 Graefe-Arruga 706-10-13 1/4 Graefe 706-11-13 1/4 Deutschmann 706-12-13 1/4 Schmith-Green 706-13-13 1/4 Schmith-Green 706-14-13



Castroviejo
706-15-09 To 706-17-09
9 cm / 3 1/2"



1/4 706-15-09



1/4 706-16-09

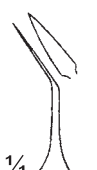

1/4 706-17-09



Barraquer
706-18-13
13.5 cm / 5 1/4"

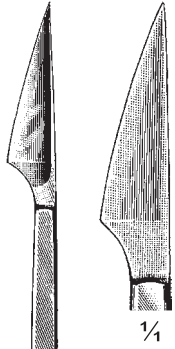

Beer
706-19-13
13.5 cm / 5 1/4"



706-20-13 To 706-22-18
13.5 cm / 5 1/4"

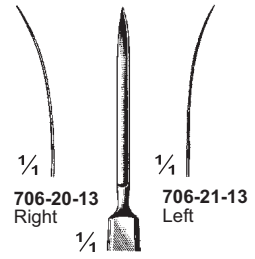

1/4 706-20-13 Right 1/4 706-21-13 Left
Berens
706-20-13 & 706-21-13
Glaucoma knives



1/4 Wheeler
706-22-18
18 X 1 mm
Discission knife

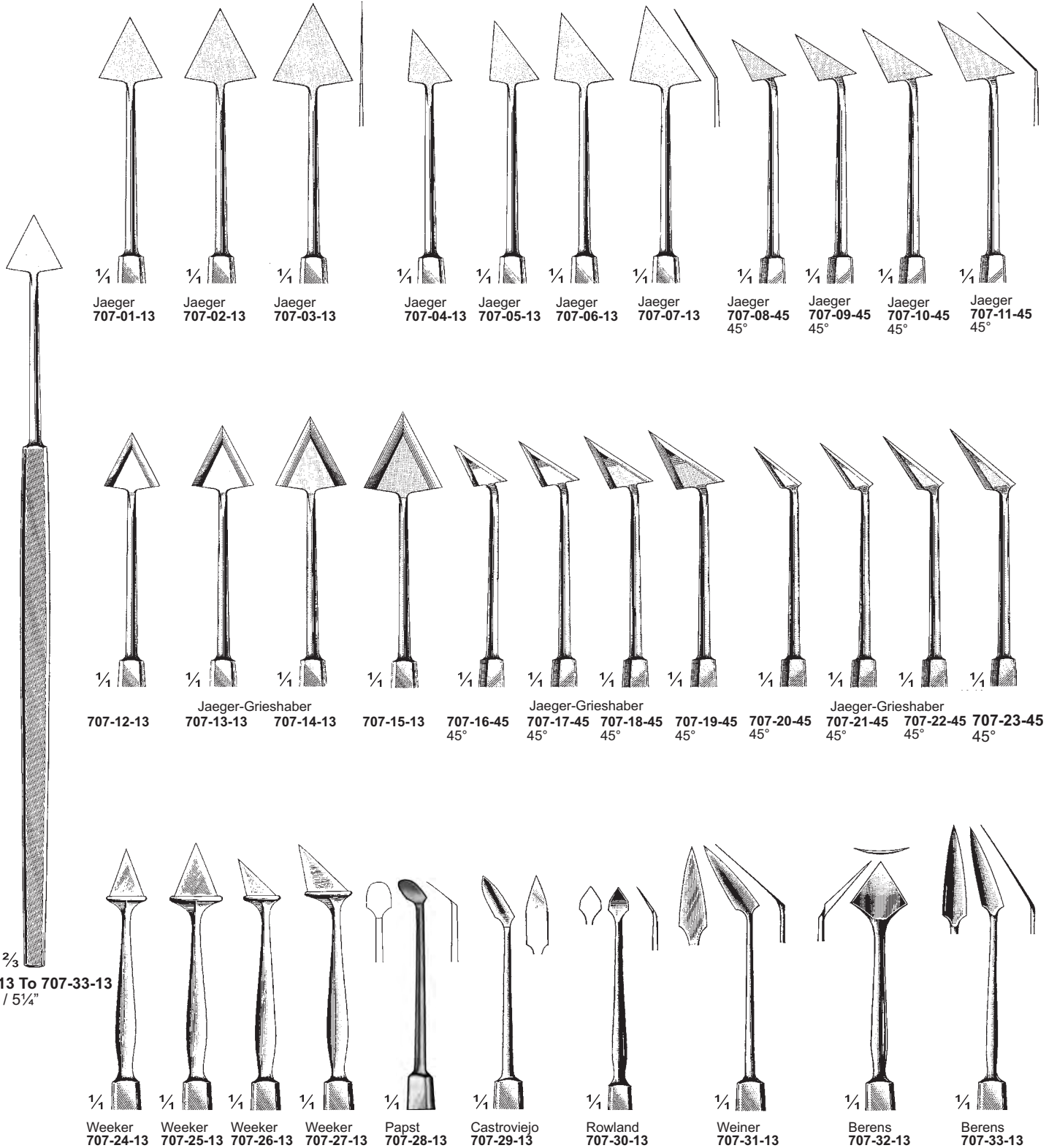

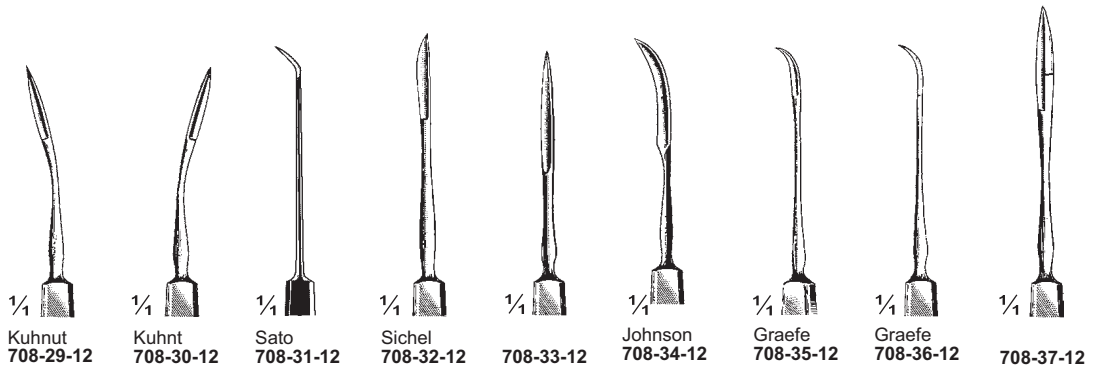
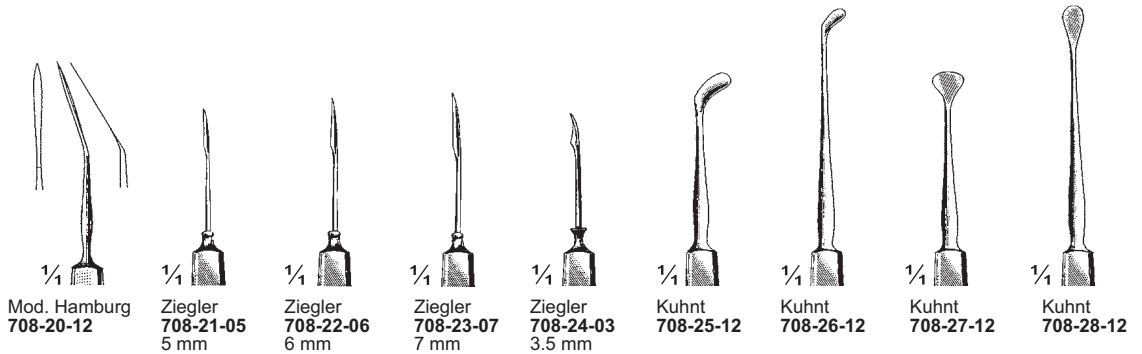
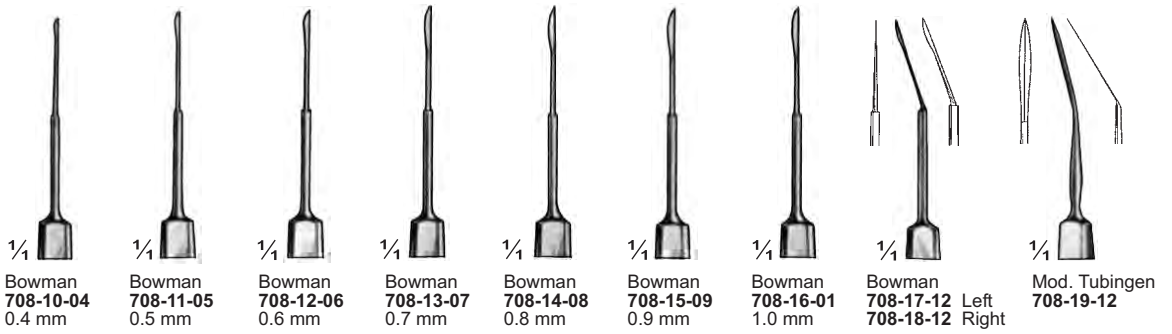
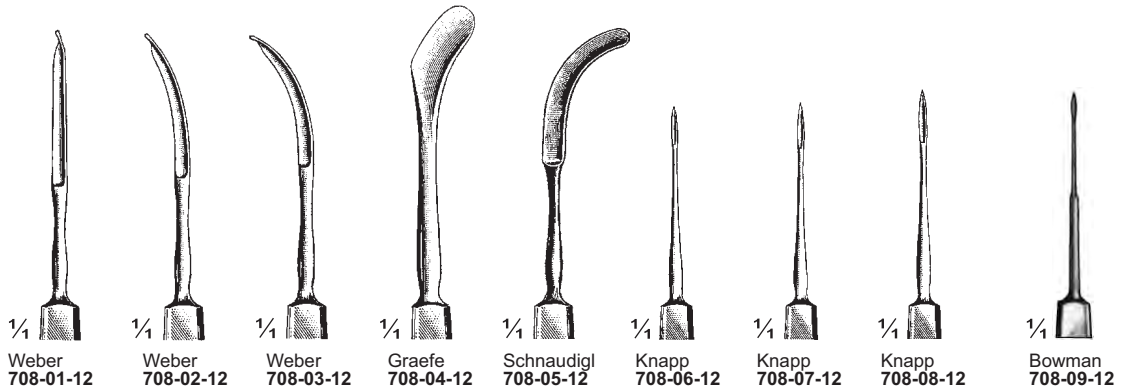

708-01-12 To 708-37-12
12 cm / 4 $\frac{3}{4}$ "

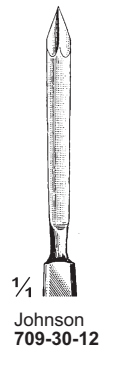
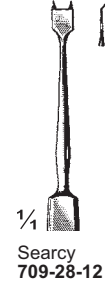
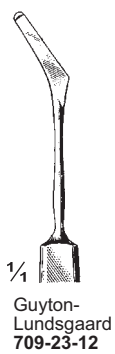
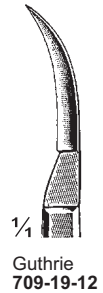
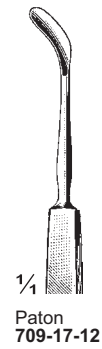
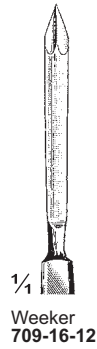
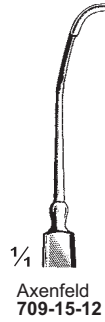
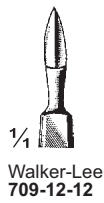
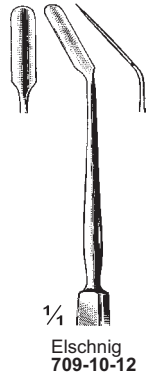
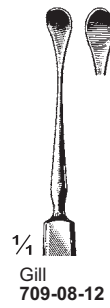
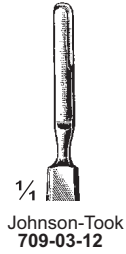

709-01-12 To 709-40-12
12.5 cm / 5"

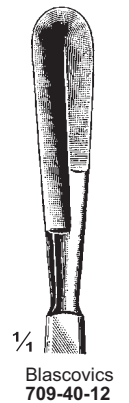
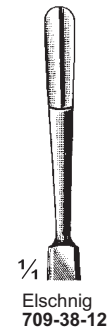

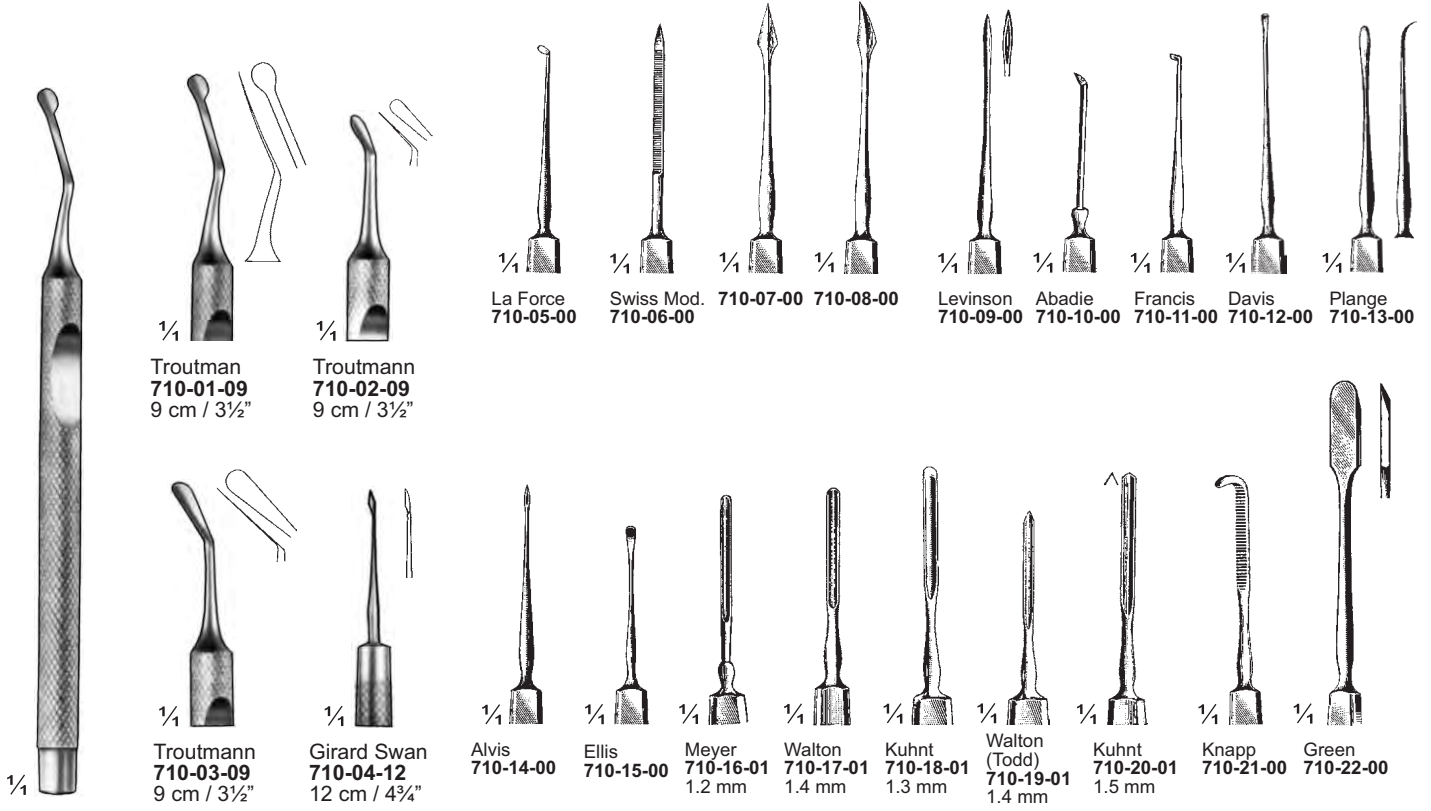

1/4
Troutman
710-01-09
9 cm / 3 1/2"

1/4
Troutman
710-02-09
9 cm / 3 1/2"

1/4
La Force
710-05-00

1/4
Swiss Mod.
710-06-00

1/4
710-07-00

1/4
710-08-00

1/4
Levison
710-09-00

1/4
Abadie
710-10-00

1/4
Francis
710-11-00

1/4
Davis
710-12-00

1/4
Plange
710-13-00

1/4
Troutman
710-03-09
9 cm / 3 1/2"

1/4
Girard Swan
710-04-12
12 cm / 4 3/4"

1/4
Alvis
710-14-00

1/4
Ellis
710-15-00

1/4
Meyer
710-16-01
1.2 mm

1/4
Walton
710-17-01
1.4 mm

1/4
Kuhnt
710-18-01
1.3 mm

1/4
Walton
(Todd)
710-19-01
1.4 mm

1/4
Kuhnt
710-20-01
1.5 mm

1/4
Knapp
710-21-00

1/4
Green
710-22-00

710-01-09 To 710-04-12

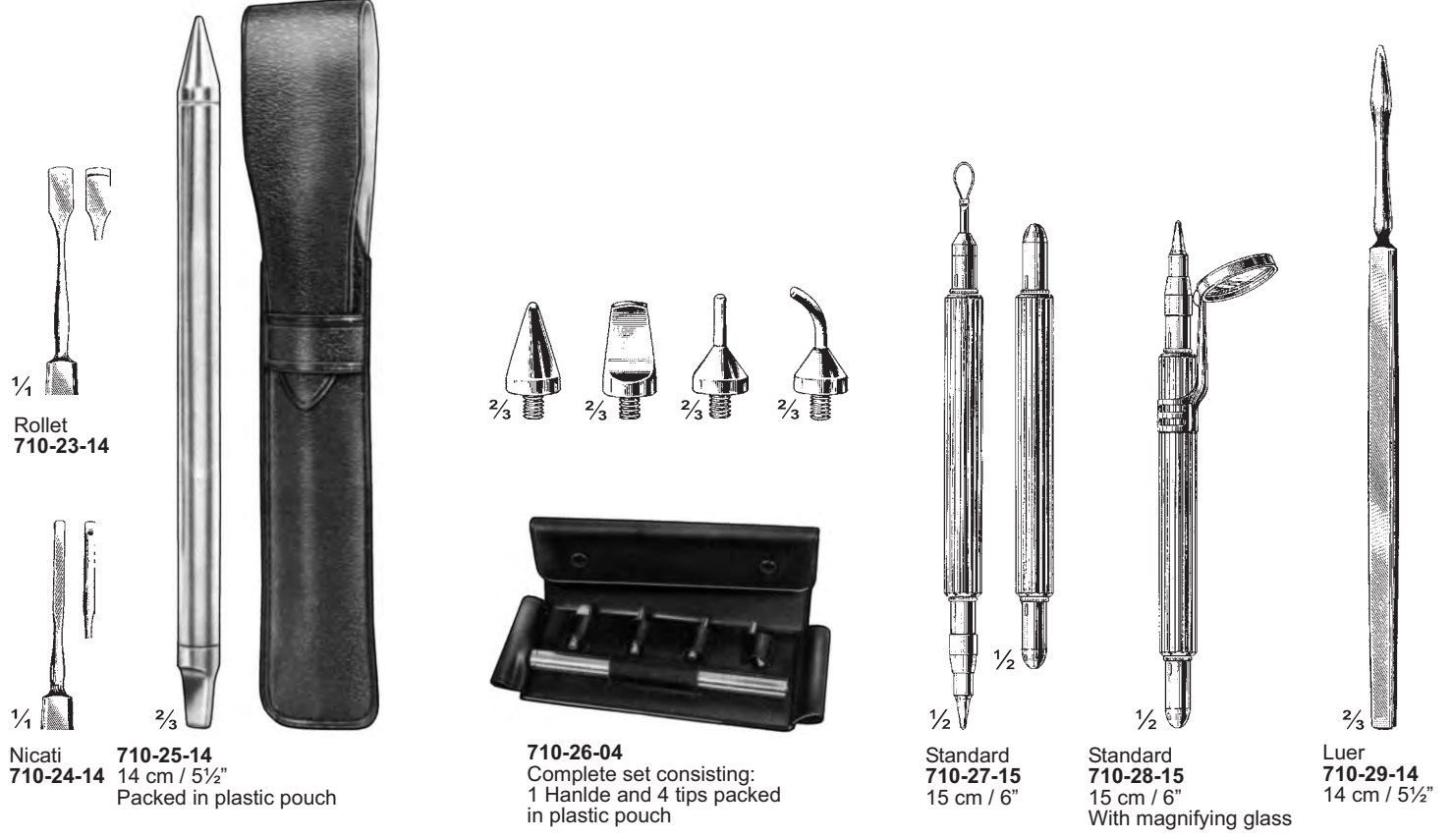

1/4
Rollet
710-23-14

1/4
Nicati
710-24-14

710-25-14
14 cm / 5 1/2"
Packed in plastic pouch

2/3
2/3
2/3
2/3



710-26-04
Complete set consisting:
1 Handle and 4 tips packed
in plastic pouch

1/2
Standard
710-27-15
15 cm / 6"

1/2
Standard
710-28-15
15 cm / 6"
With magnifying glass

2/3
Luer
710-29-14
14 cm / 5 1/2"



Dix
711-01-15
15 cm / 6"



Dix
711-02-15
15 cm / 6"



Dix
711-03-15
15 cm / 6"



Dix
711-04-15
15 cm / 6"



711-05-15
15 cm / 6"



711-06-15
15 cm / 6"



711-07-13
13 cm / 5 1/8"



711-08-13
13 cm / 5 1/8"



711-09-16
16 cm / 6 1/4"



711-10-16
16 cm / 6 1/4"



711-11-11
11 cm / 4 1/4"



Bowman
711-13-12
12 cm / 4 3/4"



Bowman
711-14-12
12 cm / 4 3/4"



Schweigger
711-15-12
12 cm / 4 3/4"

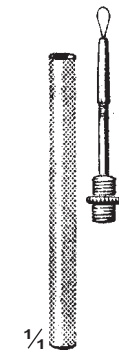

711-12-07
7 cm / 2 3/4"

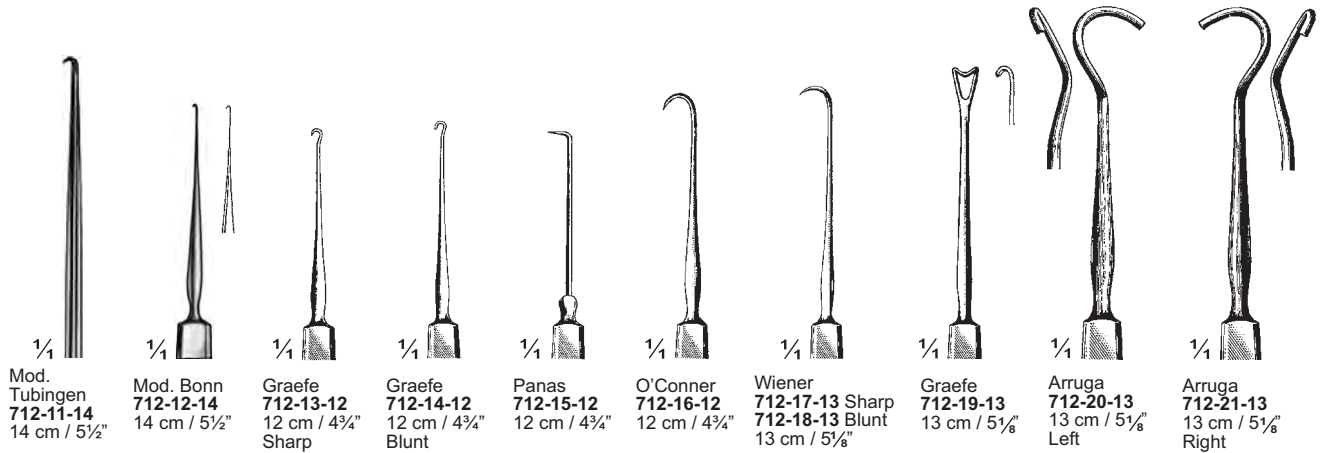
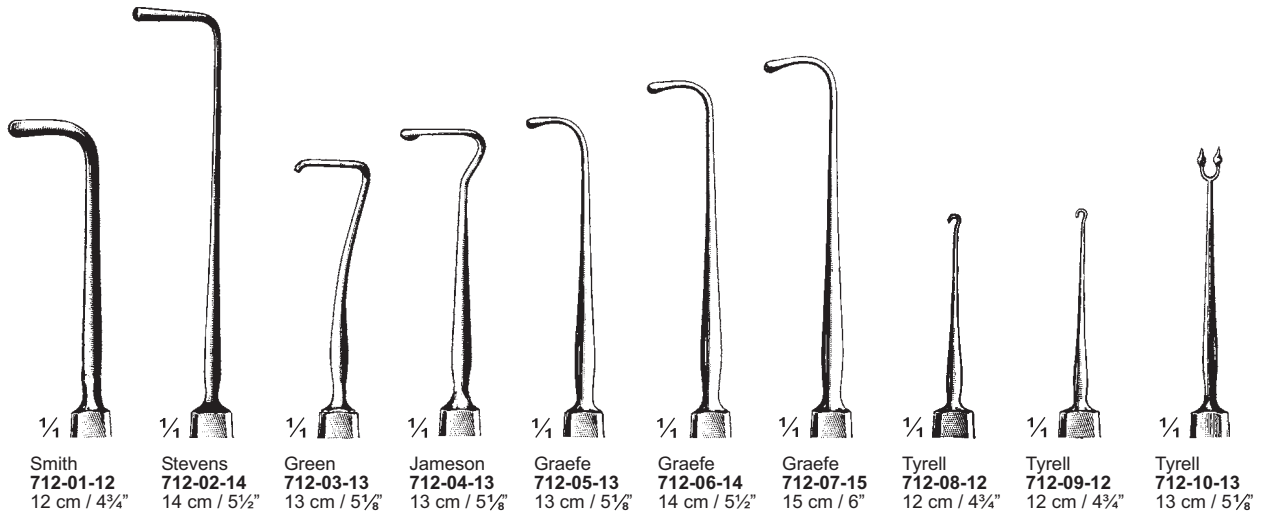

712-01-12 To 712-32-13

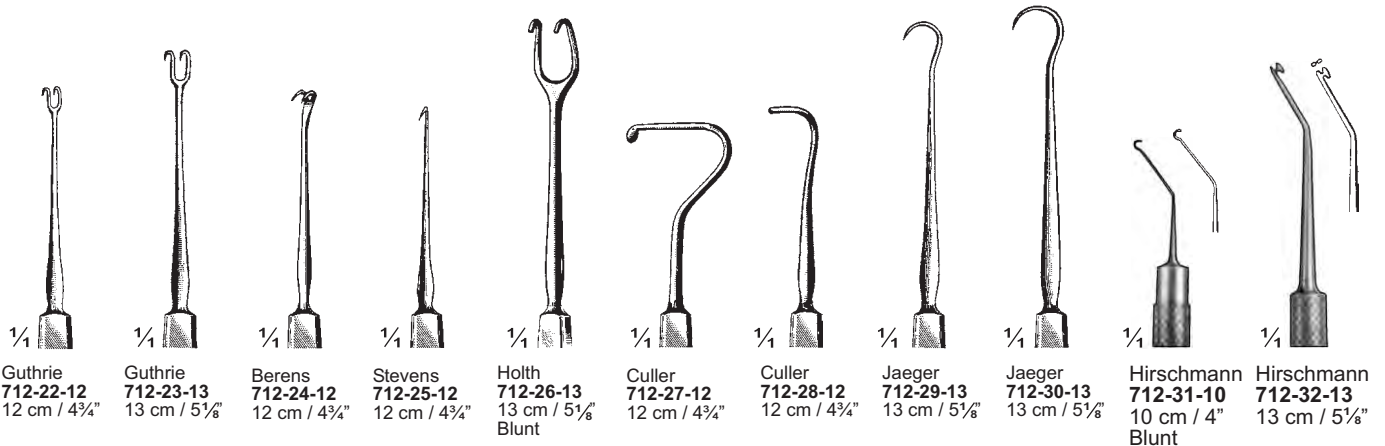

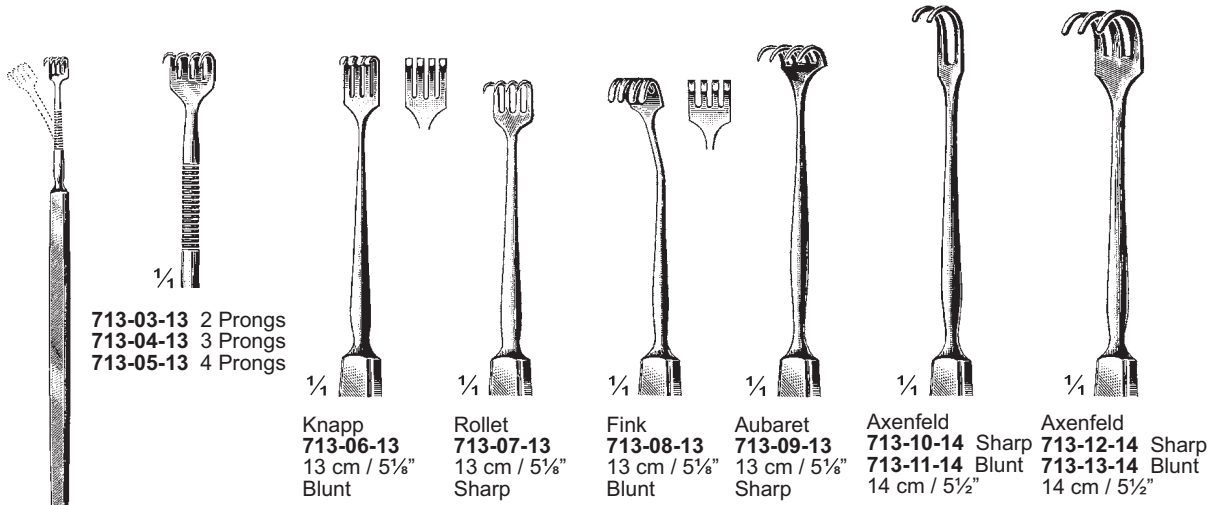

713-03-13 To 713-05-13
 13 cm / 5 1/8"
 Flexible shaft



1/4
 713-01-10 Left
 713-02-10 Right
 10.5 cm / 4 1/8"

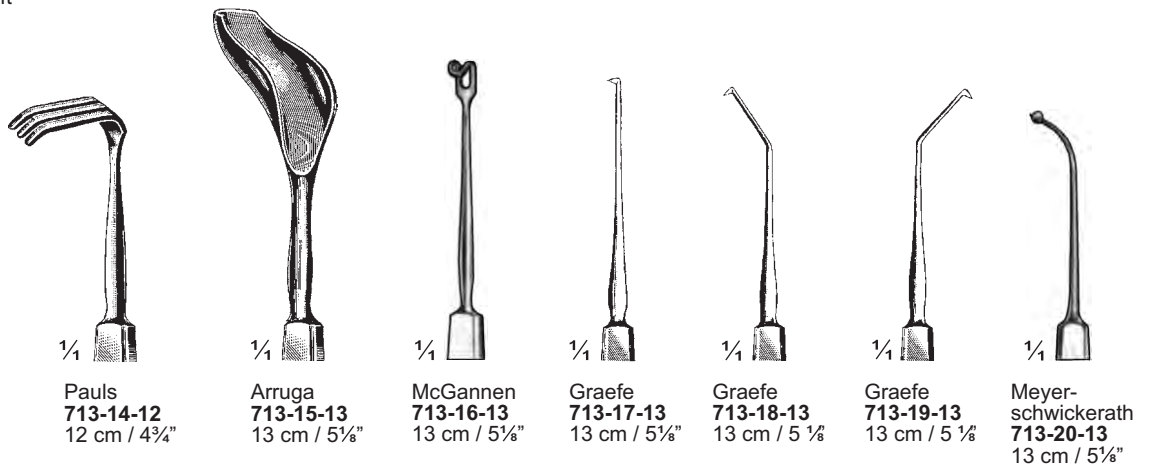



Bangerter
714-01-14
714-01-14 To 714-14-09
14 cm / 5½"

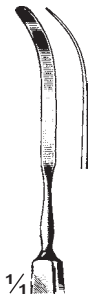

Weber
714-02-12
12 cm / 4¾"



Wecker
714-03-13
13 cm / 5 ⅛"

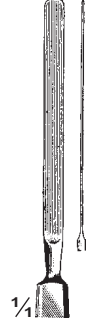

Wecker
714-04-13
13 cm / 5 ⅛"



Stock
714-05-13
13 cm / 5 ⅛"



Stock
714-06-13
13 cm / 5 ⅛"

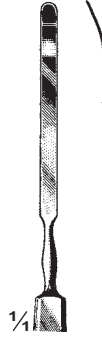

Culler
714-07-13
13 cm / 5 ⅛"



Suker
714-08-14
14 cm / 5½"



714-09-13₈
13 cm / 5"

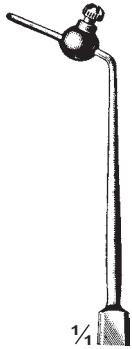

Wills-Hospital
714-10-13
13 cm / 5 ⅛"

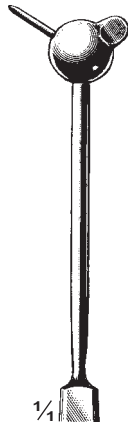

Wadsworth-Todd
714-11-14
14 cm / 5½"



Prince
714-12-14
14 cm / 5½"

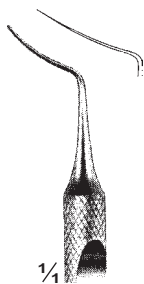

Castroviejo
714-13-09
9 cm / 3½"



Castroviejo
714-14-09
9.5 cm / 3¾"



Castroviejo
714-15-15
15 cm / 6"

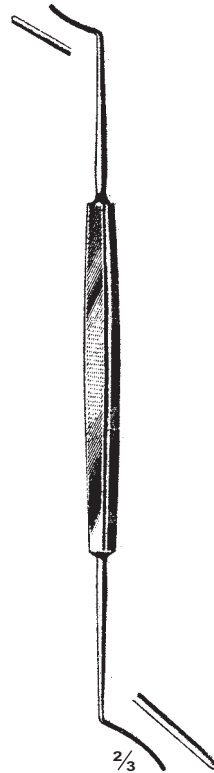

Castroviejo
714-16-15 0.50 mm
714-17-15 0.75 mm
714-18-15 1.00 mm
15 cm / 6"

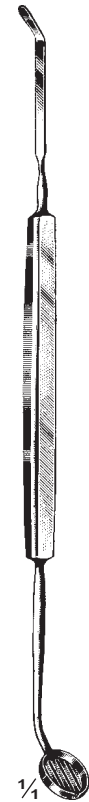

Castroviejo
714-19-14
14 cm / 5½"



Dastoor
714-20-14
14 cm / 5½"

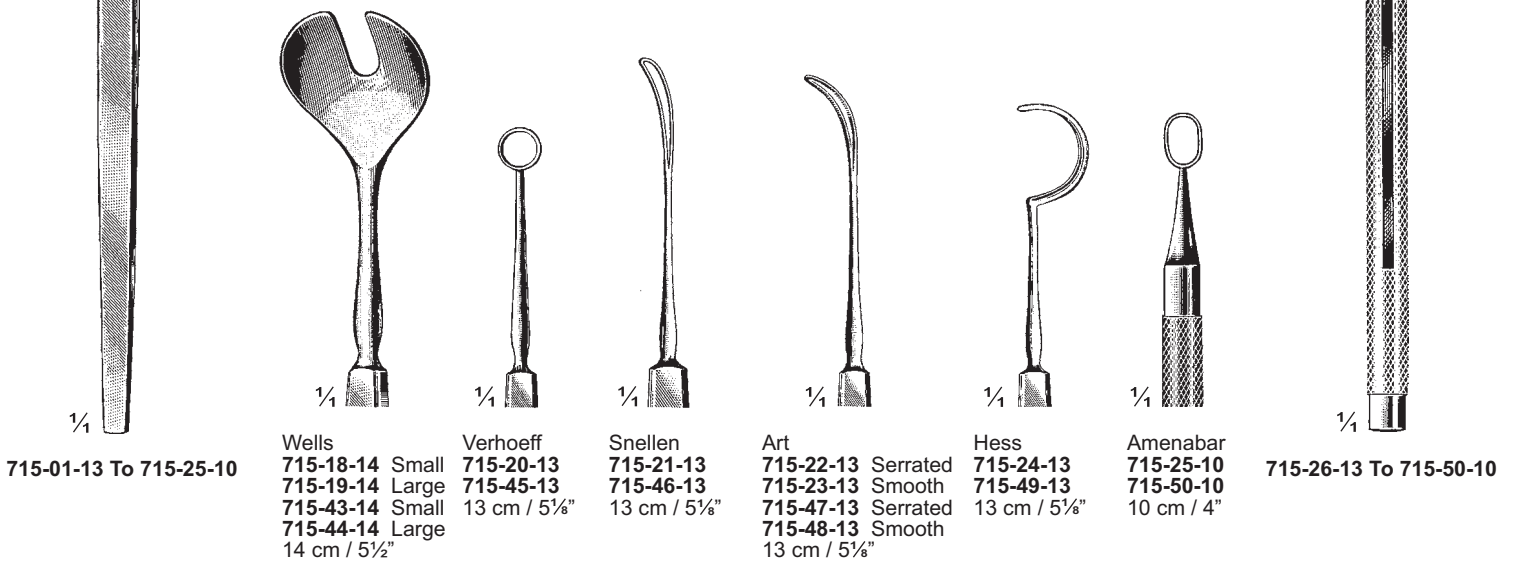
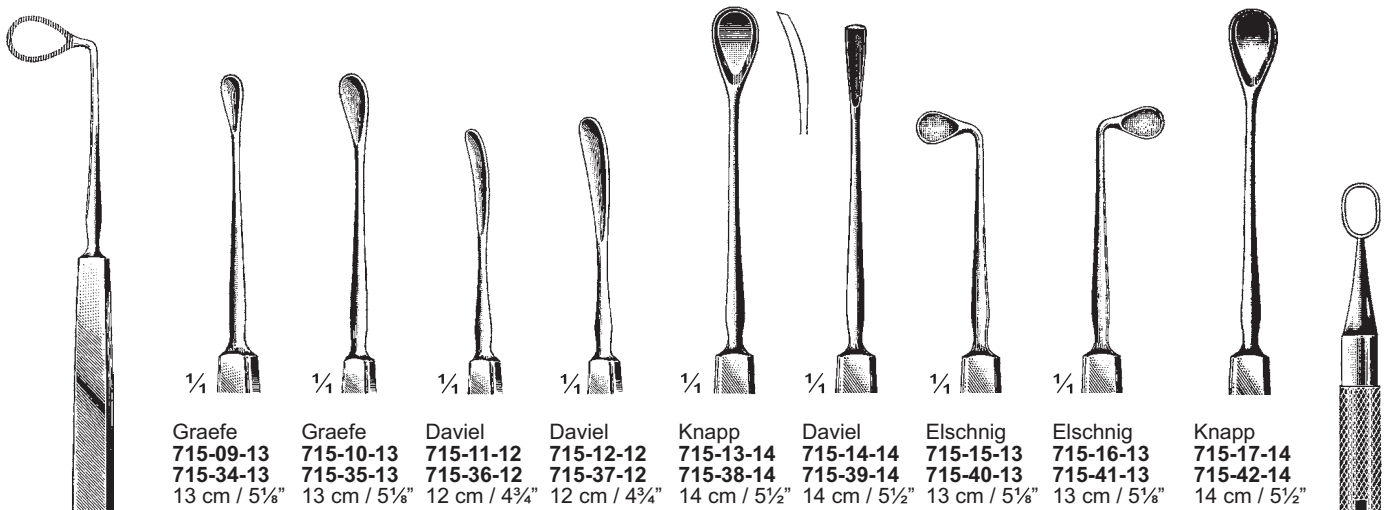
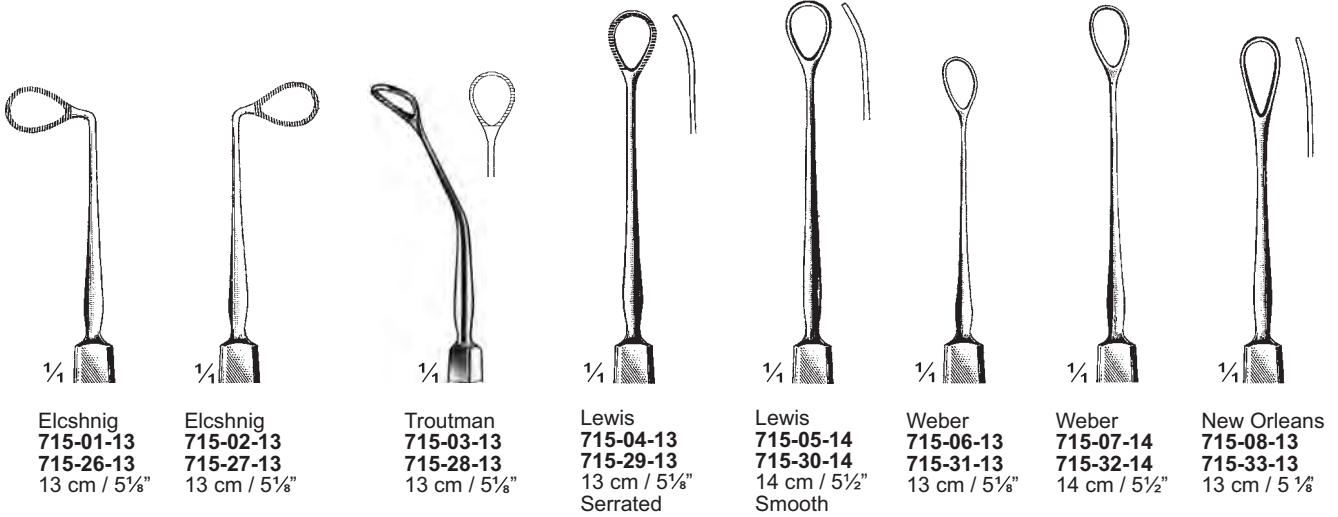

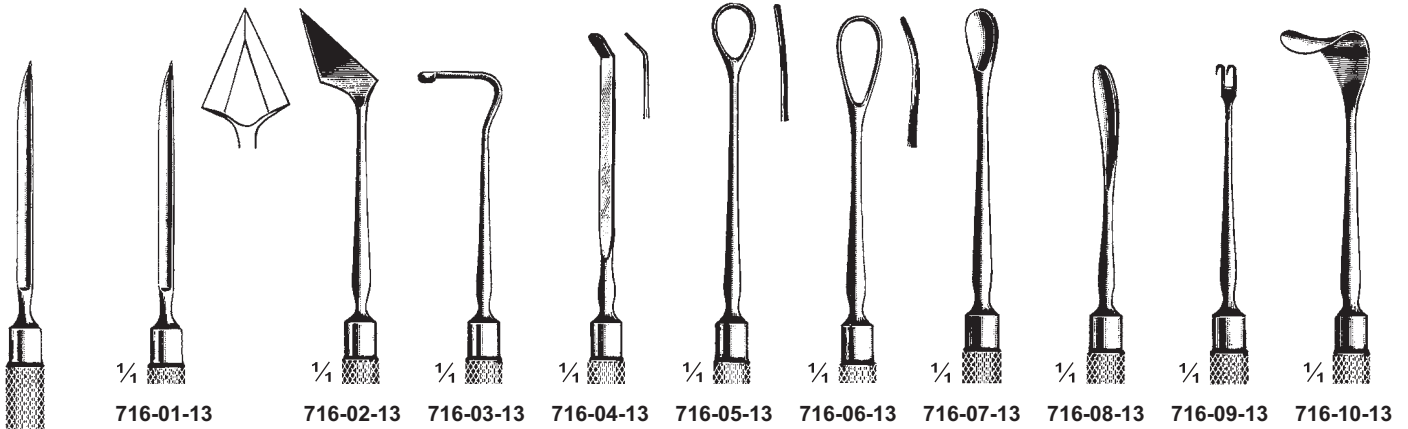

Kirby
716-01-13 To 716-10-13
13.5 cm / 5 1/4"

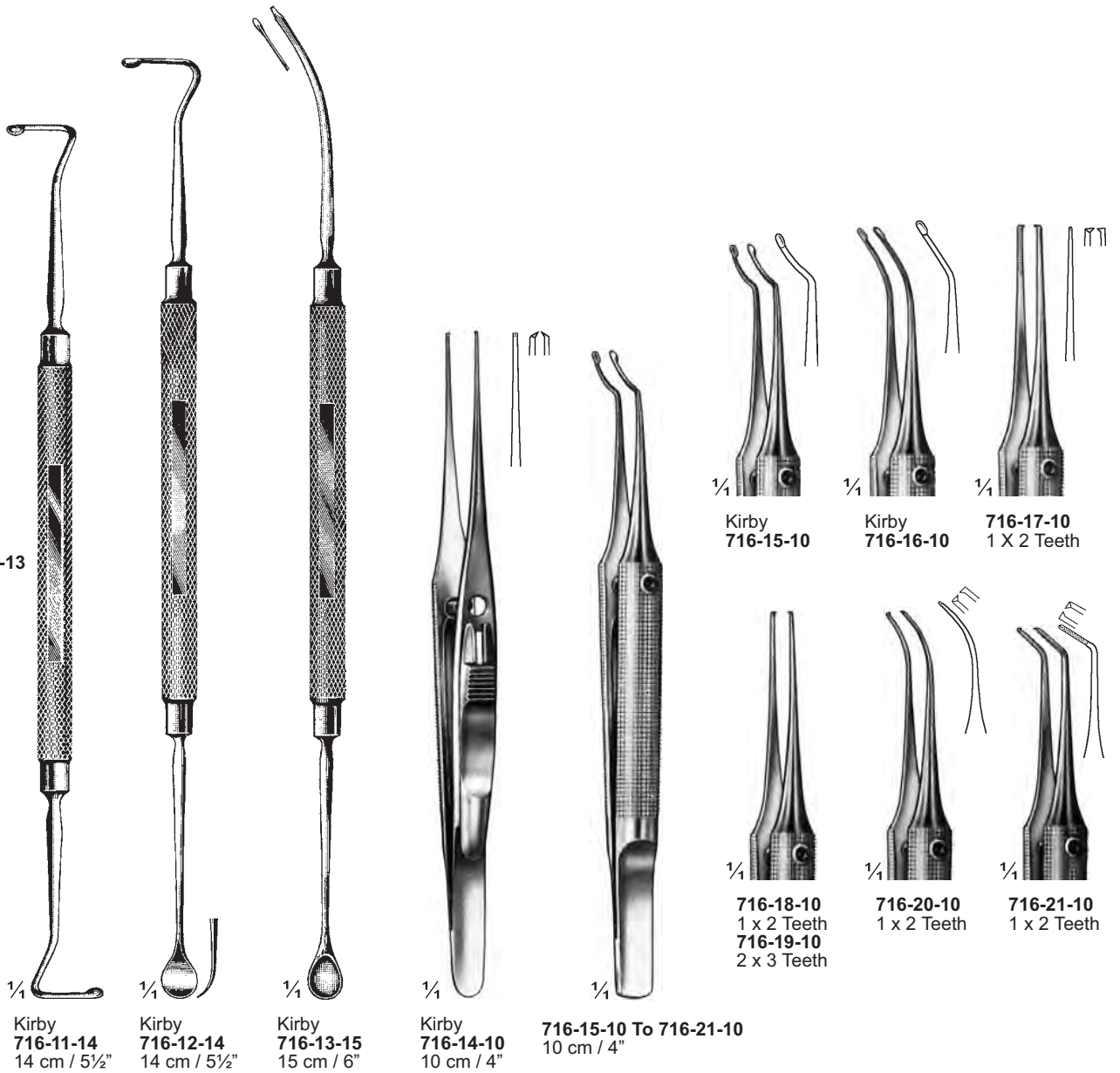



Meyhoefer
717-01-12 To 717-08-13

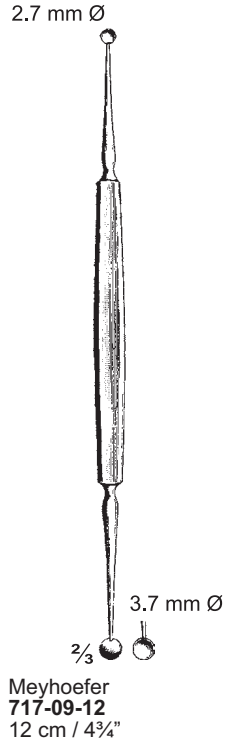
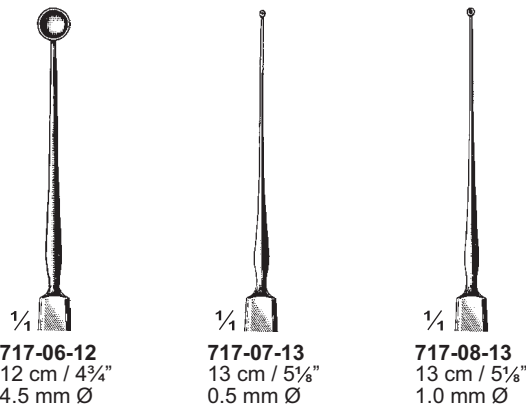
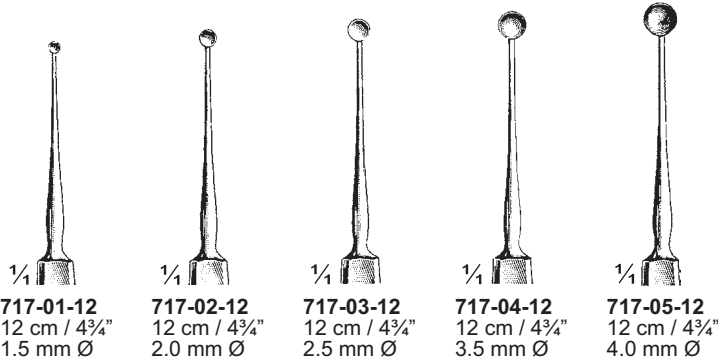

717-10-12 To 717-23-12

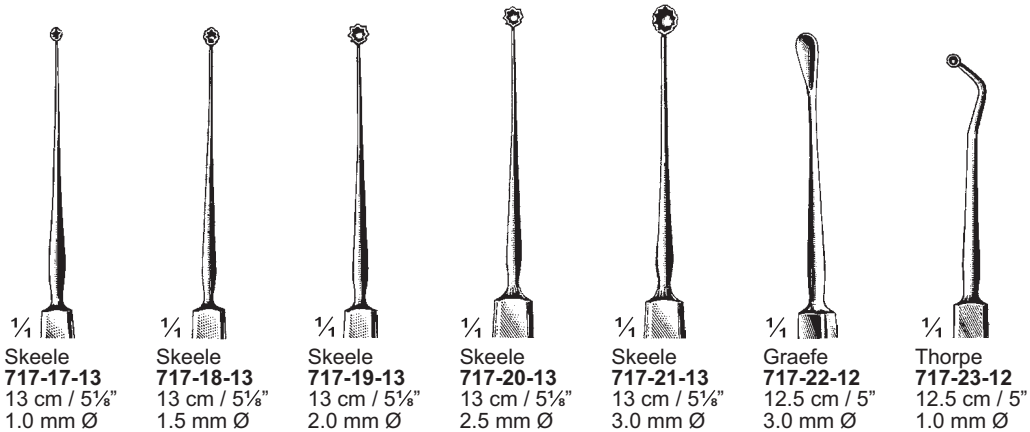
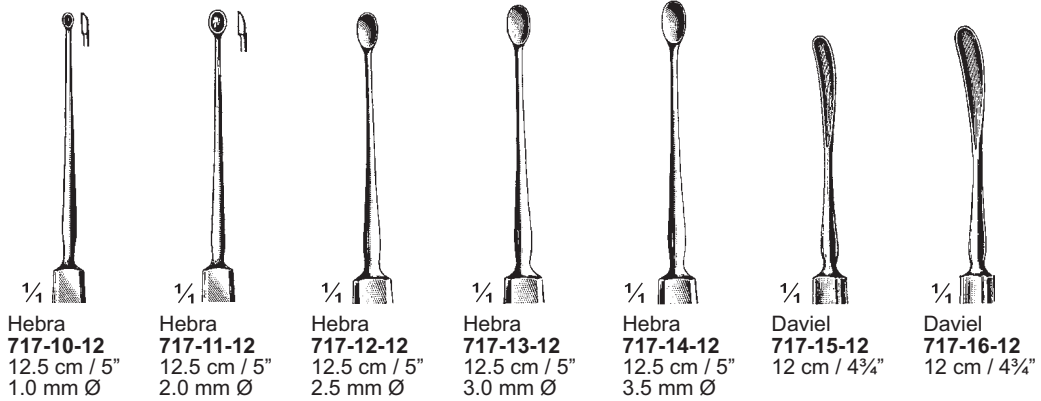



Heath
718-01-11 To 718-04-11
11.5 cm / 4½"



¼
718-01-11



¼
718-02-11



¼
718-03-11



¼
718-04-11



Axenfeld
718-05-13
13 cm / 5¼"



Axenfeld
718-06-12
12 cm / 4¾"



Axenfeld
718-07-12
12 cm / 4¾"



Lang
718-08-13
13 cm / 5⅛"



Bunge
718-08-13 to 718-13-14
14 cm / 5½"



¼
Bunge
718-09-14
14 cm / 5½"



¼
Bunge
718-10-14
14 cm / 5½"



¼
Bunge
718-11-14
14 cm / 5½"



¼
Bunge
718-12-14
14 cm / 5½"

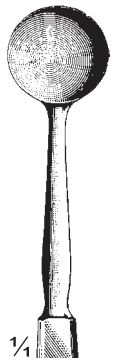

¼
Bunge
718-13-14
14 cm / 5½"

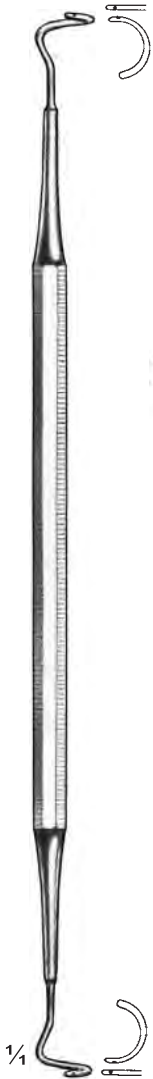

719-01-14
14.5 cm / 5 $\frac{3}{4}$ "



Harms 719-02-04
4.5 cm / 1 $\frac{3}{4}$ "



Harms 719-03-04
4.5 cm / 1 $\frac{3}{4}$ "



719-04-05
5 cm / 2"



719-05-05
5 cm / 2"



719-06-07
7.5 cm / 3"



719-07-07
7.5 cm / 3"



Mackensen 719-08-09
9 cm / 3 $\frac{1}{2}$ "



Mackensen 719-09-09
9 cm / 3 $\frac{1}{2}$ "



719-10-07 To 719-15-07
7 cm / 2 $\frac{3}{4}$ "



719-10-07
Fig. 00
0.7 mm Ø



719-11-08
Fig. 0
0.8 mm Ø



719-12-09
Fig. 1
0.9 mm Ø



719-13-01
Fig. 2
1.1 mm Ø



719-14-01
Fig. 3
1.3 mm Ø



719-15-01
Fig. 2
1.4 mm Ø



Ziegler 719-16-11
11 cm / 4 $\frac{1}{4}$ "

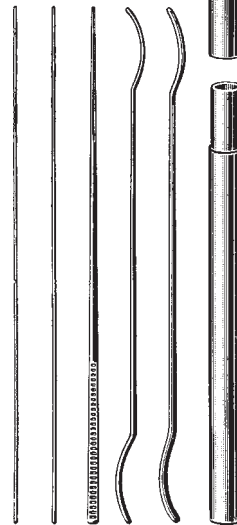

Bowmann 719-17-14
14 cm / 5 $\frac{1}{2}$ "
Complete with 5 probes
and 1 holder



Rolf 719-18-15
15 cm / 6"



719-19-18
18 cm / 7"

Stainless	Silver
720-01-000 Fig. 000	720-10-000
720-02-00 Fig. 00	720-11-00
720-03-0 Fig. 0	720-12-0
720-04-01 Fig. 1	720-13-01
720-05-02 Fig. 2	720-14-02
720-06-03 Fig. 3	720-15-03
720-07-04 Fig. 4	720-16-04
720-08-05 Fig. 5	720-17-05
720-09-06 Fig. 6	720-18-06

Stainless	Silver
720-31-00 Fig. 00-0	720-36-00
720-32-01 Fig. 1-2	720-37-01
720-33-03 Fig. 3-4	720-38-03
720-34-05 Fig. 5-6	720-39-05
720-35-07 Fig. 7-8	720-40-07

Stainless	Silver
720-41-00 Fig. 00-00	720-51-00
720-42-0 Fig. 0-0	720-52-0
720-43-01 Fig. 1-1	720-53-01
720-44-02 Fig. 2-2	720-54-02
720-45-03 Fig. 3-3	720-55-03
720-46-04 Fig. 4-4	720-56-04
720-47-05 Fig. 5-5	720-57-05
720-48-06 Fig. 6-6	720-58-06
720-49-07 Fig. 7-7	720-59-07
720-50-08 Fig. 8-8	720-60-08

Stainless	Silver
720-19-0000 Fig. 0000-000	720-25-0000
720-20-00 Fig. 00-1	720-26-00
720-21-01 Fig. 1-2	720-27-01
720-22-03 Fig. 3-4	720-28-03
720-23-05 Fig. 5-6	720-29-05
720-24-07 Fig. 7-8	720-30-07



Galezowsky
720-01-000 To 720-18-06
7.5 cm / 3"



Bowmann
720-19-0000 To 720-30-07
13 cm / 5 1/8"



Bowmann (Williams)
720-31-00 To 720-40-07
13 cm / 5 1/8"



Bowmann
720-41-00 To 720-60-08
13 cm / 5 1/8"

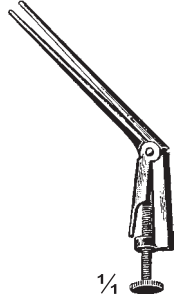

1/4
Galezowsky
720-61-04
4 cm / 1 1/2"



2/3
Wilder
720-62-11
11 cm / 4 1/4"



2/3
Wilder
720-63-11
11 cm / 4 1/4"



2/3
Wilder
720-64-11
11 cm / 4 1/4"



2/3
Simpson
720-65-10
10.5 cm / 4 1/8"



2/3
Simpson
720-66-10
10.5 cm / 4 1/8"



1/4
Ravertino
720-67-08
8.5 cm / 3 1/4"



1/4
Muldoon
720-68-10
10 cm / 4"



1/4
Castroviejo
720-69-12
12.5 cm / 5"



Ziegler
721-01-01 To 721-03-05
14 cm / 5½"

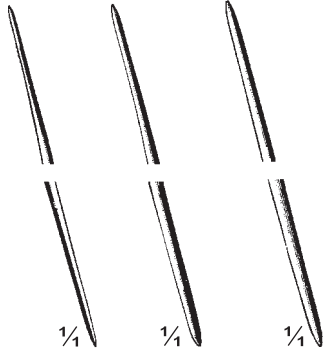

721-01-01 Fig. 1-2
721-02-03 Fig. 3-4
721-03-05 Fig. 5-6



2/3
Paton
721-04-15
15 cm / 6"

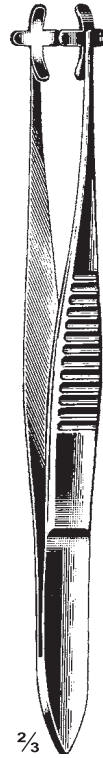

2/3
Berens
721-05-15
15 cm / 6"



1/4
1.5 mm Ø



1/4
2.0 mm Ø



1/4
Elliot
721-06-00
Complete with
1 Handle
2 Trephines 1.5 mm Ø
2 Trephines 2.0 mm Ø

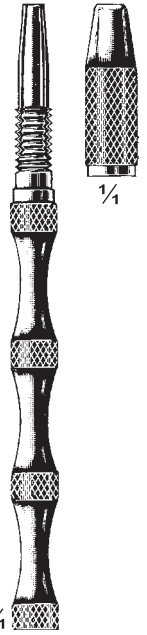

1/4
Arruga
721-07-08
8.5 cm / 3¼"

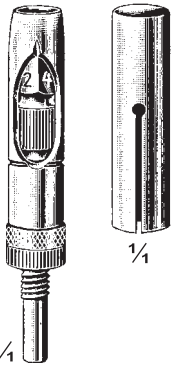

Castroviejo
721-08-05 To 721-16-11
5 cm / 2"

- 721-08-05 5.0 mm Ø
- 721-09-05 5.5 mm Ø
- 721-10-06 6.0 mm Ø
- 721-11-06 6.5 mm Ø
- 721-12-07 7.0 mm Ø
- 721-13-08 8.0 mm Ø
- 721-14-09 9.0 mm Ø
- 721-15-10 10.0 mm Ø
- 721-16-11 11.0 mm Ø

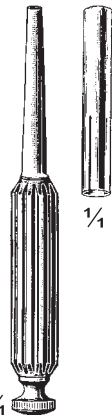

Stephenson
721-17-01 1.0 mm Ø
721-18-01 1.5 mm Ø
721-19-01 1.75 mm Ø
721-20-02 2.0 mm Ø
721-21-02 2.5 mm Ø
721-22-03 3.0 mm Ø
5.5 cm / 2½"

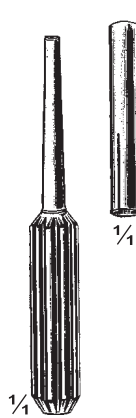

Elliot
721-23-01 1.0 mm Ø
721-24-01 1.5 mm Ø
721-25-02 2.0 mm Ø
5 cm / 2"



Grieshaber
721-26-01 1.0 mm Ø
721-27-01 1.5 mm Ø
721-28-02 2.0 mm Ø
721-29-02 2.5 mm Ø
721-30-03 3.0 mm Ø
6.5 cm / 2½"



Arruga
721-31-06 6 mm Ø
721-32-07 7 mm Ø
721-33-08 8 mm Ø
721-34-09 9 mm Ø
721-35-10 10 mm Ø
5 cm / 2"



Arruga
721-36-06 6 mm Ø
721-37-07 7 mm Ø
721-38-08 8 mm Ø
721-39-09 9 mm Ø
721-40-10 10 mm Ø
5 cm / 2"

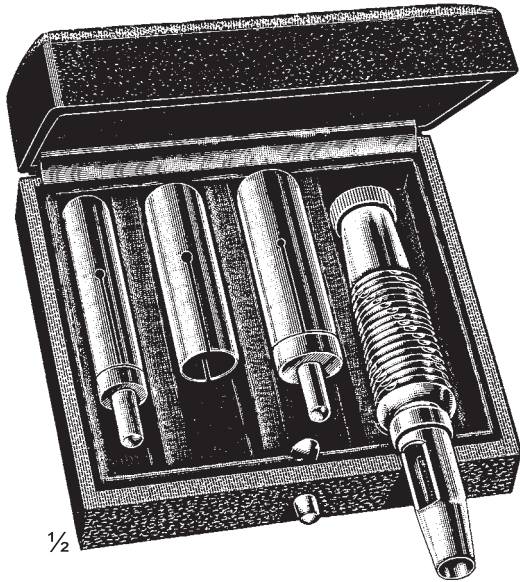

1/2

Castroviejo
722-01-00
Complete consisting :
1 Castroviejo trephine 4.5 mm Ø
1 Castroviejo trephine 5.5 mm Ø
1 Castroviejo trephine 6.5 mm Ø
Packed in wooden case



Castroviejo
722-02-00
Complete consisting :
1 Castroviejo trephine 5.0 mm Ø
1 Castroviejo trephine 6.0 mm Ø
1 Castroviejo trephine 6.5 mm Ø
Packed in stainless steel case

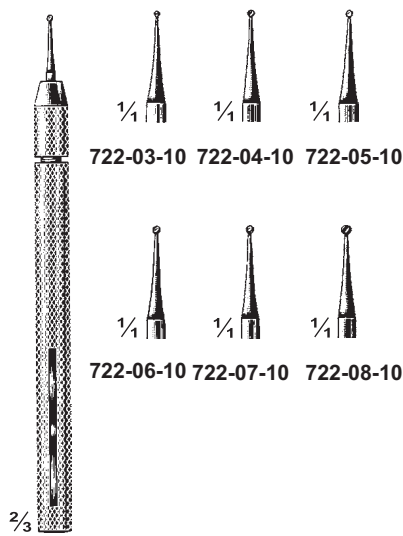

722-03-10 722-04-10 722-05-10

722-06-10 722-07-10 722-08-10

2/3

Storz
722-03-10 To 722-08-10
10.5 cm / 4 1/8"
722-09-06
Complete set with
6 tips

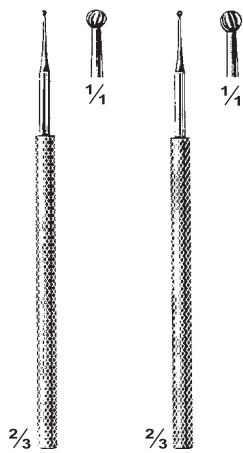

1/4

1/4

2/3

2/3

722-10-09
9 cm / 3 1/2"

722-11-09
9 cm / 3 1/2"

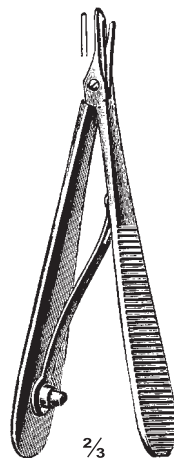

2/3

Haitz
722-12-09
9 cm / 3 1/2"

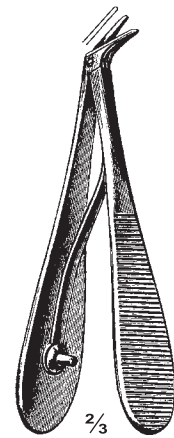

2/3

Holth
722-13-09
9 cm / 3 1/2"

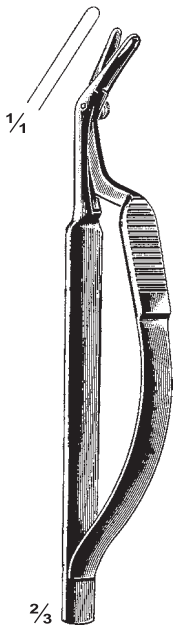

1/4

2/3

Lagrange
722-14-12
12 cm / 4 3/4"



$\frac{1}{4}$
West
723-01-16
16 cm / 6 $\frac{1}{4}$ "



$\frac{1}{4}$
West
723-02-16
16 cm / 6 $\frac{1}{4}$ "



$\frac{2}{3}$
Castroviejo
723-06-15
Range 15 mm



$\frac{2}{3}$
Castroviejo
723-07-20
Range 20 mm



Castroviejo-Schachar
723-08-20
Range 20 mm

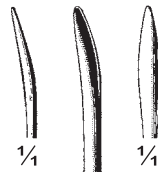

$\frac{1}{4}$
Lueneburg
723-03-12
12 cm / 4 $\frac{3}{4}$ "

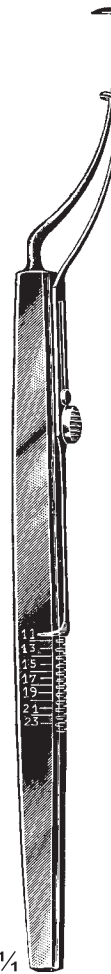

$\frac{1}{4}$
Connin-Amsler
723-04-13
13 cm / 5 $\frac{1}{8}$ "

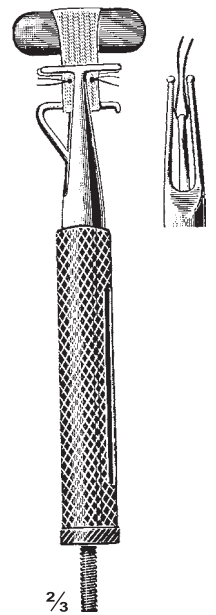

$\frac{2}{3}$
Bishop
723-05-12
12 cm / 4 $\frac{3}{4}$ "

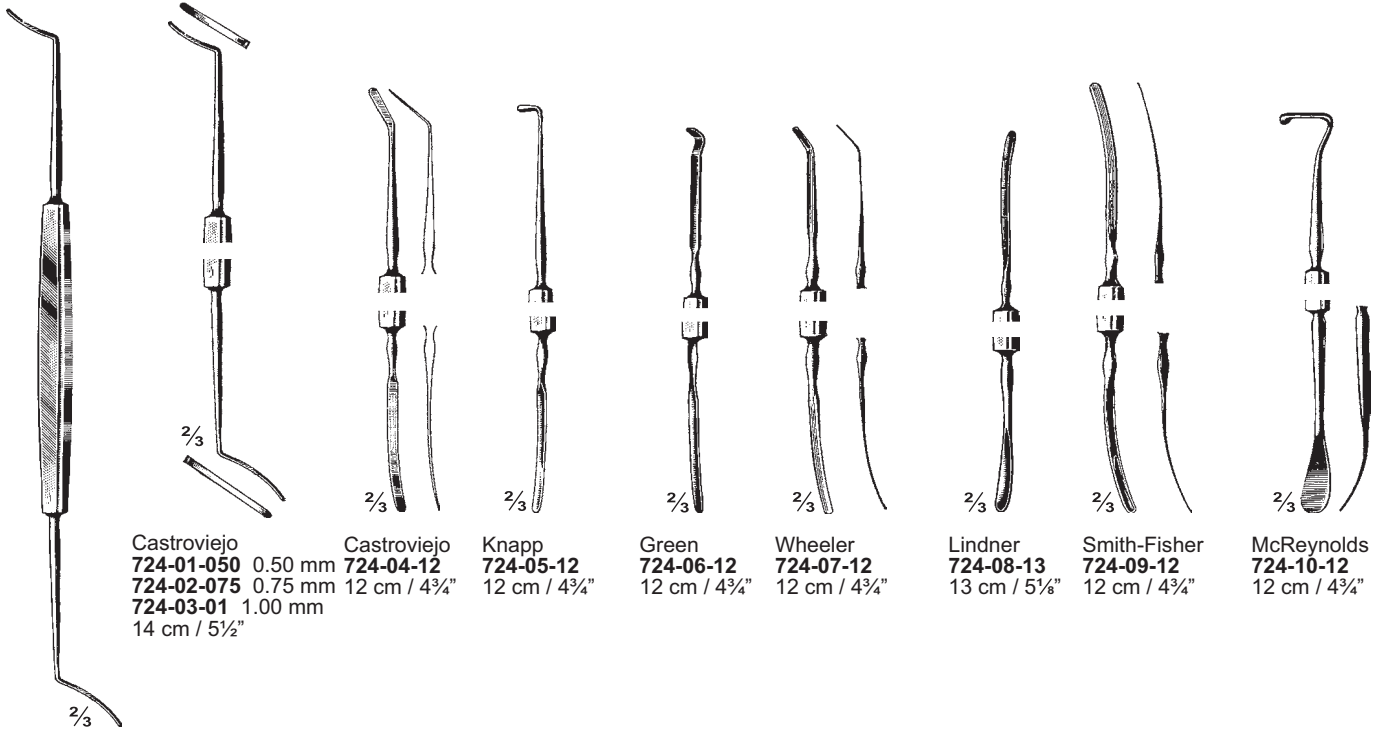

Castroviejo 724-01-050 0.50 mm 724-02-075 0.75 mm 724-03-01 1.00 mm 14 cm / 5½"	Castroviejo 724-04-12 12 cm / 4¾"	Knapp 724-05-12 12 cm / 4¾"	Green 724-06-12 12 cm / 4¾"	Wheeler 724-07-12 12 cm / 4¾"	Lindner 724-08-13 13 cm / 5⅝"	Smith-Fisher 724-09-12 12 cm / 4¾"	McReynolds 724-10-12 12 cm / 4¾"
---------------------------------------------------------------------------------------------	-----------------------------------------	-----------------------------------	-----------------------------------	-------------------------------------	-------------------------------------	------------------------------------------	----------------------------------------

724-01-050 To 724-19-14

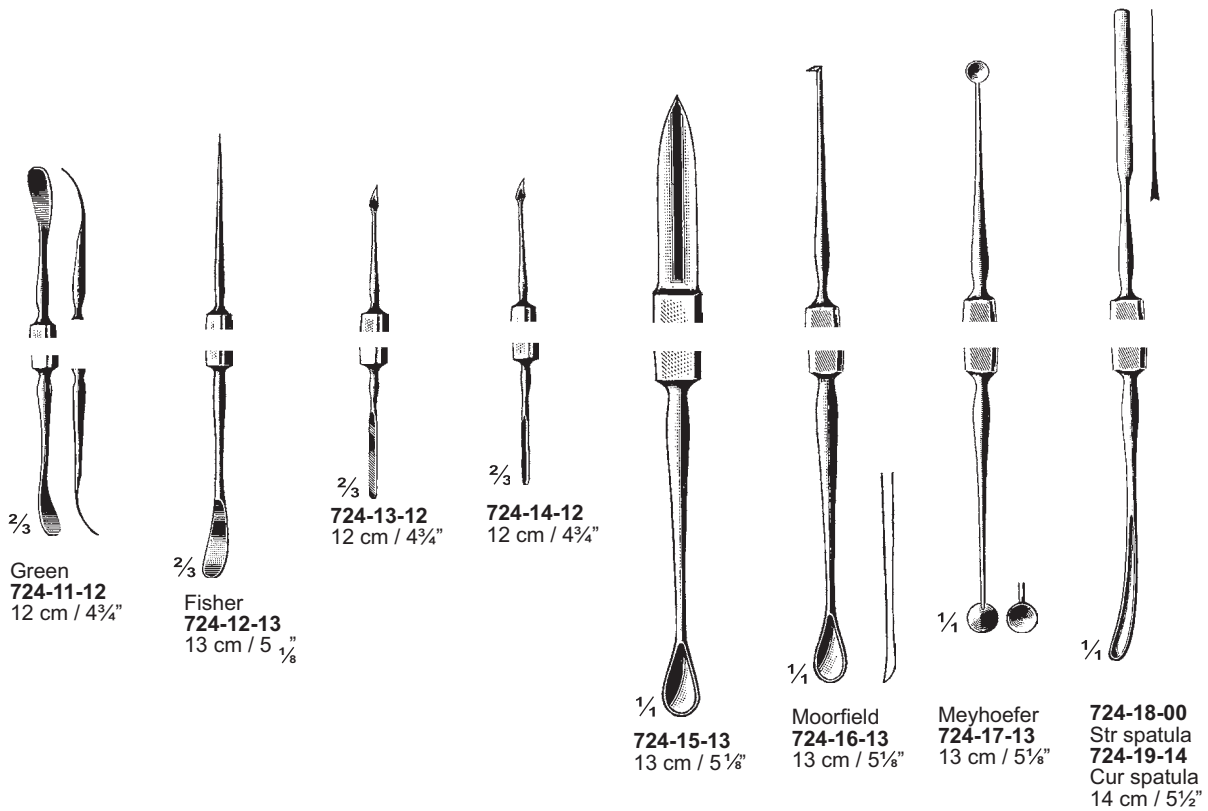

Green 724-11-12 12 cm / 4¾"	Fisher 724-12-13 13 cm / 5⅛"	724-13-12 12 cm / 4¾"	724-14-12 12 cm / 4¾"	724-15-13 13 cm / 5⅝"	Moorfield 724-16-13 13 cm / 5⅝"	Meyhoefer 724-17-13 13 cm / 5⅝"	724-18-00 Str spatula 724-19-14 Cur spatula 14 cm / 5½"
-----------------------------------	------------------------------------	--------------------------	--------------------------	--------------------------	---------------------------------------	---------------------------------------	---------------------------------------------------------------------

All items also available in Titanium

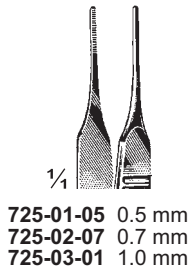
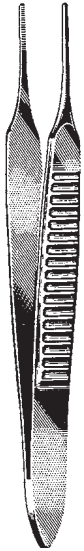

725-01-05 0.5 mm
725-02-07 0.7 mm
725-03-01 1.0 mm

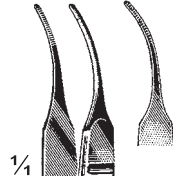

725-04-05 0.5 mm
725-05-07 0.7 mm
725-06-01 1.0 mm

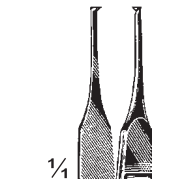

725-07-05 0.5 mm
725-08-07 0.7 mm
725-09-01 1.0 mm
1 X 2 Teeth

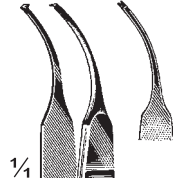

725-10-05 0.5 mm
725-11-07 0.7 mm
725-12-01 1.0 mm
1 X 2 Teeth

Graefe
725-01-05 To 725-12-01
7 cm / 2 3/4"



Bishop-Harman
725-13-08
8.5 cm / 3 1/2"
Fine points

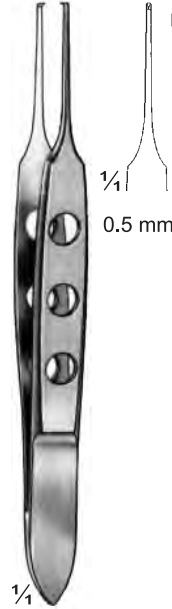

Bishop-Harman
725-14-08
8.5 cm / 3 1/2"
1 X 2 Teeth
Fine points

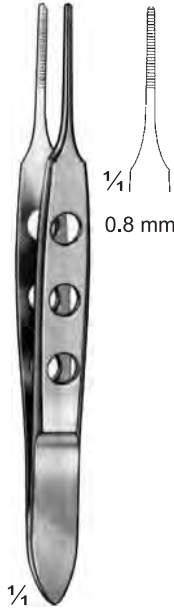

Bishop-Harman
725-15-08
8.5 cm / 3 1/2"

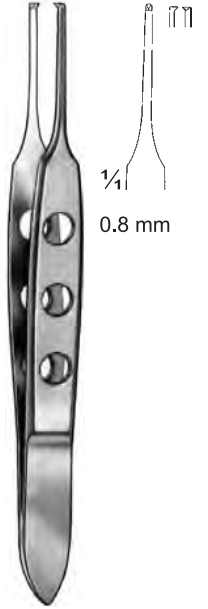

Bishop-Harman
725-16-08
8.5 cm / 3 1/2"
1 X 2 Teeth

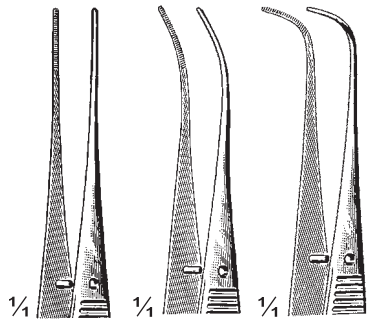
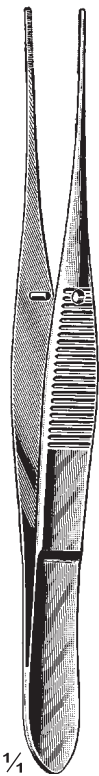

725-17-07 7 cm / 2 3/4"
725-19-07 7 cm / 2 3/4"
725-21-07 7 cm / 2 3/4"
725-18-10 10 cm / 4"
725-20-10 10 cm / 4"
725-22-10 10 cm / 4"

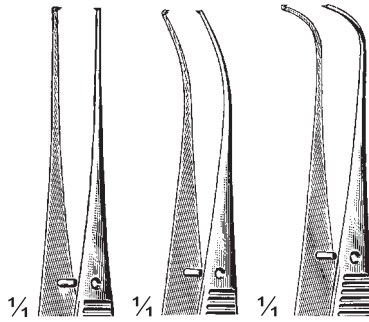

725-23-07 7 cm / 2 3/4"
725-25-07 7 cm / 2 3/4"
725-27-07 7 cm / 2 3/4"
725-24-10 10 cm / 4"
725-26-10 10 cm / 4"
725-28-10 10 cm / 4"
1 X 2 Teeth 1 X 2 Teeth 1 X 2 Teeth

Graefe
725-17-07 To 725-28-10



Stevens
725-29-10 To 725-34-10
10.5 cm / 4 1/8"

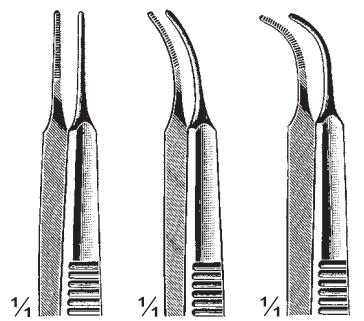

725-29-10 725-30-10 725-31-10

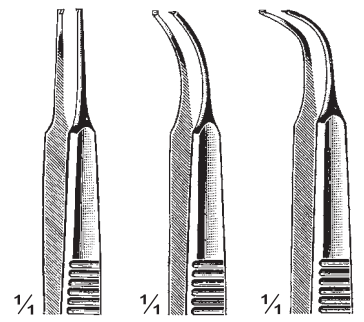

725-32-10 1 X 2 Teeth
725-33-10 1 X 2 Teeth
725-34-10 1 X 2 Teeth

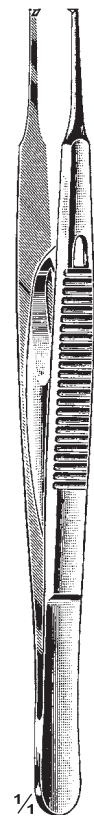

Stevens
725-35-11 To 725-36-11
11 cm / 4 1/4"

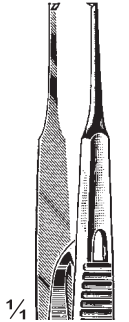

725-35-11

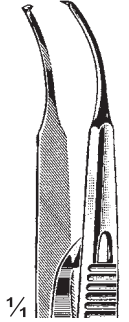

725-36-11
1 X 2 Teeth

All items also available in Titanium

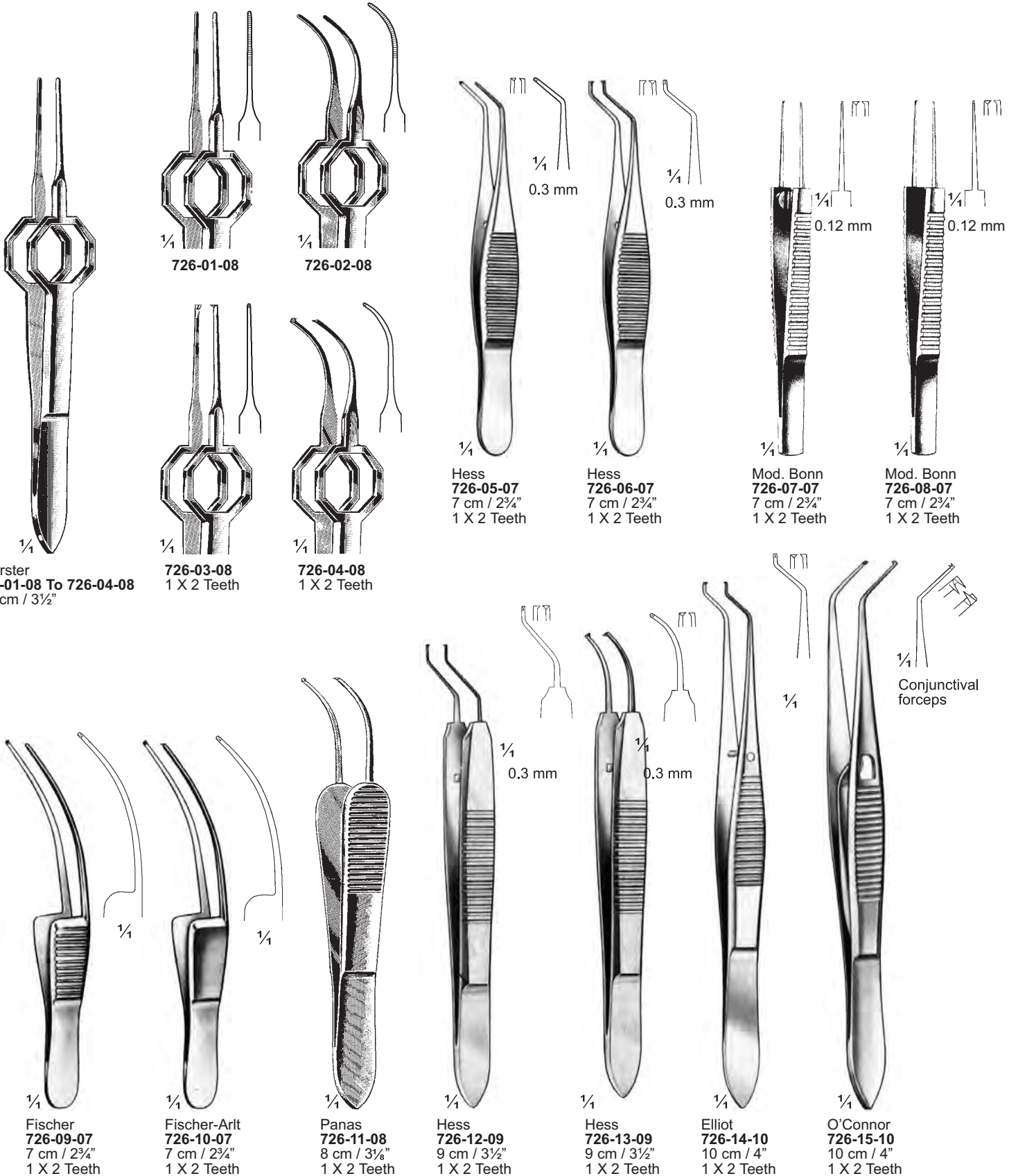



Mod. Bonn
727-01-10
10 cm / 4"
1 X 2 Teeth

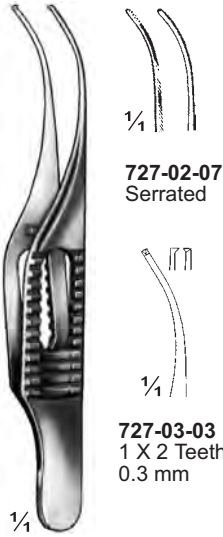

Gill
727-02-07 To 727-03-03
7.5 cm / 3"

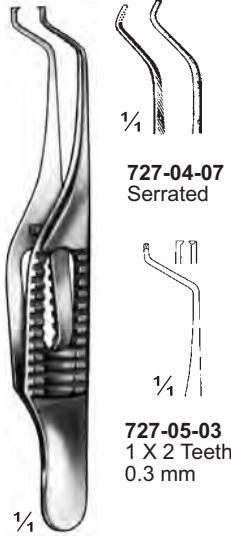

Gill-Hess
727-04-07 To 727-05-03
7.5 cm / 3"

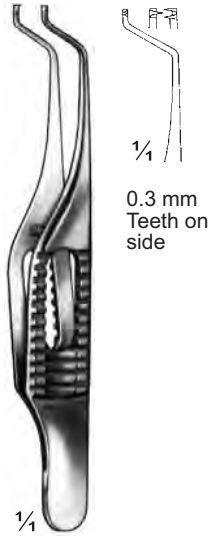

Gill-Hess
727-06-07
7.5 cm / 3"
1 X 2 Teeth

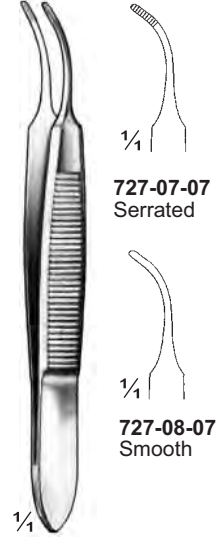

Chandler
727-07-07 To 727-08-07
7 cm / 2 3/4"



Fuchs
727-09-07
7 cm / 2 3/4"
1 X 2 Teeth



727-10-04 To 727-14-12
7 cm / 2 3/4"

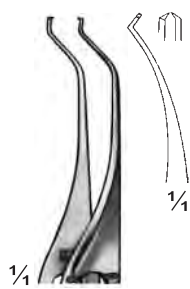

Barraquer-Katzin
727-10-04
1 X 2 Teeth
0.4 mm



Troutman (Colibri)
727-11-12
1 X 2 Teeth
0.12 mm



Barraquer (Colibri)
727-12-12
1 X 2 Teeth
0.12 mm

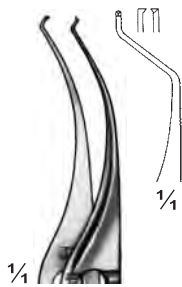

Barraquer-Katzin
(Colibri)
727-13-12
1 X 2 Teeth
0.12 mm



Barraquer (Colibri)
727-14-12
1 X 2 Teeth
0.12 mm



Castroviejo
727-15-01 To 727-18-02
9 cm / 3 1/2"

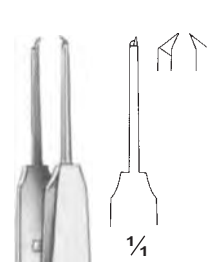

727-15-01
1 X 1 Teeth

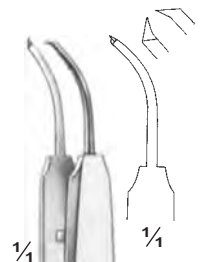

727-16-01
1 X 1 Teeth

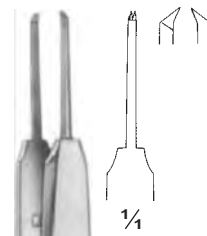

727-17-02
2 X 2 Teeth

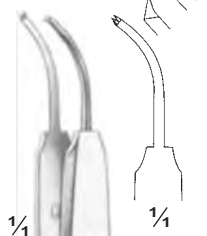

727-18-02
2 X 2 Teeth

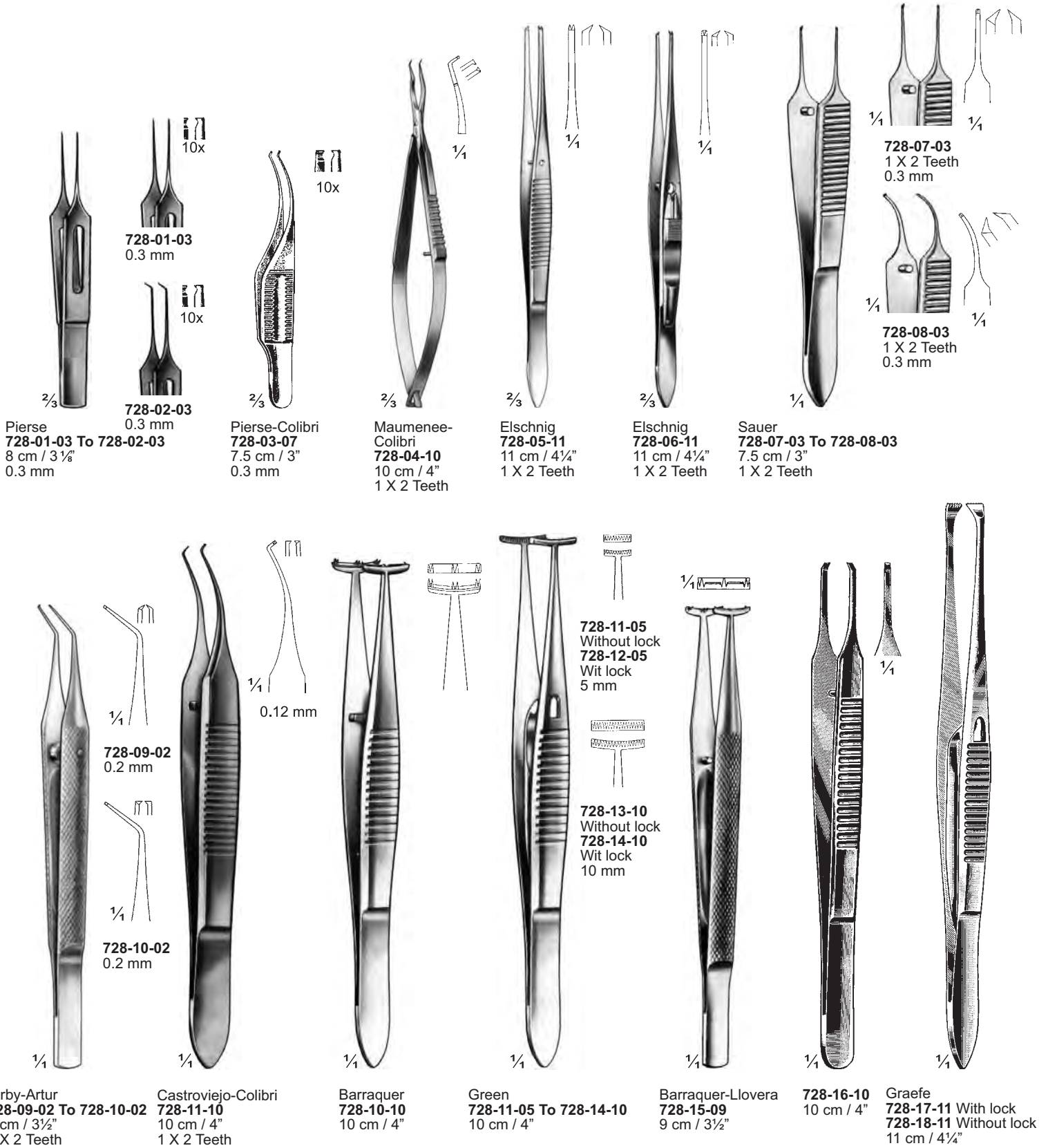



Clark-Verhoeff
729-01-11
11 cm / 4¼"

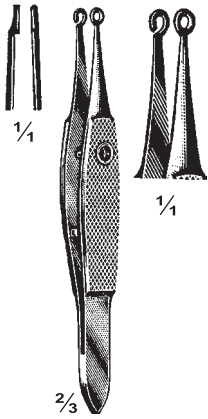

Verhoeff
729-02-08
8 cm / 3½"



Willard-Colibri
729-03-13
13 cm / 5½"

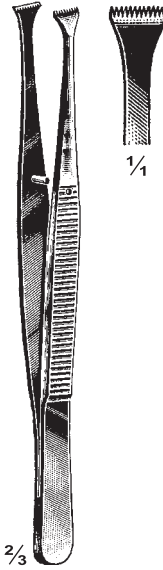

O'Brein
729-04-11
11 cm / 4¼"

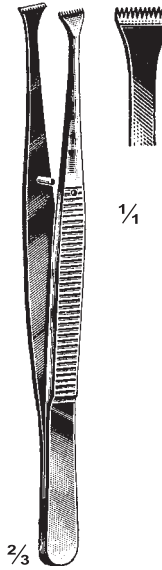

Waldau
729-05-11
11 cm / 4¼"

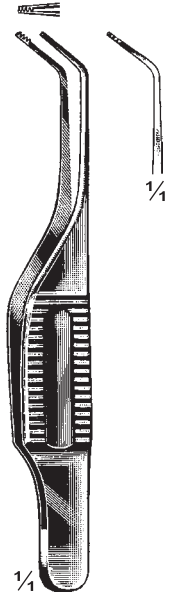

Gill-Fuchs
729-06-07
7.5 cm / 3"



Gill-Arruga
729-07-07
7.5 cm / 3"



Stock
729-08-09
9.5 cm / 3¾"



Swiss Mod.
729-09-09
9.5 cm / 3¾"



Terson
729-10-09
9 cm / 3½"



Schweigger
729-12-10
10 cm / 4"



Schweigger
729-11-10
10 cm / 4"

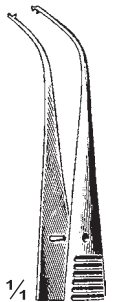

Foerster
729-13-10
10 cm / 4"

729-10-09 To 729-13-10



Fuchs
730-01-07
7 cm / 2 3/4"



Pley
730-02-07
7.5 cm / 3"

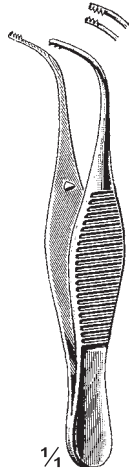

730-03-06
6 cm / 2 1/2"



Hess
730-04-06
6 cm / 2 1/2"



Hess
730-05-07
7 cm / 2 3/4"



Kalt
730-06-10
10 cm / 4"



Kalt
730-07
10 cm / 4"

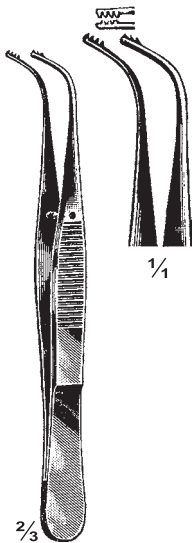

Elschnig
730-08-10
10 cm / 4"



Elschnig
730-09
10 cm / 4"



Castroviejo
730-10-10
10 cm / 4"



Castroviejo
730-11-10
10 cm / 4"



Arruga
730-12-10
10 cm / 4"



Arruga
730-13-10
10 cm / 4"

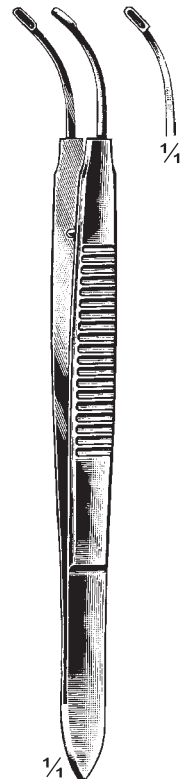

Arruga-Nizetic
730-14-10
10 cm / 4"



Terson
731-01-09
9.5 cm / 3¾"



Barraguer
731-02-10
10 cm / 4"



Choyce
731-03-10
10 cm / 4"



McPherson
731-04-08
8.5 cm / 3¼"



McPherson
731-05-08
8.5 cm / 3¼"

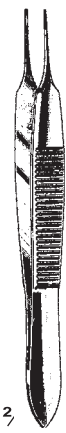

McPherson
731-06-08
8.5 cm / 3¼"
1 X 2 Teeth



McPherson
731-07-08
8.5 cm / 3¼"
1 X 2 Teeth



Safar
731-08-07
7 cm / 2¾"

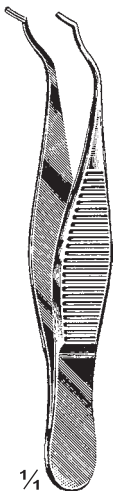

Green
731-09-06
6.5 cm / 2½"



Galin
731-10-12 To 731-13-40
12 cm / 4¾"

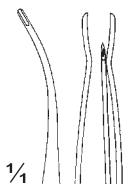

731-10-12 With irrigator
731-11-40 40° angled With irrigator
731-12-12 Without irrigator
731-13-40 40° angled Without irrigator



Clayman
731-14-12 With irrigator
731-15-12 Without irrigator
12.5 cm / 5"



Shepard
731-16-12 With irrigator
731-17-12 Without irrigator
12.5 cm / 5"



Shepard II
731-18-12 With irrigator
731-19-12 Without irrigator
12.5 cm / 5"



Binkhorst
732-01-07 With irrigator
732-02-07 Without irrigator
7 cm / 2 7/8"

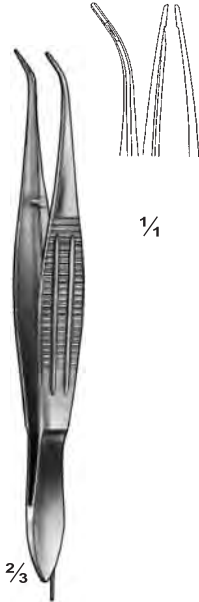

Hirschmann
732-03-10 With irrigator
732-04-10 Without irrigator
10 cm / 4"

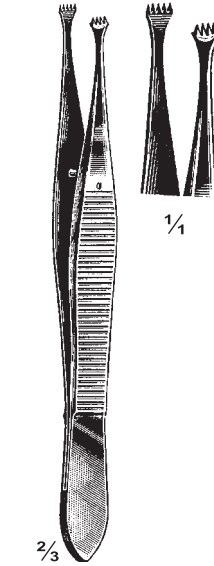

Schmidt-Rimpler
732-05-11
11 cm / 4 1/4"
4 X 5 Teeth

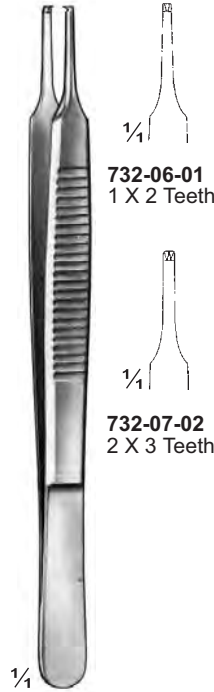

Lester
732-06-01 To 732-07-02
9 cm / 3 1/2"



732-06-01
1 X 2 Teeth

732-07-02
2 X 3 Teeth



732-07-11
11 cm / 4 1/4"
2 X 3 Teeth

732-08-11
11 cm / 4 1/4"
3 X 4 Teeth

Falcao
732-09-10
10 cm / 4"
1 X 2 Teeth

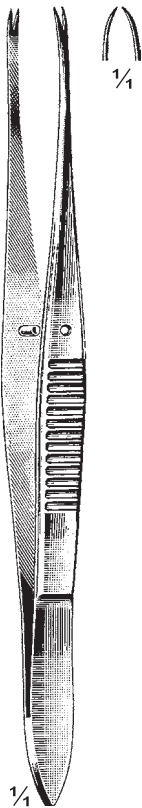

Guist
732-10-10
10.5 cm / 4 1/8"
2 X 2 Teeth

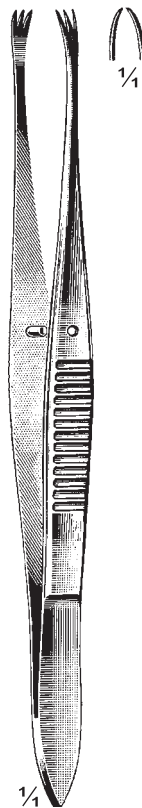

Guist
732-11-10
10.5 cm / 4 1/8"
3 X 3 Teeth



Kronfeld
732-12-08
8 cm / 3 1/8"

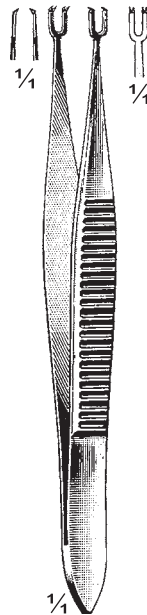

Kronfeld (Panas)
732-13-08
8 cm / 3 1/8"



Moorfield
732-14-10
10 cm / 4"



Alabaama-University
732-15-09
9 cm / 3 1/2"

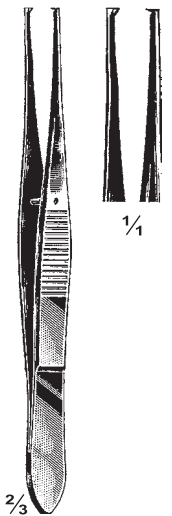

732-16-10
10 cm / 4"
1 X 2 Teeth

Width of teeth

733-02-12	0.12 mm	733-10-12
733-03-03	0.3 mm	733-11-03
733-04-05	0.5 mm	733-12-05
733-05-01	1.0 mm	733-13-01
733-06-01	1.5 mm	733-14-01

Width of teeth

733-07-05	0.5 mm	733-15-05
733-08-01	1.0 mm	733-16-01
733-09-01	1.5 mm	733-17-01

Dastoor
733-01-10
10 cm / 4"
1 X 2 Teeth

Castroviejo
733-02-12 To 733-09-01
10 cm / 4"
1 X 2 Teeth

Castroviejo
733-10-12 To 733-17-01
10 cm / 4"
1 X 2 Teeth

733-18-07
7 cm / 2¾"
1 X 2 Teeth

Girad
733-19-10
10 cm / 4"
1 X 2 Teeth

Girad
733-20-10
10 cm / 4"
1 X 2 Teeth

Barraquer Modif.
733-21-10
10.5 cm / 4¼"

733-22-10

733-23-10

733-24-10

733-25-10

733-26-10

733-27-09

733-28-09
1 X 2 Teeth

Tubingen
733-29-10

Bonn
733-30-01
1 X 2 Teeth
0.12 mm

Tubingen
733-31-10

Nugent
733-22-10 To 733-23-10
10 cm / 4"

Bonaccolto
733-24-10 To 733-25-10
10 cm / 4"

Mod. Tubingen
733-26-10
10 cm / 4"

McCullough
733-27-09 To 733-28-09
9.5 cm / 3¾"

733-29-10 To 733-31-10
10 cm / 4"

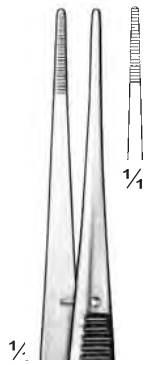

734-01-11

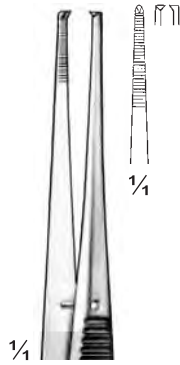

734-02-01
1 X 2 Teeth

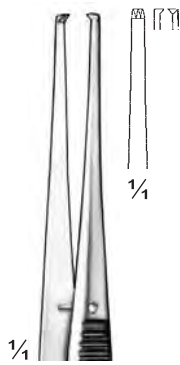

734-03-02
2 X 3 Teeth



734-04-08
8.5 cm / 3 1/4"



Paufigue
734-05-10
10 cm / 4"
1 X 2 Teeth

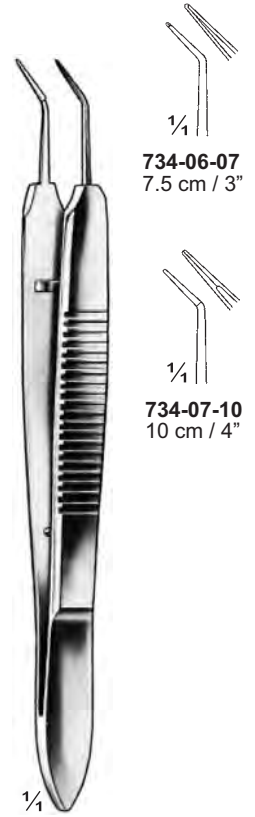

734-06-07
7.5 cm / 3"

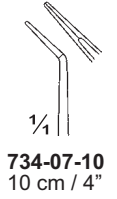

734-07-10
10 cm / 4"

734-01-11 To 734-03-02
11 cm / 4 1/4"



Bonaccolto
734-09-11
11 cm / 4 1/4"



Dastoor
734-10-10
10 cm / 4"
1 X 2 Teeth



734-11-10
10 cm / 4"
1 X 2 Teeth



Troutman-Rectus
734-12-08
8.5 cm / 3 1/4"
1 X 2 Teeth



Jameson
734-13-10
10 cm / 4"
Left



Jameson
734-14-10
10 cm / 4"
Right

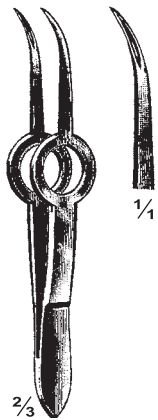

Schaaf
734-08-09
9 cm / 3 1/2"

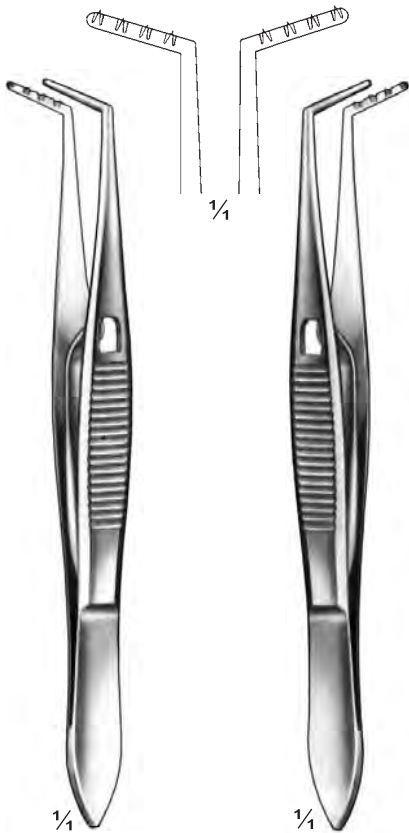

1/4
Sattler
735-01-10
10 cm / 4"

1/4
Sattler
735-02-10
10 cm / 4"

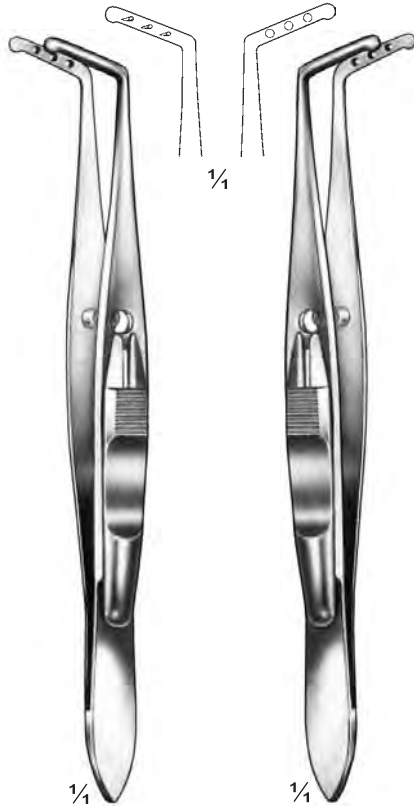

1/4
Prince
735-03-10
10 cm / 4"

1/4
Prince
735-04-10
10 cm / 4"

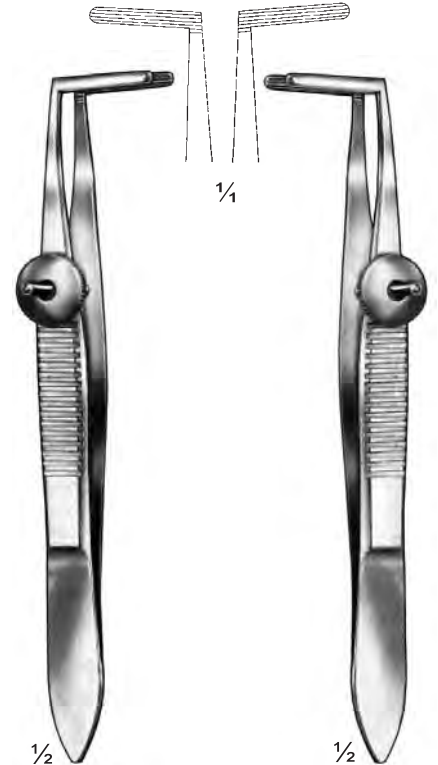

1/2
Blascovics
735-05-09
9 cm / 3 1/2"

1/2
Blascovics
735-06-09
9 cm / 3 1/2"

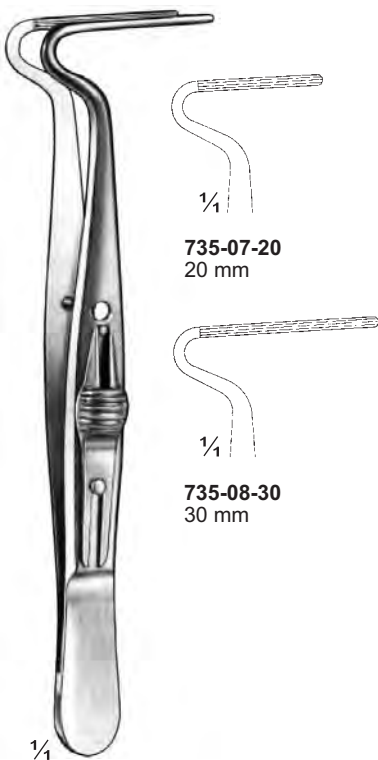

1/4
Berke
735-07-20 To 735-08-30
10 cm / 4"

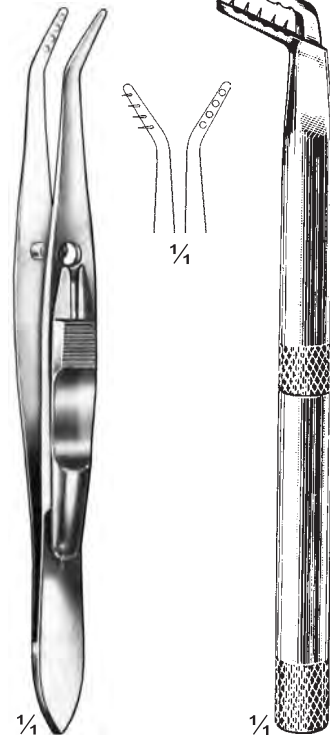
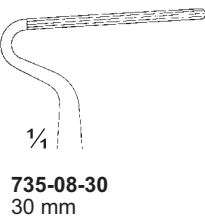
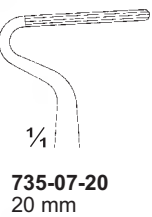

1/4
Fink-Jameson
735-09-10
10 cm / 4"

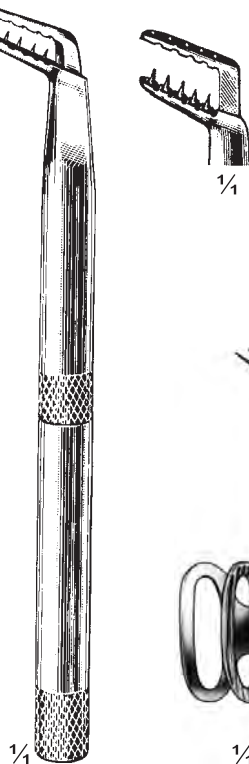
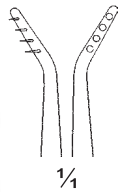

1/4
Berens
735-10-10
10 cm / 4"

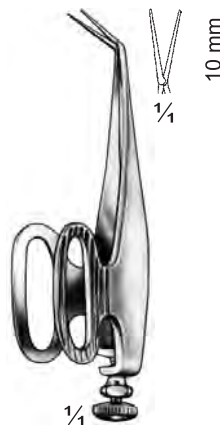

1/4
Barraquer
735-11-10
5.5 cm / 2 1/4"

10 mm

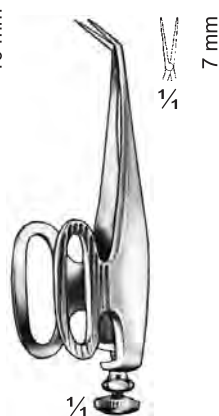

1/4
Barraquer
735-12-07
5.5 cm / 2 1/4"

7 mm

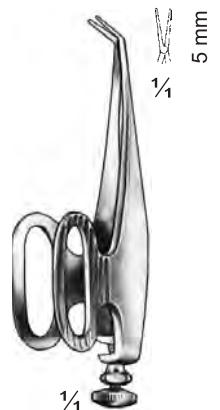

1/4
Barraquer
735-13-05
5.5 cm / 2 1/4"

5 mm



Elschnig
736-01-11
11 cm / 4 1/4"

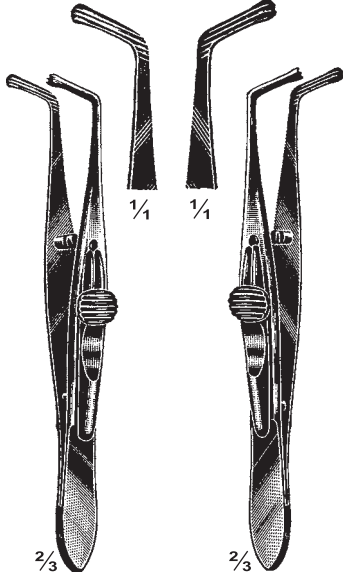

Worth
736-02-10
10 cm / 4"



Worth
736-03-10
10 cm / 4"

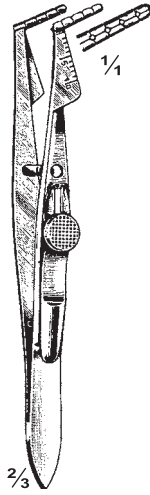

Barens
736-04-10
10 cm / 4"

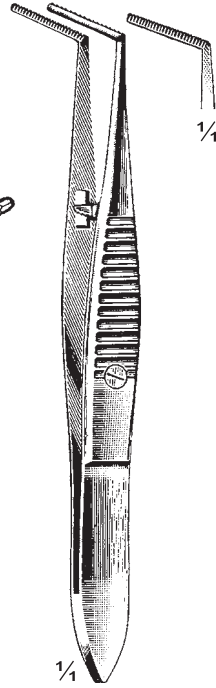

Reese
736-05-10
10 cm / 4"



Prince
736-06-09
9 cm / 3 1/2"

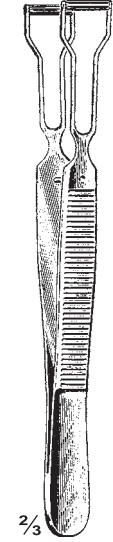
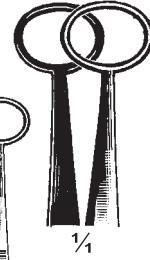

Knapp
736-07-11
11 cm / 4 1/4"

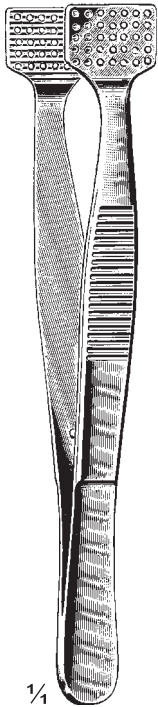
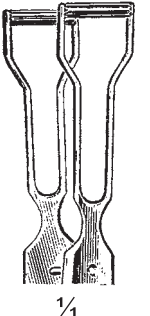

Kuhnt
736-08-09
9.5 cm / 3 3/4"

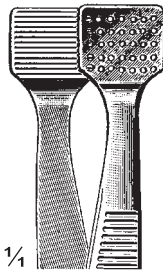

Kuhnt
736-09-09
9.5 cm / 3 3/4"



736-10-02 To 736-17-04
8 cm / 3 1/8"

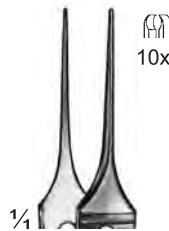

Dermor-Pierse
736-10-02
0.2 mm

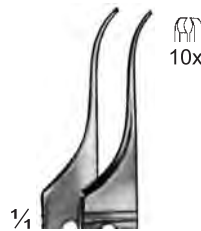

Dermor-Pierse
736-11-02
0.2 mm

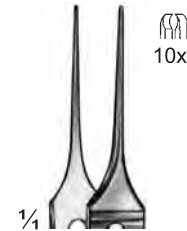

Dermor-Pierse
736-12-02
0.2 mm

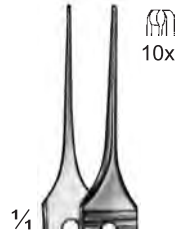

Dermor-Pierse
736-13-03
0.3 mm

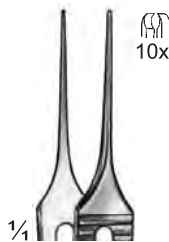

Dermor-Pierse
736-14-04
0.4 mm

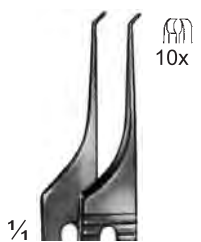

Dermor-Pierse (Colibri)
736-15-02
0.2 mm

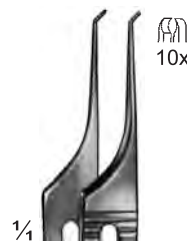

Dermor-Pierse (Colibri)
736-16-03
0.3 mm

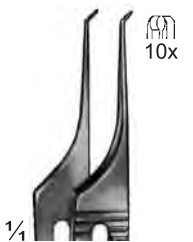

Dermor-Pierse (Colibri)
736-17-04
0.4 mm

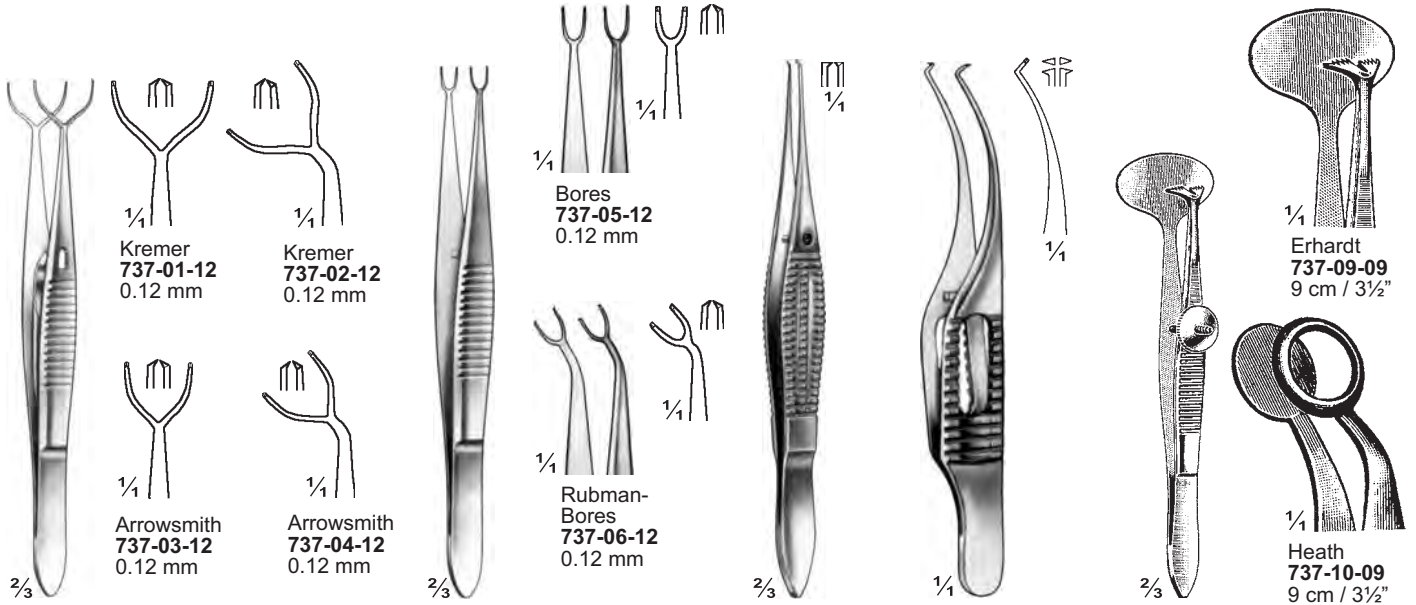

737-01-12 To 737-04-12
10 cm / 4"

737-05-12 To 737-06-12
10 cm / 4"

Bores
737-07-10
10 cm / 4"

737-08-07
7 cm / 2 $\frac{3}{4}$ "

737-09-09 To 737-10-09
9cm

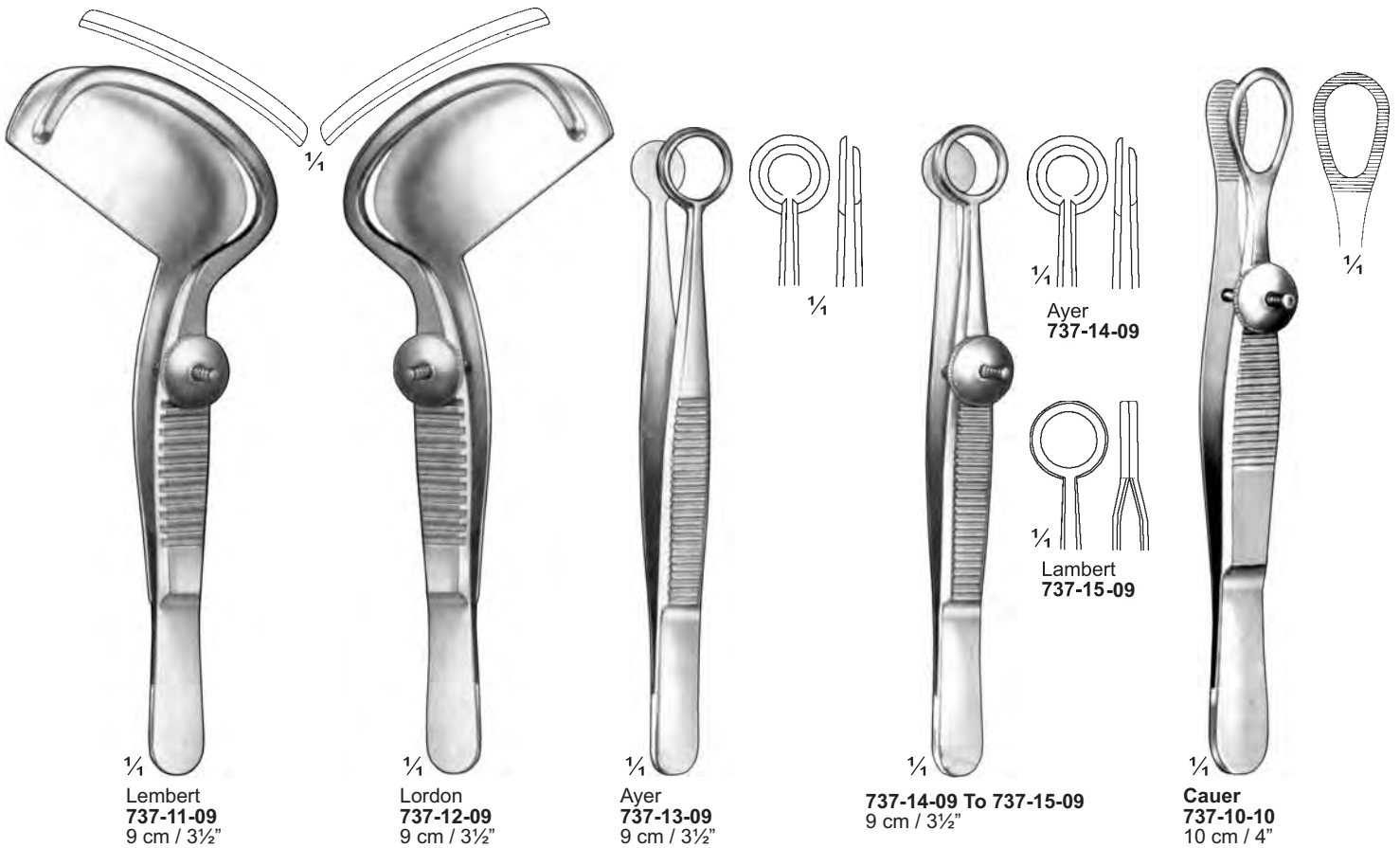



Desmarres
738-01-09 To 738-03-09
9 cm / 3½"



738-01-09

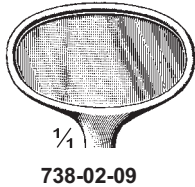

738-02-09

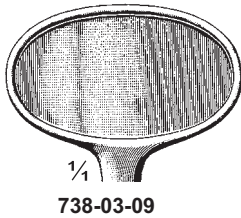

738-03-09

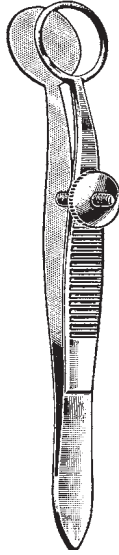

Hunt
738-04-09
9.5 cm / 3¾"

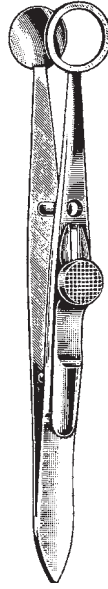

Spencer
738-05-10
10 cm / 4"

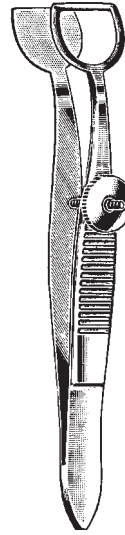

Weis
738-06-10
10 cm / 4"

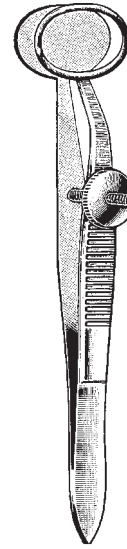

Francis
738-07-09
9.5 cm / 3¾"

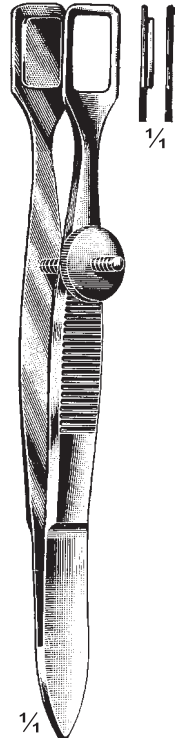

Weaver
738-08-10
10 cm / 4"



Lordan
738-09-09
9.5 cm / 3¾"

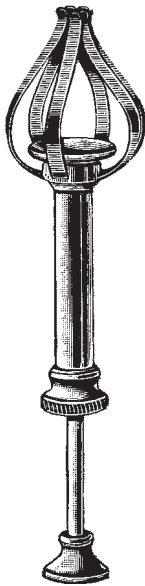

Carter
738-10-11
11 cm / 4¼"
Sphere introducer



Barraquer
738-11-05 5 mm Blade
738-12-07 7 mm Blade
738-13-10 10 mm Blade
5.5 cm / 2¼"



Troutman
738-14-10
10 cm / 4"
Left

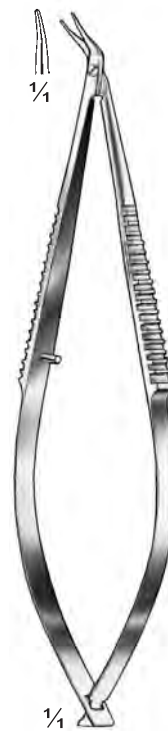

Troutman
738-15-10
10 cm / 4"
Right

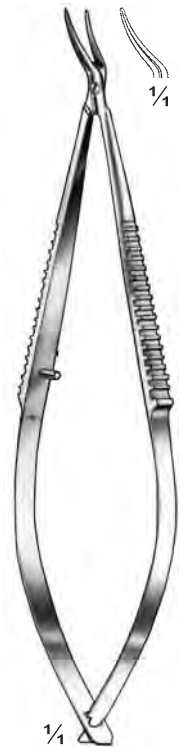

Troutman-Castroviejo
738-16-10
10 cm / 4"



Katzin
739-01-10
Left



Katzin
739-02-10
Right



Katzin
739-03-10
Left



Katzin
739-04-10
Right



Katzin-Barraquer
739-05-10
Left



Katzin-Barraquer
739-06-10
Right

739-01-10 To 739-06-10
10 cm / 4"



Troutman-Barraquer
739-07-10
10 cm / 4"
Left



Troutman-Barraquer
739-08-10
10 cm / 4"
Right

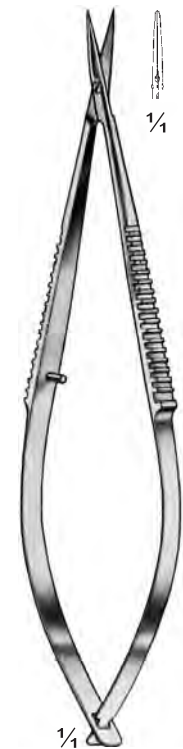

739-09-10
10 cm / 4"



739-10-10
10 cm / 4"

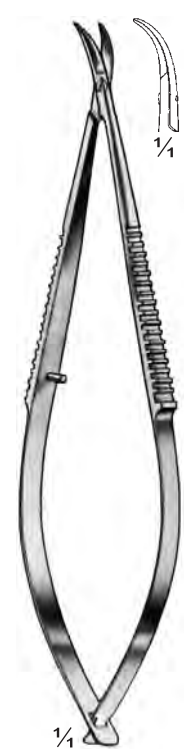

Castroveijo
739-11-10
10 cm / 4"



Castroveijo
739-12-10
10 cm / 4"

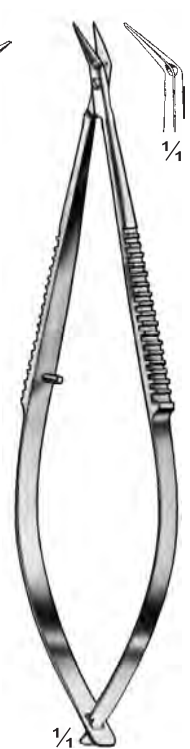

Aebli
739-13-10
10 cm / 4"



Troutman-Castroviejo
740-01-10
10.5 cm / 4 1/8"



Troutman-Castroviejo
740-02-10
10.5 cm / 4 1/8"

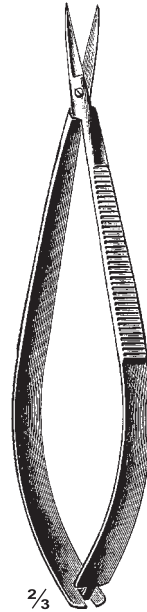

Noyes
740-03-12 To 740-06-12
12 cm / 4 3/4"



740-03-12
740-07-12



740-04-12
740-08-12



740-05-12
740-09-12

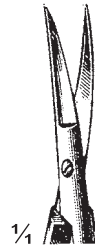

740-06-12
740-10-12

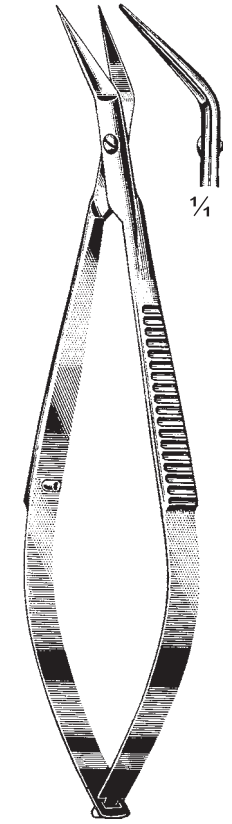

Noyes
740-07-12 To 740-10-12
12 cm / 4 3/4"

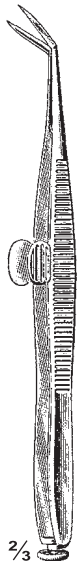

Wecker
740-11-11 To 740-13-11
11 cm / 4 1/4"



740-11-11



740-12-11



740-13-11



740-14-10



740-15-10

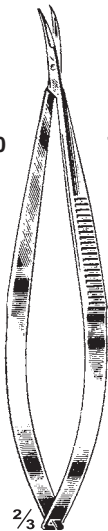

Micro
740-14-10 & 740-15-10
10 cm / 4"

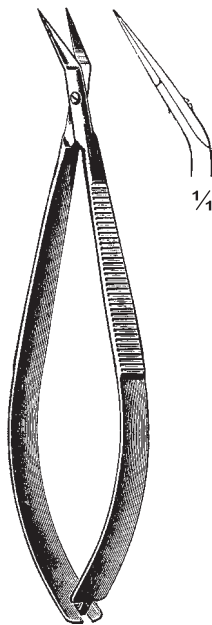

McClure
740-16-10
10.5 cm / 4 1/8"

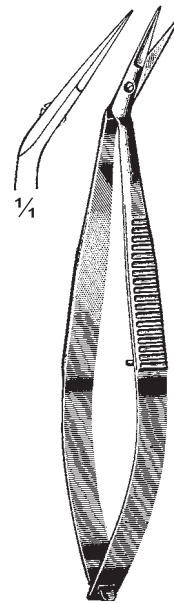

McClure
740-17-10
10 cm / 4"

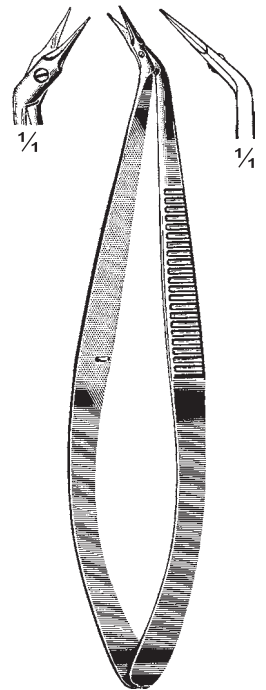

McClure
740-18-09
9.5 cm / 3 3/4"

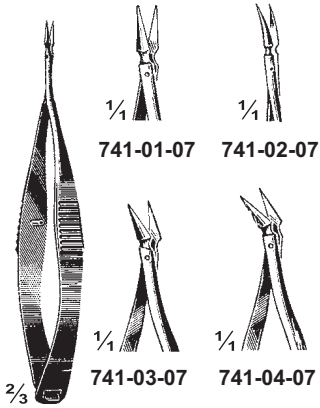

Vannas
741-01-07 To 741-04-07
7.5 cm / 3"

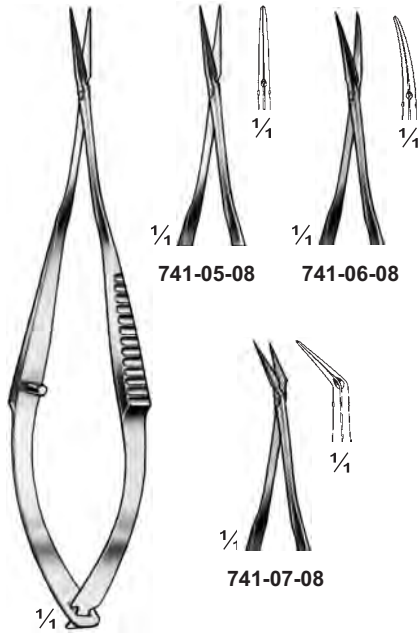

Vannas Mod. Tubingen
741-05-08 To 741-07-08
8.5 cm / 3 1/4"

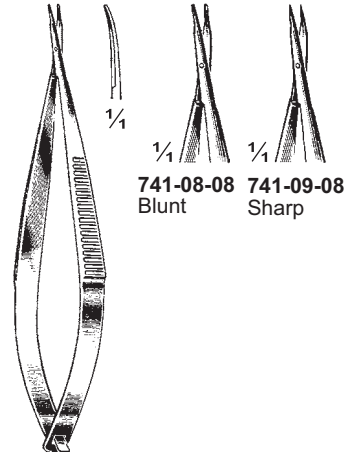

McPherson-Vannas
741-08-08 To 741-09-08
8 cm / 3 1/8"

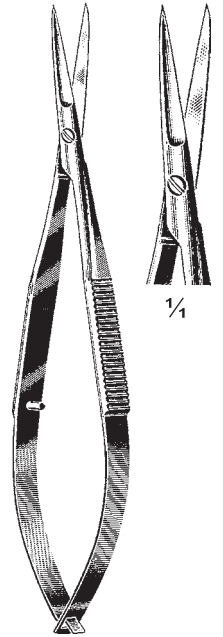

Fine
741-10-11
11.5 cm / 4 1/2"

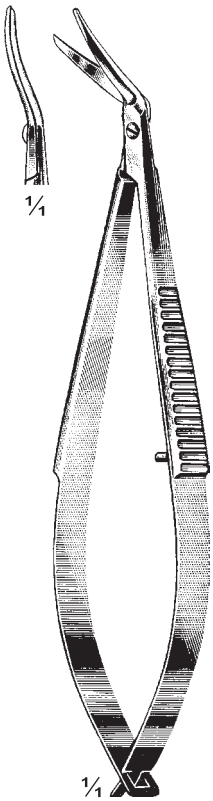

Castroviejo
741-11-11
11 cm / 4 1/4"

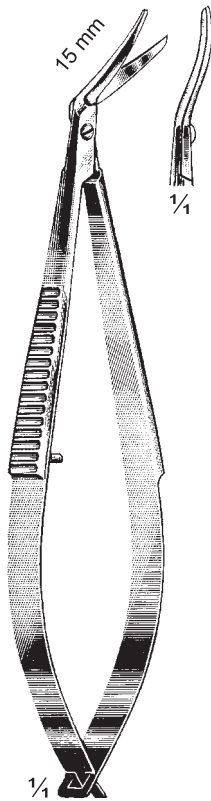

Castroviejo
741-12-11
11 cm / 4 1/4"



McPherson-Westcott
741-13-10
10 cm / 4"



McPherson-
Westcott
741-14-10
10 cm / 4"



Westcott
741-15-11
11 cm / 4 1/4"



Westcott
741-16-11
11 cm / 4 1/4"

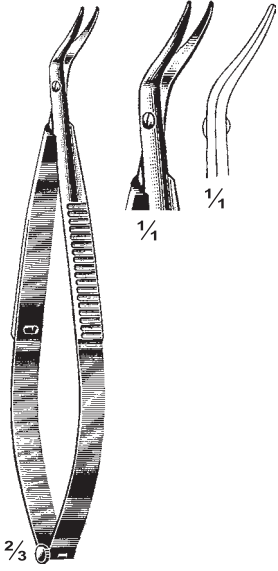

Castroviejo
742-01-11
11 cm / 4 1/4"

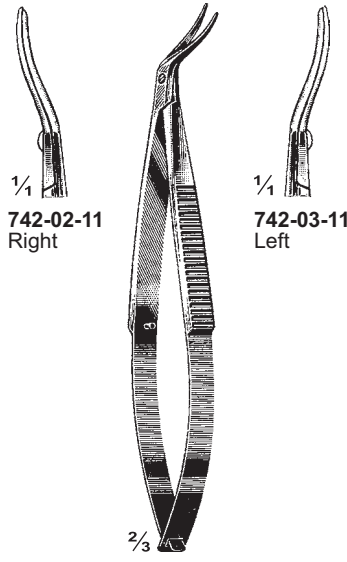

Castroviejo
742-02-11 & 742-03-11
11 cm / 4 1/4"

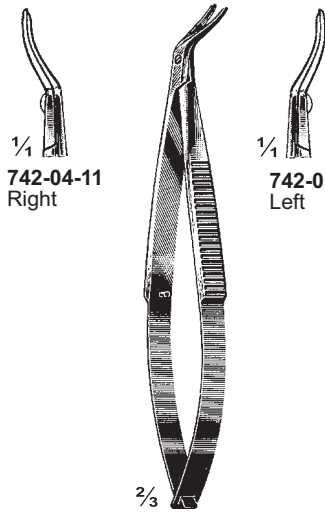

Castroviejo
742-04-11 & 742-05-11
11 cm / 4 1/4"

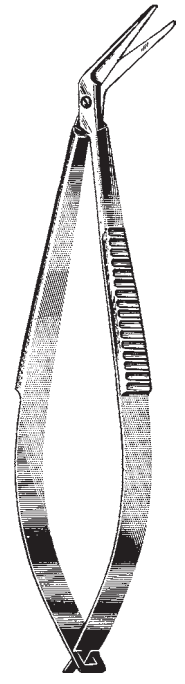

Castroviejo
742-06-09
9 cm / 3 1/2"

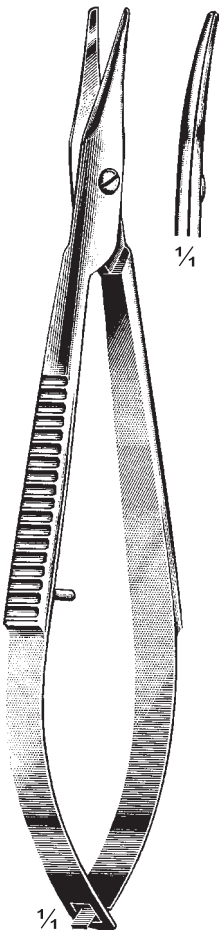

Scheie-Westcott
742-07-12
12 cm / 4 3/4"



742-08-12
12 cm / 4 3/4"

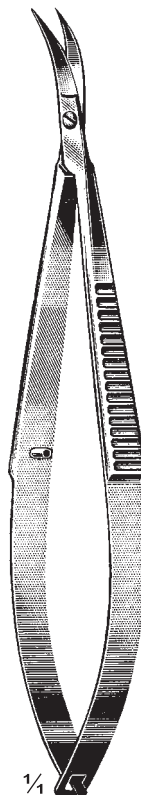

Castroviejo
742-09-10 To 742-11-10
10 cm / 4"

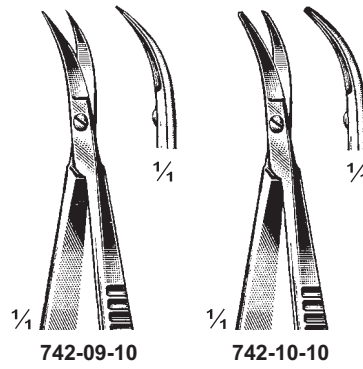

742-09-10

742-10-10

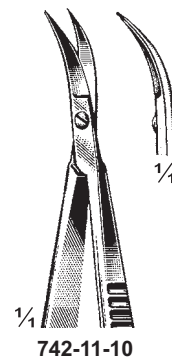

742-11-10

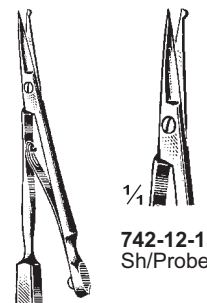

742-12-15
Sh/Probe

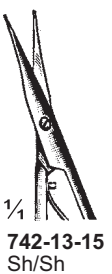

742-13-15
Sh/Sh

742-12-15 & 742-13-15

Noyes
742-12-15 & 742-13-15
15 cm / 6"

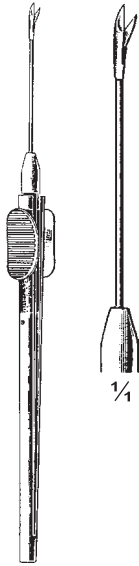

743-01-15
 15 cm / 6"



LaGrange
 743-02-10 To 743-03-10
 10.5 cm / 4 1/8"



743-02-10



743-03-10



743-04-09
 Left

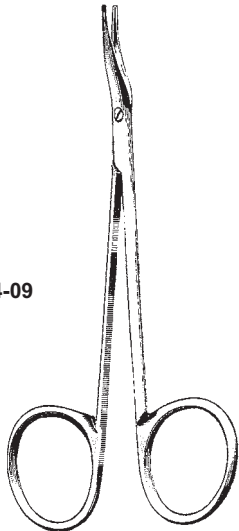

McGuire
 743-04-09 To 743-05-09
 9.5 cm / 3 3/4"



743-05-09
 Right

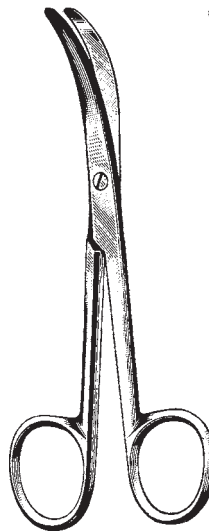

743-06-12 To 743-08-12
 12.5 cm / 5"



743-06-12



743-07-12



743-08-12

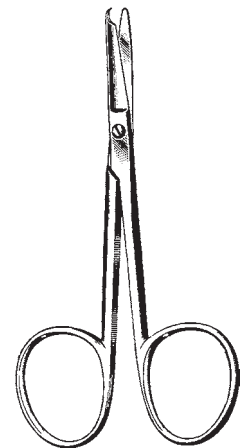

Spencer
 743-09-09
 9 cm / 3 1/2"



Woodruff
 744-01-13
 13 cm / 5 1/8"



Woodruff
 744-02-13
 13 cm / 5 1/8"



Da la Roza
 744-03-12
 12 cm / 4 3/4"



Da la Roza
 744-04-12
 12 cm / 4 3/4"



Hessberg
 744-05-15
 15 cm / 6"



Jacobi
 744-06-14
 14 cm / 5 1/2"



Mod. Heidelberg
 744-07-17
 17.5 cm / 7 7/8"



744-08-18
 18 cm / 7"
 1 X 2 Teeth

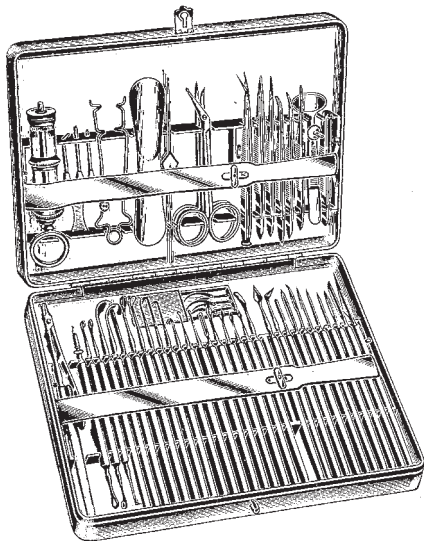

745-01-00

Complete set packed in metal case consisting:

- | | |
|---------------------------------------------|------------------------------------------|
| 1 Graefe cataract knife | 1 Graefe strabismus hook |
| 1 Graefe cataract knife | 1 Graefe iris hook, sharp |
| 1 Graefe cataract knife | 1 Graefe iris hook, blunt |
| 1 Beer cataract knife | 1 Wecker iris spatula |
| 1 Jaeger keratome, str | 1 Jaeger lid plate, metal |
| 1 Jaeger keratome, cur | 1 Record syringe 5 ccm |
| 1 Desmarres corneal knife | 1 Bowman lachrymal probe 00/0 |
| 1 Weber canaliculus knife | 1 Bowman lachrymal probe 1/2 |
| 1 Graefe lachrymal sac scarifier | 1 Bowman lachrymal probe 3/4 |
| 1 Cataract needle, str | 1 Wecker sclerotome |
| 1 Cataract needle, cur | 1 Eye scalpel, bellied |
| 1 Bowman discission needle | 1 Eye scalpel, pointed |
| 1 Desmarres paracentesis needle | 1 Graefe cataract scoop |
| 1 Cystotome | 1 Meyhoefer double ended curette |
| 1 Graefe eye speculum | 1 Weber lens scoop |
| 1 Iris scissors, str, 3 1/2" | 1 Meyer foreign body gouge |
| 1 Iris scissors, cur, 3 1/2" | 1 Schweigger discission needle |
| 1 Iris scissors, angular, 4 1/2" | 1 Cautery needle |
| 1 Tiussue forceps, 4", 1 X 2 teeth, fine | 1 Desmarres lid retractor, 12 mm wide |
| 1 Iris forceps, str, 4" | 1 Desmarres lid retractor, 14 mm wide |
| 1 Iris forceos, semi-cur, 4" | 1 Wecker iris scissors |
| 1 Iris forceos, full-cur, 4" | 1 Graefe strabismus hook |
| 1 Graefe fixation forceps with lock, 4 1/2" | 1 Knapp foreign body hook |
| 1 Beer cilia forceps, 3 1/2" | 1 Castroviejo needle holder |
| 1 Desmarres chalazion forceps | 6 Suture needle in case with sliding lid |
| 1 Jaeger strabismus hook | 6 Eye needles |



745-02-00

Complete set packed in metal case consisting:

- 1 Graefe cataract knife
- 1 Graefe cataract knife
- 1 Graefe cataract knife
- 1 Jaeger keratome, str
- 1 Jaeger keratome, cur
- 1 Weber canaliculus knife
- 1 Bowman discission needle
- 1 Desmarres paracentesis needle
- 1 Foreign body needle
- 1 Cystotome
- 1 Critchett eye speculum
- 1 Iris scissors, cur, 3 1/2"
- 1 Iris scissors, angular, 4 1/2"
- 1 Tiussue forceps, 4", 1 X 2 teeth, fine
- 1 Iris forceps, str, 4"
- 1 Iris forceos, cur, 4"
- 1 Graefe fixation forceps with lock, 4 1/2"
- 1 Beer cilia forceps, 3 1/2"
- 1 Jaeger strabismus hook
- 1 Graefe strabismus hook
- 1 Graefe iris hook, sharp
- 1 Wecker iris spatula
- 1 Bowman lachrymal probe 00/0
- 1 Bowman lachrymal probe 1/2
- 1 Bowman lachrymal probe 3/4



Complete eye sets packed in metal case
for

- 746-01-00 Iridectomy
- 746-02-00 Entropium
- 746-03-00 Enucleation
- 746-04-00 Evisceration
- 746-05-00 Cataract
- 746-06-00 Chalazion
- 746-07-00 Keratoplasty
- 746-08-00 Pterygium
- 746-09-00 Strabismus
- 746-10-00 Lachrymna Sac

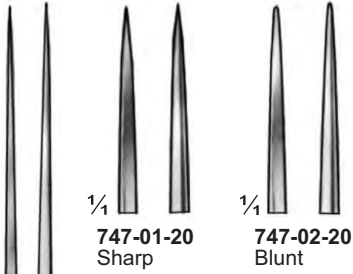

1/4
747-01-20
 Sharp

1/4
747-02-20
 Blunt



1/2

747-01-20 & 747-02-20
 20 cm / 8"



747-03-20 To 747-06-20
 20 cm / 8"



1/4
747-03-20



1/4
747-04-20



1/4
747-05-20



1/4
747-06-20



1/2

747-07-20 & 747-08-20
 20 cm / 8"



1/4
747-07-20



1/4
747-08-20



1/2

Yasargil
747-09-18 To 747-17-124
 18.5 cm / 7 1/4"



1/4
747-09-18



1/4
747-10-18



1/4
747-11-18



1/4
747-12-18



1/4
747-13-18



1/4
747-14-18



1/4
747-15-18



1/4
747-16-124
 124°



1/4
747-17-124
 124°



1/2

Yasargil
747-18-16 & 747-19-16
 16 cm / 6 1/4"



1/4
747-18-16



1/4
747-19-16

Mikro-Nadelhalter, Neurochirurgie
Micro Neuro Scissors, Micro Needle Holder
Micro Porte-aiguilles, Neurochirurgie

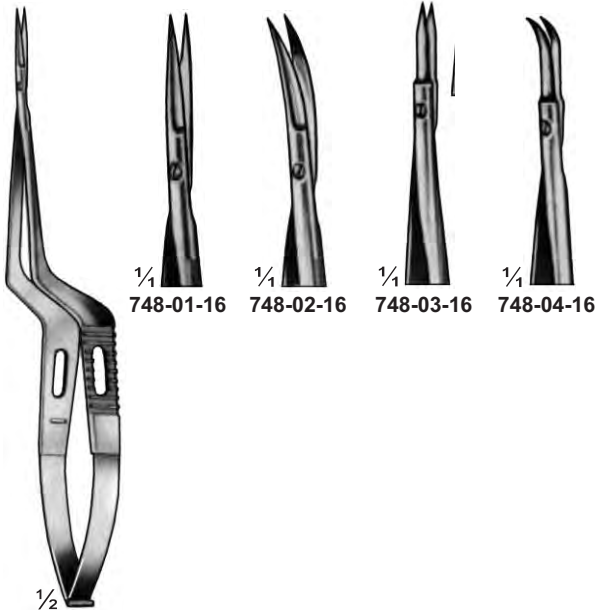

Yasargil
748-01-16 To 748-04-16
 16 cm / 6¼"

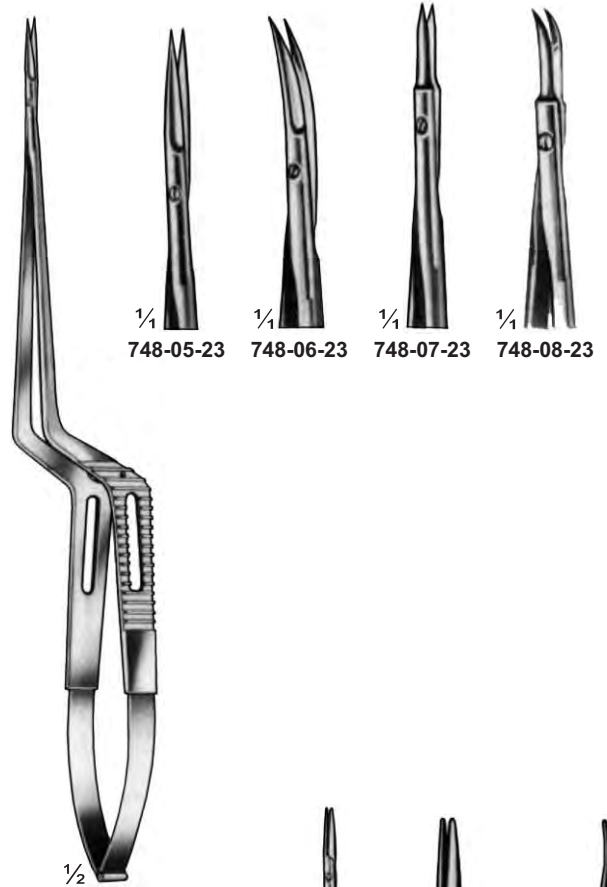

Yasargil
748-05-23 To 748-08-23
 23 cm / 9"

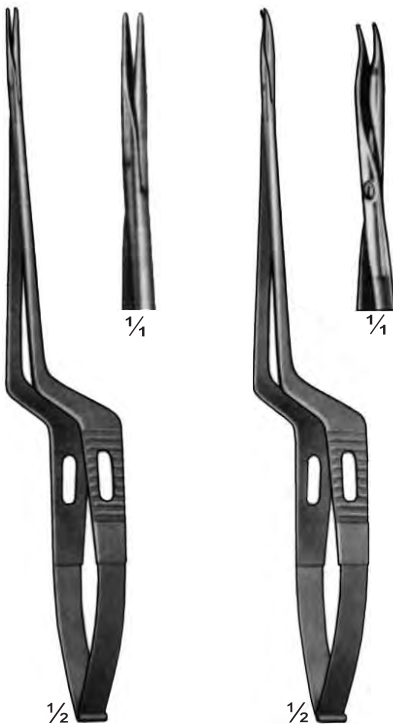

Yasargil
748-09-18
 18.5 cm / 7¼"

Yasargil
748-10-18
 18.5 cm / 7¼"

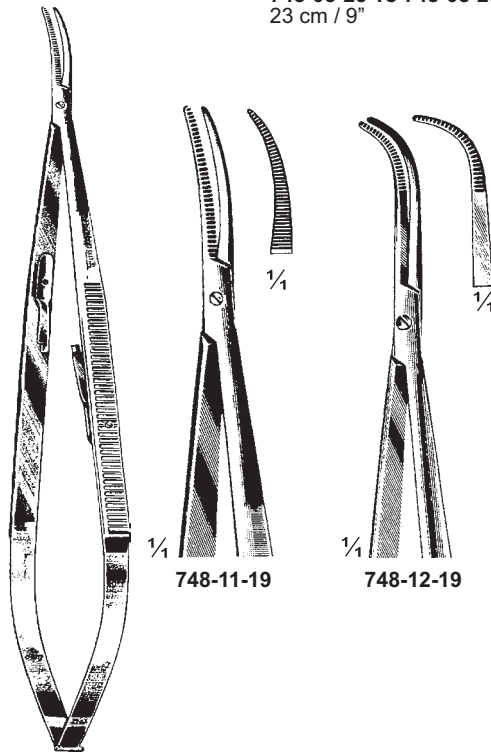

748-11-19 & 748-12-19
 19.5 cm / 7¾"

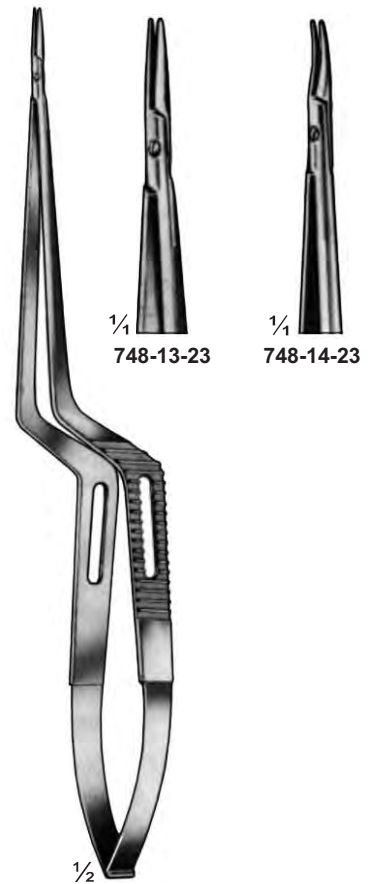

748-13-23 & 748-14-23
 23 cm / 9"

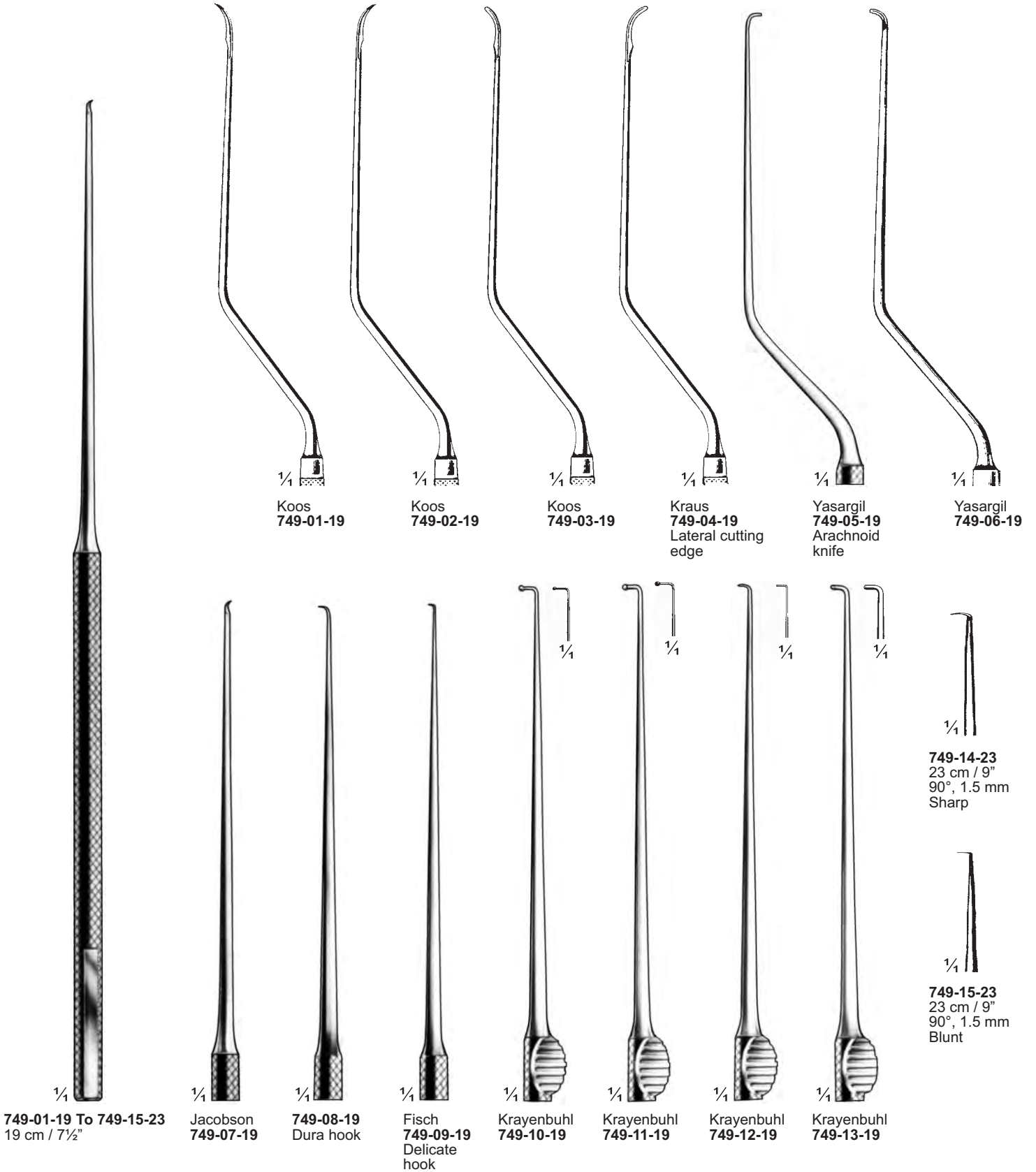



750-01-19 To 750-17-19
19 cm / 7½"

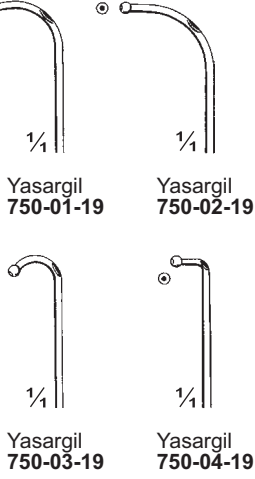

Yasargil 750-01-19
Yasargil 750-02-19
Yasargil 750-03-19
Yasargil 750-04-19

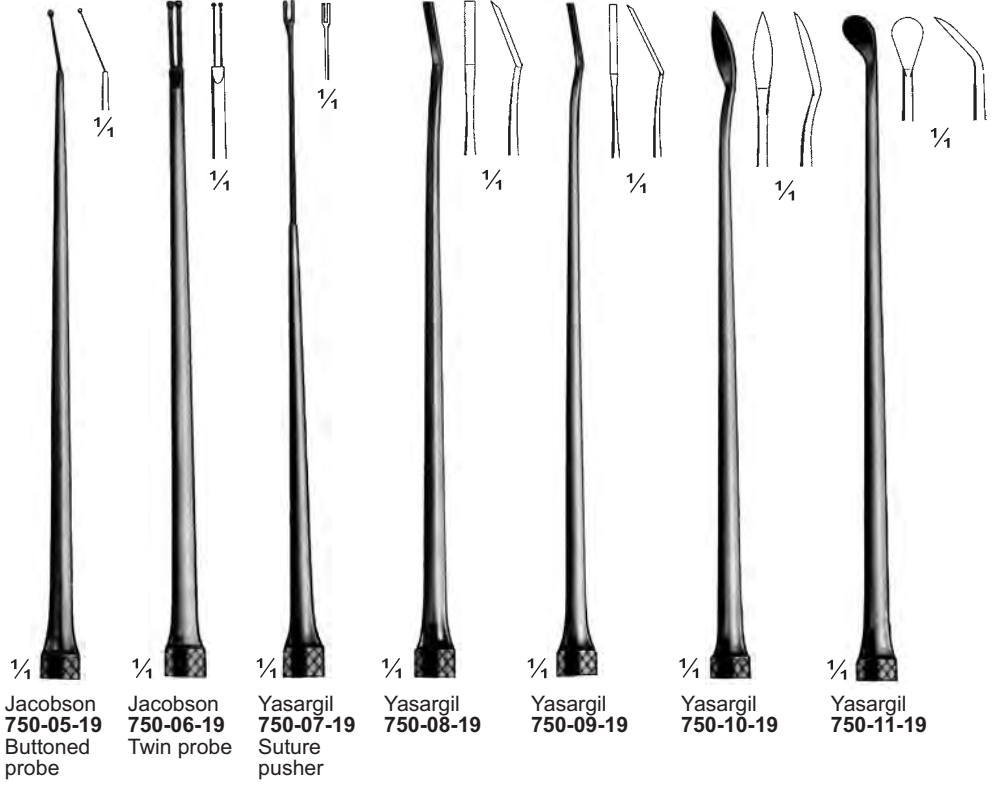

Jacobson 750-05-19 Buttoned probe
Jacobson 750-06-19 Twin probe
Yasargil 750-07-19 Suture pusher
Yasargil 750-08-19
Yasargil 750-09-19
Yasargil 750-10-19
Yasargil 750-11-19

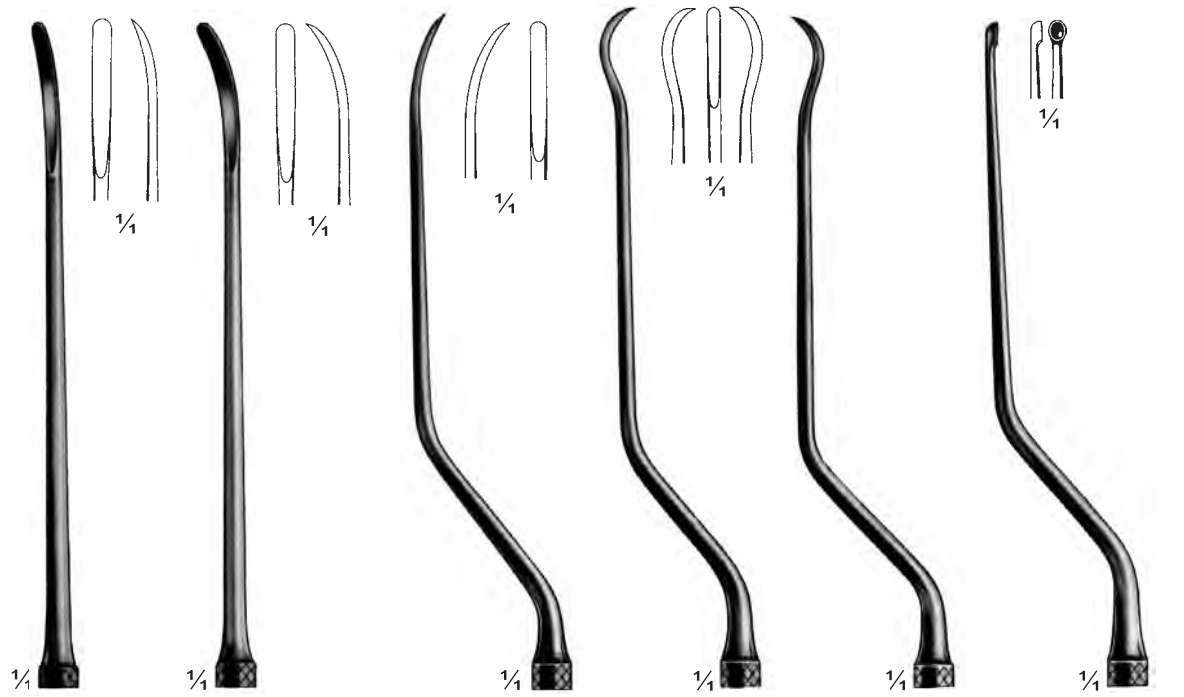

Yasargil 750-12-19
Yasargil 750-13-19
Yasargil 750-14-19
Yasargil 750-15-19
Yasargil 750-16-19
Yasargil 750-17-19 Scoop

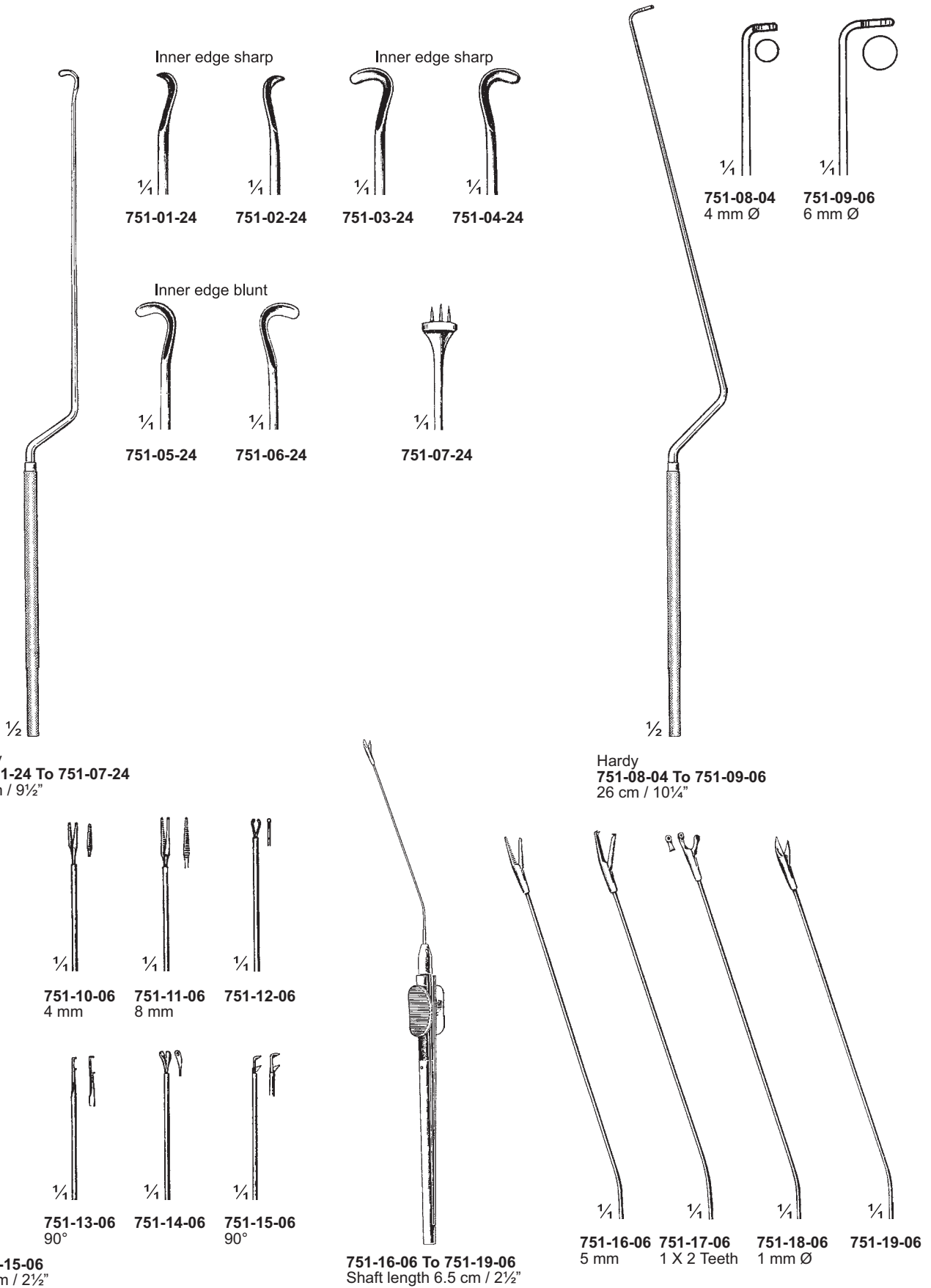



752-01-14
Str



752-02-14
Cur upward



752-03-14
Cur to right



752-04-14
Cur to left



752-01-14 To 752-04-14
Shaft length 14 cm / 5½"



752-05-05 0.5 mm Ø
752-06-01 1.0 mm Ø
Str



752-07-05 0.5 mm Ø
752-08-01 1.0 mm Ø
Cur upward



752-05-05 To 752-11-01
Shaft length 14 cm / 5½"



752-09-05
0.5 mm Ø
Cur to right



752-10-05 0.5 mm Ø
752-11-01 1.0 mm Ø
Cur to left



752-12-02
2 mm Ø
Str



752-13-03
3 mm Ø
Str

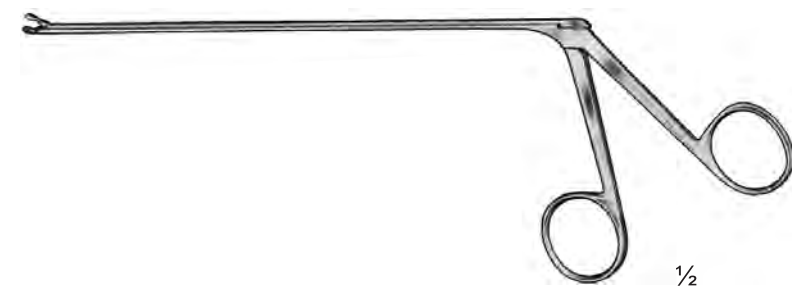

752-12-02 To 752-13-03
Shaft length 14 cm / 5½"



Yasargil
752-14-18
Str



Nicola
752-15-02
2 mm Ø
Str



Nicola
752-16-18
Str

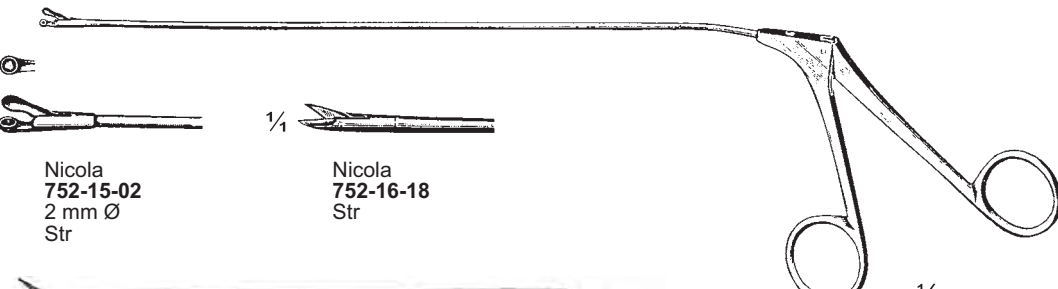

752-14-18 To 752-16-18
Shaft length 18 cm / 7"



752-17-14
Str



752-18-14
Cur to right



752-19-14
Cur to left

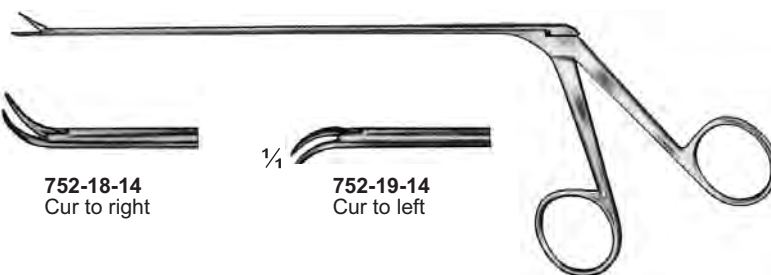

752-17-14 To 752-19-14
Shaft length 14 cm / 5½"



753-01-18 18 cm / 7"
753-02-22 22 cm / 8 3/4"

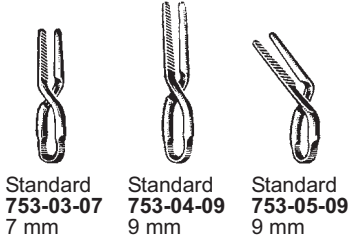

Standard 753-03-07 7 mm
Standard 753-04-09 9 mm
Standard 753-05-09 9 mm

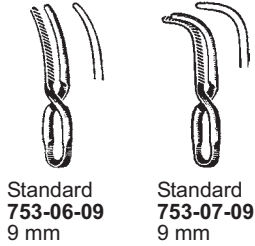

Standard 753-06-09 9 mm
Standard 753-07-09 9 mm



753-08-18 18 cm / 7"
753-09-22 22 cm / 8 3/4"

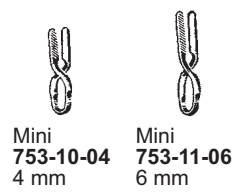

Mini 753-10-04 4 mm
Mini 753-11-06 6 mm

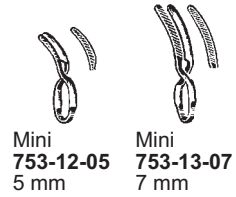

Mini 753-12-05 5 mm
Mini 753-13-07 7 mm

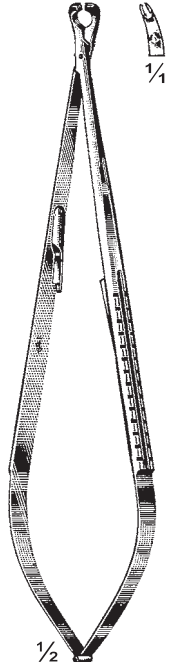

753-14-18 18 cm / 7"

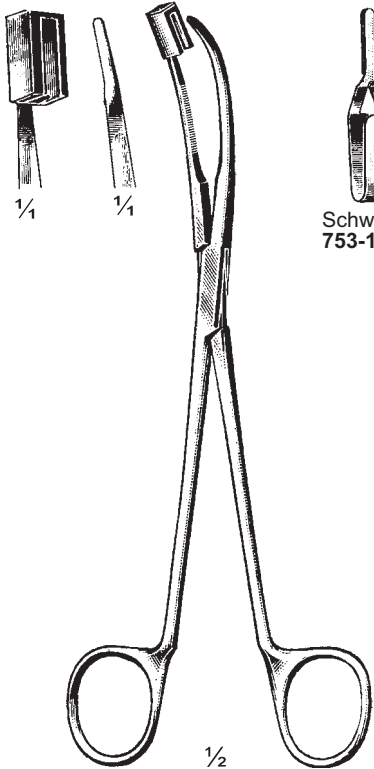

Schwartz 753-15-20 20 cm / 8"

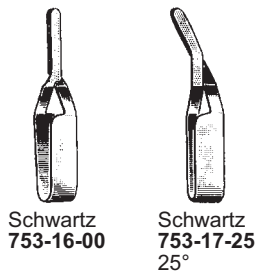

Schwartz 753-16-00
Schwartz 753-17-25 25°



Schwartz 753-18-45 45°

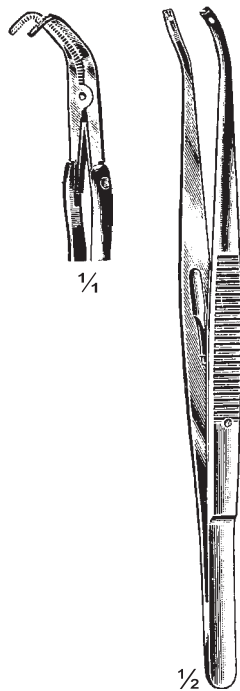

753-19-18 18 cm / 7"



Yasargil 753-20-25 25 mm



Yasargil 753-21-75 75 mm



Jacobson-Potts 753-22-15 15 cm / 6"

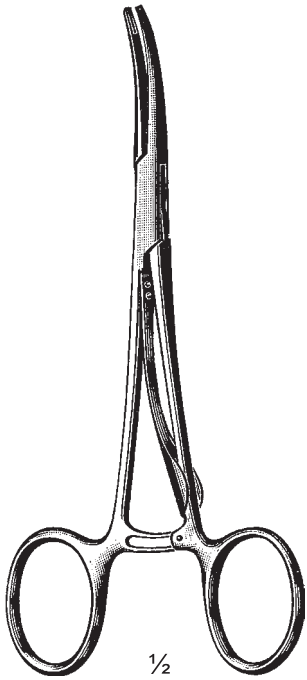

$\frac{1}{2}$
McKenzie
754-01-15 15 cm / 6"
754-02-18 18 cm / 7"

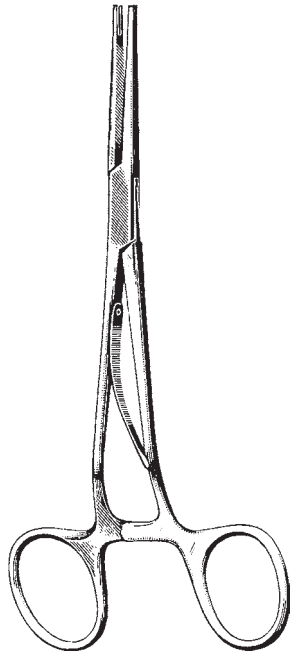

McKenzie
754-03-15 15 cm / 6"
754-04-18 18 cm / 7"

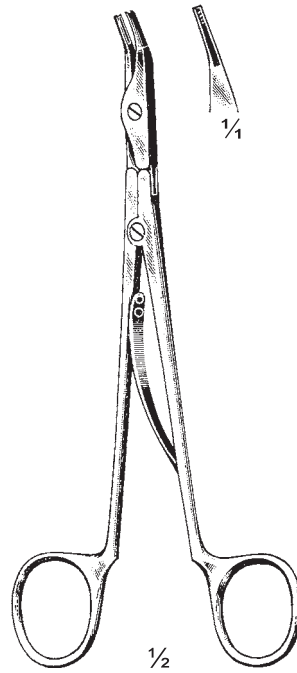

McKenzie Modif.
754-05-18 18 cm / 7"



Raney
754-06-16 16 cm / 6 $\frac{1}{4}$ "



$\frac{1}{4}$



$\frac{1}{2}$
Olivecrona-Toennis
(Scoville)
754-07-14
Shaft length 14 cm / 5 $\frac{1}{2}$ "

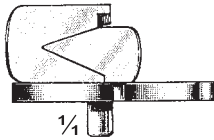

$\frac{1}{4}$

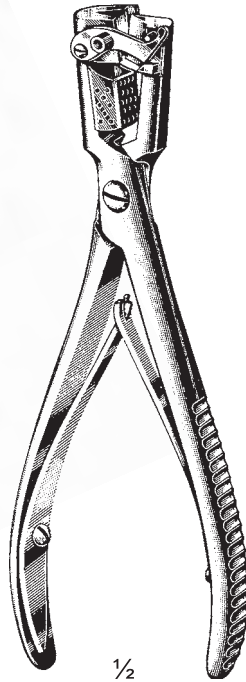

Mc-Kenzie
754-08-18 18 cm / 7"

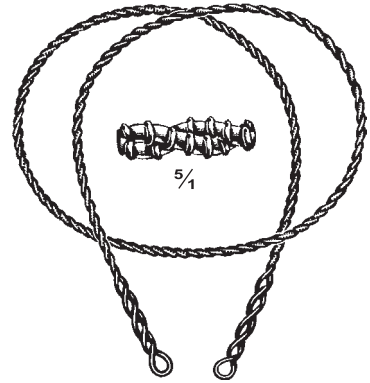

Gigli (Olivecrona)
754-09-30 30 cm / 12"
754-10-40 40 cm / 16"
754-11-50 50 cm / 20"
754-12-60 60 cm / 24"
754-13-70 70 cm / 28"

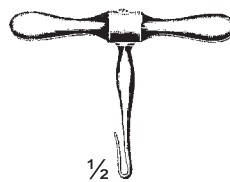

Gigli
754-14-06 6 cm / 2 $\frac{1}{4}$ "

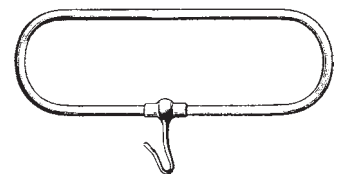

Gigli
754-15-00



Martel
755-01-33
33 cm / 13"

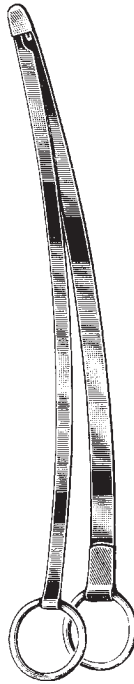

Adson
755-02-19
19 cm / 7½"



Lebsche
755-03-25
25 cm / 10"



Dahlgren
755-04-20
20 cm / 8"
With one blade



De Vilbiss
755-05-21
21 cm / 8¼"
With two blades

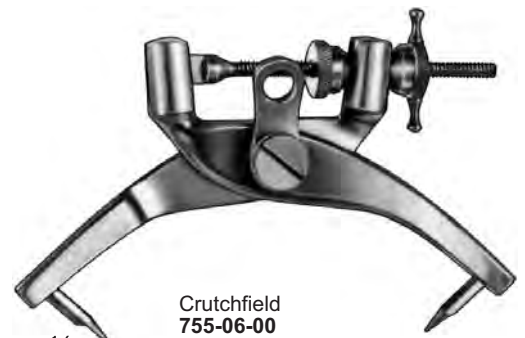

Crutchfield
755-06-00
Cervical traction tongs
Small size



**Crutchfield
756-01-00**
Cervical traction tongs
Medium size



756-04-00
Cervical traction tongs for extension
of the neck vertebrae
Large size

Drill points for traction tongs



756-02-03
3.5 mm Ø



756-03-05
5 mm Ø

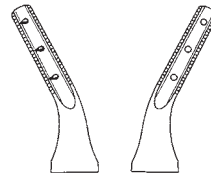

$\frac{1}{4}$

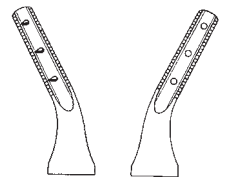

$\frac{1}{4}$



$\frac{1}{4}$

**Yasargil
756-05-31**
31 cm / 12 $\frac{1}{4}$ "



$\frac{1}{4}$

**Yasargil
756-06-41**
41 cm / 16 $\frac{1}{4}$ "

Duradisektoren Dura Dissectors Dissecteurs à dure-mère



1/2
Frazier
757-01-15
15 cm / 6"



1/2
Frazier
757-02-15
15 cm / 6"



1/2
Frazier
757-03-15
15 cm / 6"

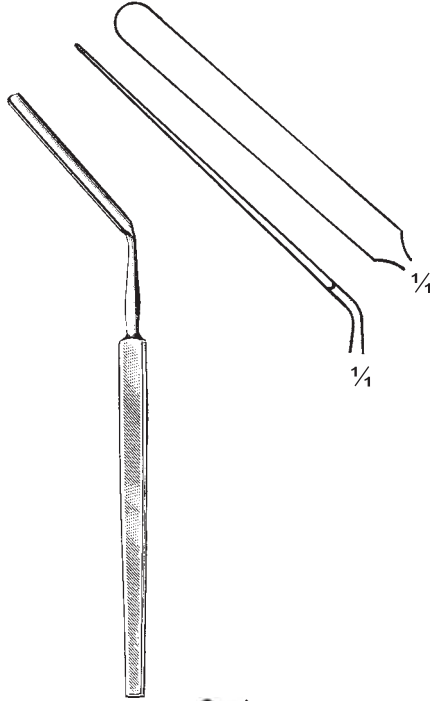

Horsley
757-04-20
20 cm / 8"

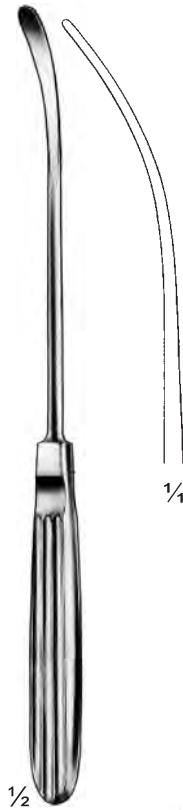

1/2
Sachs
757-05-21
21 cm / 8 1/4"



1/4
1/4
Penfield
757-06-21
21.5 cm / 8 1/2"



Sachs
757-07-21
21 cm / 8 1/4"



1/4



1/4



1/4



1/4



Sachs
757-08-20
20 cm / 8"



1/2
Davis
757-09-19
19 cm / 7 1/2"

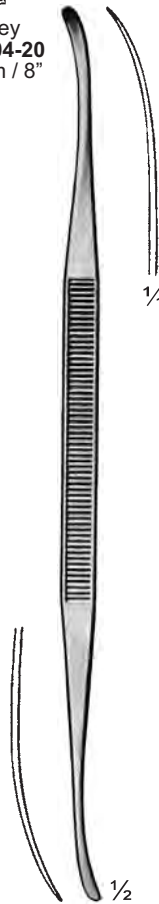

Toennis
757-10-05 & 757-11-06
24 cm / 9 1/2"

3.5 mm



1/4

757-10-05
5 mm

4.5 mm



1/4

757-11-06
6 mm

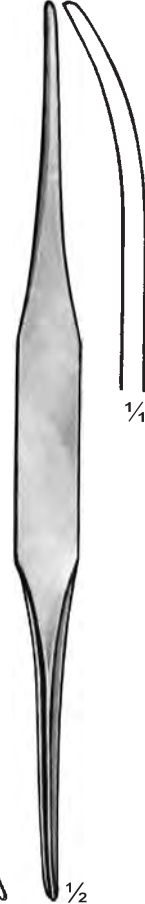

Toennis
757-12-24
24 cm / 9 1/2"

**Duradisektoren
Dura Dissectors
Dissecteurs à dure-mère**



Penfield
758-01-20
20 cm / 8"



Penfield
758-02-20
20 cm / 8"

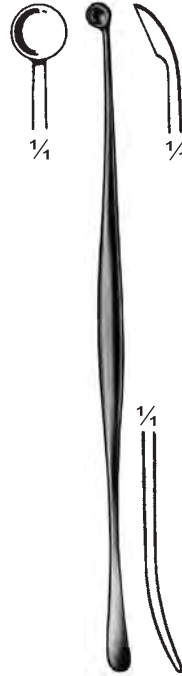

Penfield
758-03-18
18 cm / 7"



Milligan
758-04-21
21 cm / 8¼"



Olivecrona
758-05-18 18 cm / 7"
758-06-24 24 cm / 9½"

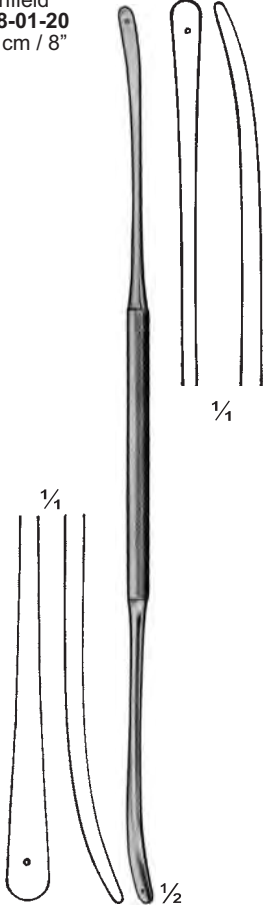

Olivecrona
758-07-18 18 cm / 7"
758-08-24 24 cm / 9½"



Davis
758-09-24
24.5 cm / 9¾"



758-10-22
22 cm / 8¾"



Penfield
758-11-29
29 cm / 11½"



Toennis
759-01-15
15 cm / 6"

Lahey
759-02-13
13 cm / 5 1/8"

Cushing
759-03-14
14 cm / 5 1/2"

Frazier
759-04-13 To 759-07-18

Adson
759-08-20
20 cm / 8"

Adson
759-09-20
20 cm / 8"

Graham
759-10-16
16.5 cm / 6 1/2"

Sachs
759-11-18
18.5 cm / 7 1/4"

Cushing
759-12-19 19 cm / 7 1/2"
759-13-28 28 cm / 11"

Cushing
759-14-19 19 cm / 7 1/2"
759-15-28 28 cm / 11"

Dandy
759-16-21
21 cm / 8 1/4"

Dandy
759-17-21
21 cm / 8 1/4"

Dandy
759-18-21
21 cm / 8 1/4"

Smithwick
759-19-17 To 759-20-21

759-19-17
17 cm / 6 3/4"

759-20-21
21 cm / 8 1/4"

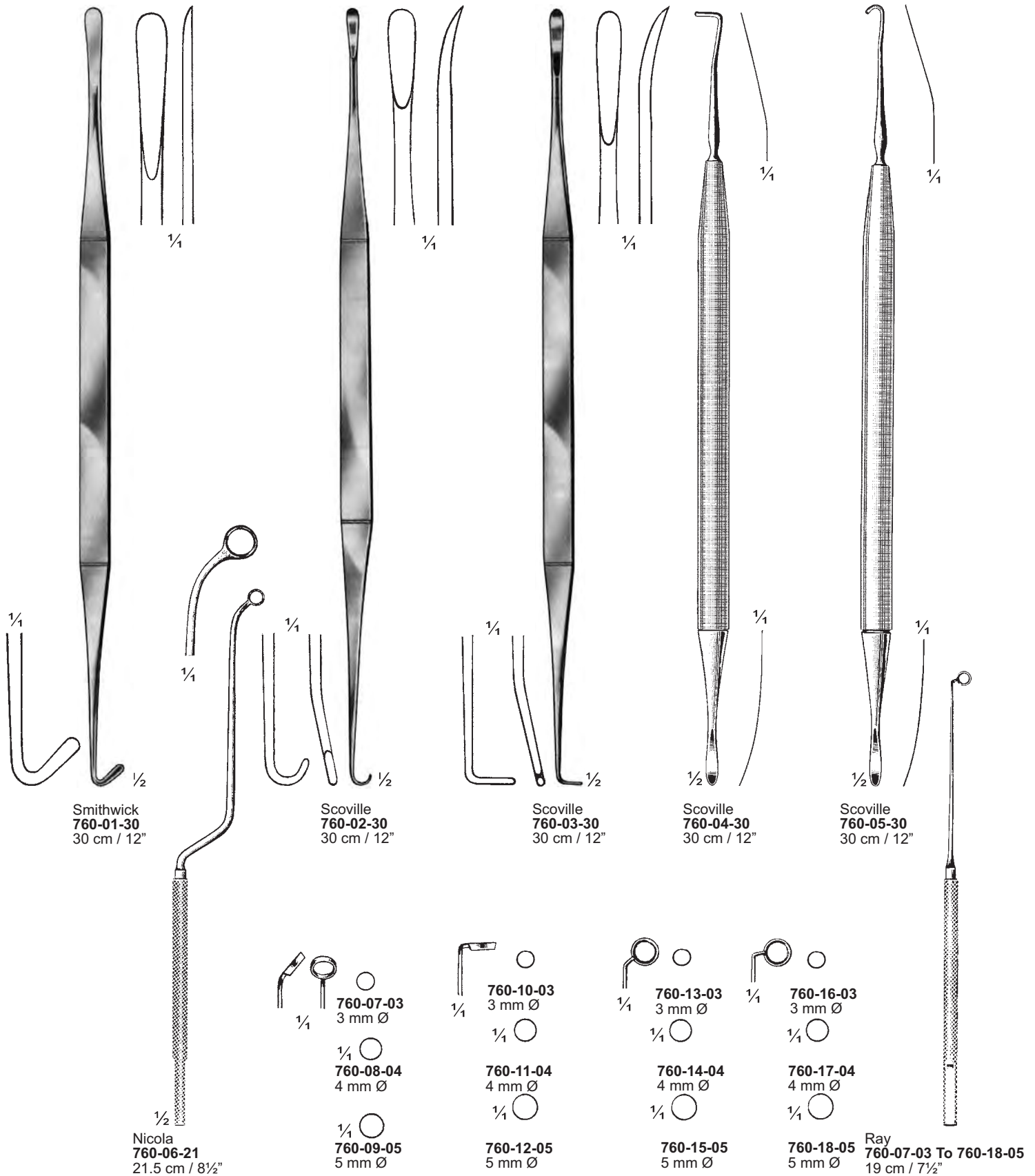



761-01-25



761-02-25



761-03-25

Scoville
761-01-25 To 761-03-25
25 cm / 10"



761-04-04
761-07-04
4 mm Ø



761-05-07
761-08-07
7 mm Ø



761-06-09
761-09-09
9 mm Ø

Cone
761-04-04 To 761-06-09
23 cm / 9"

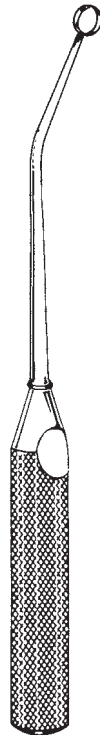

Cone
761-07-04 To 761-09-09
23 cm / 9"



Cushing
761-10-05 To 761-14-12
23.5 cm / 9 1/4"



761-10-05
5 mm



761-11-07
7 mm



761-12-09
9 mm



761-13-10
10 mm

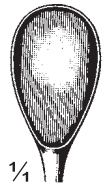

761-14-12
12 mm



Cushing
761-15-19
19 cm / 7 1/2"



Cushing
761-16-19
19 cm / 7 1/2"



Hoehn
761-17-22
22 cm / 8 3/4"



Dandy
761-18-20
20 cm / 8"

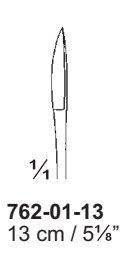

762-01-13
13 cm / 5 1/8"



762-02-19
19 cm / 7 1/2"

Toennis
762-01-13 & 762-02-19

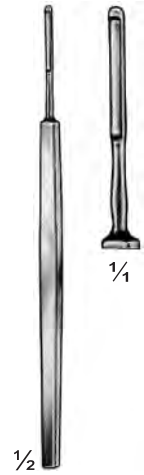

762-03-12
12.5 cm / 5"



Bucy
762-04-16 To 762-07-16
16.5 cm / 6 1/2"



762-04-16

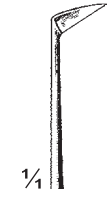

762-05-16



762-06-16



762-07-16

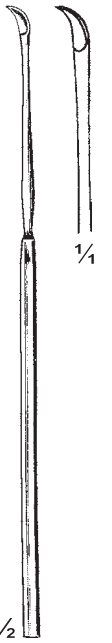

Frazier
762-08-17
17 cm / 6 3/4"

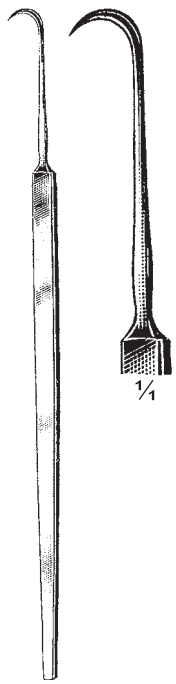

Olivecrona
762-09-17
17 cm / 6 3/4"



Olivecrona
762-10-23
23 cm / 9"



1/4



Halle
762-11-20
20 cm / 8"



1/4



Woodson
762-12-18
18 cm / 7"



1/4



Woodson
762-13-18
18 cm / 7"

1/2

Nervwurzelhaken, Komedoneninstrumente Nerve Root Retractors, Comedone Extractors Tire-Comédons, Retracteurs pour racines nerveuses

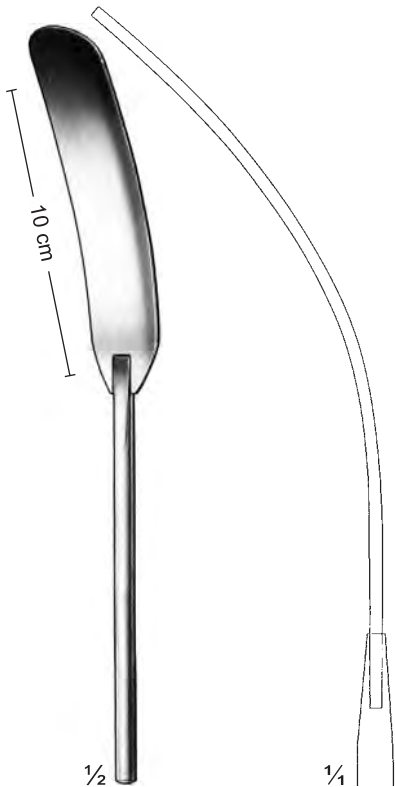

Heifetz
763-01-08 To 763-05-20
20 cm / 8"
Malleable

- 763-01-08 8 mm
- 763-02-11 11 mm
- 763-03-14 14 mm
- 763-04-17 17 mm
- 763-05-20 20 mm

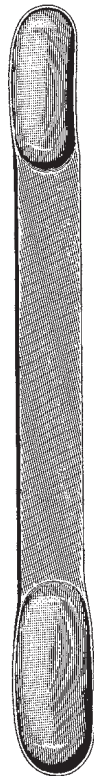

Cushing
763-06-08 To 763-0816

763-06-08
17 cm / 6³/₄"
8 X 10 mm

763-07-13
20 cm / 8"
13 X 15 mm

763-08-16
28 cm / 11"
16 X 18 mm

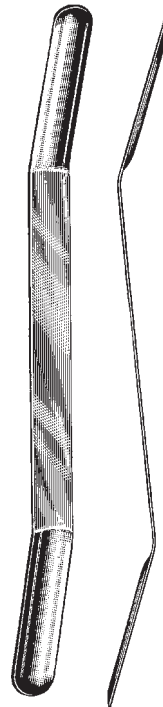

Olivecrona
Concave
763-09-07
763-10-11
763-11-15
763-12-18
18 cm / 7"

Width of spatulas	
Upper end	Lower end
7 mm	9 mm
11 mm	13 mm
15 mm	18 mm
18 mm	22 mm

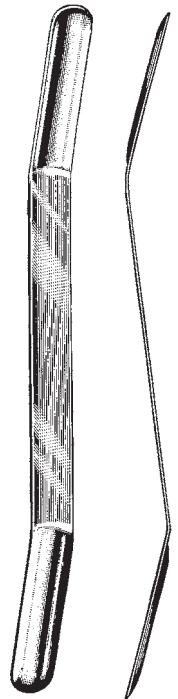

Olivecrona
Convex
763-13-07
763-14-11
763-15-15
763-16-18
18 cm / 7"

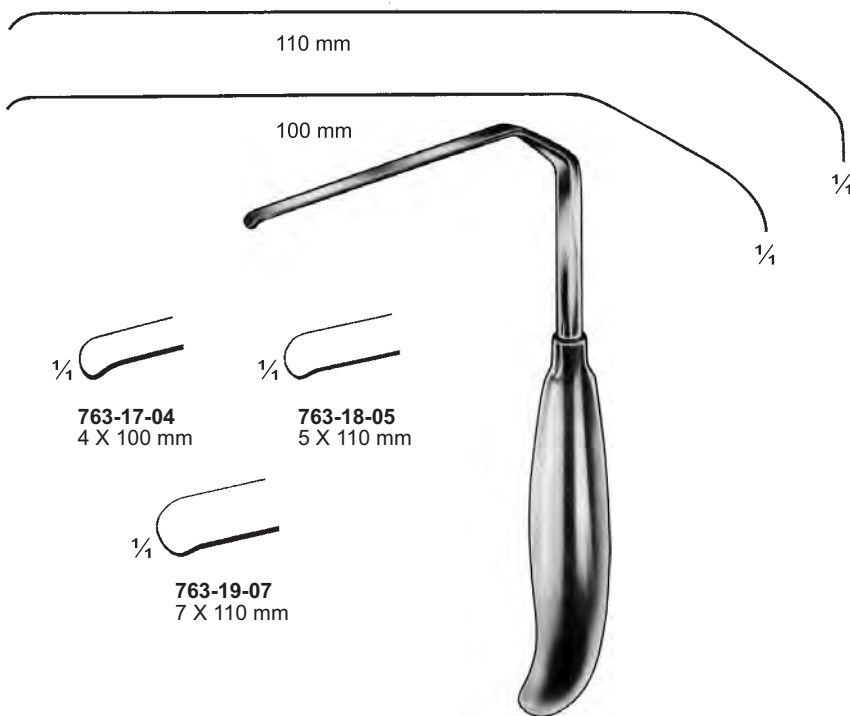

763-17-04 To 763-19-07

763-17-04
4 X 100 mm

763-18-05
5 X 110 mm

763-19-07
7 X 110 mm

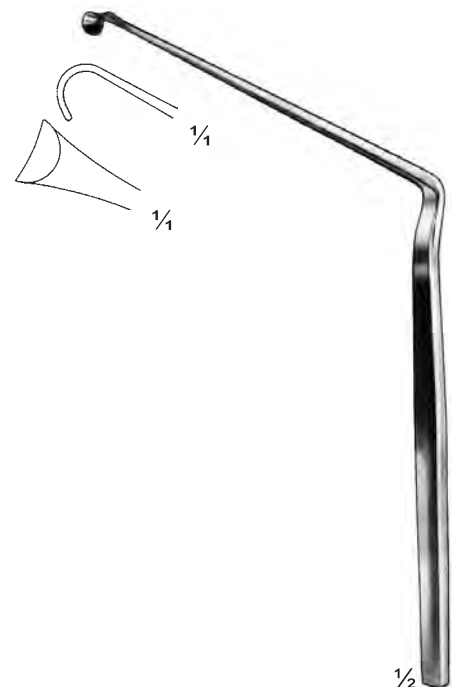

763-20-21
21 cm / 8¹/₄"

Nervwurzelhaken, Komedoneninstrumente
Nerve Root Retractors, Comedone Extractors
Tire-Comédons, Retracteurs pour racines nerveuses



Scoville
764-01-23
23 cm / 9"



1/2
Scoville
764-02-24
24 cm / 9 1/2"

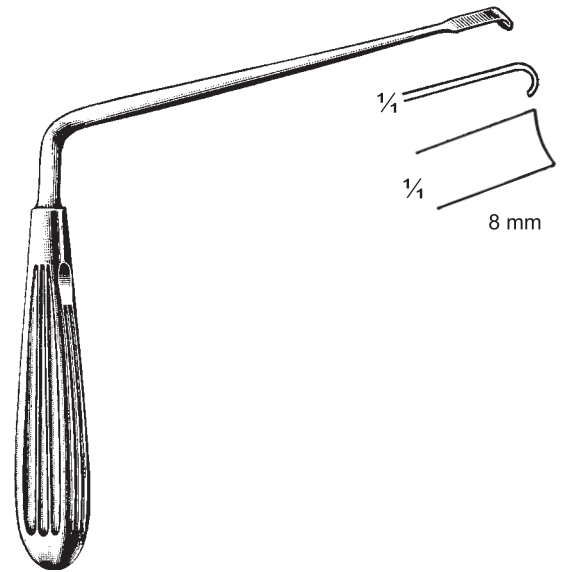

Scoville
764-03-23
23 cm / 9"

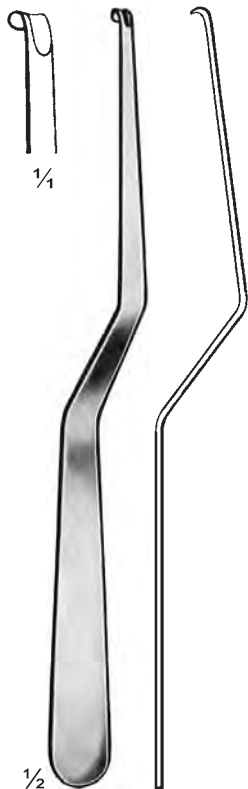

Love
764-04-21
21 cm / 8 1/4"



Oldberg
764-05-19 To 764-08-19
21 cm / 8 1/4"



764-05-19
19 mm



764-06-13
13 mm



764-07-15
15 mm



764-08-19
19 mm

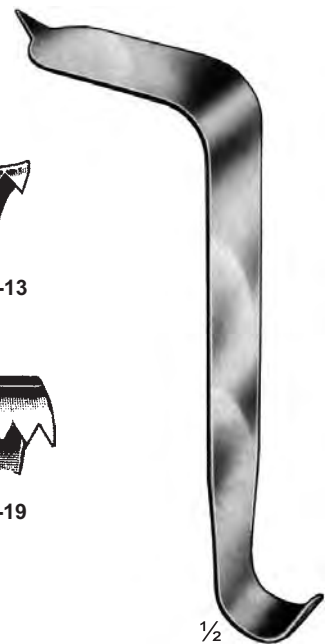

Taylor
764-09-30 30 X 70 mm
764-10-30 30 X 100 mm
17 cm / 6 3/4"

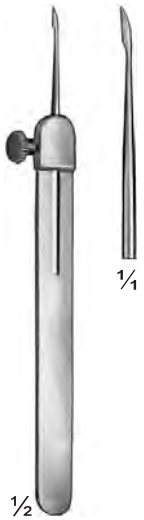

Moncorps
765-01-13
 13 cm / 5 1/8"



Vidal
765-02-14
 14 cm / 5 1/2"

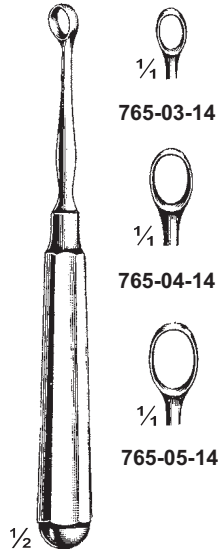

Piffard
765-03-14 To 765-05-14
 14.5 cm / 5 3/4"



Fox
765-06-14 To 765-09-14
 14.5 cm / 5 3/4"



Wolff
765-10-14 To 765-15-14
 14.5 cm / 5 3/4"

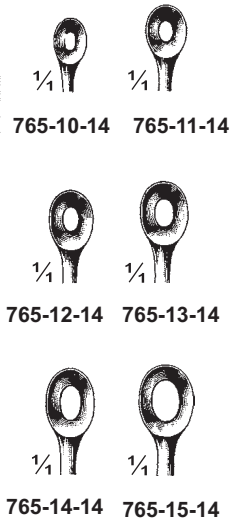

Kilner
765-16-15
 15 cm / 6"

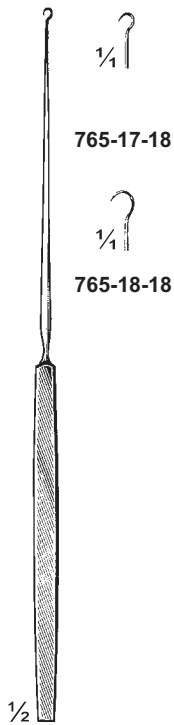

Gillies
765-17-18 & 765-18-18
 18 cm / 7"

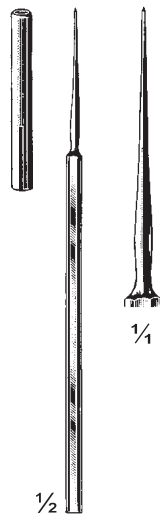

765-19-13
 13 cm / 5 1/8"

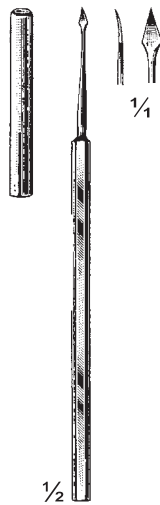

765-20-13
 13 cm / 5 1/8"

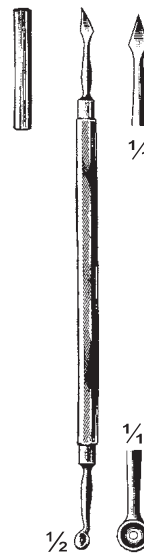

Katsch
765-21-14
 14 cm / 5 1/2"

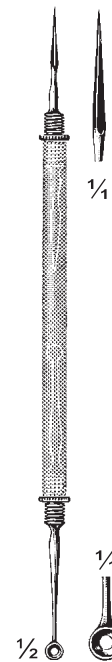

Unna-Vidal
765-22-11
 11.5 cm / 4 1/2"

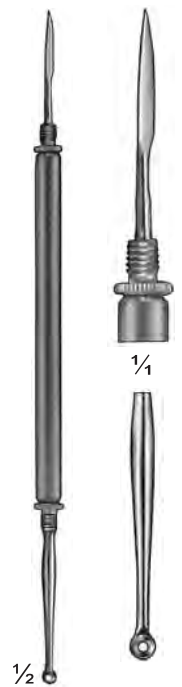

Hebra
765-23-18
 18 cm / 7"

Face-Lift-Haken, Komedoneninstrumente Face-lift Hooks, Comedone Extractors Face-lift Crochet, Tire-comédons

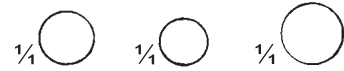
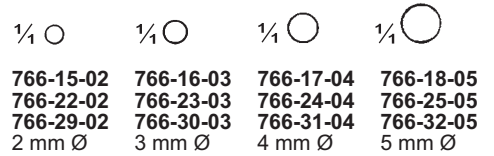
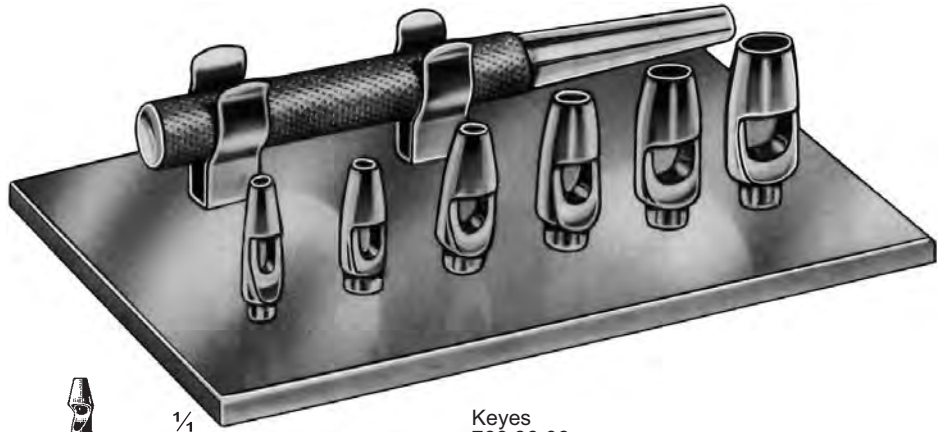
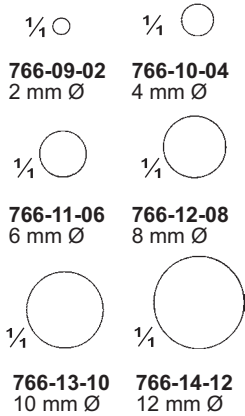
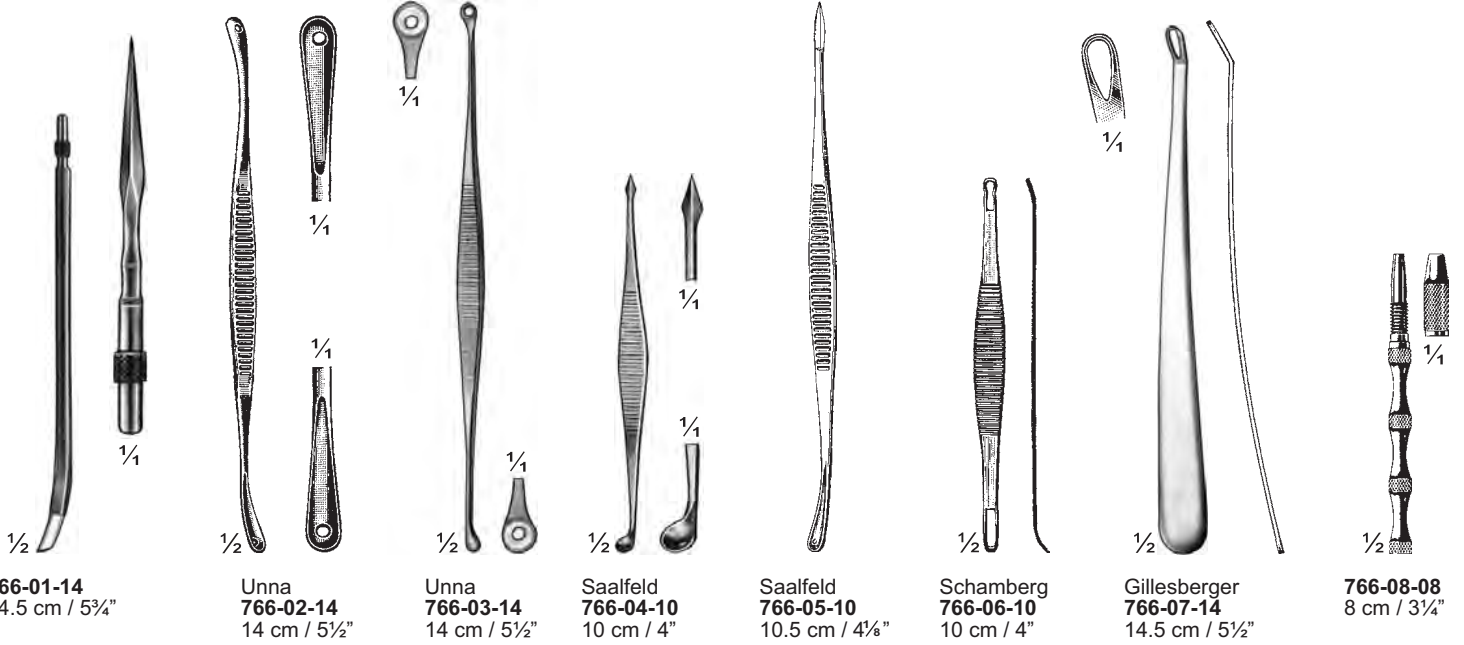

766-09-02 To 766-14-12
6 cm / 2"

Keys 766-15-02 To 766-21-08
10 cm / 4"

Keys 766-22-02 To 766-28-08
11.5 cm / 5½"

Keys 766-29-02 To 766-35-08
9 cm / 3½"

766-19-06 6 mm Ø
766-20-07 7 mm Ø
766-21-08 8 mm Ø
766-26-06
766-27-07
766-28-08
766-33-06
766-34-07
766-35-08

Darm-und Gewebefasszangen Intestinal and Tissue Grasping Forceps Pinces pour saisir intestins et tissus



Allis-Adair
767-01-15
15 cm / 6"
10 X 11 Teeth

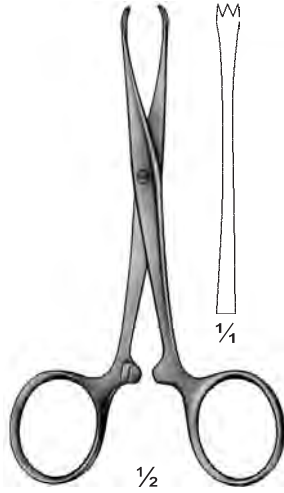

Chaput
767-02-12
12.5 cm / 5"
2 X 3 Teeth

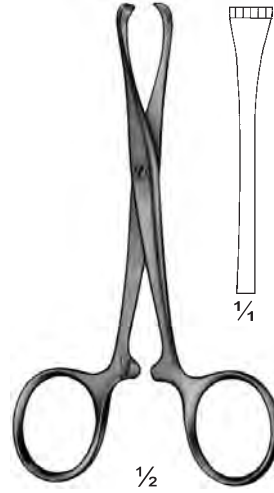

Tuffier
767-03-12
12.5 cm / 5"
5 X 6 Teeth

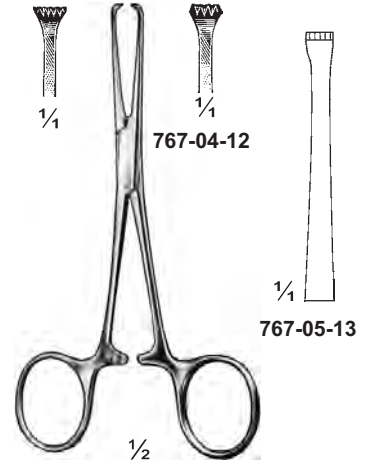

Allis-Baby
767-04-12 12 cm / 4 3/4"
767-05-13 13 cm / 5 1/8"
4 X 5 Teeth

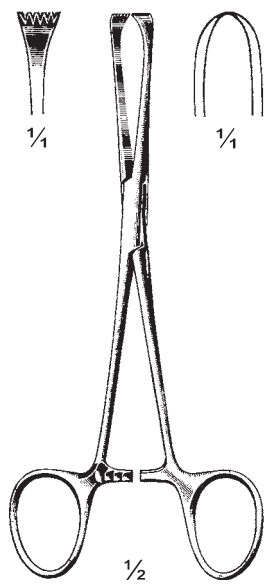

Boys-Allis
767-06-15
15 cm / 6"
5 X 6 Teeth

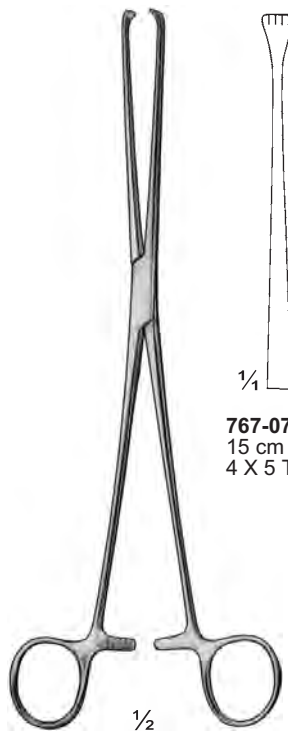

Allis
767-07-15 To 767-10-25



767-07-15
15 cm / 6"
4 X 5 Teeth



767-08-15
15 cm / 6"
5 X 6 Teeth



767-09-19
19 cm / 7 1/2"
5 X 6 Teeth



767-10-25
25 cm / 10"
5 X 6 Teeth

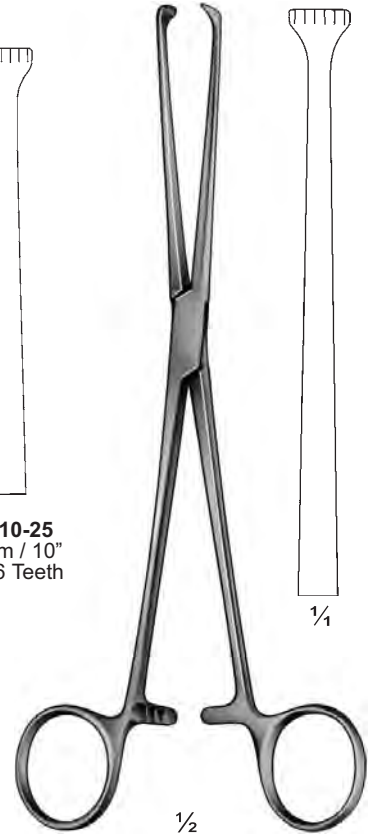

Allis
767-11-22
22 cm / 8 3/4"
5 X 6 Teeth

Darm-und Gewebefasszangen
Intestinal and Tissue Grasping Forceps
Pinces pour saisir intestins et tissus

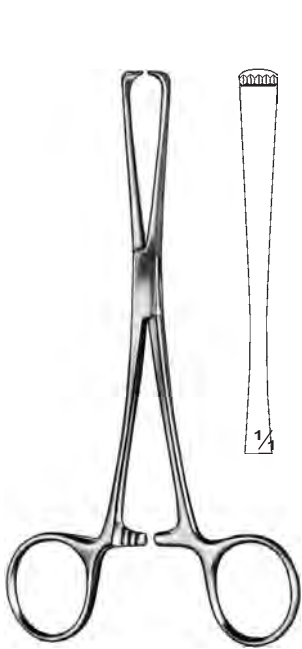

Lockwood-Allis
768-01-16 16 cm / 6¼"
768-02-20 20 cm / 8"
 4 X 5 Teeth

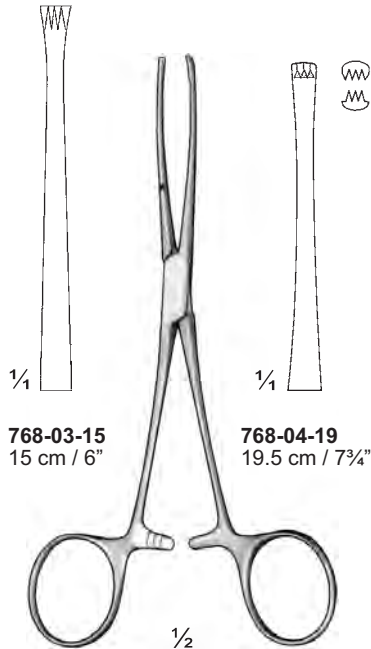

768-03-15
 15 cm / 6"
768-04-19
 19.5 cm / 7¾"

Judd-Allis
768-03-15 & 768-04-19
 3 X 4 Teeth

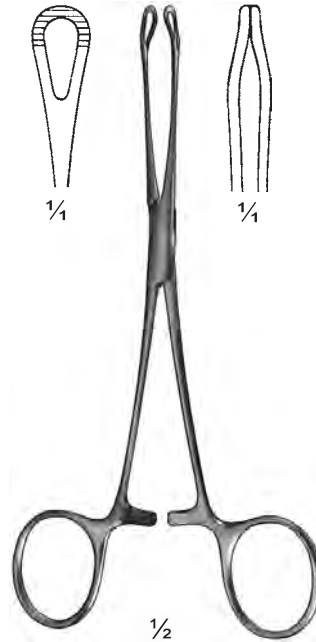

Williams
768-05-16
 16 cm / 6¼"

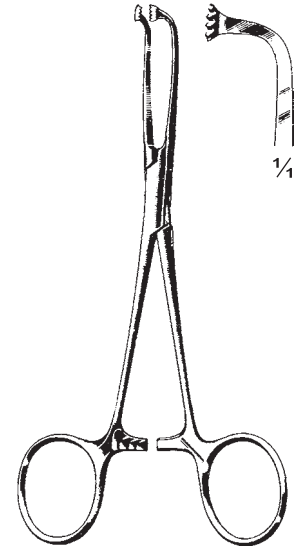

Allis-Niro
768-06-15
 15 cm / 6"
 4 X 5 Teeth



Thoms-Allis
768-07-20
 20 cm / 8"
 6 X 7 Teeth

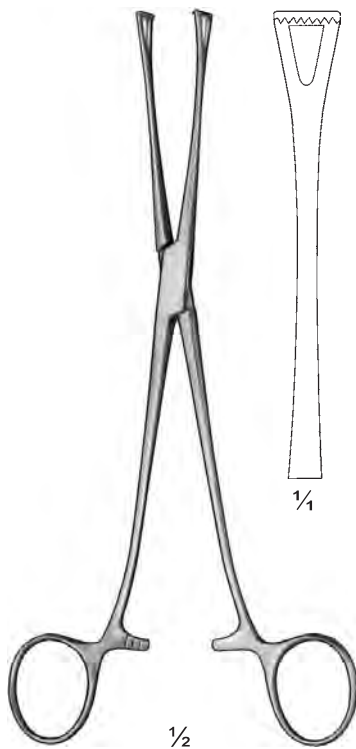

Lockwood
768-08-20
 20 cm / 8"

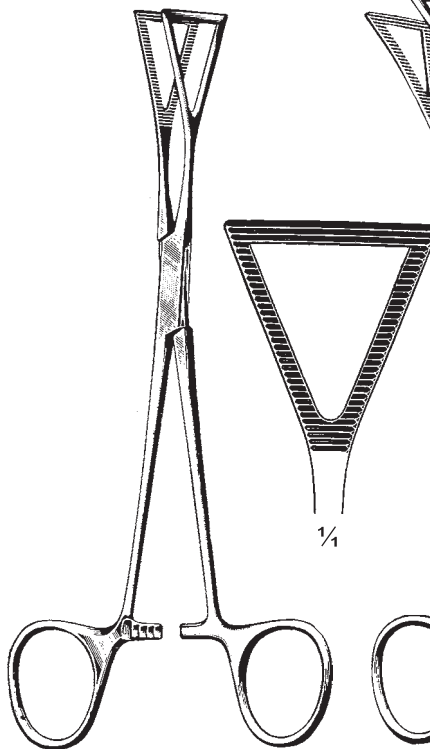

Lovelace
768-09-20
 20 cm / 8"

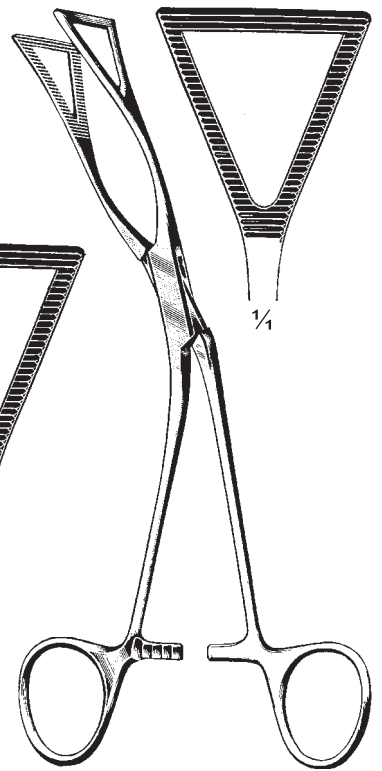

Lovelace
768-10-20
 20 cm / 8"

Darm-und Gewebefasszangen
Intestinal and Tissue Grasping Forceps
Pinces pour saisir intestins et tissus

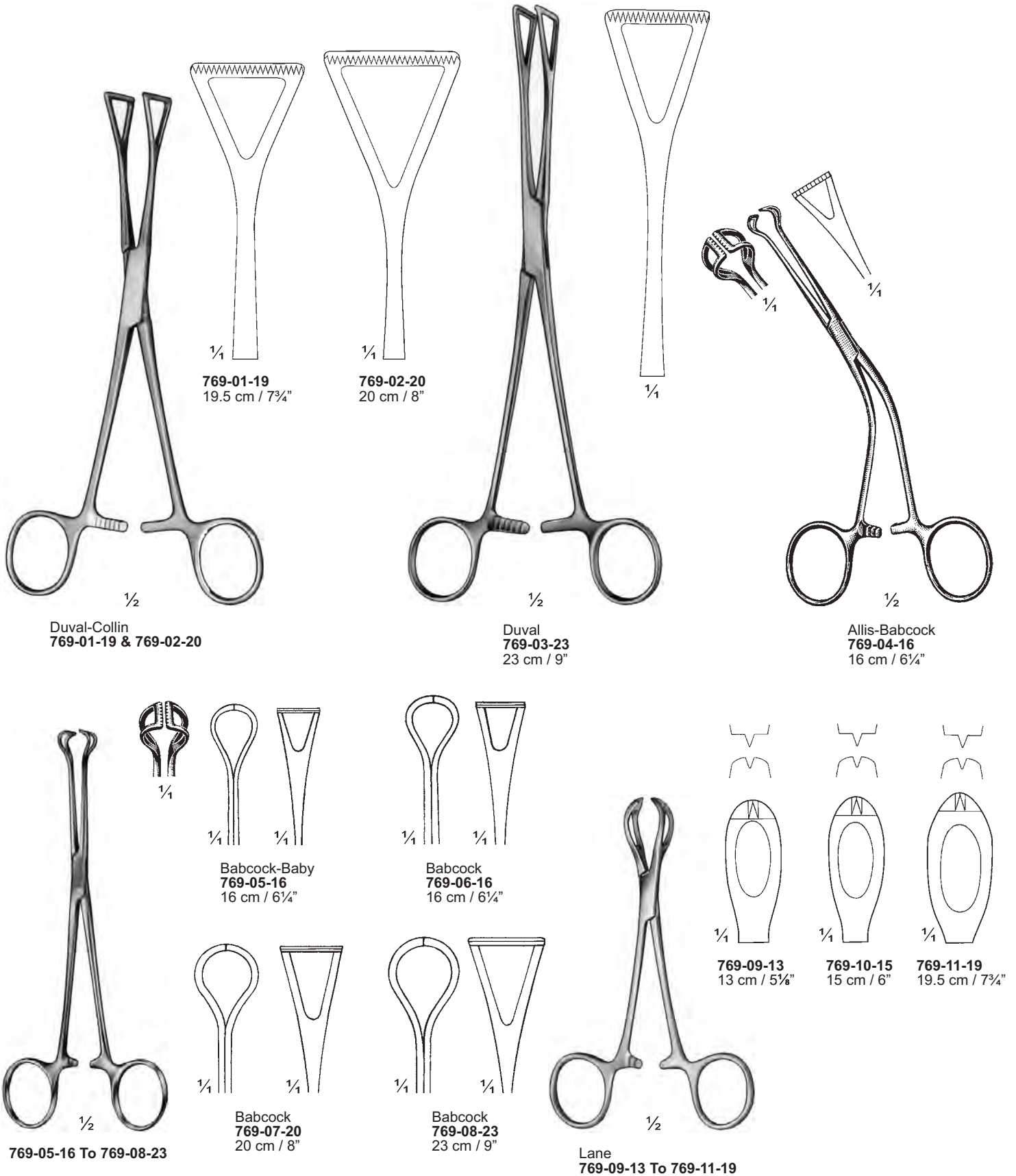

Darm-und Gewebefasszangen
Intestinal and Tissue Grasping Forceps
Pinces pour saisir intestins et tissus

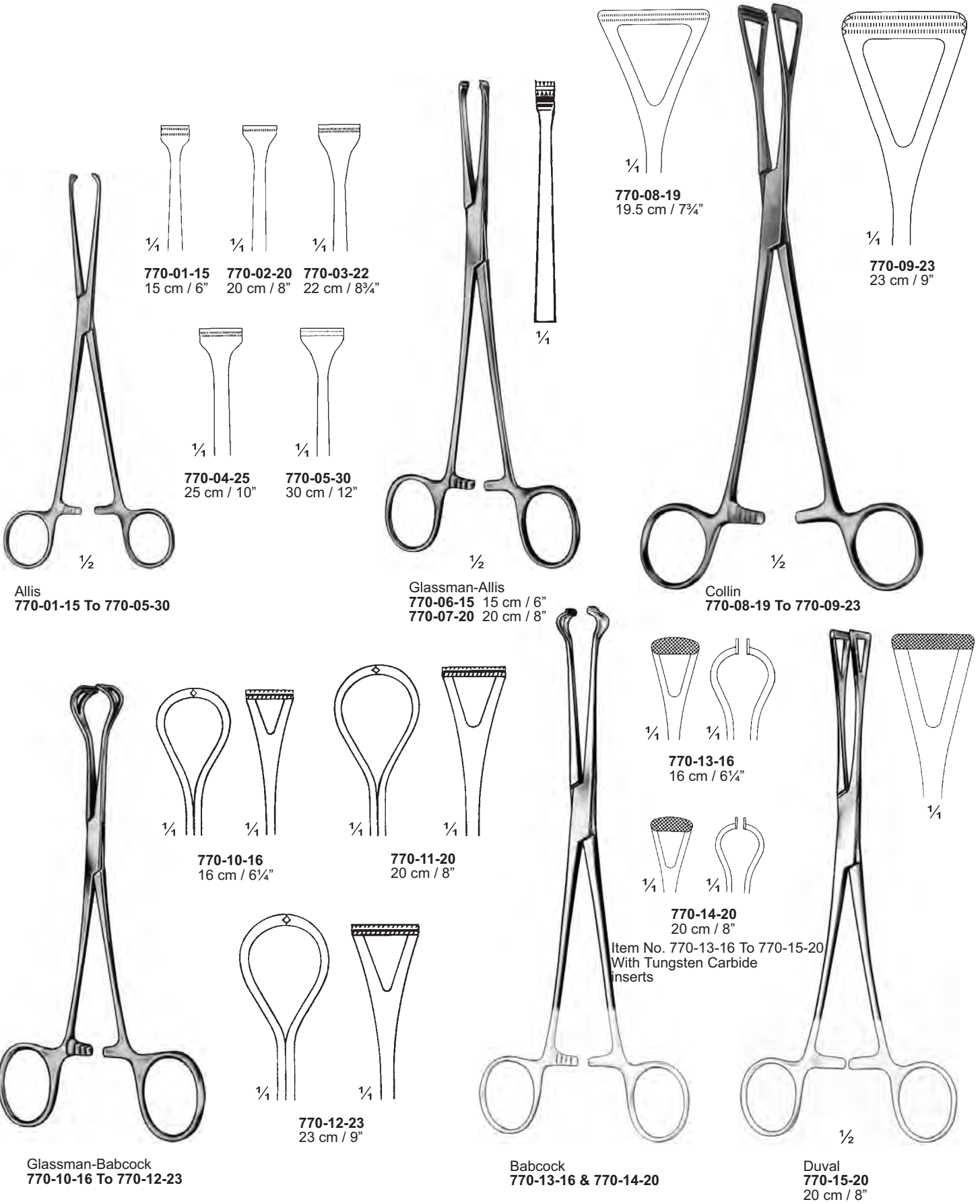

Chirurgische Pinzetten Dissecting Forceps Pincès à dissection à griffes

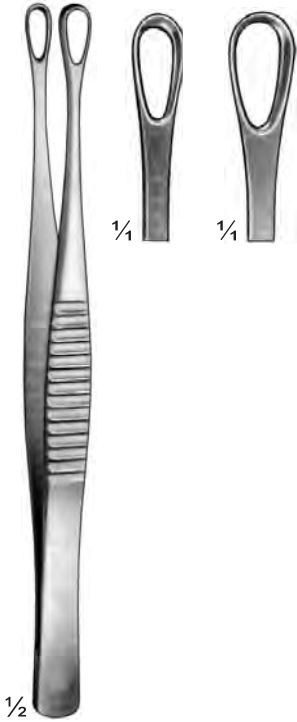

Denis-Browne
771-01-19
19 cm / 7½"

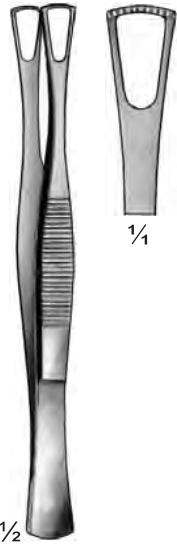

Duval
771-02-14
14 cm / 5½"



Wangensteen
771-03-15 To 771-04-23

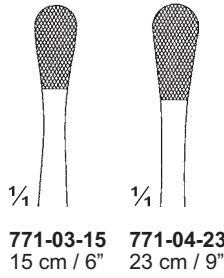

771-03-15 15 cm / 6"
771-04-23 23 cm / 9"



Stille-Barraya
771-05-18 To 771-07-25

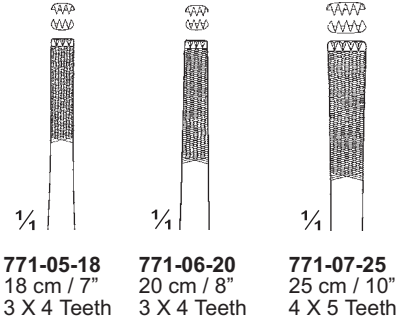

771-05-18 18 cm / 7"
3 X 4 Teeth
771-06-20 20 cm / 8"
3 X 4 Teeth
771-07-25 25 cm / 10"
4 X 5 Teeth

ULTRA LIGHT FORCEPS

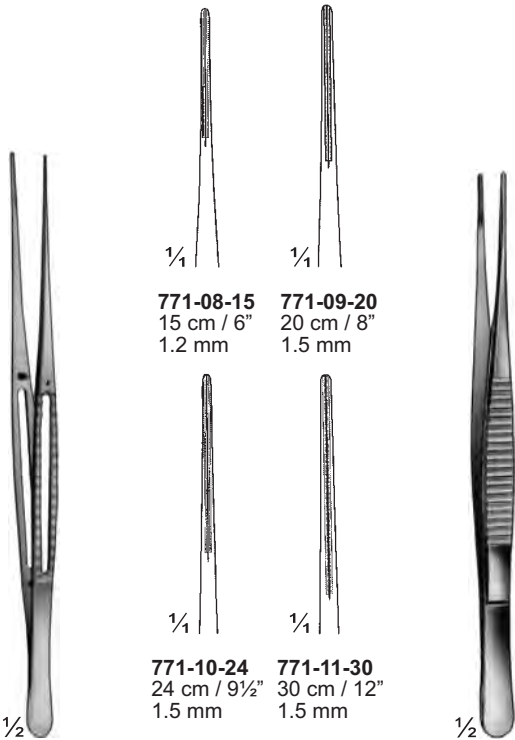

771-08-15 To 771-11-30

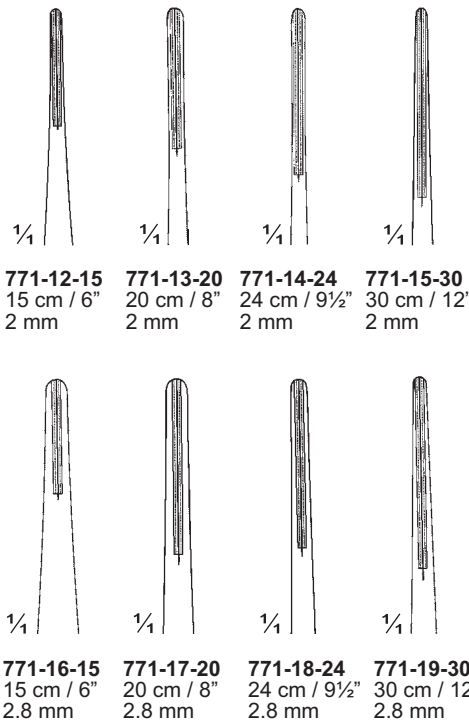

De Bakay
771-12-15 To 771-22-30

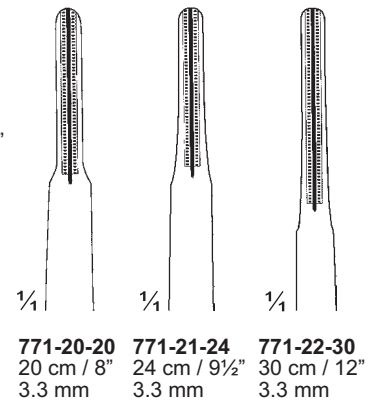

771-20-20 20 cm / 8"
3.3 mm
771-21-24 24 cm / 9½"
3.3 mm
771-22-30 30 cm / 12"
3.3 mm

**Darmklemmen
Intestinal Clamps
Pincés intestinales**



Banbridge
772-01-15 To 772-02-15
15 cm / 6"



1/4
772-02-15

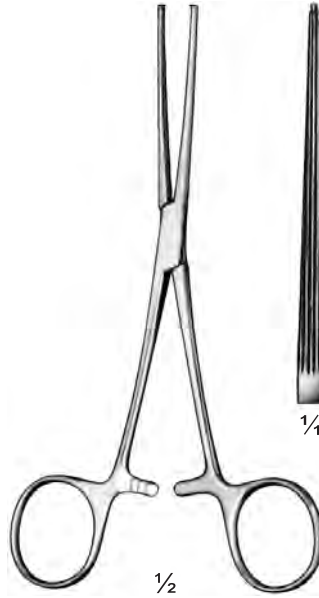

Allen
772-03-15
15 cm / 6"



1/4

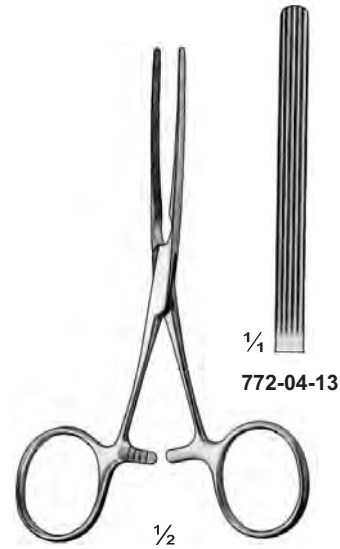

Baby-Kocher
772-04-13 To 772-05-13
13 cm / 5 1/8"
Very elastic blades



1/4
772-04-13



1/4
772-05-13

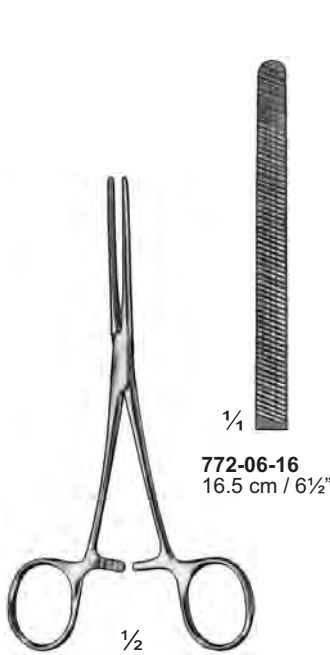

Doyen
772-06-16 To 772-09-18



1/4
772-06-16
16.5 cm / 6 1/2"



1/4
772-07-18
18 cm / 7"



1/4
772-08-16
16.5 cm / 6 1/2"

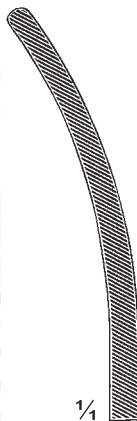

1/4
772-09-18
18 cm / 7"

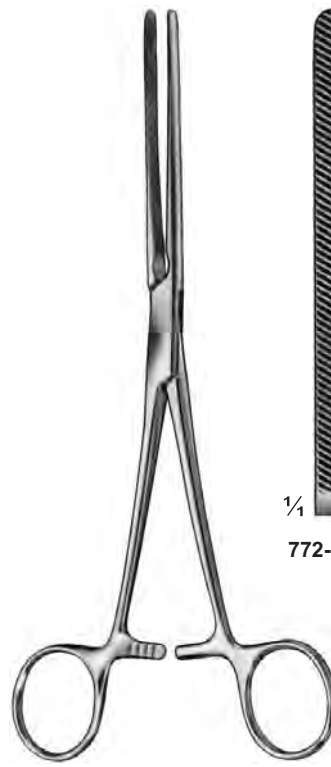

Hartmann
772-10-20 To 772-11-20
20 cm / 8"



1/4
772-10-20



1/4
772-11-20

**Darmklemmen
Intestinal Clamps
Pincas intestinales**

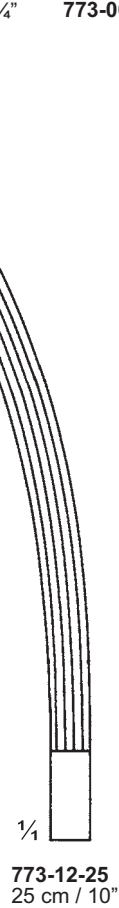
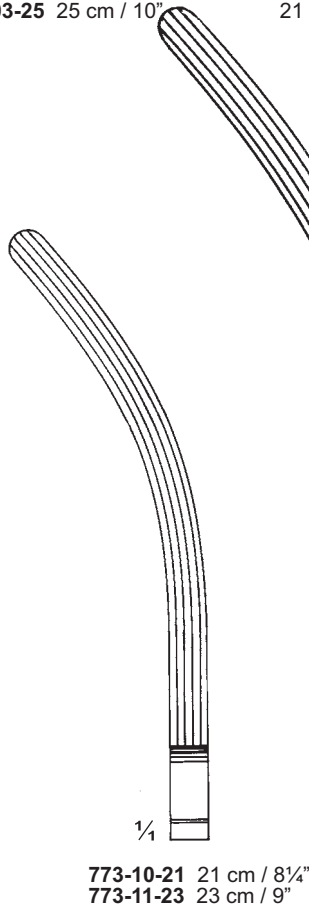
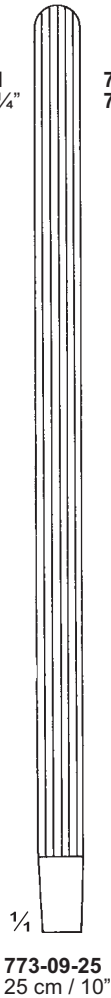
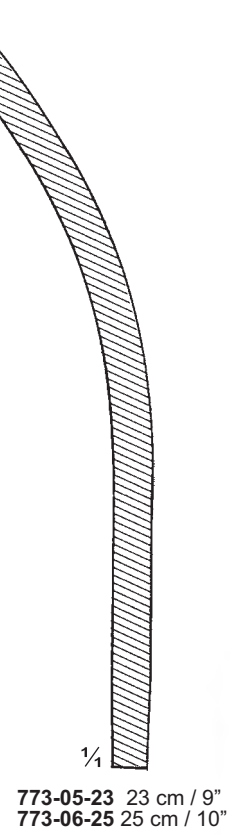
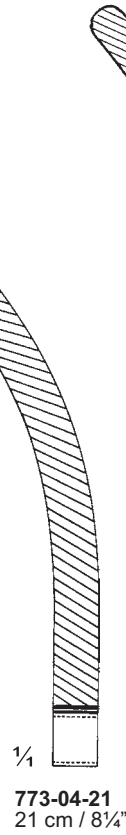
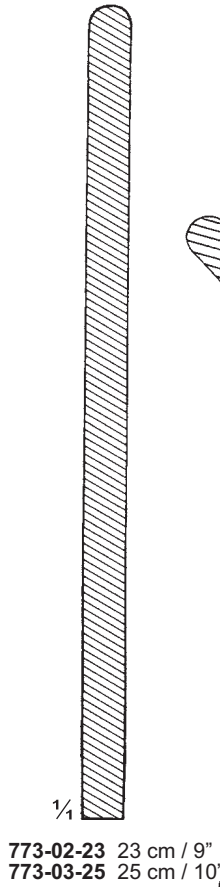
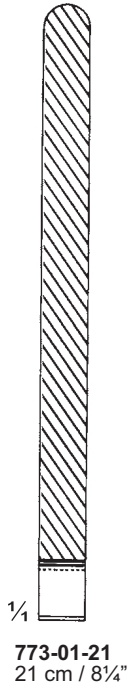

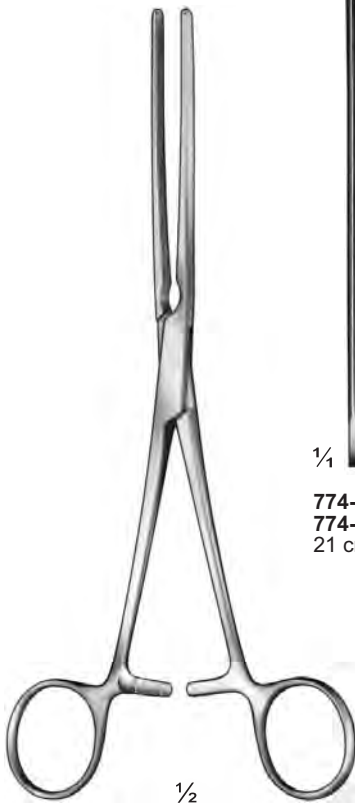

1/2

Kocher
774-01-21 To 774-06-28
Very elastic blades

1/4

774-01-21
774-07-21
21 cm / 8 1/4"

1/4

774-02-23
774-08-23
23 cm / 9"

1/4

774-03-25
774-09-25
25 cm / 10"

1/4

774-04-22
774-10-22
22 cm / 8 3/4"

1/4

774-05-25
774-11-25
25 cm / 10"

1/4

774-06-28
774-12-28
28 cm / 11"

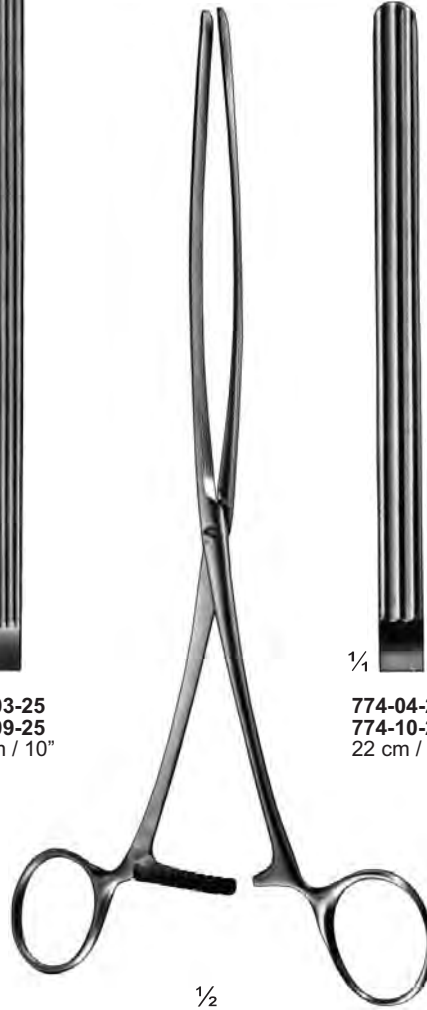

1/2

Kocher
774-07-21 To 774-12-28
Very elastic blades



Kocher
775-01-21 To 775-06-28
Very elastic blades

Kocher
775-07-21 To 775-12-28
Very elastic blades

**Darmklemmen
Intestinal Clamps
Pincers intestinales**



776-01-60 & 776-02-80
23 cm / 9"

1/2

776-01-60
60 mm



1/4

776-02-80
80 mm



1/4

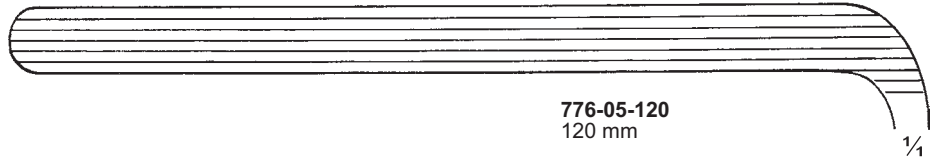

776-05-120
120 mm

1/4

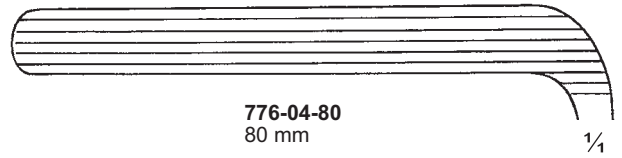

776-04-80
80 mm

1/4

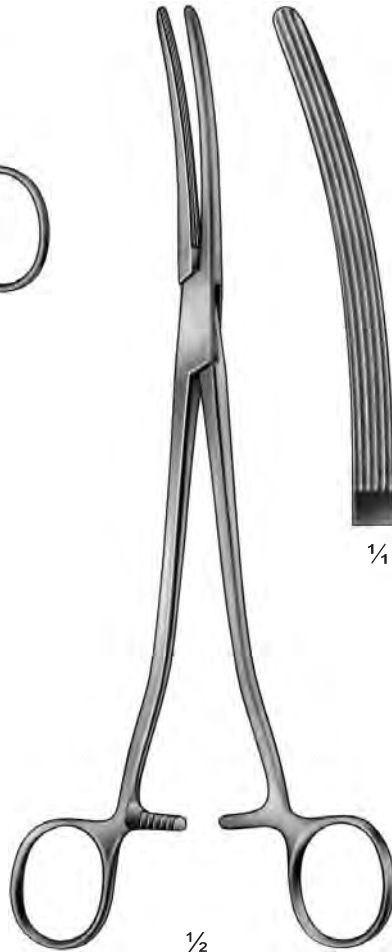

Parker-Kerr
776-03-25
25 cm / 10"

1/2

1/4



Mikulicz
776-04-80 To 776-05-120
19 cm / 7 1/2"

1/2

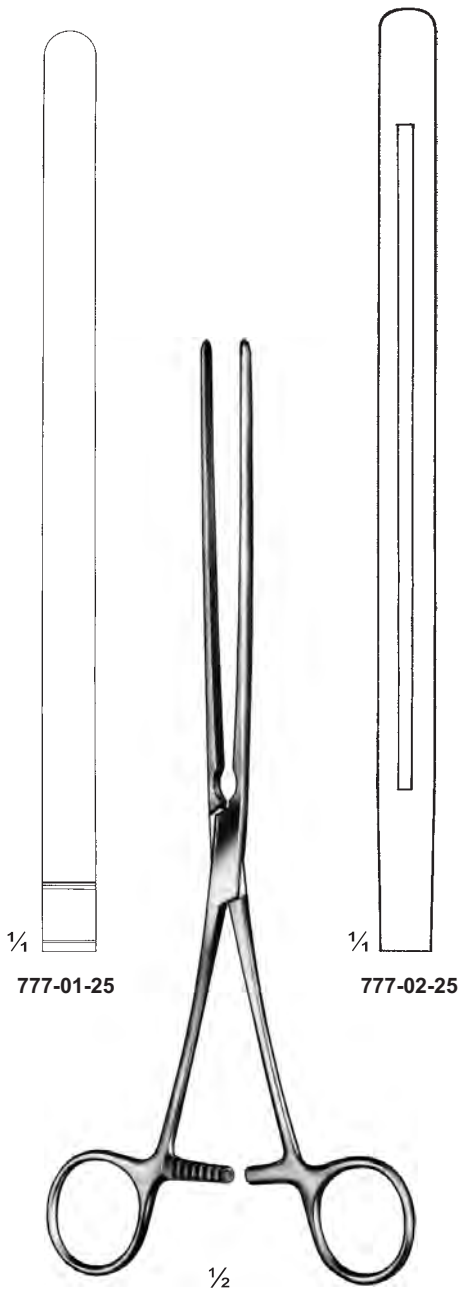

Schudder
777-01-25 & 777-02-25
25 cm / 10"

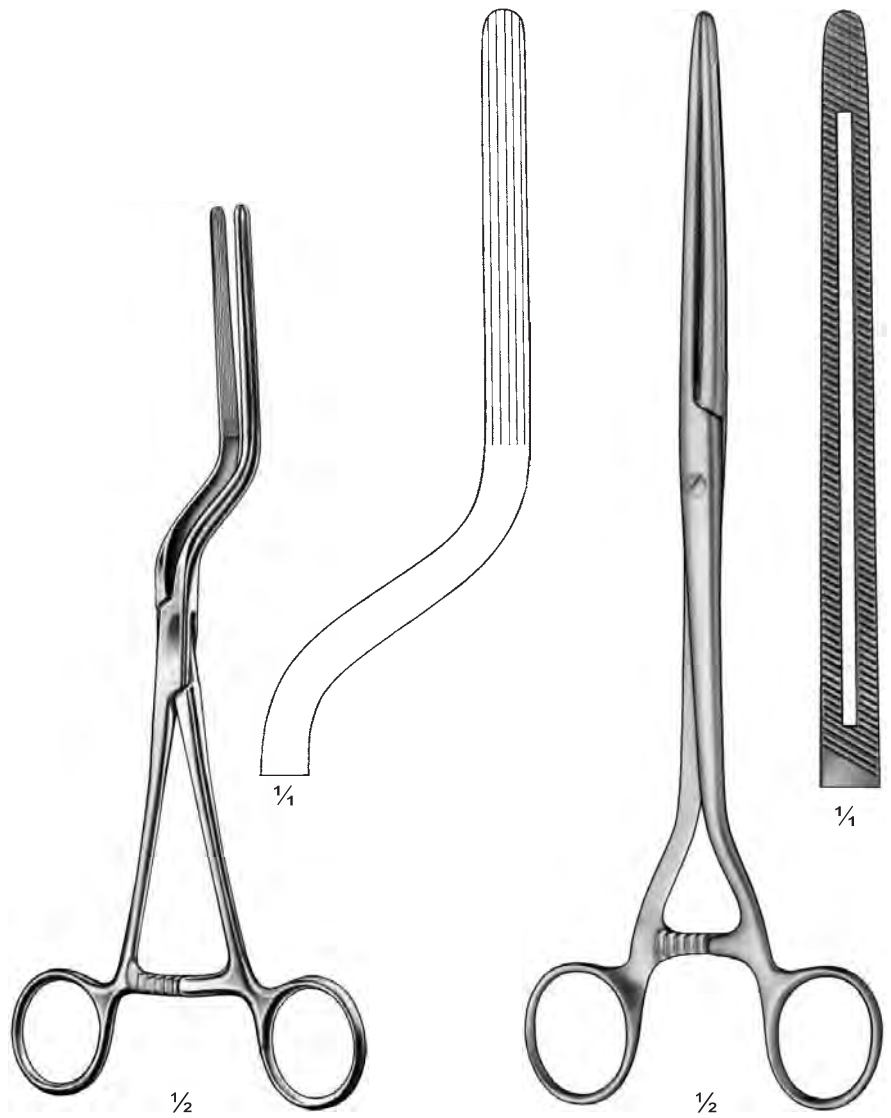

Brunner
777-03-24
24 cm / 9½"

Moynihan
777-04-28
28 cm / 11"

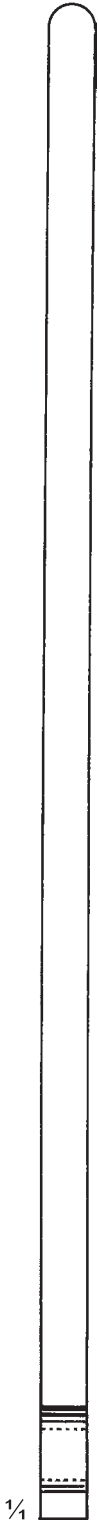

778-01-33

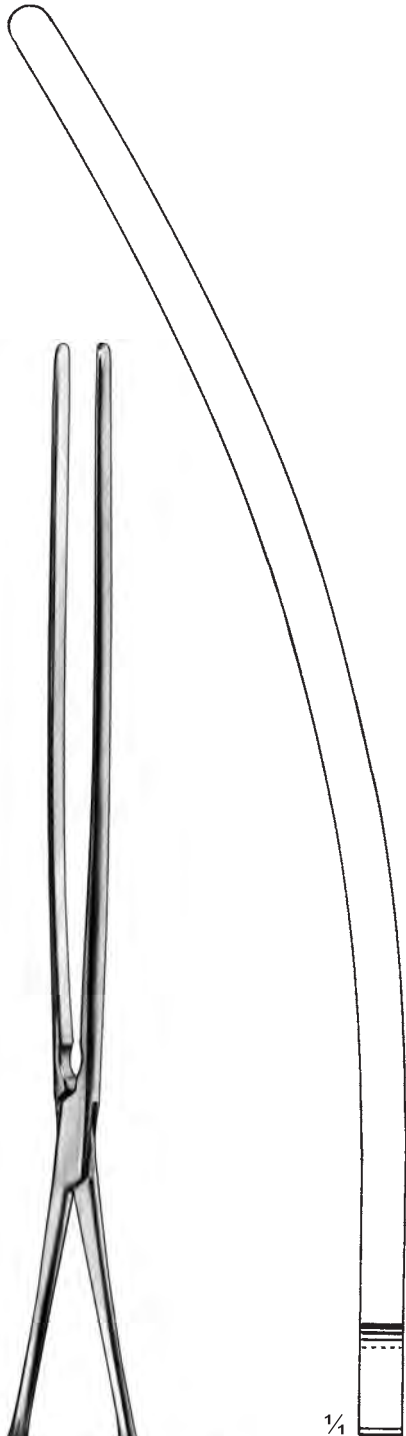

778-02-33



Schudder
778-01-33 & 778-02-33
33 cm / 13"

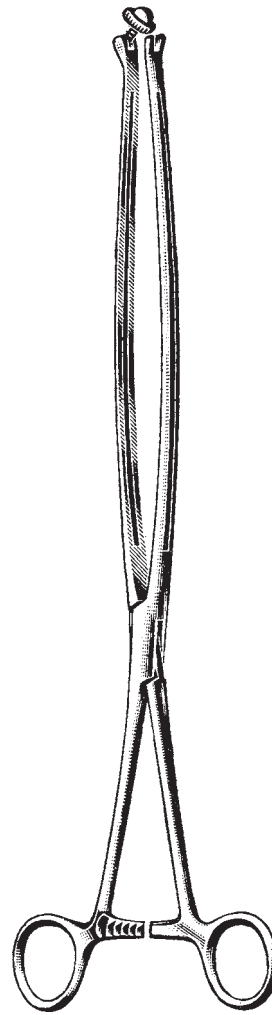

Schudder
778-03-36
36 cm / 14"

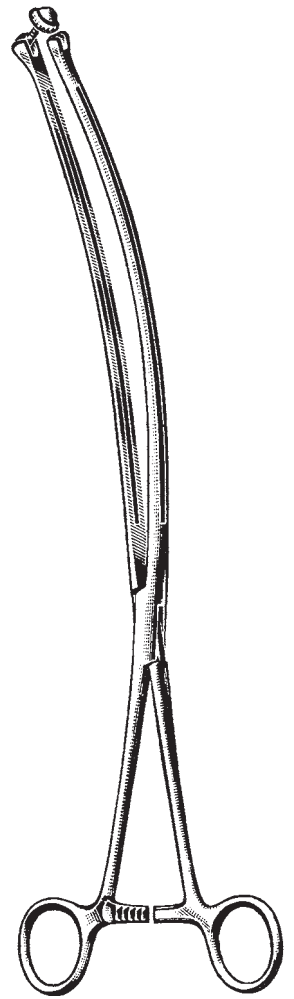

Schudder
778-04-36
36 cm / 14"

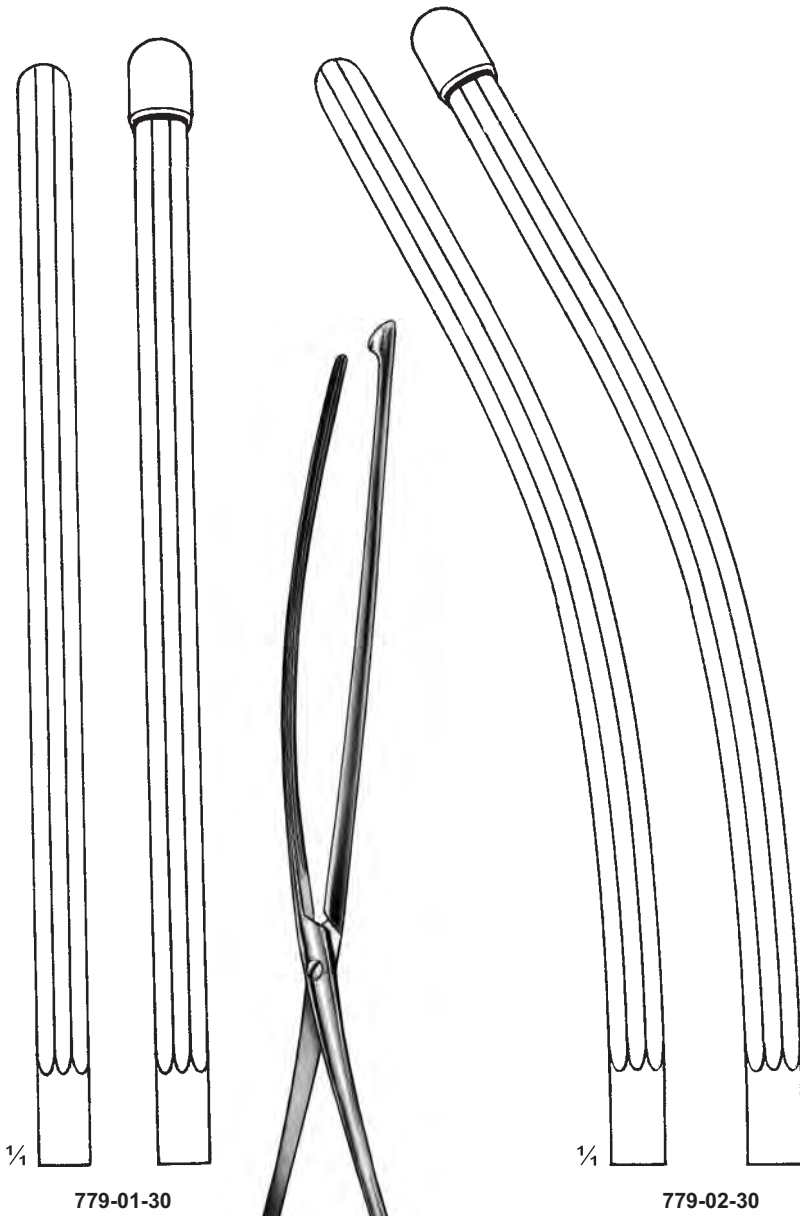

779-01-30

779-02-30

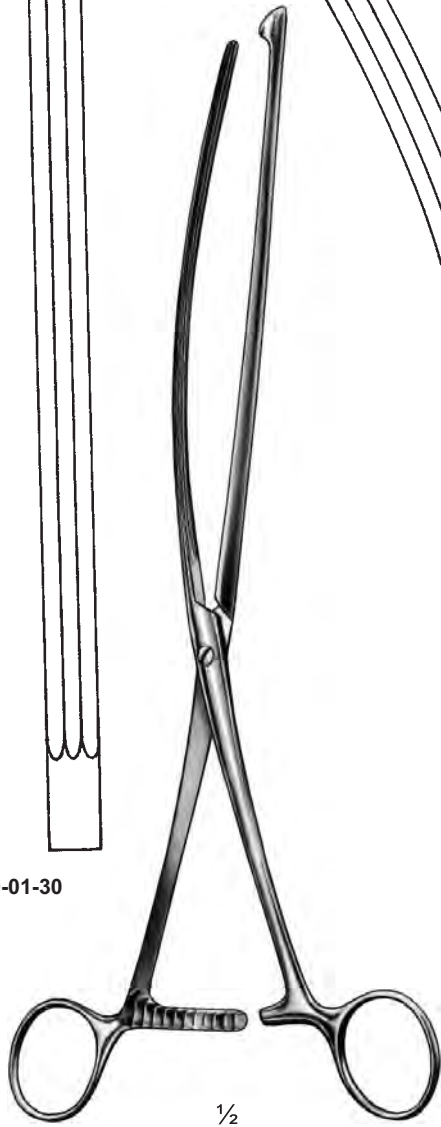

779-01-30 & 779-02-30
30 cm / 12"

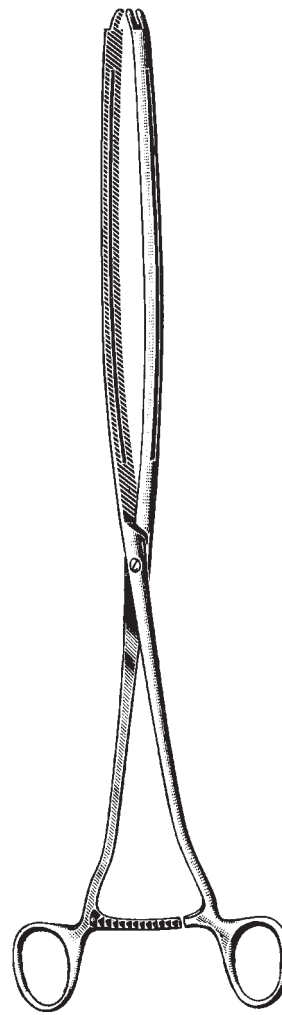

Moynihan
779-03-36
36 cm / 14"

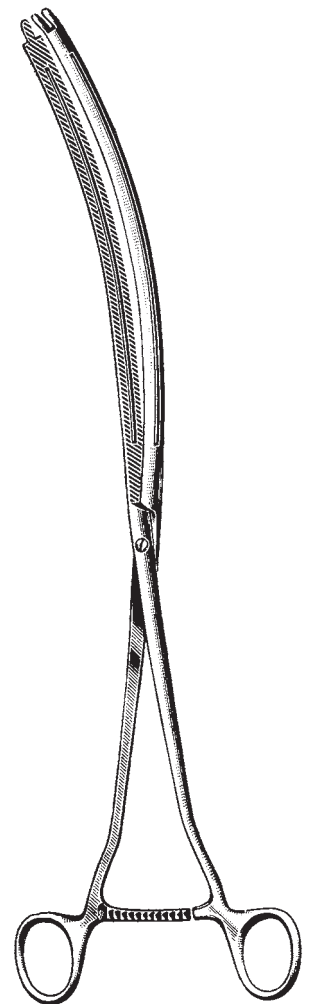

Moynihan
779-04-36
36 cm / 14"



780-01-15 With pin
780-02-15 Without pin



1/2

Payr-Baby
780-01-15 To 780-02-15
15 cm / 6"



1/2

Payr
780-03-18 To 780-10-35

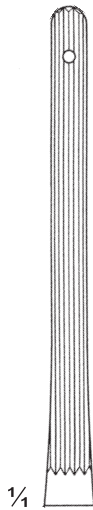

1/4

780-03-18 With pin
780-04-18 Without pin
18 cm / 7"



1/4

780-05-21 With pin
780-06-21 Without pin
21 cm / 8 1/4"

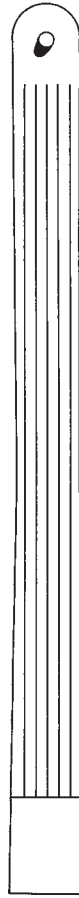

1/4

780-07-29 With pin
780-08-29 Without pin
29 cm / 11 1/2"



1/4

780-09-35 With pin
780-10-35 Without pin
35 cm / 13 3/4"

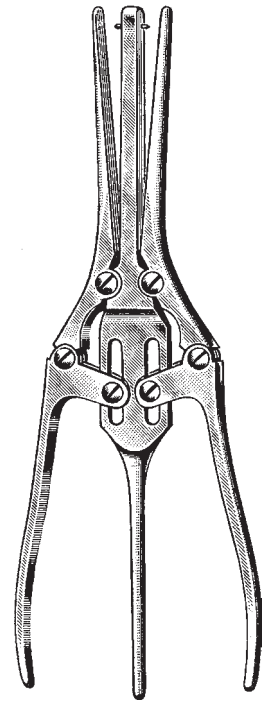

Partsch
780-11-22
22.5 cm / 9 3/4"



Lane
781-01-30
30 cm / 12"

Lane
781-02-30
30 cm / 12"



$\frac{1}{2}$
Baberer
782-01-36
36 cm / 14"

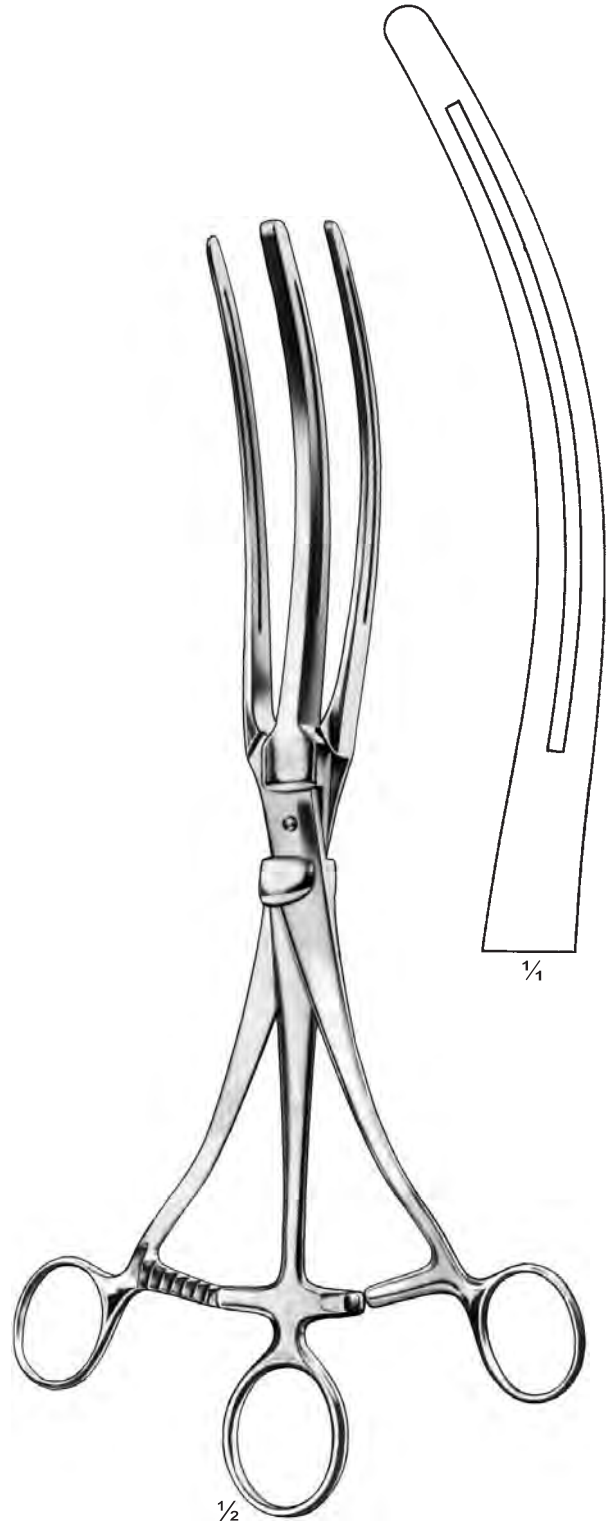

$\frac{1}{2}$
Roosevelt
782-02-34
34 cm / 13½"

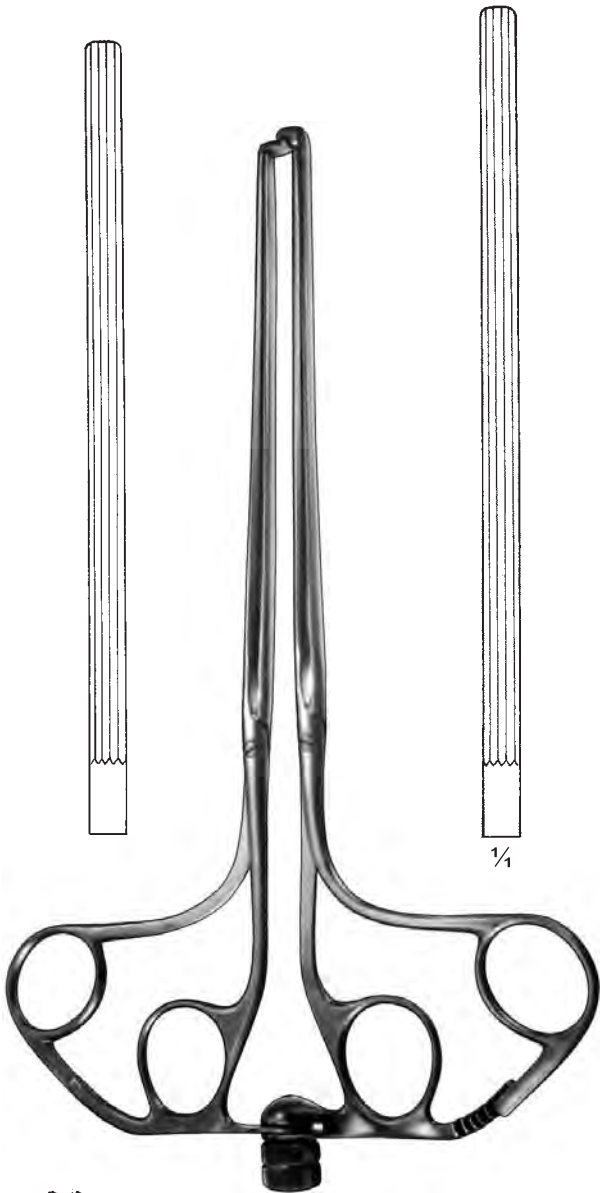

1/4

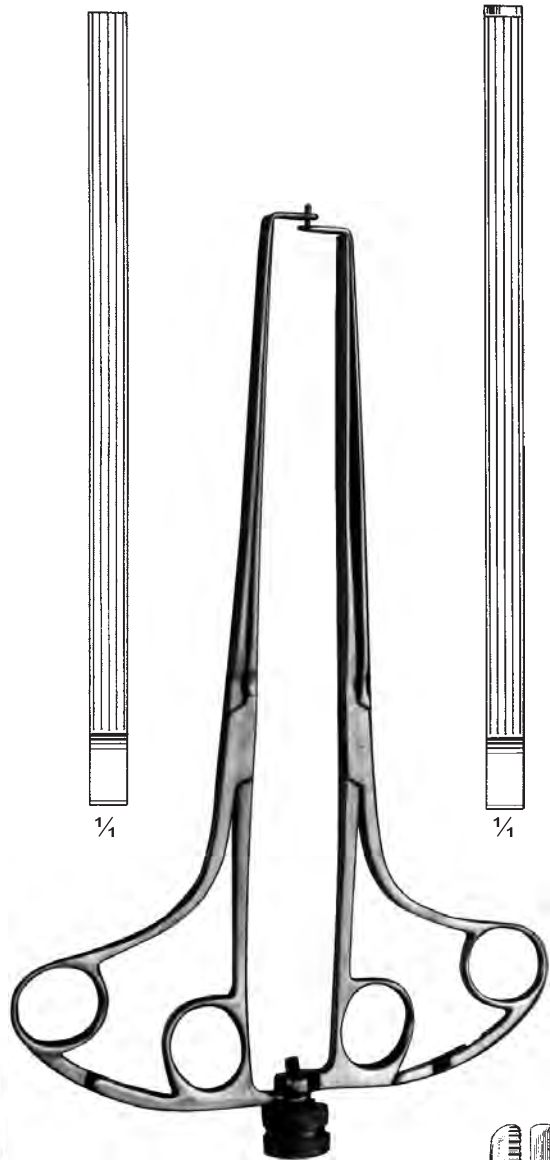

1/4

1/4

Abadie
783-01-22 22 cm / 8 3/4"
783-02-27 27 cm / 10 1/2"

Abadie
783-03-22 22 cm / 8 3/4"
783-04-27 27 cm / 10 1/2"

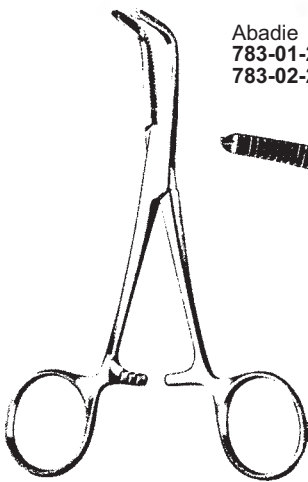

1/4

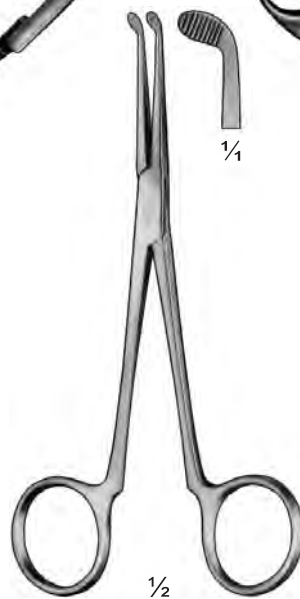

1/2



1/4

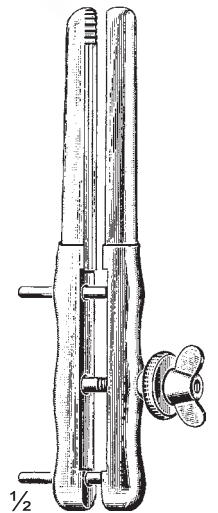

1/2

Kleinschmidt
783-05-13
13 cm / 5 1/8"
Appendectomy clamp
1 X 2 Teeth

Benson
783-06-15
15 cm / 6"
Pylorus spreader

Stetten
783-07-13
13.5 cm / 5 1/4"

**Darmklemmen
Intestinal Clamps
Pincas intestinales**

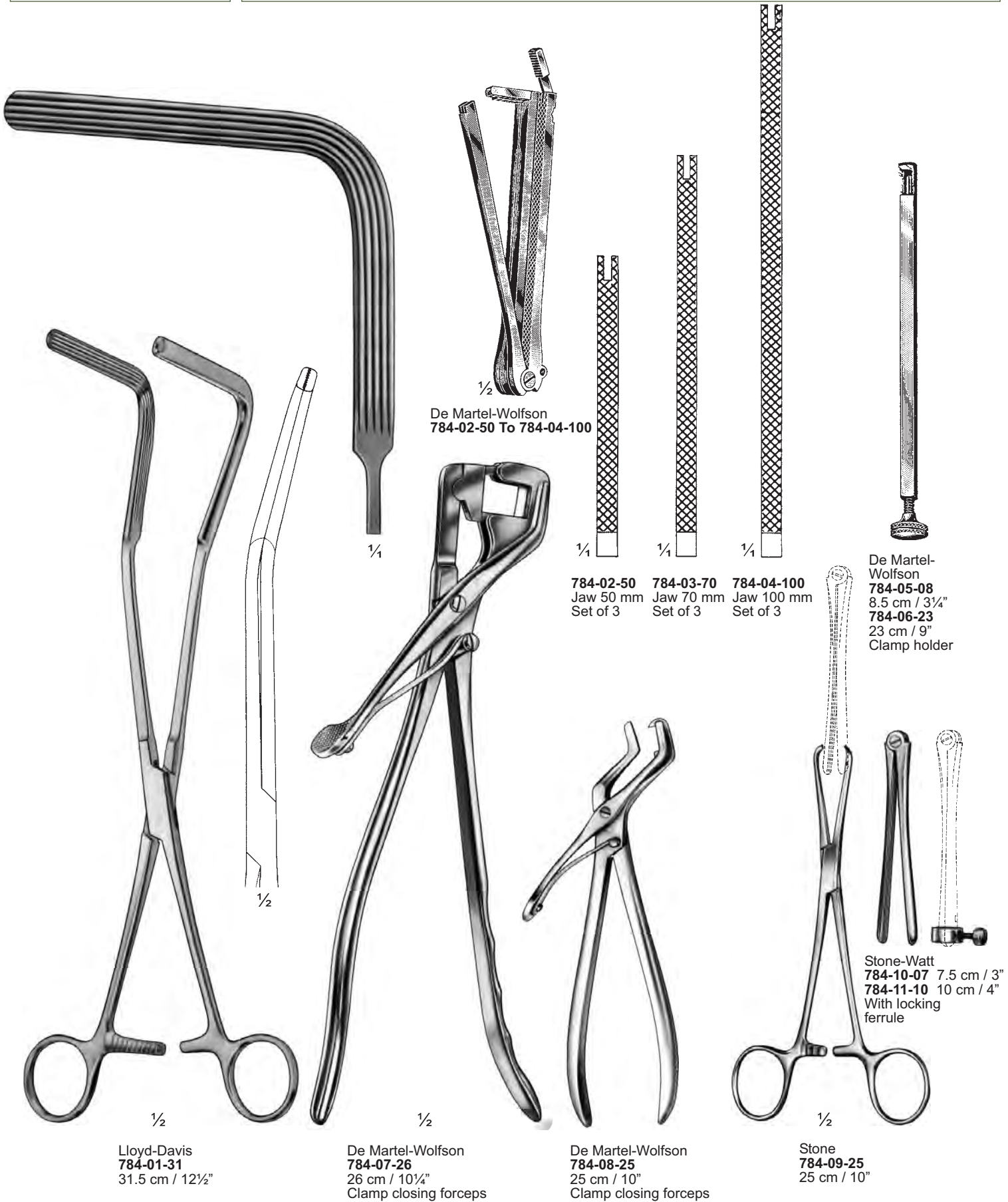

De Martel-Wolfson
784-02-50 To 784-04-100

784-02-50 Jaw 50 mm Set of 3
784-03-70 Jaw 70 mm Set of 3
784-04-100 Jaw 100 mm Set of 3

De Martel-Wolfson
784-05-08 8.5 cm / 3¼"
784-06-23 23 cm / 9"
 Clamp holder

Lloyd-Davis
784-01-31
31.5 cm / 12½"

De Martel-Wolfson
784-07-26
26 cm / 10¼"
Clamp closing forceps

De Martel-Wolfson
784-08-25
25 cm / 10"
Clamp closing forceps

Stone
784-09-25
25 cm / 10"

Stone-Watt
784-10-07 7.5 cm / 3"
784-11-10 10 cm / 4"
 With locking ferrule

**Darmklemmen
Intestinal Clamps
Pincés intestinales**



Doyen
785-01-13 To 785-10-23

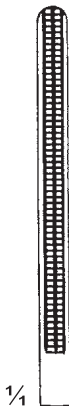

785-01-13
13 cm / $5\frac{1}{8}$ "

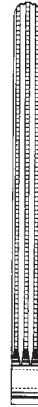

785-02-16
16 cm / $6\frac{1}{4}$ "



785-03-18
18 cm / 7"



785-04-21
21 cm / $8\frac{1}{4}$ "

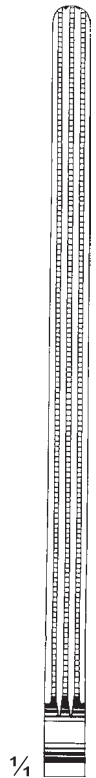

785-05-23
23 cm / 9"

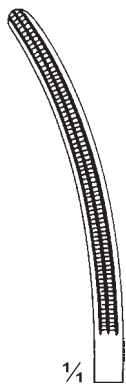

785-06-13
13 cm / $5\frac{1}{8}$ "

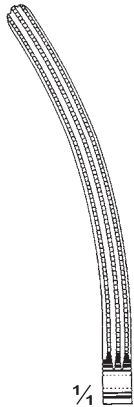

785-07-16
16 cm / $6\frac{1}{4}$ "

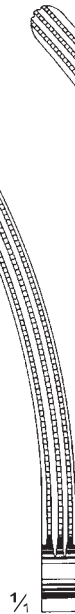

785-08-18
18 cm / 7"



785-09-21
21 cm / $8\frac{1}{4}$ "



785-10-23
23 cm / 9"

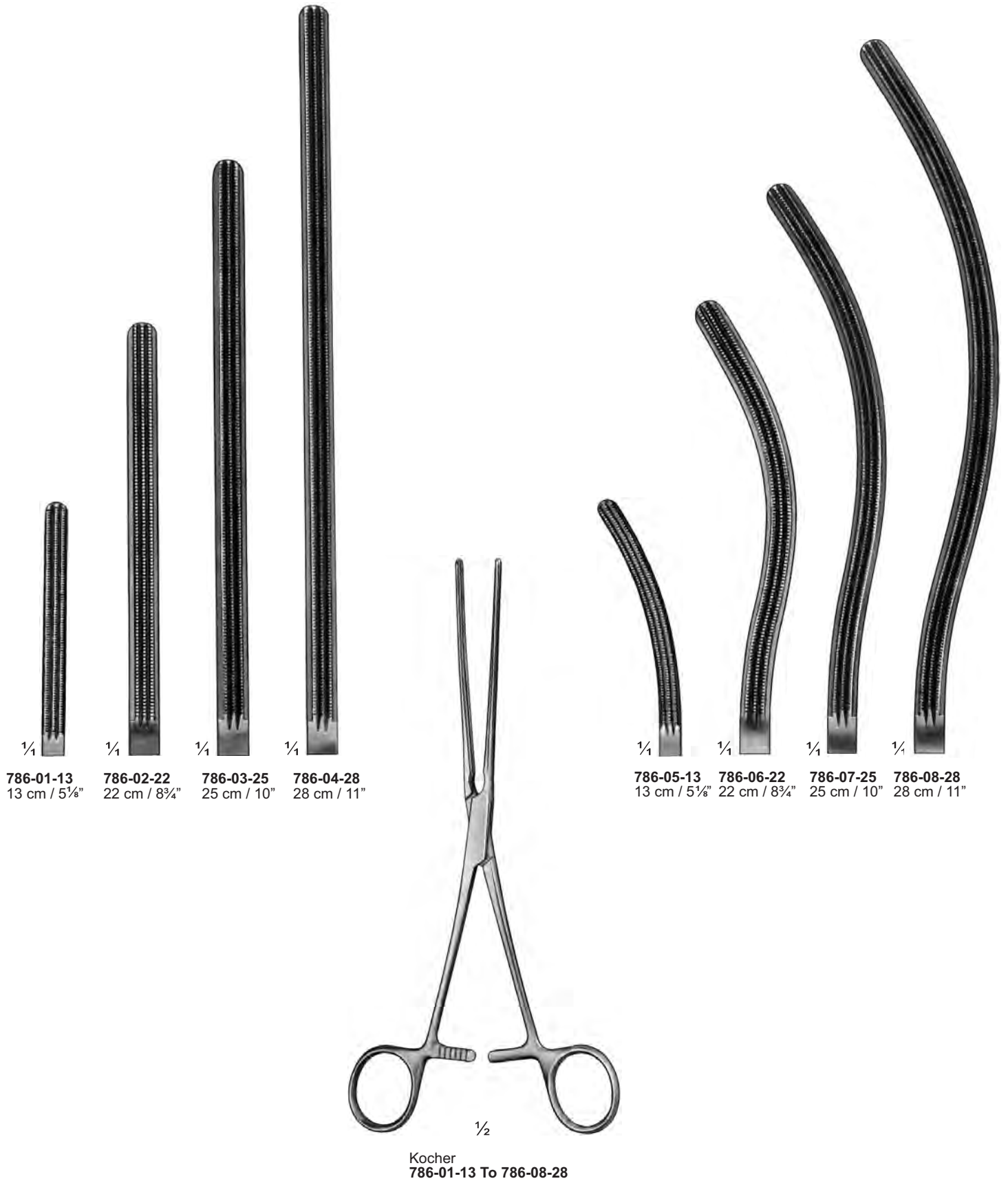

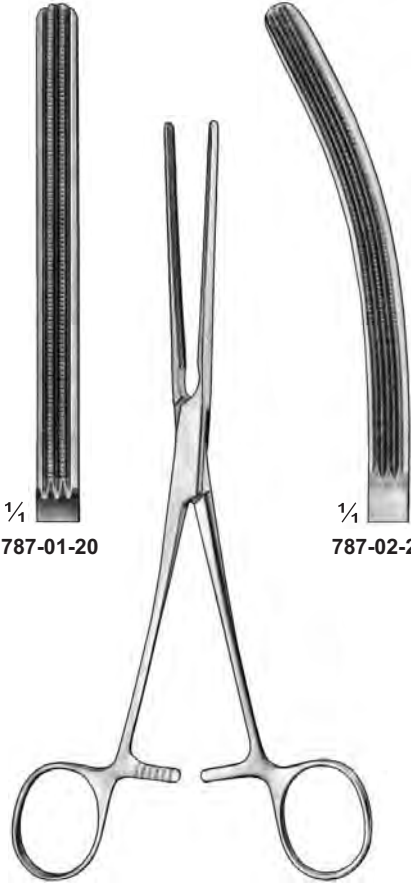

$\frac{1}{4}$
787-01-20

$\frac{1}{4}$
787-02-20

Hartmann
787-01-20 & 787-02-20
20 cm / 8"

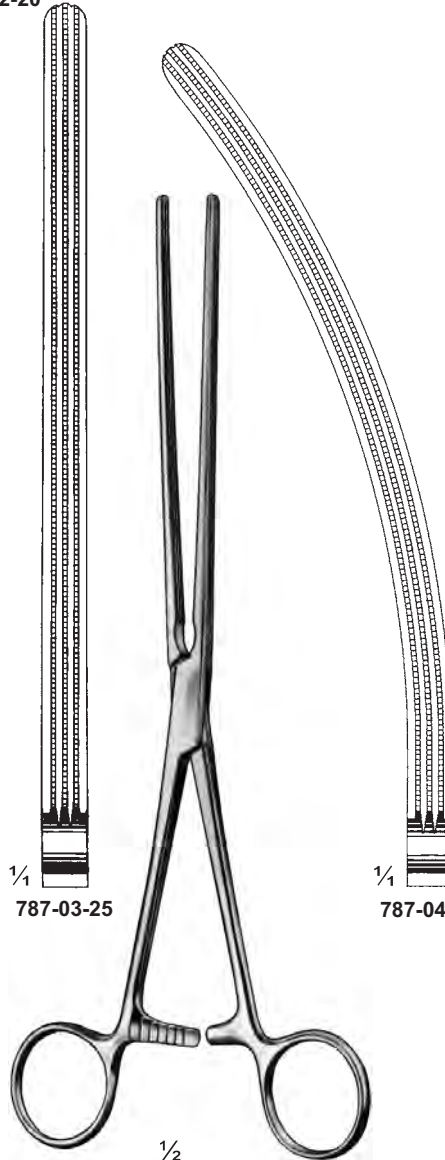

$\frac{1}{4}$
787-03-25

$\frac{1}{4}$
787-04-25

$\frac{1}{2}$
Mayo-Robson
787-03-25 & 787-04-25
25 cm / 10"



$\frac{1}{4}$
787-05-33

$\frac{1}{4}$
787-06-33

$\frac{1}{2}$
Scudder
787-05-33 & 787-06-33
33 cm / 13"

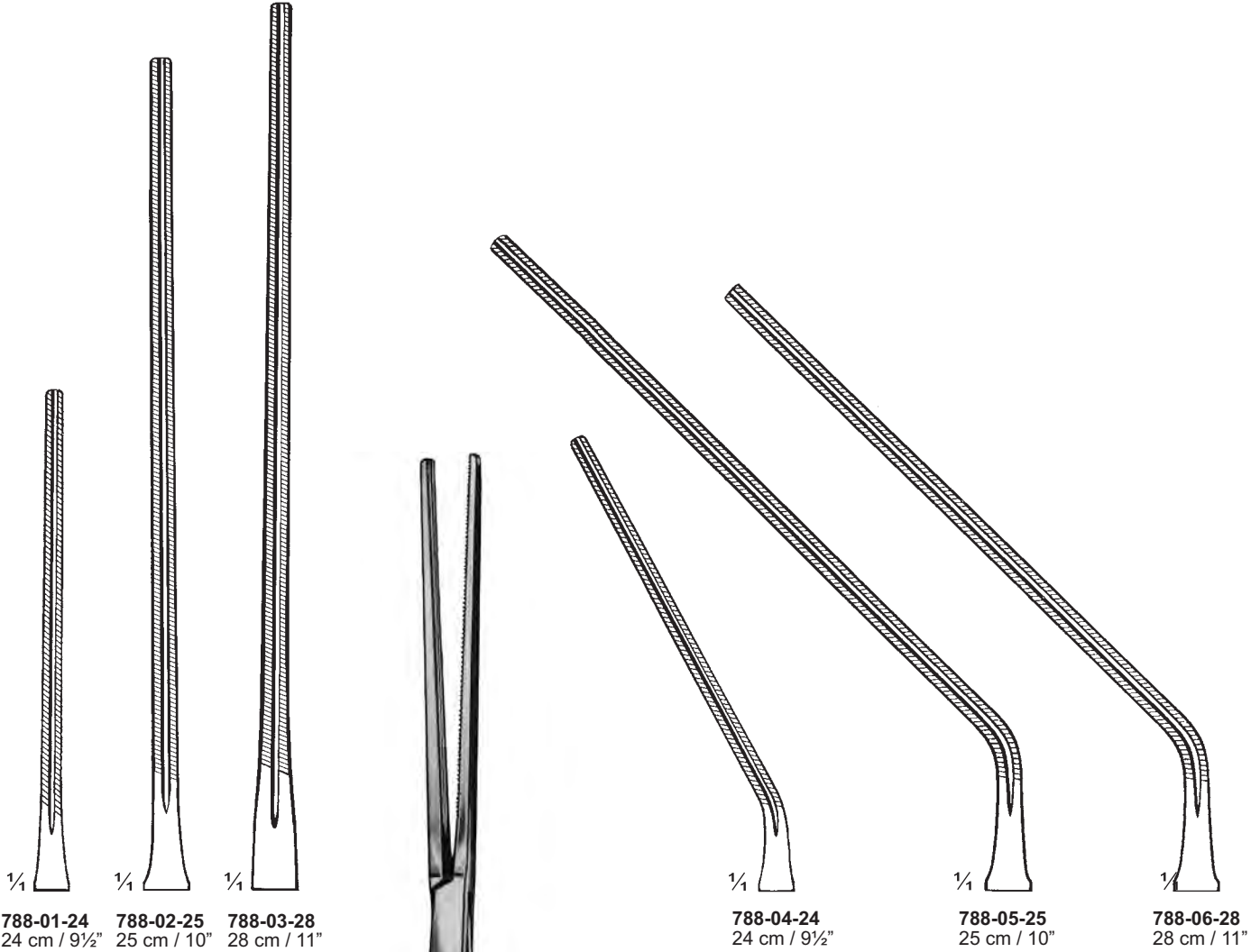

788-01-24 24 cm / 9½"
788-02-25 25 cm / 10"
788-03-28 28 cm / 11"

788-04-24 24 cm / 9½"

788-05-25 25 cm / 10"

788-06-28 28 cm / 11"

Glassman
788-01-24 To 788-06-28

**Darmklemmen
Intestinal Clamps
Pincers intestinales**

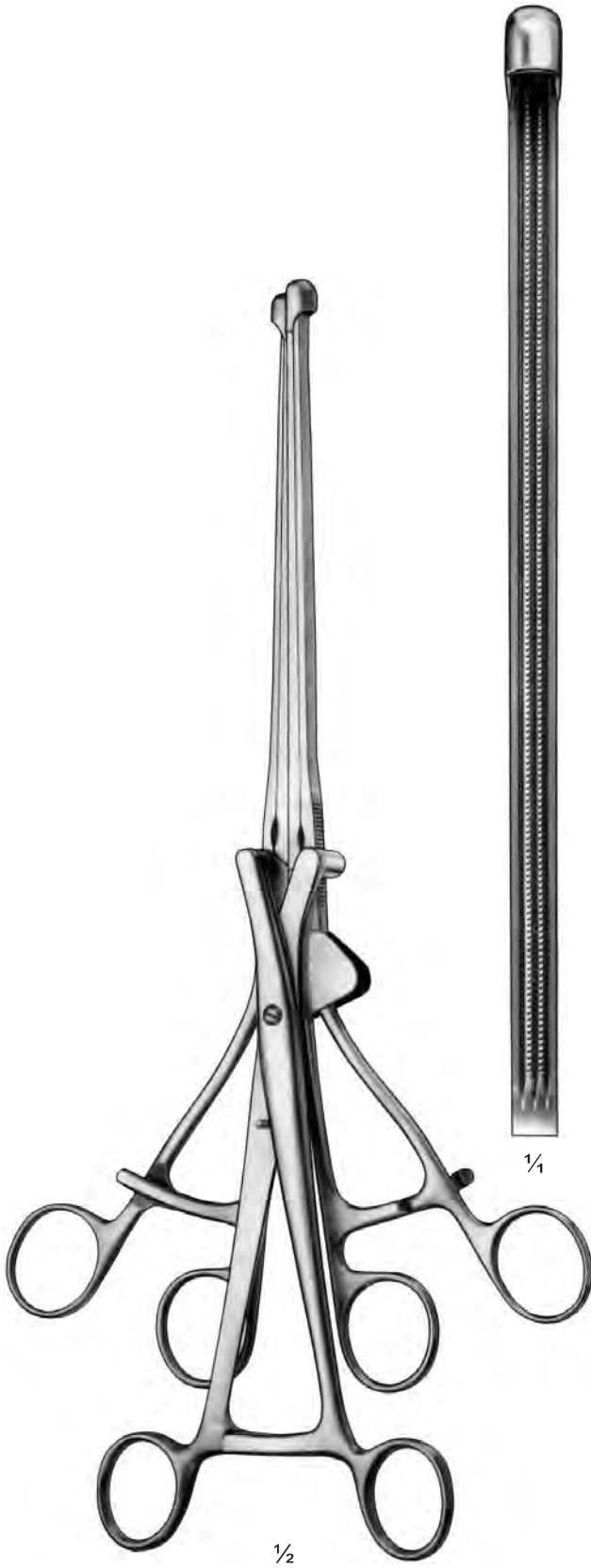

Haberer
789-01-36
36 cm / 14¼"



¼



¼



¼

¼

¼

789-02-25
25 cm / 10"

789-03-26
26.5 cm / 10½"

789-04-27
27.5 cm / 10¾"

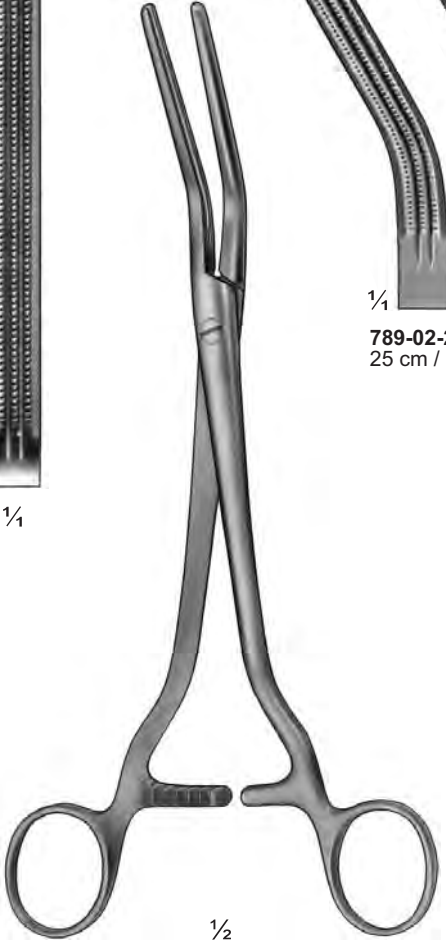

½

Dick
789-02-25 To 789-04-27

Anastomosenklemmen
Anastomosis Clamps
Pinces-clamps à anastomose

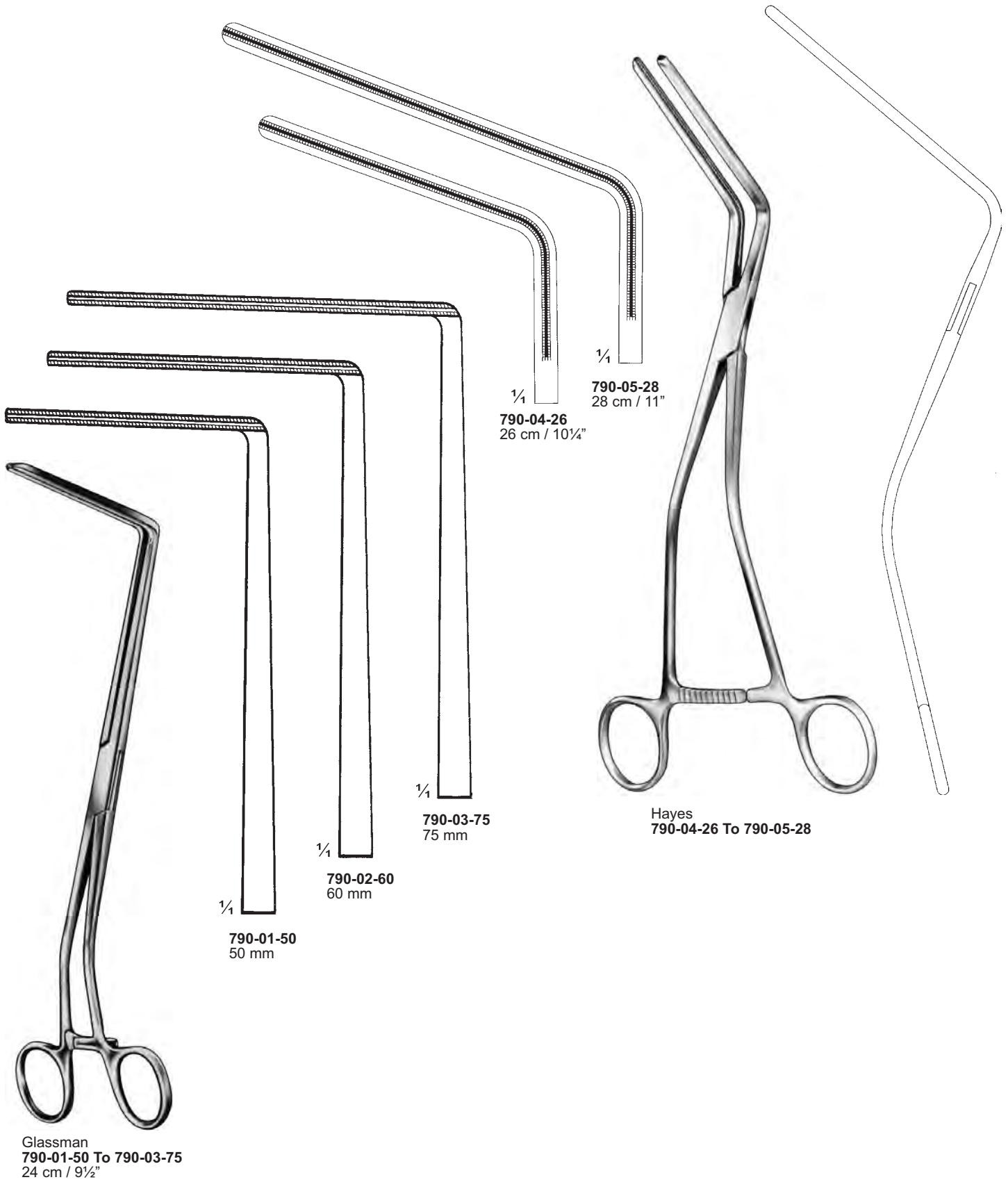

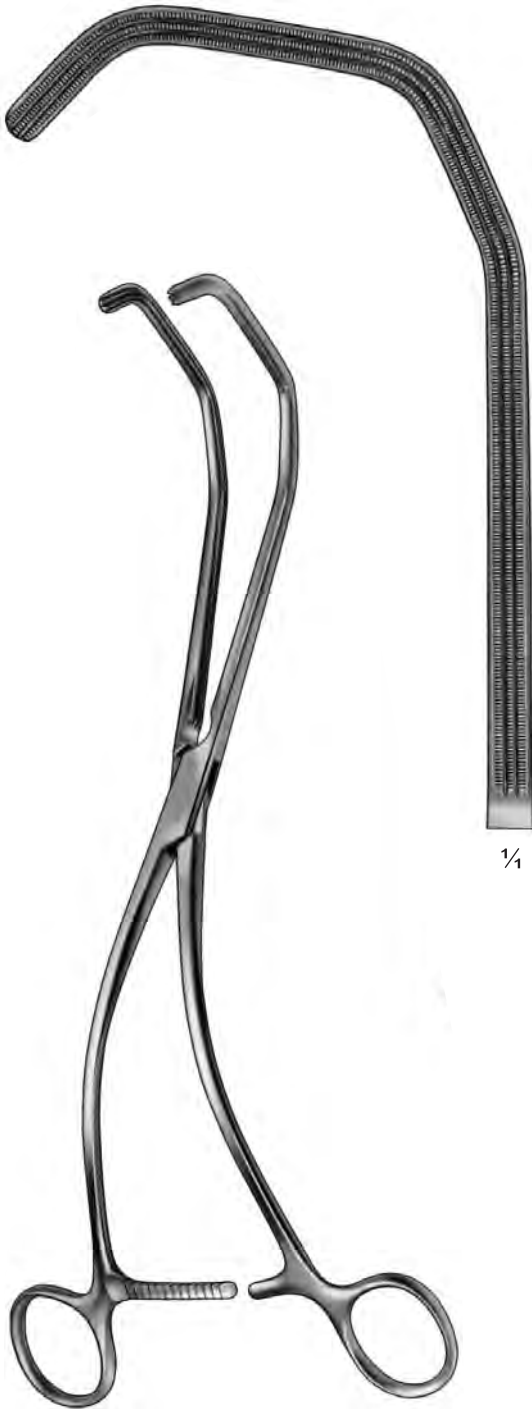

Kersting
791-01-27
27 cm / 10½"

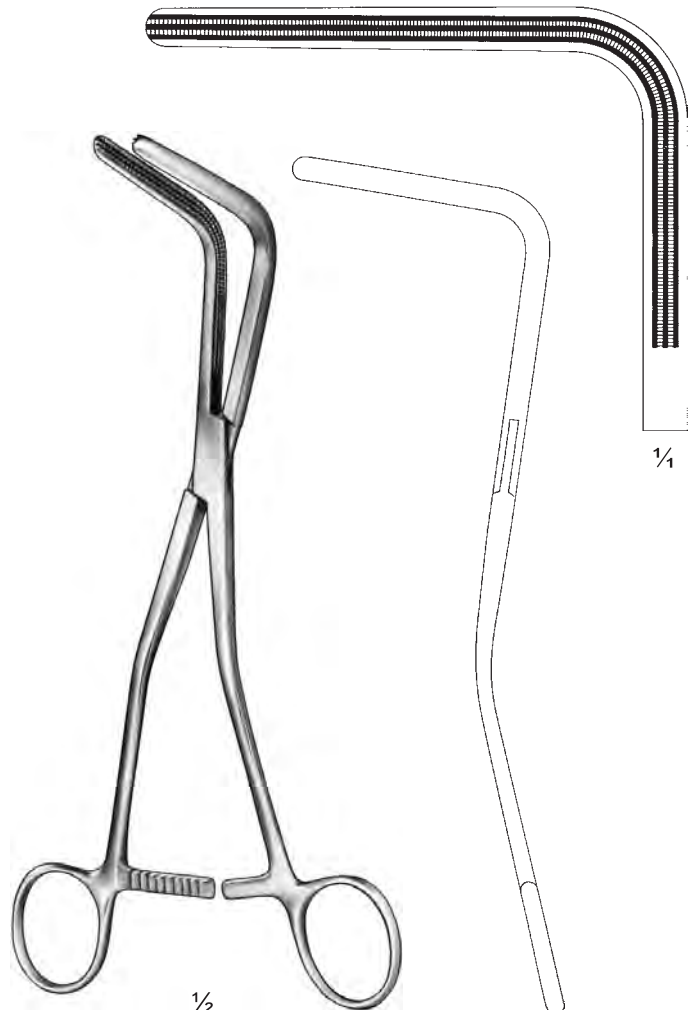

$\frac{1}{2}$
Veidenheimer
791-02-23
23 cm / 9"



Resano
792-01-27
27 cm / 10½"

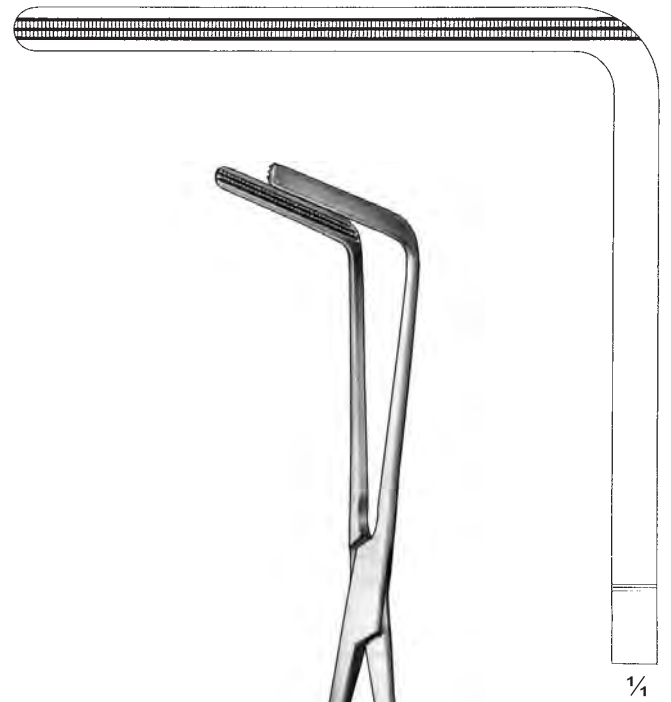

Fehland
792-02-24
24 cm / 9½"

**Anastomosenklemmen
Anastomosis Clamps
Pincettes-clamps à anastomose**

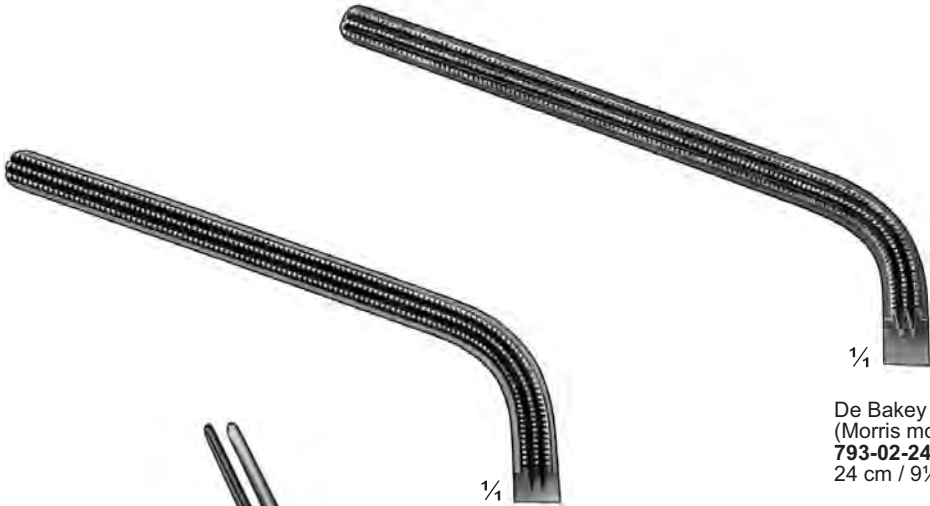

De Bakey
(Morris modif.)
793-02-24
24 cm / 9½"

Morris
793-01-18
18 cm / 7"



793-01-18 & 793-02-24

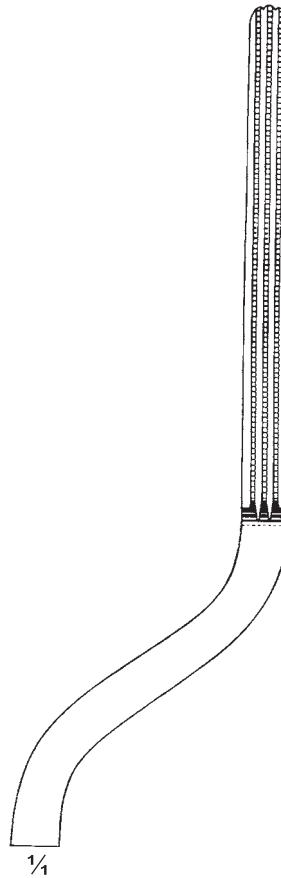

1/4



Brunner
793-03-24
24 cm / 9½"



794-01-07
7 cm / 2¾"



794-02-08
8.5 cm / 3¼"



Keresting
794-01-07 & 794-02-08

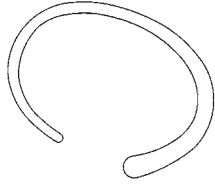

Becker
794-03-33
33.5 cm / 13¼"
Oesophagus
dissector
Small

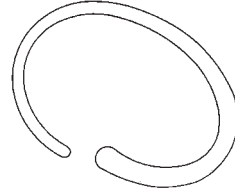

Becker
794-04-33
33.5 cm / 13¼"
Oesophagus
dissector
Medium

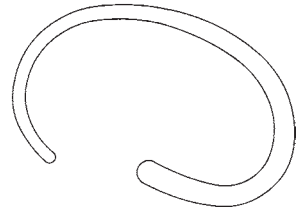

Becker
794-05-33
33.5 cm / 13¼"
Oesophagus
dissector
Large



25 X 115 mm

Czerny
795-01-22
22 cm / 8³/₄"



12/20 X 70 mm

Ricord
795-02-16
16 cm / 6¹/₄"



15/30 X 70 mm

1/2
Roschke
795-03-18
18 cm / 7"



90 X 15 mm

1/2
Mathieu
795-04-19
19.5 cm / 7³/₄"

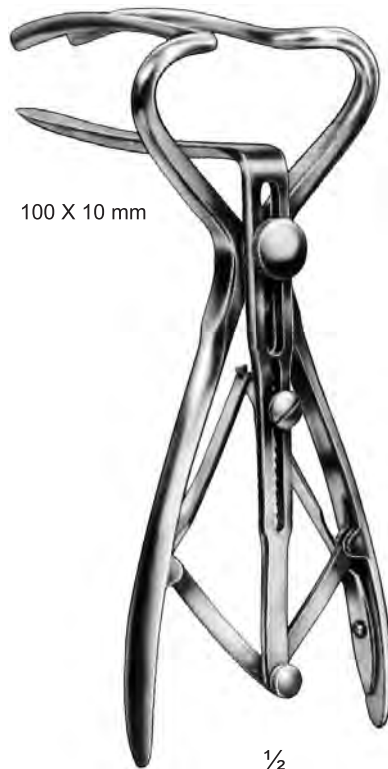

100 X 10 mm

1/2
Cook
795-05-19
19 cm / 7¹/₂"

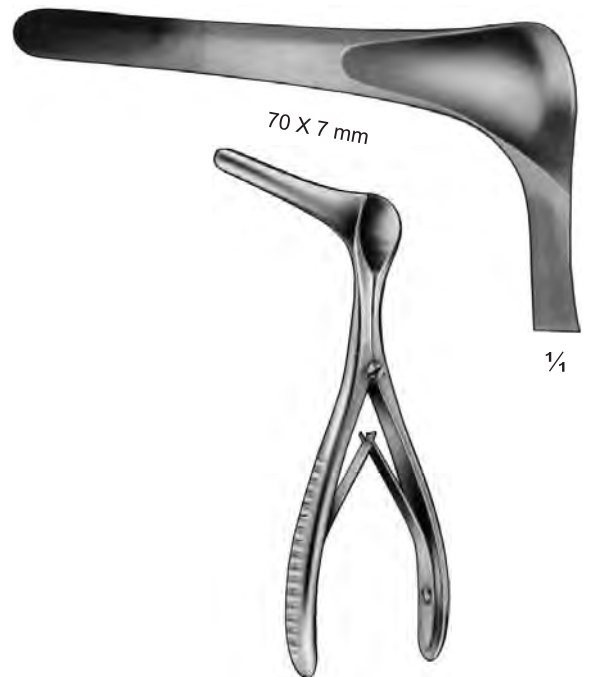

70 X 7 mm

1/4
Killian
795-06-14
14.5 cm / 5³/₄"
For children

**Mastdarmspekula
Rectal Specula
Spéculums rectaux**



Schulze-Bergmann
796-01-19 To 796-04-24



20 X 60 mm

1/2
796-01-19
796-05-19
19 cm / 7 1/2"
For children

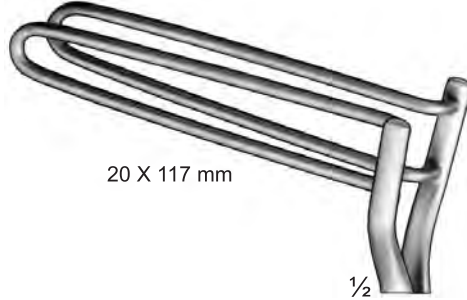

20 X 117 mm

1/2
796-03-23
796-07-23
23.5 cm / 9 1/4"
For adult



Sims
796-05-19 To 796-08-24

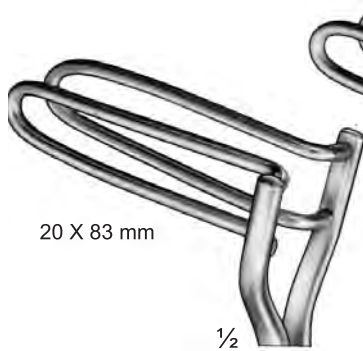

20 X 83 mm

1/2
796-02-23
796-06-23
23.5 cm / 9 1/4"
For adult

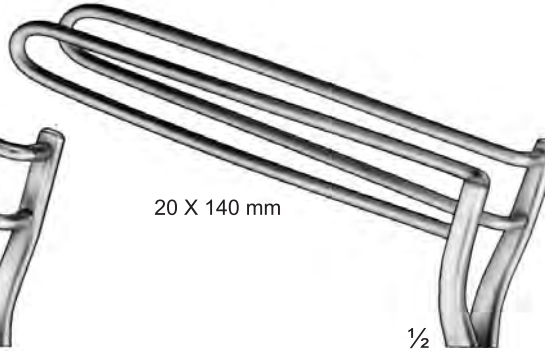

20 X 140 mm

1/2
796-04-24
796-08-24
24.5 cm / 9 3/4"
For adult



17 X 77 mm

Sims
796-09-16
16 cm / 6 1/4"



17 X 77 mm

Sims
796-10-16
16 cm / 6 1/4"



25 X 80 mm

1/2

**Pratt
797-01-20**
20 cm / 8"

22 X 70 mm

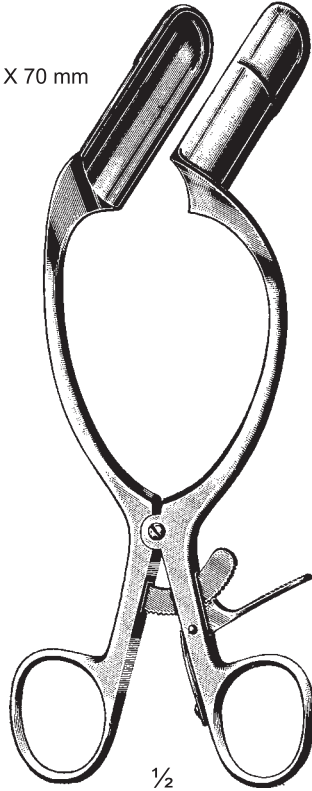

1/2

**Barr
797-02-17**
17 cm / 6 3/4"



**Barr
797-03-13**
13.5 cm / 5 1/4"
With 2 pairs of blades

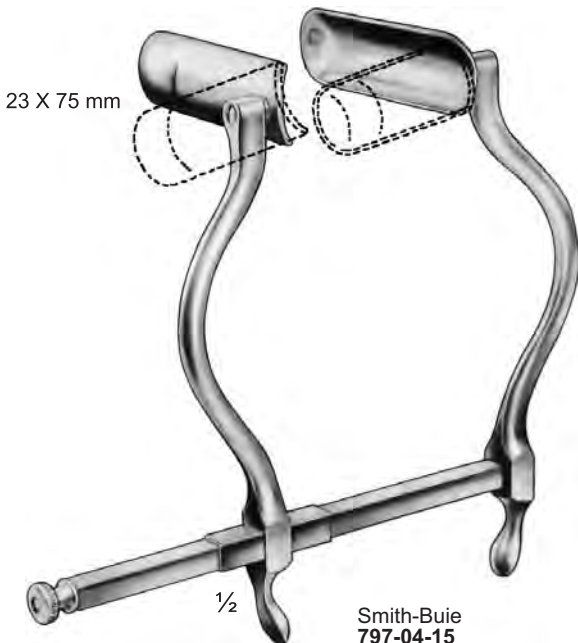

23 X 75 mm

1/2

**Smith-Buie
797-04-15**
15 cm / 6"

22 X 72 mm

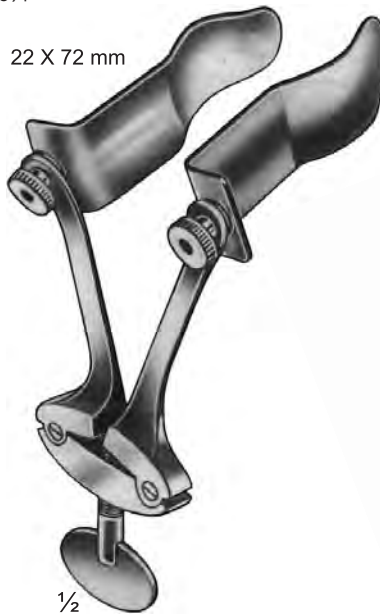

1/2

**Park
797-05-16**
16 cm / 6 1/4"



**Brinkerhoff
797-06-90** Ø 13/25 X 90 mm
797-07-100 Ø 15/25 X 100 mm
797-08-115 Ø 19/32 X 115 mm



$\frac{1}{2}$
Ives-Fransler
798-01-14
14.5 cm / 5 $\frac{3}{4}$ "

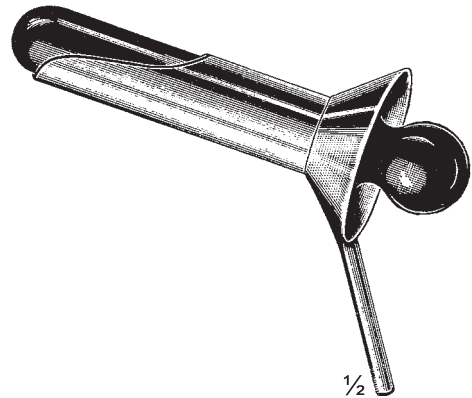

$\frac{1}{2}$
Ives-Fransler
798-02-00



Hirschmann
798-03-16 Ø 16 X 60 mm
798-04-19 Ø 19 X 70 mm
798-05-22 Ø 22 X 90 mm



$\frac{1}{2}$
Bensaude
798-06-17 Ø 17 mm
798-07-20 Ø 20 mm
798-08-23 Ø 23 mm
19 cm / 7 $\frac{1}{2}$ "



$\frac{1}{2}$
Newman
798-09-16 Ø 16 X 63 mm
798-10-19 Ø 19 X 63 mm
798-11-23 Ø 23 X 63 mm

**Mastdarmspekula
Rectal Specula
Spéculums rectaux**

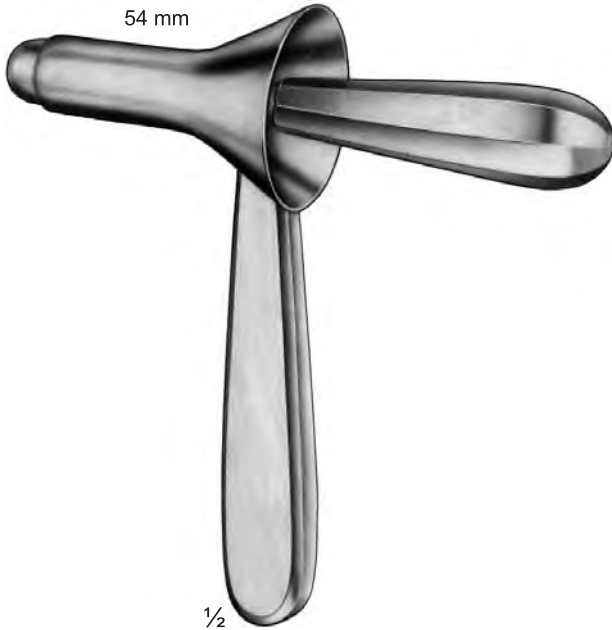

54 mm
1/2
Kelly
799-01-21
16 cm / 6 1/4"
Ø 21 X 54 mm



50 mm
1/2
Kelly
799-02-22 Ø 22 X 50 mm
799-03-22 Ø 22 X 100 mm
799-04-22 Ø 22 X 140 mm

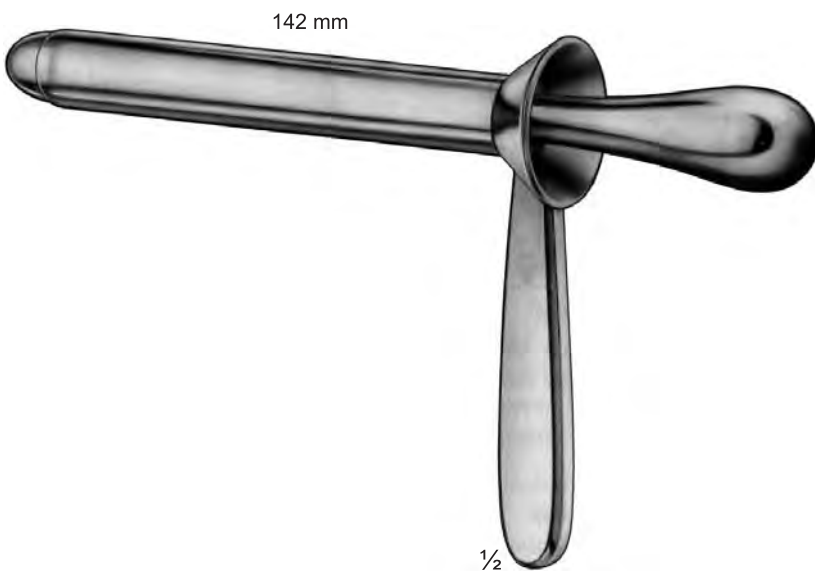

142 mm
1/2
Kelly
799-05-27 Ø 27 X 142 mm
799-06-27 Ø 27 X 205 mm
14 cm / 5 1/2"

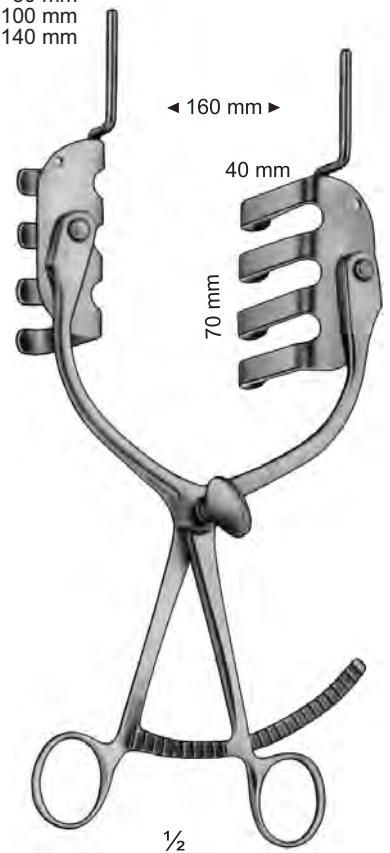

160 mm
40 mm
70 mm
1/2
St. Marks,
Modif. Girona
799-07-00
Perineal retractor with towel
pegs fitted to swivel rake blades

Hämorrhoidenfasszange
Hemorrhoidal Grasping Forceps
Pince pour hémorroïdes

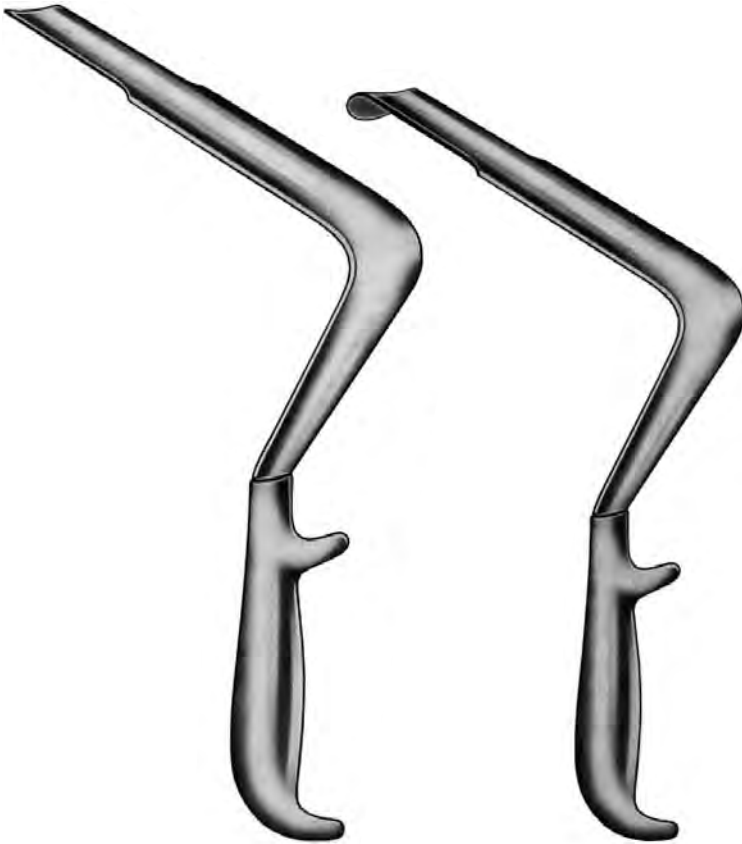

Lloyd-Davis (St. Marks)
800-01-60 60 X 130 mm
800-02-60 60 X 180 mm
 33 cm / 13"

Lloyd-Davis (St. Marks)
800-03-60 60 X 130 mm
800-04-60 60 X 180 mm
 30 cm / 12"



$\frac{1}{2}$
 Mc Givney
800-05-18
 18.5 cm / 7 $\frac{1}{4}$ "

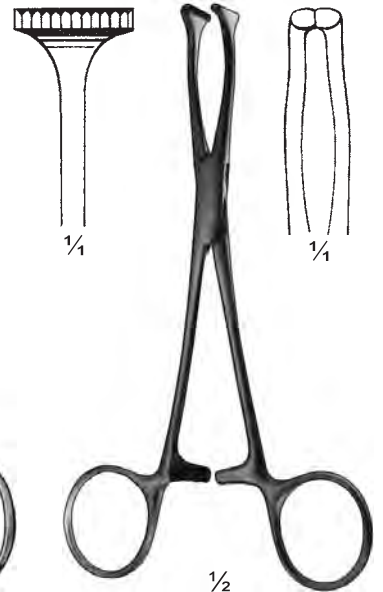

$\frac{1}{2}$
 Pratt-Smith
800-06-16
 16 cm / 6 $\frac{1}{4}$ "

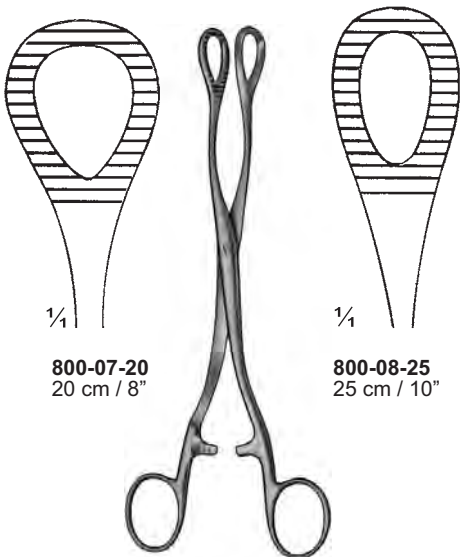

$\frac{1}{4}$
800-07-20
 20 cm / 8"

$\frac{1}{4}$
800-08-25
 25 cm / 10"

Heywood-Smith
800-07-20 & 800-08-25

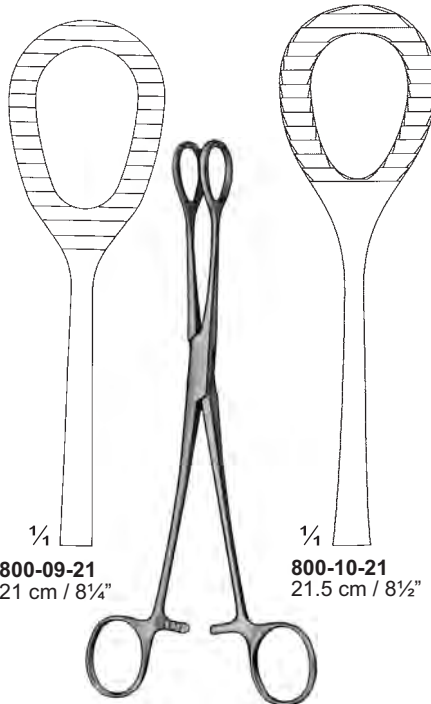

$\frac{1}{4}$
800-09-21
 21 cm / 8 $\frac{1}{4}$ "

$\frac{1}{4}$
800-10-21
 21.5 cm / 8 $\frac{1}{2}$ "

Heywood-Smith modif.
800-09-21 & 800-10-21

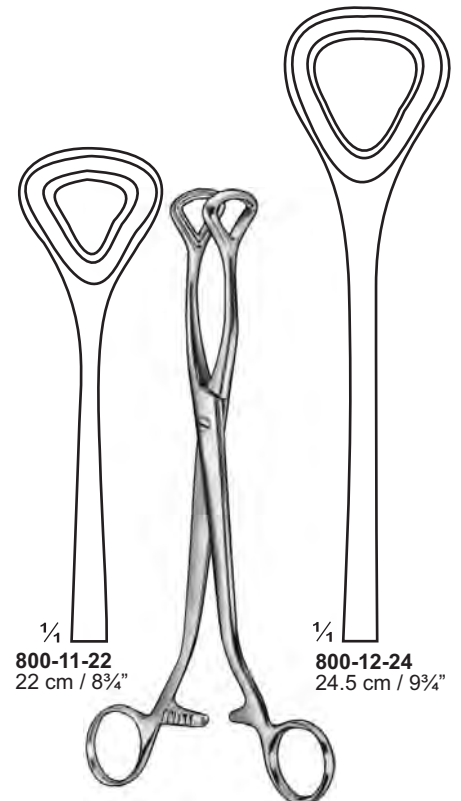

$\frac{1}{4}$
800-11-22
 22 cm / 8 $\frac{3}{4}$ "

$\frac{1}{4}$
800-12-24
 24.5 cm / 9 $\frac{3}{4}$ "

Luer
800-11-22 & 800-12-24

Hämorrhoidenfasszange
 Hemorrhoidal Grasping Forceps
 Pince pour hémorroïdes

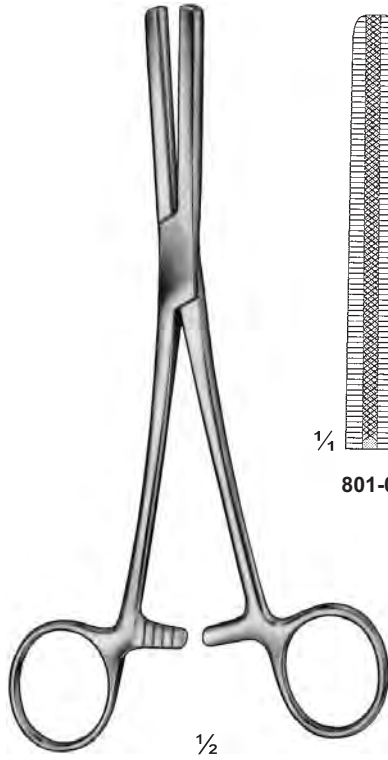

Fergusson
 801-01-20 & 801-02-20
 20 cm / 8"

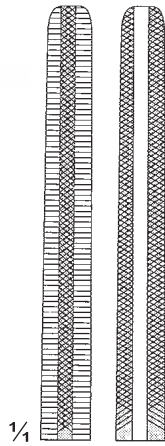

801-01-20

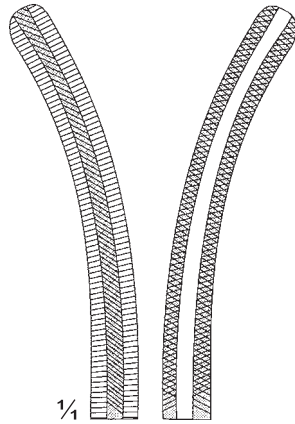

801-02-20

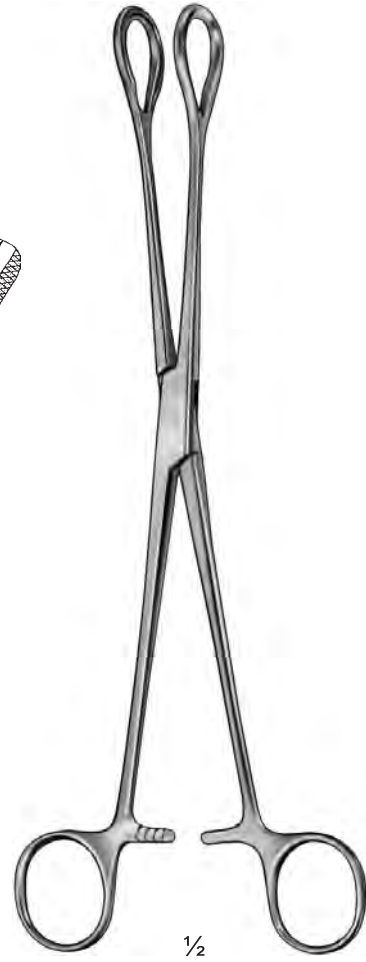

801-03-25 & 801-04-26



801-03-25
 25 cm / 10"



801-04-26
 26 cm / 10 1/4"



801-05-25 25 cm / 10" 801-07-25
 801-06-30 30 cm / 12" 801-08-30



Lloyd-Davies (Goligher's)
 801-05-25 To 801-08-30

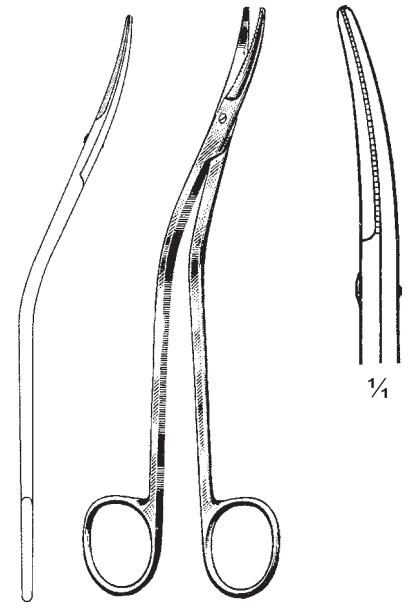

Miller
 801-09-17
 17 cm / 6 3/4"

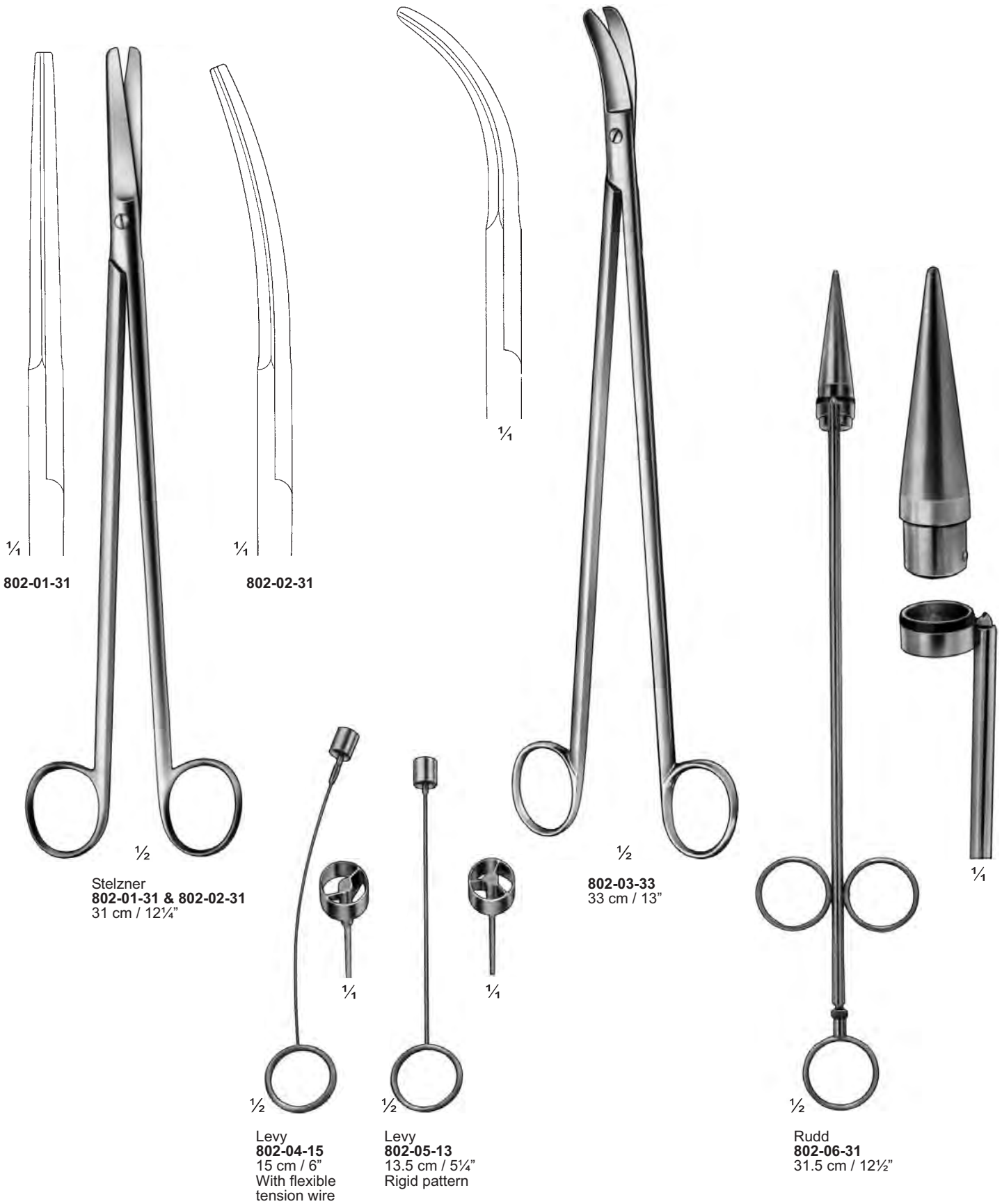

Darmscheren, Hämorrhoidal-Ligator
Enterotomy Scissors, Hemorrhoidal Ligator
Ciseaux-entérotomes, Ligateur pour hémorroïdes



McGivney modif.
803-01-00

803-02-00 Lockhart-Mummery
803-03-16 To 803-06-16
16.5 cm / 6½"

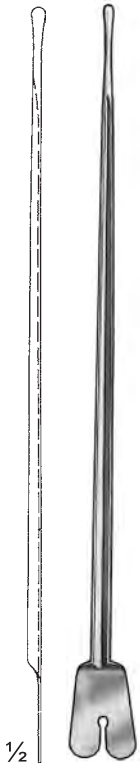
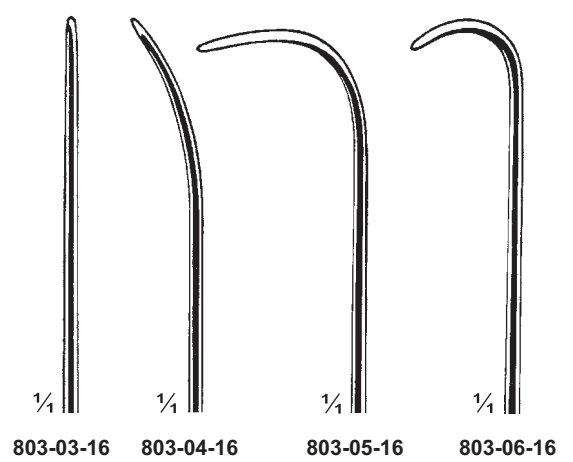

Brodie
803-07-20
20 cm / 8"



¼



803-08-19
19 cm / 7½"



¼



803-09-19
19 cm / 7½"
Malleable



Pratt
803-10-20
20 cm / 8"



Buie
803-11-16
16 cm / 6¼"

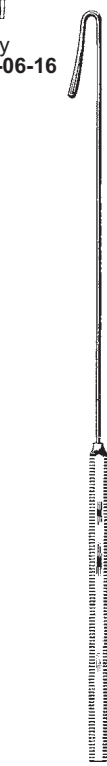

Pratt
803-12-24 To 803-15-24
24 cm / 9½"



¼
803-12-24
803-16-24



¼
803-13-24
803-17-24



¼
803-14-24
803-18-24



¼
803-15-24
803-19-24



½

803-16-24 To 803-19-24
24 cm / 9½"

Rektum-Biopsiefasszangen
Rectal Biopsy Forceps
Pinces pour biopsie rectale



1/2

Yeoman
804-01-28 To 804-12-42

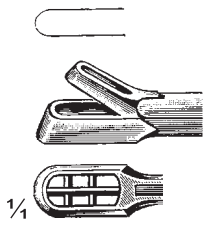

Shaft length
804-01-28 28 cm / 11"
804-02-35 35 cm / 13 3/4"
804-03-42 42 cm / 16 1/2"

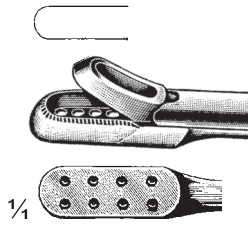

Shaft length
804-04-28 28 cm / 11"
804-05-35 35 cm / 13 3/4"
804-06-42 42 cm / 16 1/2"

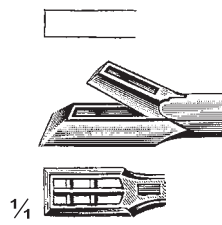

Shaft length
804-07-28 28 cm / 11"
804-08-35 35 cm / 13 3/4"
804-09-42 42 cm / 16 1/2"

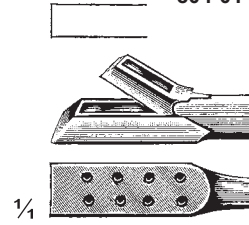

Shaft length
804-10-28 28 cm / 11"
804-11-35 35 cm / 13 3/4"
804-12-42 42 cm / 16 1/2"

38.5 cm / 15 1/2"

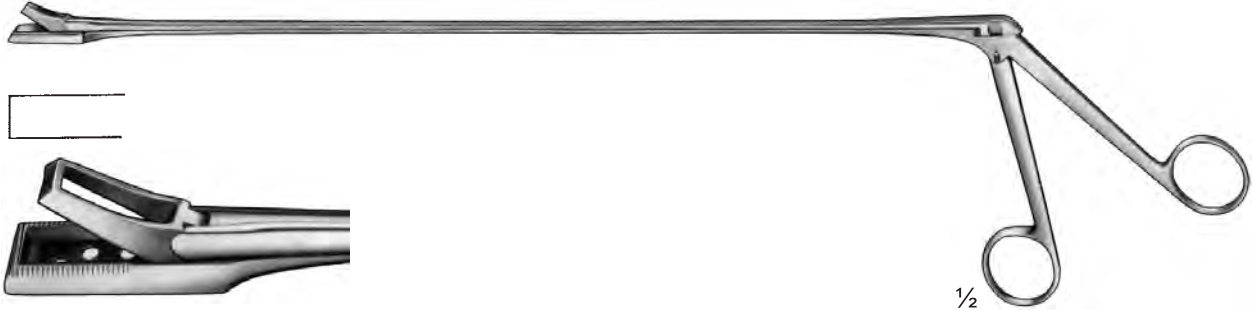

1/2

804-13-38
 Shaft length 38.5 cm / 15 1/2"

38 cm / 15 1/8"

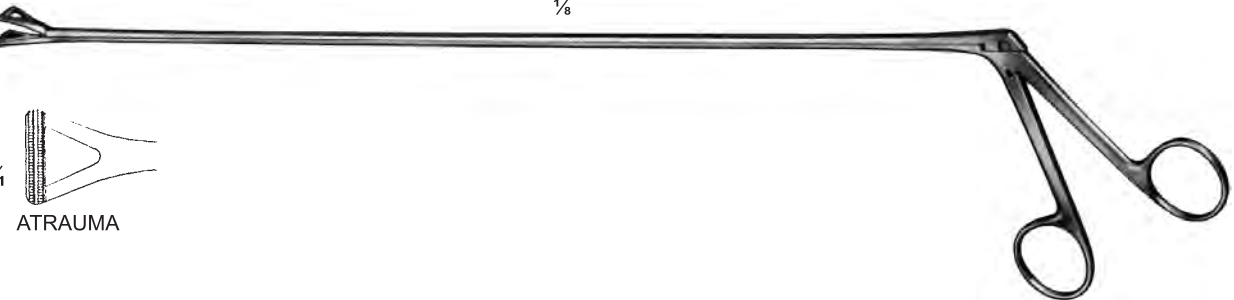

1/4



ATRAUMA

804-14-38
 Shaft length 38 cm / 15 1/8"

Rektum-Biopsiefasszangen
Rectal Biopsy Forceps
Pinces pour biopsie rectale

35 cm / 13 1/4"

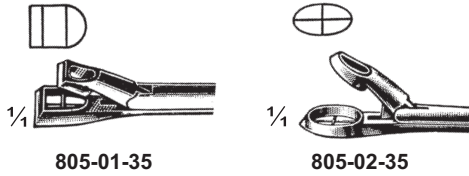

805-01-35

805-02-35

Jackson
805-01-35 & 805-02-35
 Shaft length 35 cm / 13 1/4"

38 cm / 15 1/8"



1/8

Herget
805-03-38
 Shaft length 38 cm / 15 1/8"

42 cm / 16 3/4"

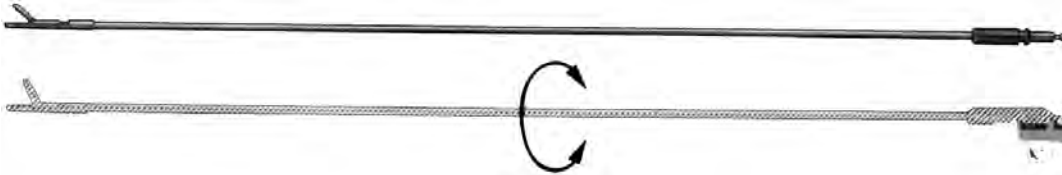

1/2

Herget
805-04-42 To 805-09-42
 Shaft length 42 cm / 16 3/4"

42 cm / 16 3/4"

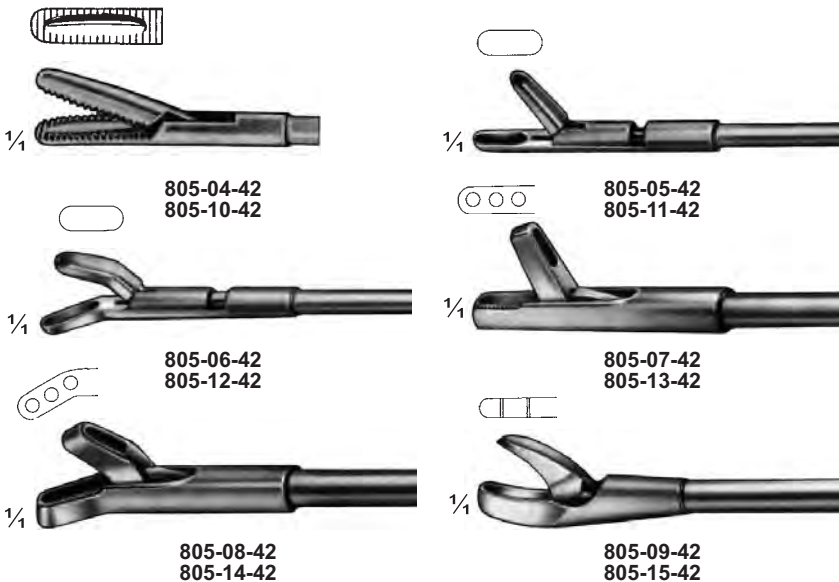

805-04-42
 805-10-42

805-05-42
 805-11-42

805-10-42 To 805-15-42
 Shaft length 42 cm / 16 3/4"

805-06-42
 805-12-42

805-07-42
 805-13-42

805-08-42
 805-14-42

805-09-42
 805-15-42

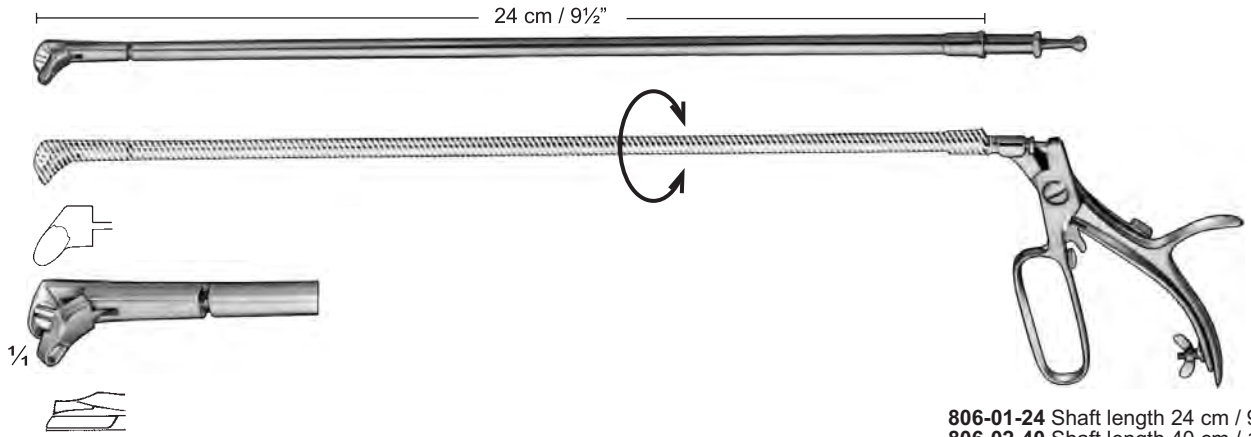

806-01-24 Shaft length 24 cm / 9½"
806-02-40 Shaft length 40 cm / 16"

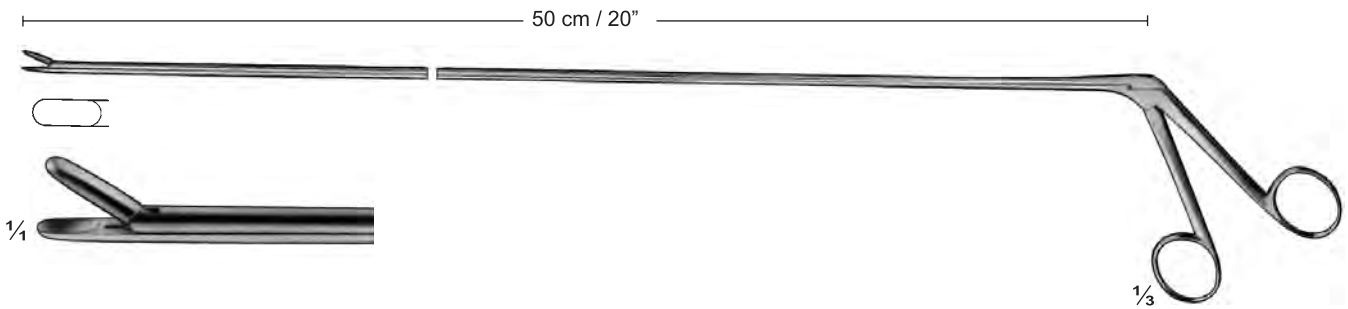

806-03-35 Shaft length 35 cm / 14"
806-04-50 Shaft length 50 cm / 20"

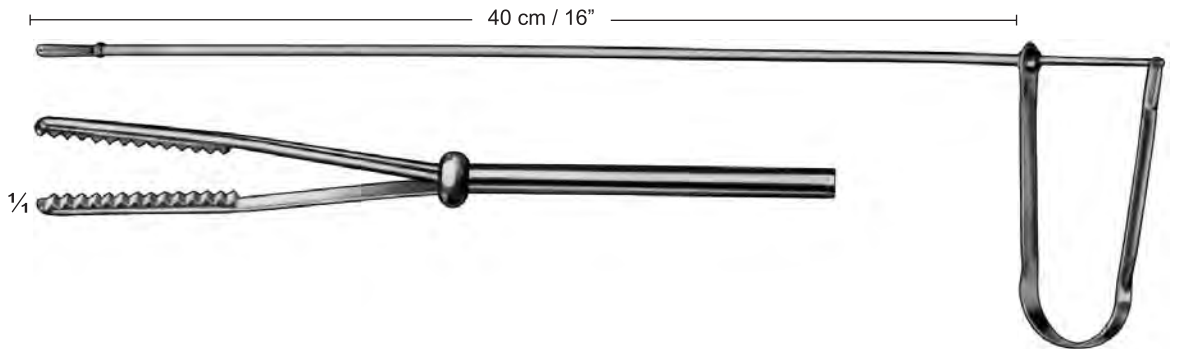

806-05-40
 Shaft length 40 cm / 16"

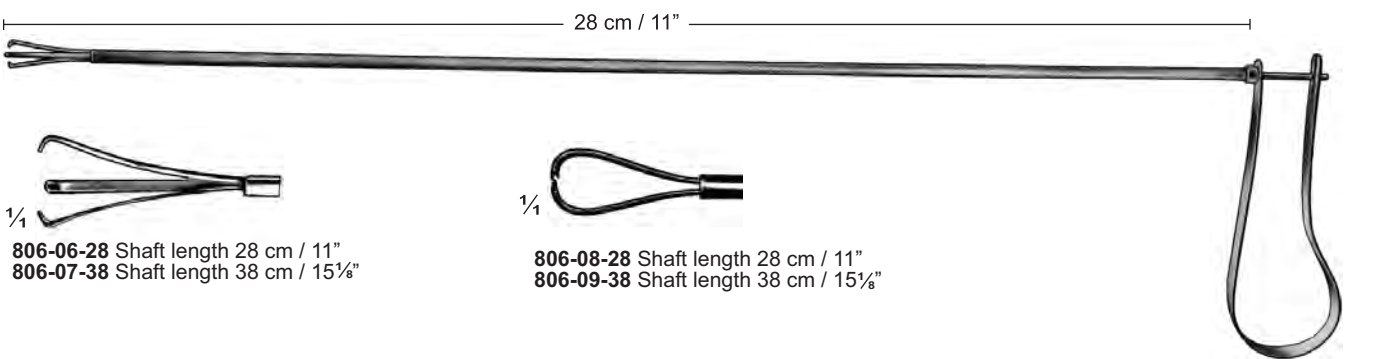

806-06-28 Shaft length 28 cm / 11"
806-07-38 Shaft length 38 cm / 15¼"

806-08-28 Shaft length 28 cm / 11"
806-09-38 Shaft length 38 cm / 15½"

806-06-28 To 806-09

Rektum-Biopsiefasszangen
Rectal Biopsy Forceps
Pinces pour biopsie rectale



807-01-36
 36 cm / 14 1/4"



807-02-25 25 cm / 10"
807-03-35 35 cm / 14"
807-04-40 40 cm / 16"
807-05-50 50 cm / 20"

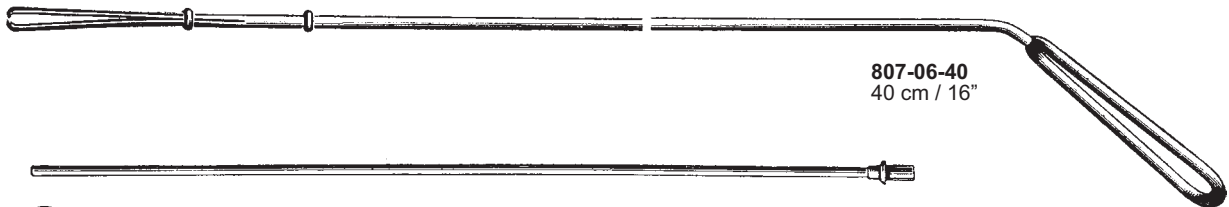

807-06-40
 40 cm / 16"

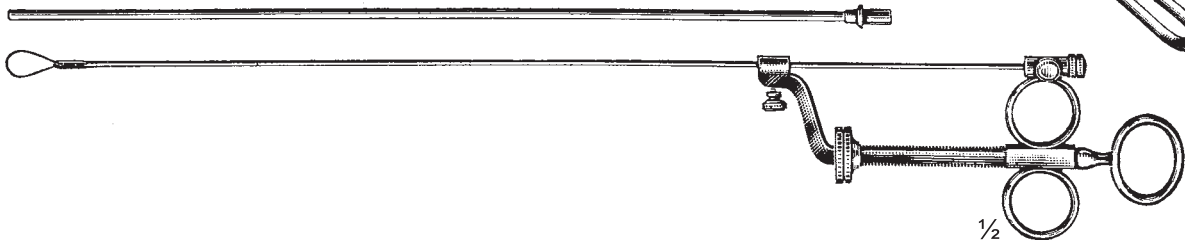

1/2

Norwood
807-07-30
 30 cm / 12"



1/2

Norwood
807-08-30 30 cm / 12"
807-09-40 40 cm / 16"



Buie
807-10-40
 40 cm / 16", Ch. 10

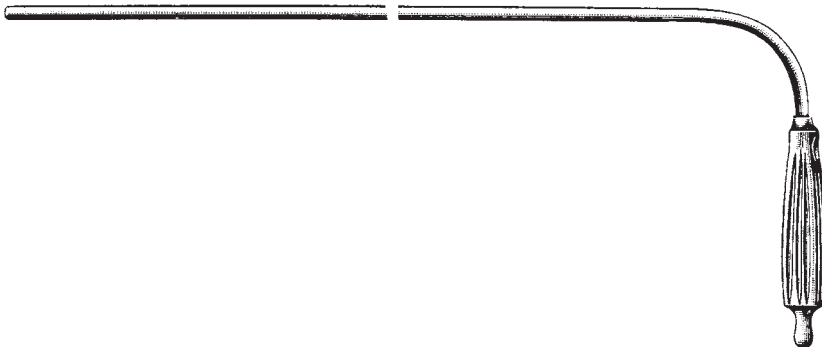

Brand
807-11-30 30 cm / 12", Ø 4 mm
807-12-40 40 cm / 16", Ø 6 mm



1/2

Katzenstein
807-13-09
 9 cm / 3 1/2"

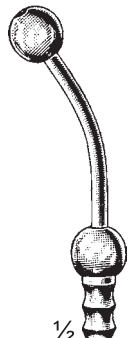

1/2

Katzenstein
807-09
 9 cm / 3 1/2"

**Lungenfasszangen, Bulldogklemmen
Lung Grasping Forceps, Bulldog Clamps
Pince-clamps au poumon, Clamps Bulldog**

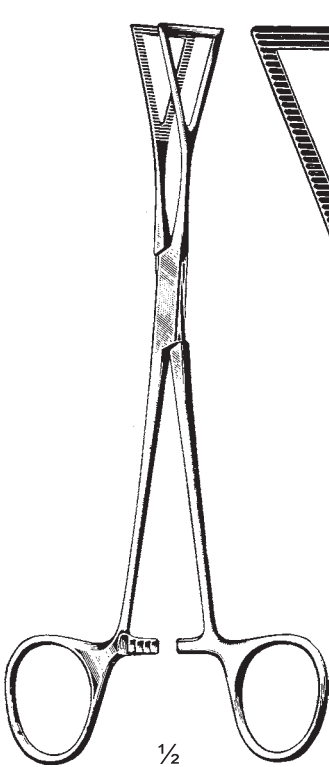

$\frac{1}{2}$
Lovelace
808-01-20
20 cm / 8"

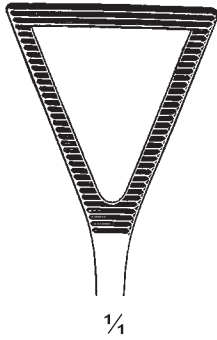

$\frac{1}{4}$

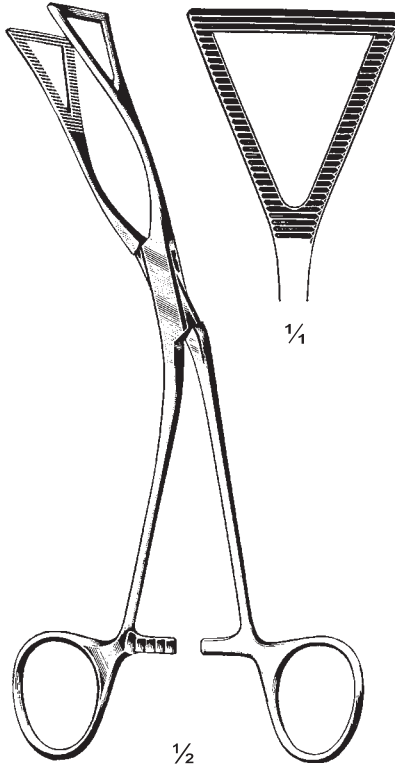

$\frac{1}{2}$
Lovelace
808-02-20
20 cm / 8"



$\frac{1}{4}$

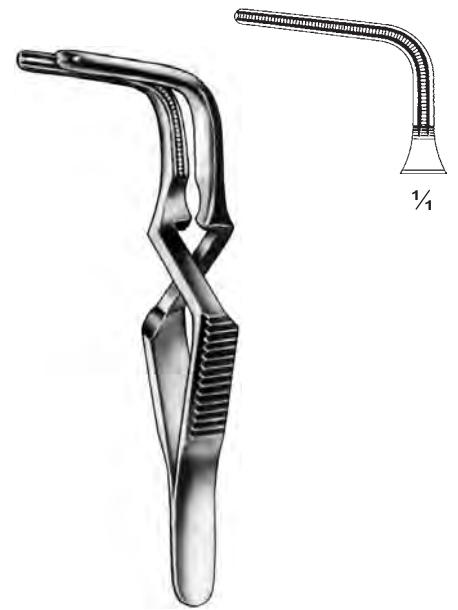

Santulli
808-03-07
7 cm / 2 $\frac{3}{4}$ "

$\frac{1}{4}$

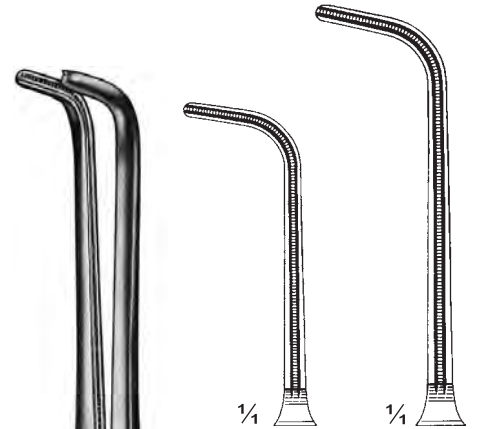

$\frac{1}{4}$
808-13-09
9 cm / 3 $\frac{1}{2}$ "

$\frac{1}{4}$
808-14-11
11 cm / 4 $\frac{1}{4}$ "



$\frac{1}{4}$

De Bakey
809-06-07 7.5 cm / 3"
809-07-08 8.5 cm / 3 $\frac{1}{4}$ "
809-08-10 10.5 cm / 4 $\frac{1}{8}$ "
809-09-12 12 cm / 4 $\frac{3}{4}$ "



$\frac{1}{4}$

De Bakey
809-10-07 7.5 cm / 3"
809-11-08 8.5 cm / 3 $\frac{1}{4}$ "
809-12-10 10.5 cm / 4 $\frac{1}{8}$ "
809-13-12 12 cm / 4 $\frac{3}{4}$ "



Glover
808-12-05
5 cm / 2"



$\frac{1}{4}$

Gregory-Soft
808-13-09 To 808-14-11
Carotis

Bulldogklemmen, Arterienklemmen Bulldog Clamps, Haemostatic Forceps Clamps Bulldog, Pincers Hémostatiques



De Baksey-Satinsky
809-01-07
7 cm / 2 3/4"

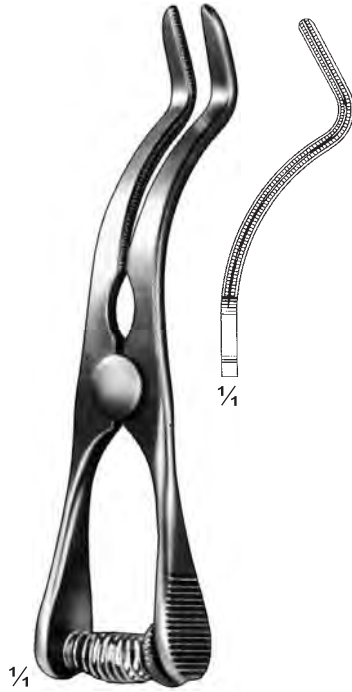

De Baksey-Carotis
809-02-09
9 cm / 3 1/2"

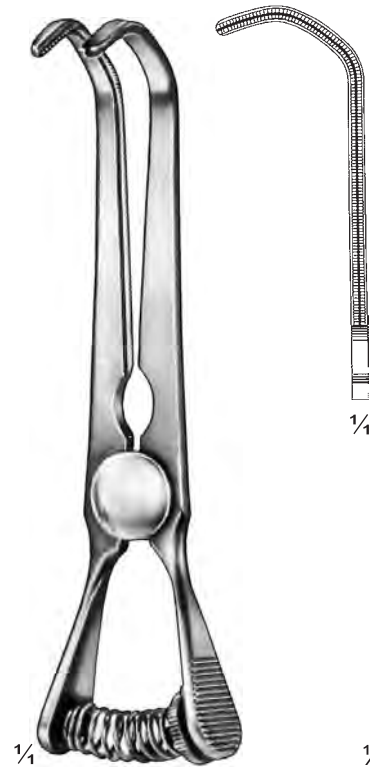

De Baksey-Satinsky
809-03-10
10 cm / 4"



De Baksey
809-04-05
5 cm / 2"



De Baksey
809-05-05
5 cm / 2"



De Baksey
809-06-07 7.5 cm / 3"
809-07-08 8.5 cm / 3 1/4"
809-08-10 10.5 cm / 4 1/8"
809-09-12 12 cm / 4 3/4"



De Baksey
809-10-07 7.5 cm / 3"
809-11-08 8.5 cm / 3 1/4"
809-12-10 10.5 cm / 4 1/8"
809-13-12 12 cm / 4 3/4"



809-14 -14To 809-17-16



De Baksey-Kelly
809-14-14
14 cm / 5 1/2"



De Baksey-Kelly
809-15-14
14 cm / 5 1/2"



De Baksey-Kelly-Rankin
809-16-16
16 cm / 6 1/4"

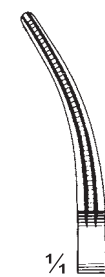

De Baksey-Kelly-Rankin
809-17-16
16 cm / 6 1/4"

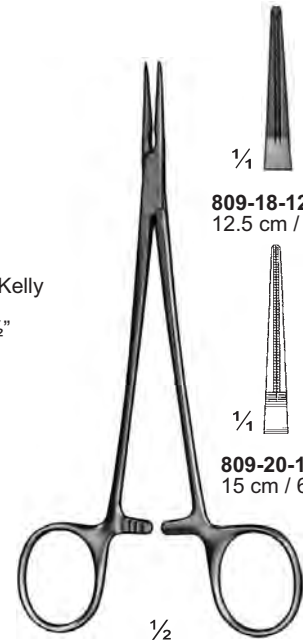

De Baksey-Mosquito
809-18-12 To 809-21-15



809-18-12
12.5 cm / 5"



809-19-12
12.5 cm / 5"



809-20-15
15 cm / 6"

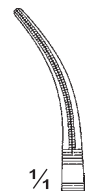

809-21-15
15 cm / 6"

**Bulldogklemmen, Arterienklemmen
Bulldog Clamps, Haemostatic Forceps
Clamps Bulldog, Pinces Hémostatiques**

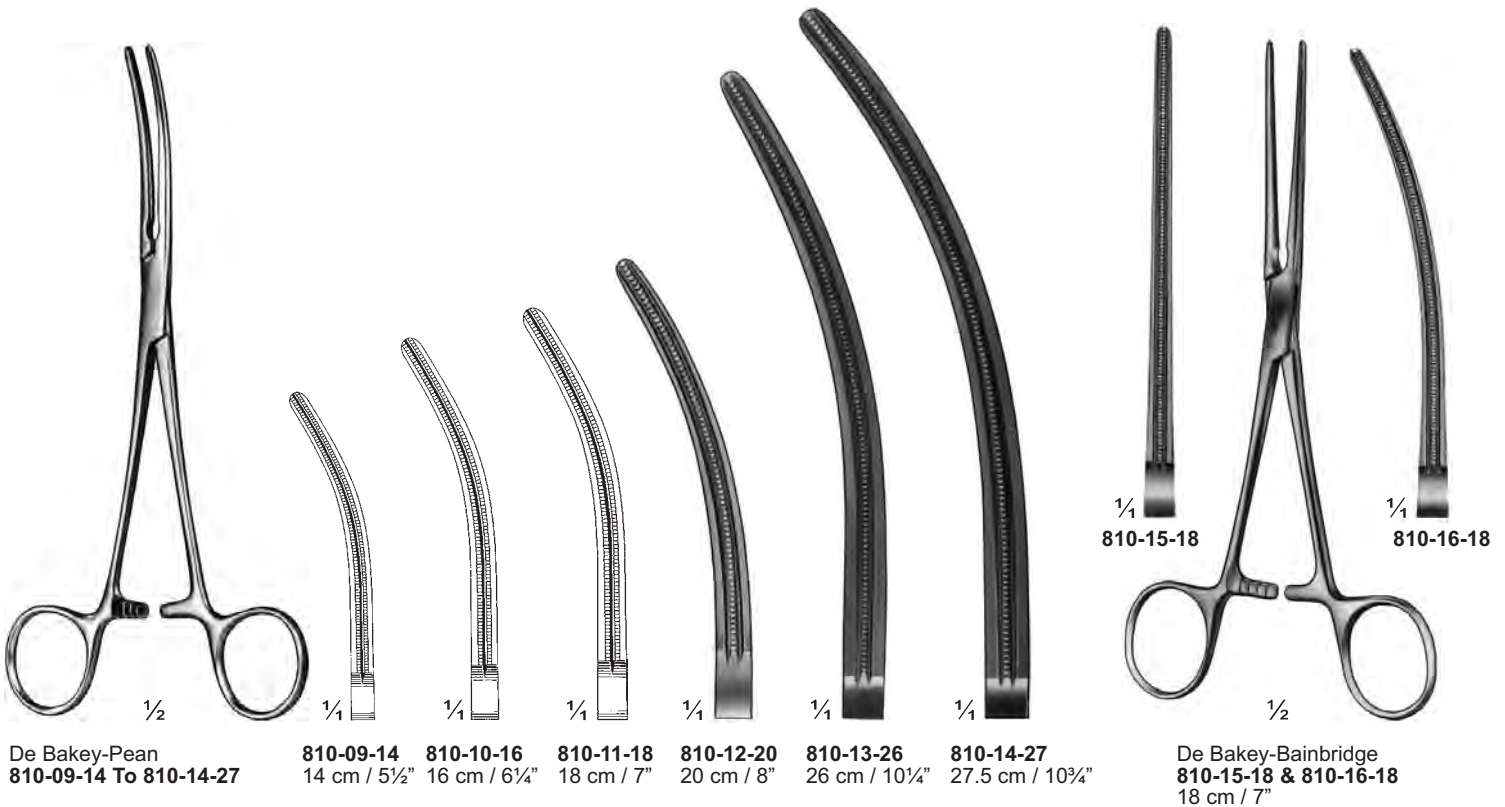
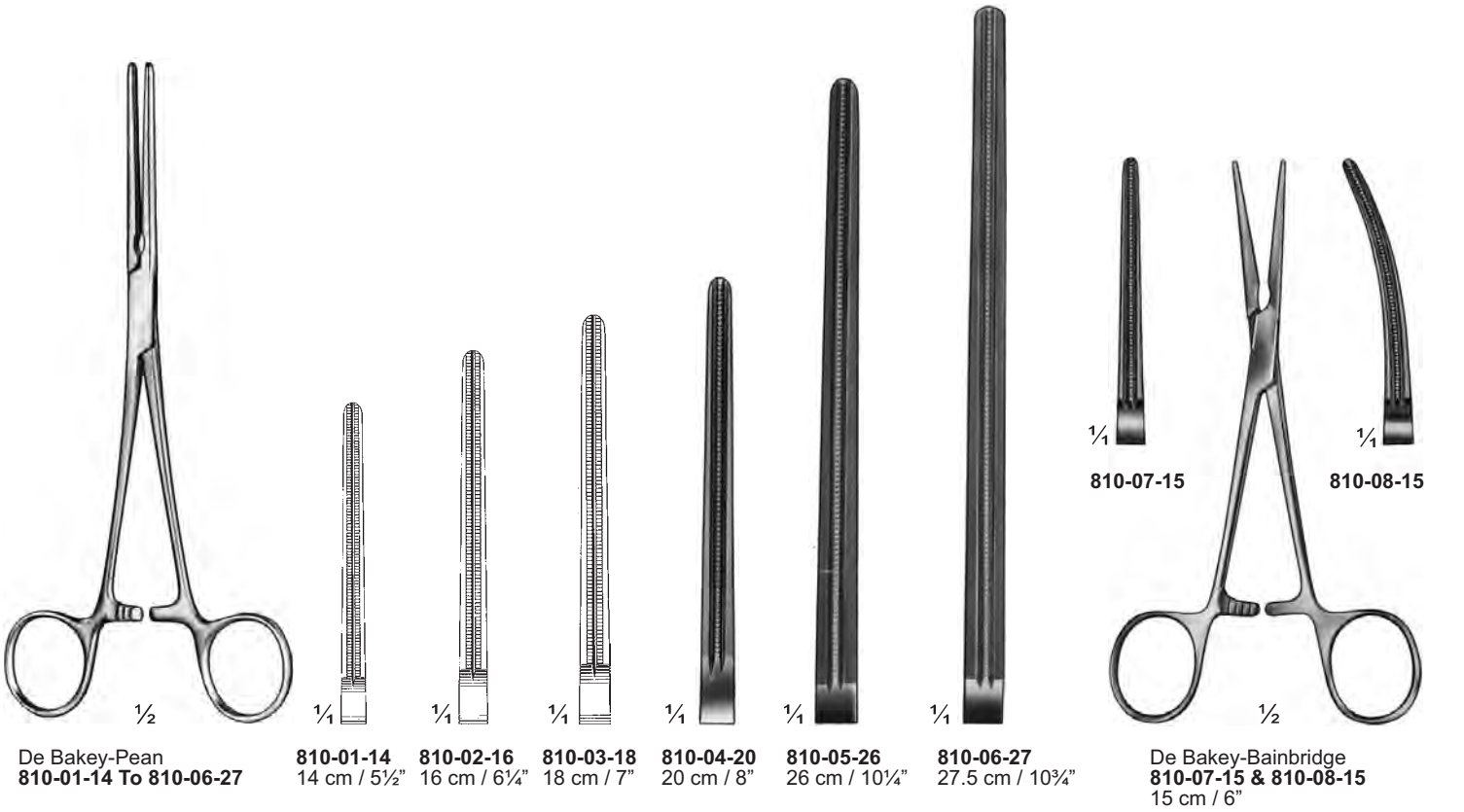

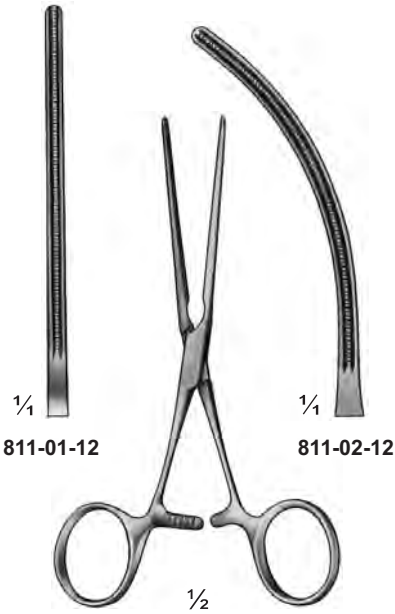

811-01-12

811-02-12

De Bakery
811-01-12 & 811-02-12
 12.5 cm / 5"

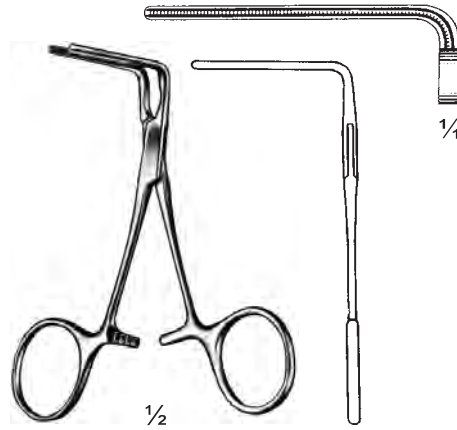

De Bakery
811-03-10
 10 cm / 4"

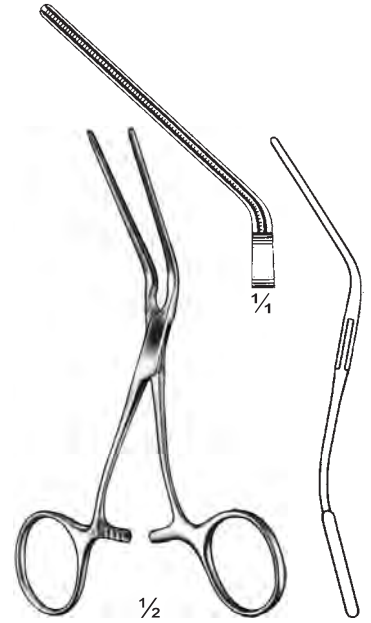

De Bakery
811-04-12
 12.5 cm / 5"

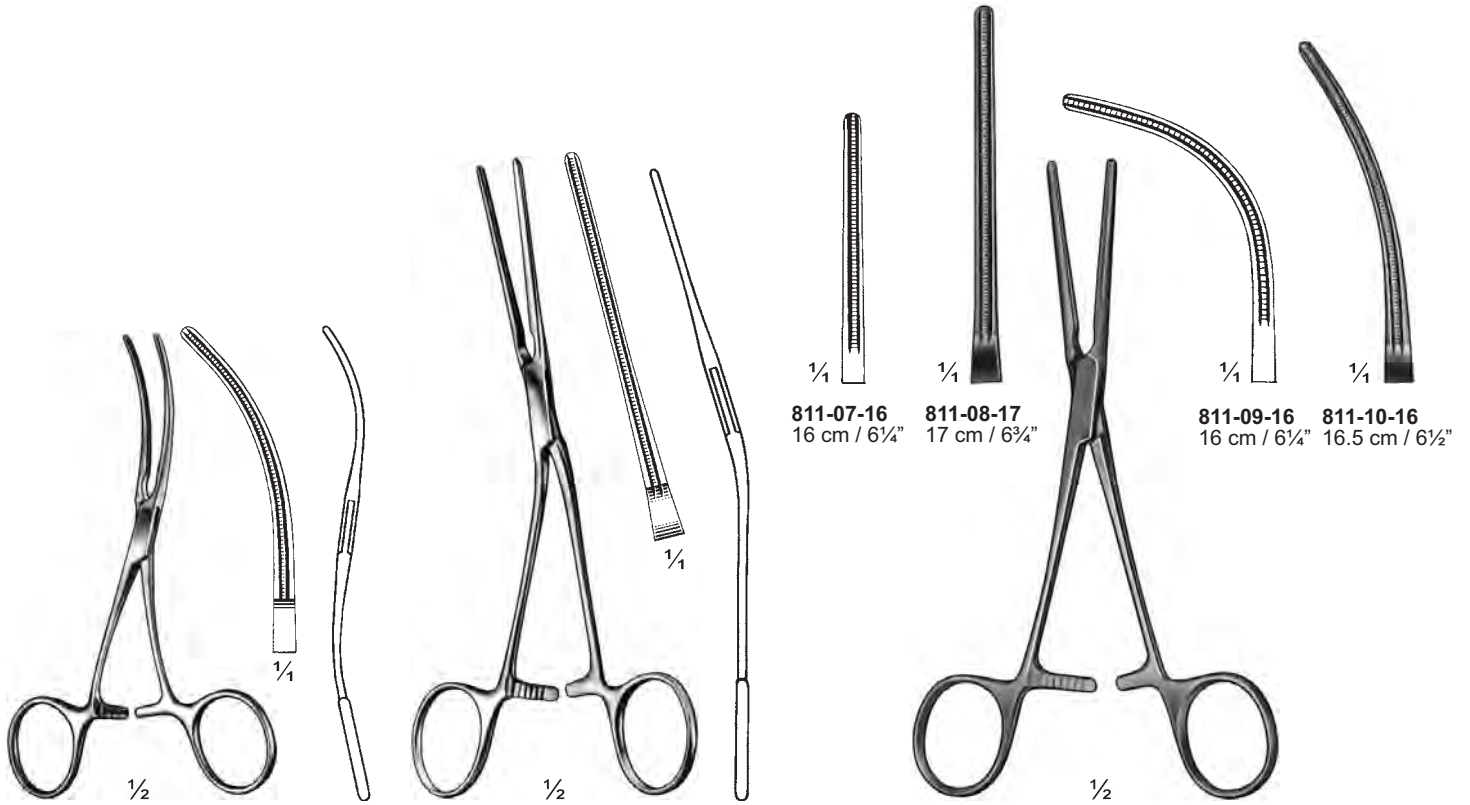

De Bakery
811-05-12
 12 cm / 4¾"

De Bakery
811-06-17
 17 cm / 6¾"

De Bakery
811-07-16 To 811-10-16

Mehrzweck-Gefäßklemmen
Atrauma Cardiovascular Forceps
Pincers vasculaires universelles

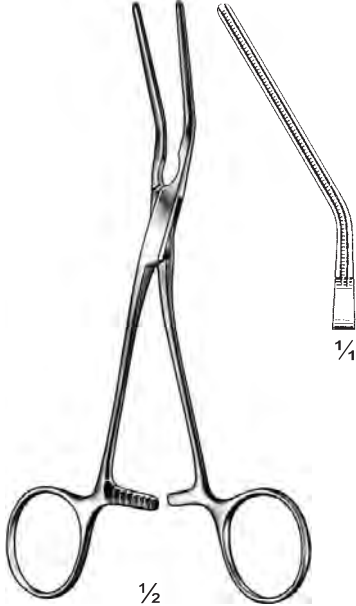

De Bakay
812-01-16
 16 cm / 6¼"

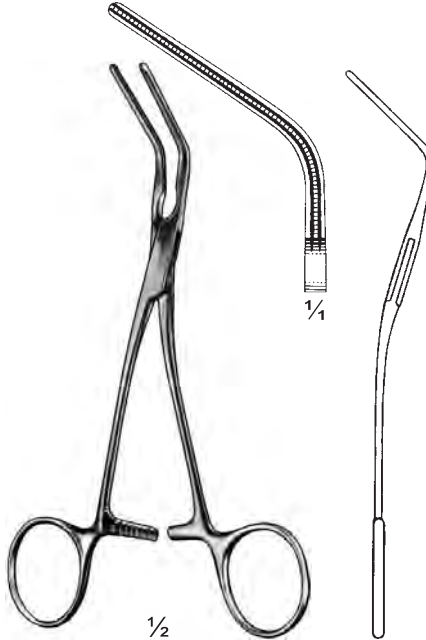

De Bakay
812-02-15
 15 cm / 6"



De Bakay
812-03-15
 15 cm / 6"

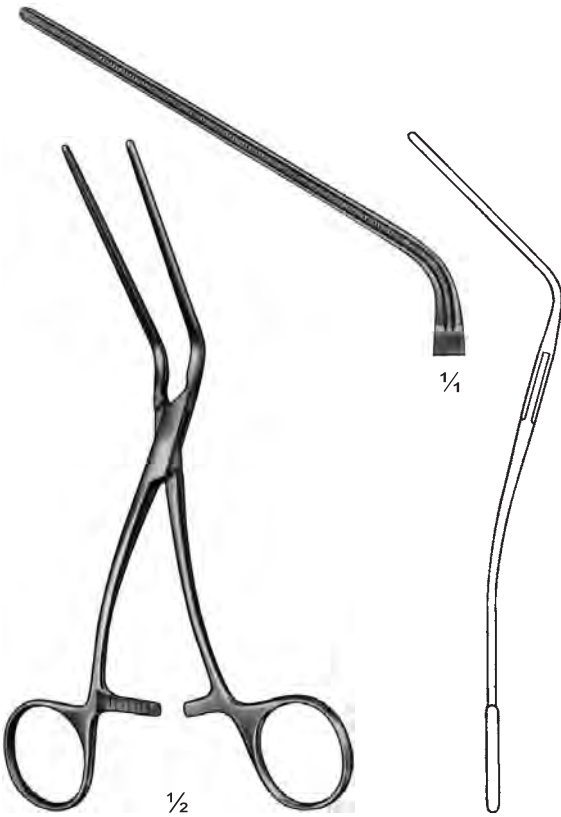

De Bakay
812-04-18
 18 cm / 7"



De Bakay
812-05-16 & 812-06-17

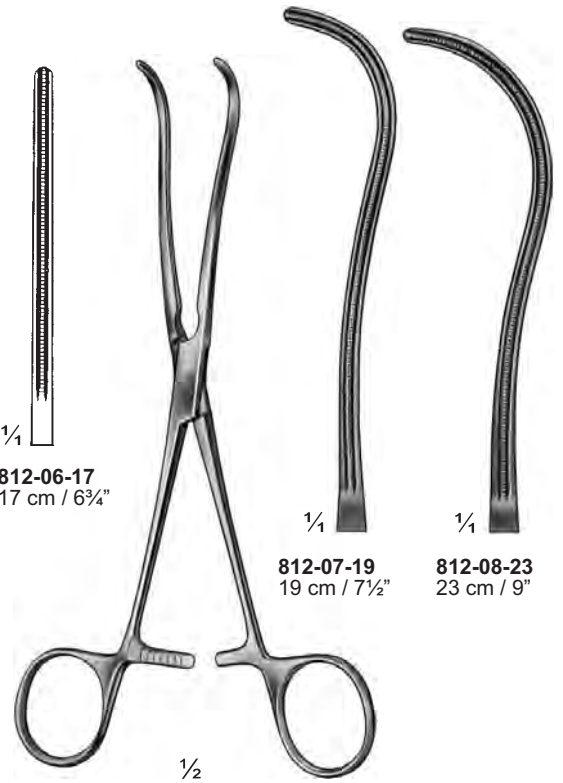

De Bakay
812-07-19 & 812-08-23

Mehrzweck-Gefäßklemmen
Atrauma Cardiovascular Forceps
Pinces vasculaires universelles



De Bakery
 813-01-21 & 813-02-23



$\frac{1}{4}$
 813-01-21
 21 cm / 8 $\frac{1}{4}$ "

$\frac{1}{4}$
 813-02-23
 23 cm / 9"



De Bakery
 813-03-23 To 813-05-25

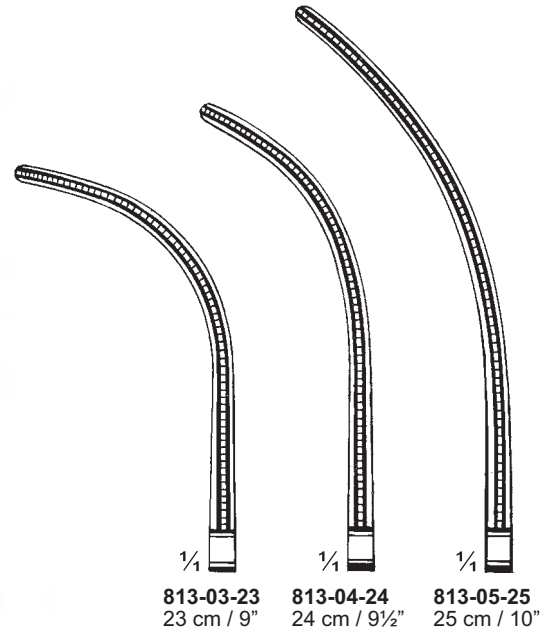

$\frac{1}{4}$
 813-03-23
 23 cm / 9"

$\frac{1}{4}$
 813-04-24
 24 cm / 9 $\frac{1}{2}$ "

$\frac{1}{4}$
 813-05-25
 25 cm / 10"



De Bakery
 813-06-18 To 813-07-20

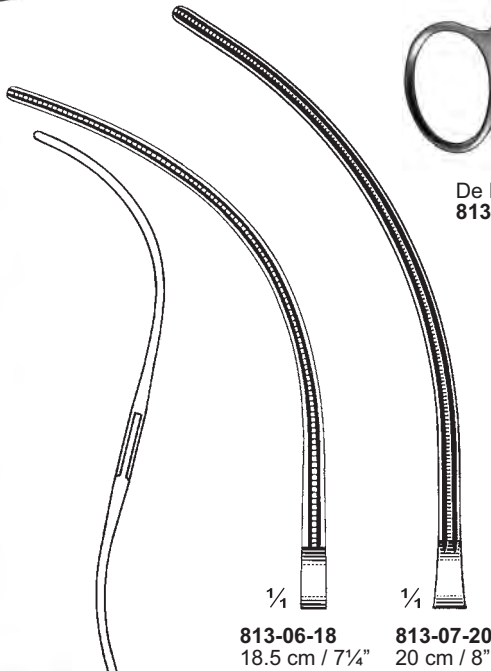

$\frac{1}{4}$
 813-06-18
 18.5 cm / 7 $\frac{1}{4}$ "

$\frac{1}{4}$
 813-07-20
 20 cm / 8"

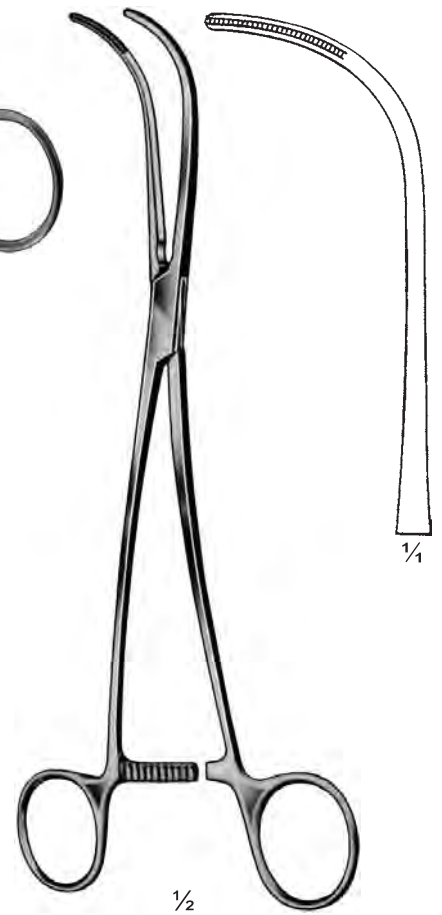

De Bakery
 813-08-24
 24 cm / 9 $\frac{1}{2}$ "

Mehrzweck-Gefäßklemmen
Atrauma Cardiovascular Forceps
Pinces vasculaires universelles



Mehrzweck-Gefäßklemmen
Atrauma Cardiovascular Forceps
Pincers vasculaires universelles

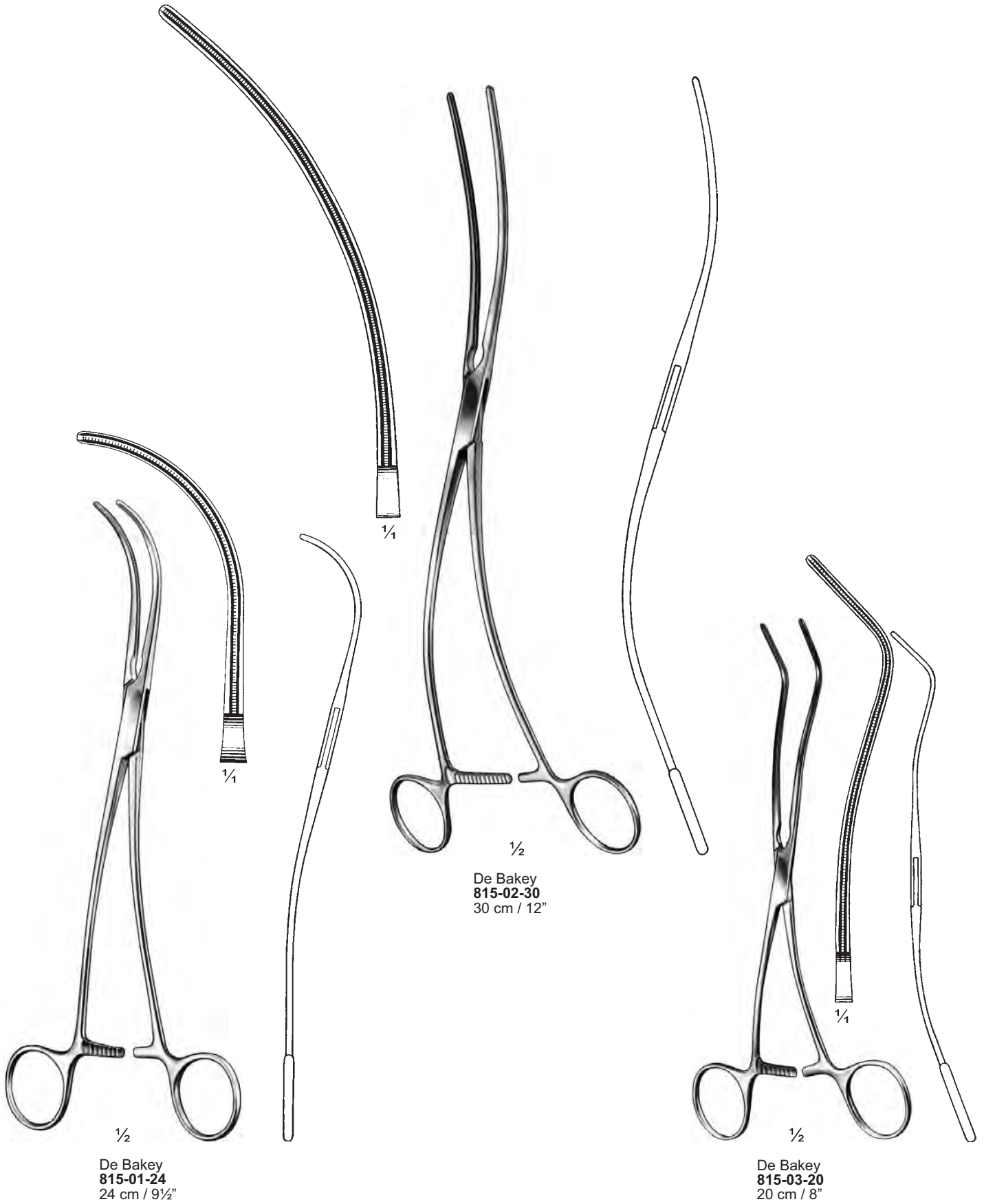

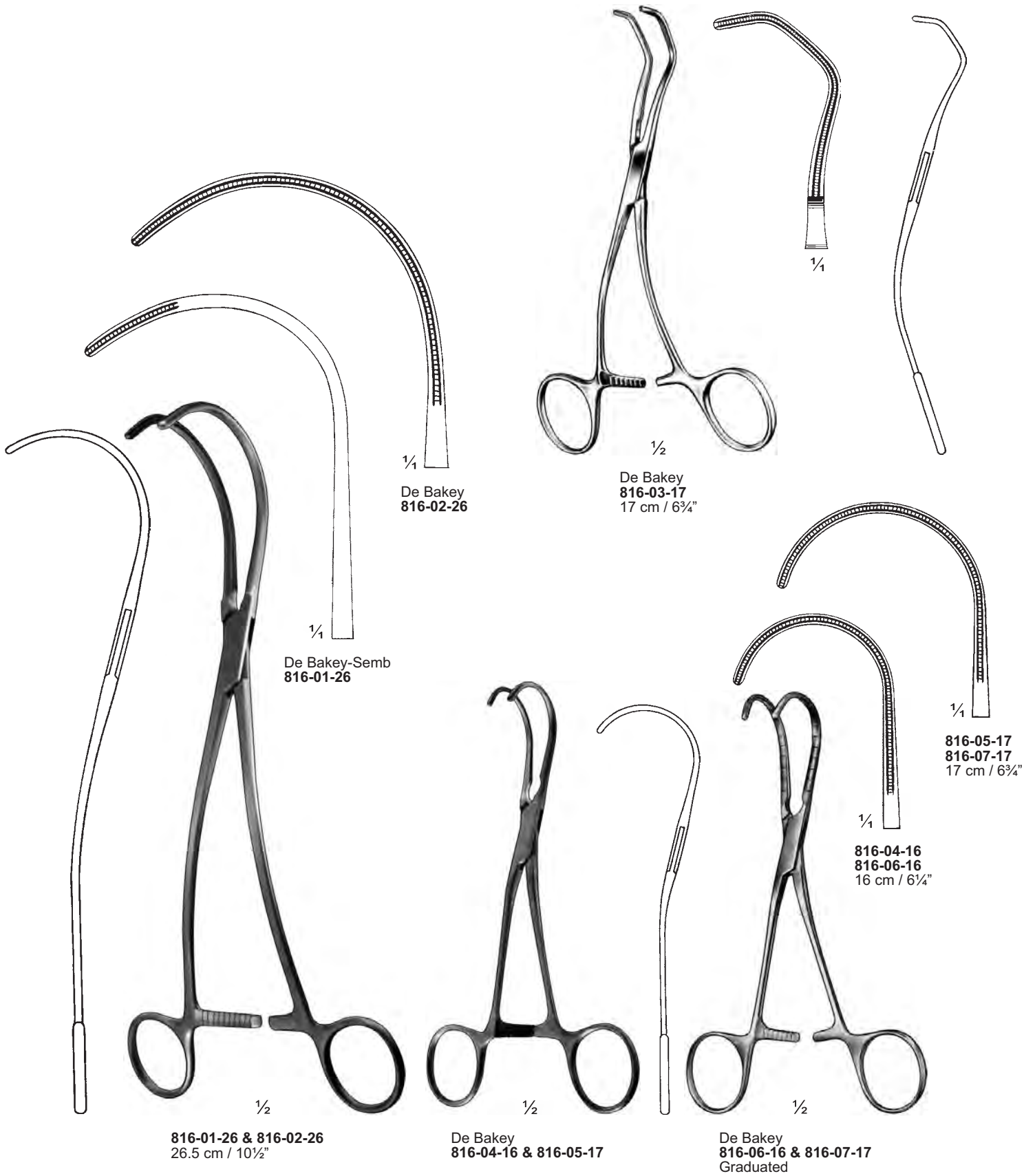

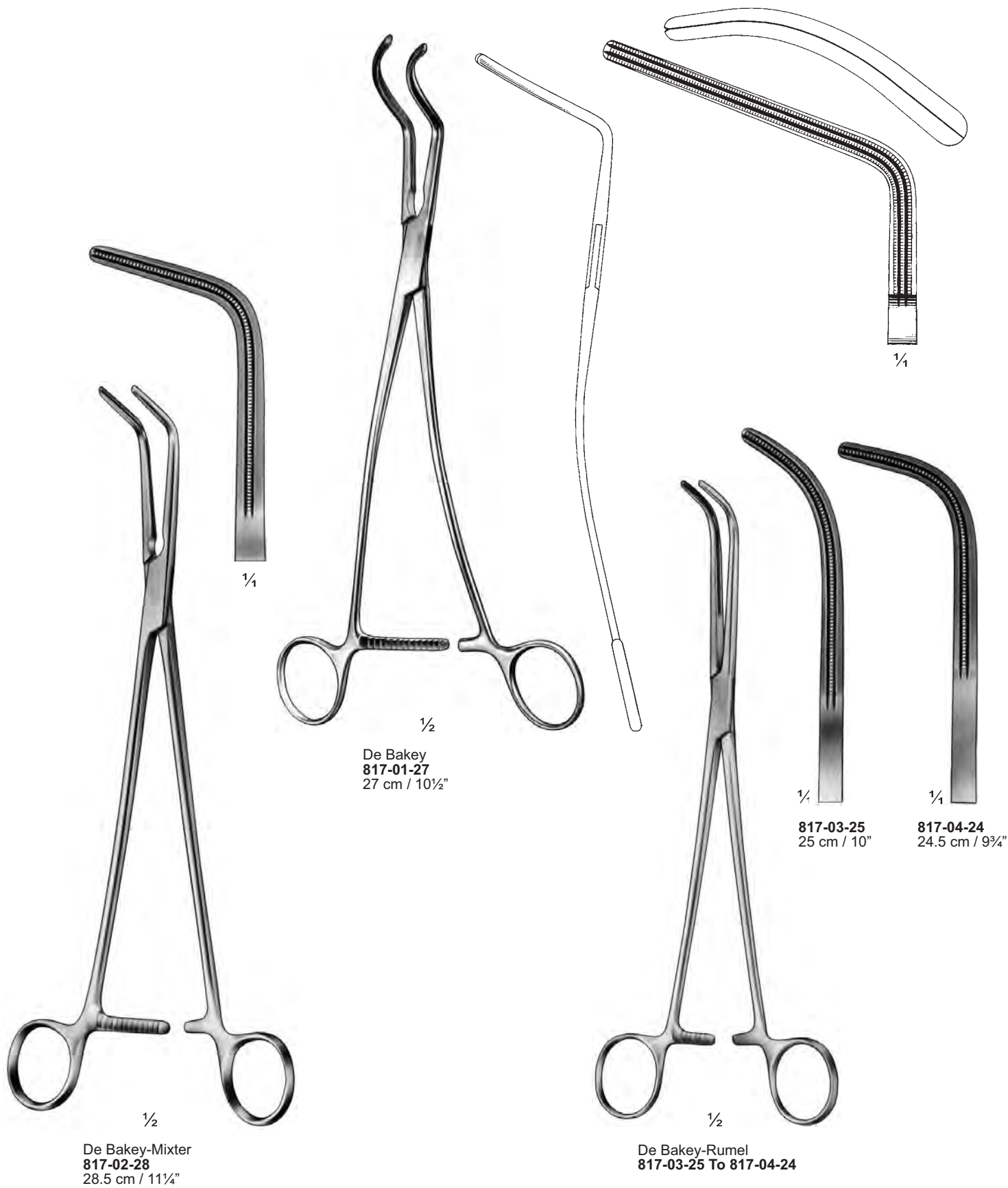

**Mehrzweck-Gefäßklemmen
Atrauma Cardiovascular Forceps
Pincers vasculaires universelles**

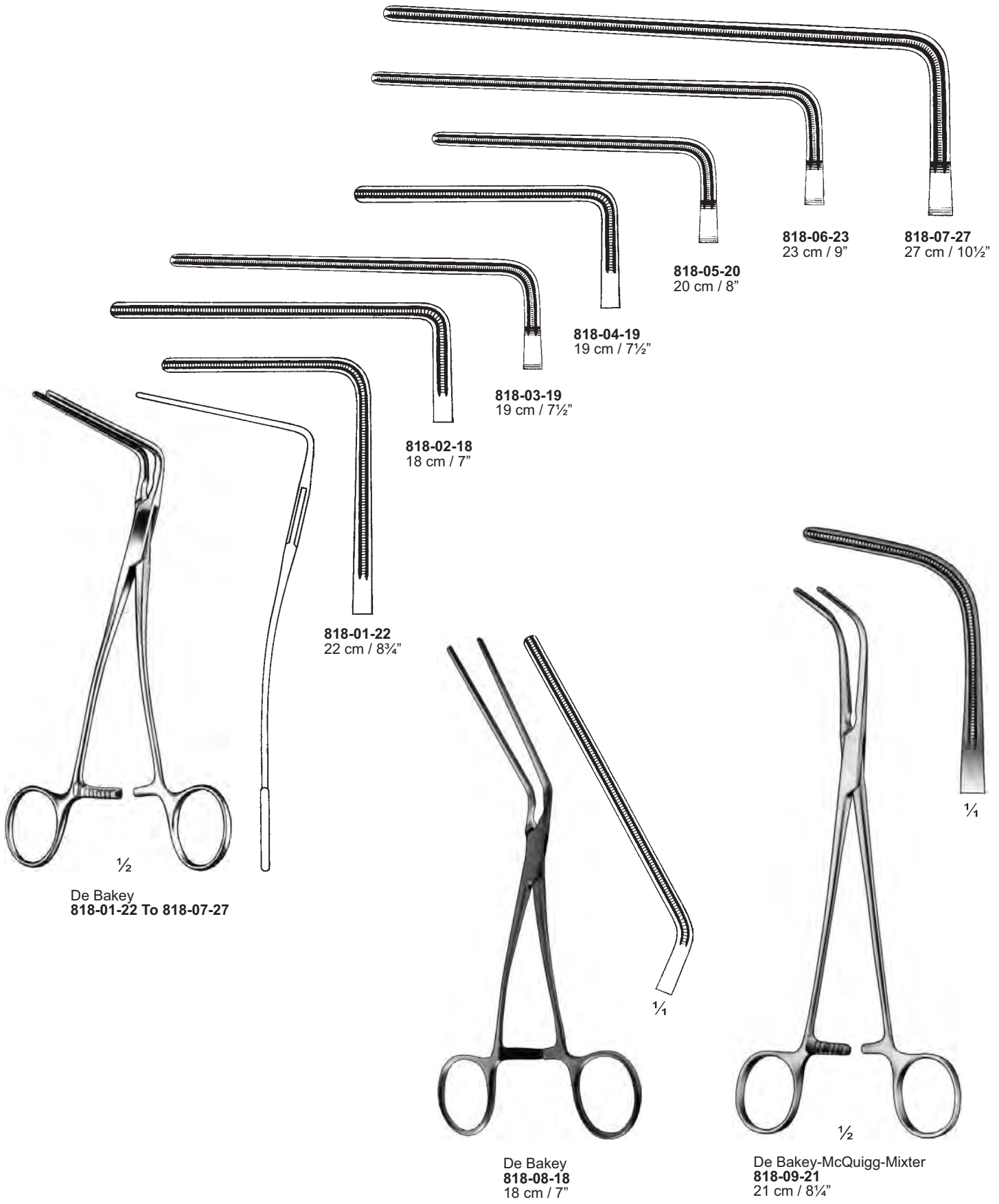

Mehrzweck-Gefäßklemmen
Atrauma Cardiovascular Forceps
Pincers vasculaires universelles

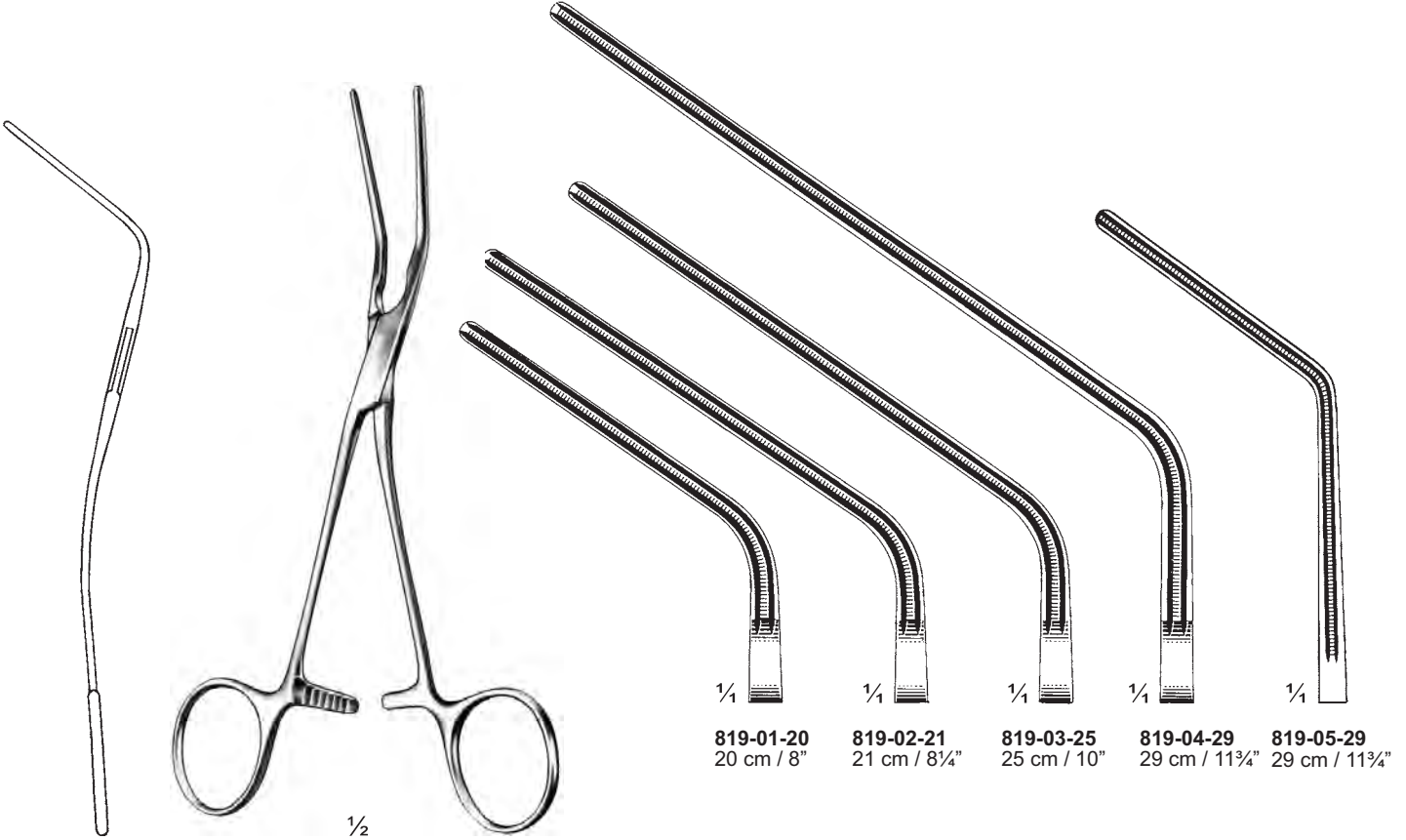

De Bakey
 819-01-20 To 819-05-29

- 819-01-20
20 cm / 8"
- 819-02-21
21 cm / 8¼"
- 819-03-25
25 cm / 10"
- 819-04-29
29 cm / 11¾"
- 819-05-29
29 cm / 11¾"

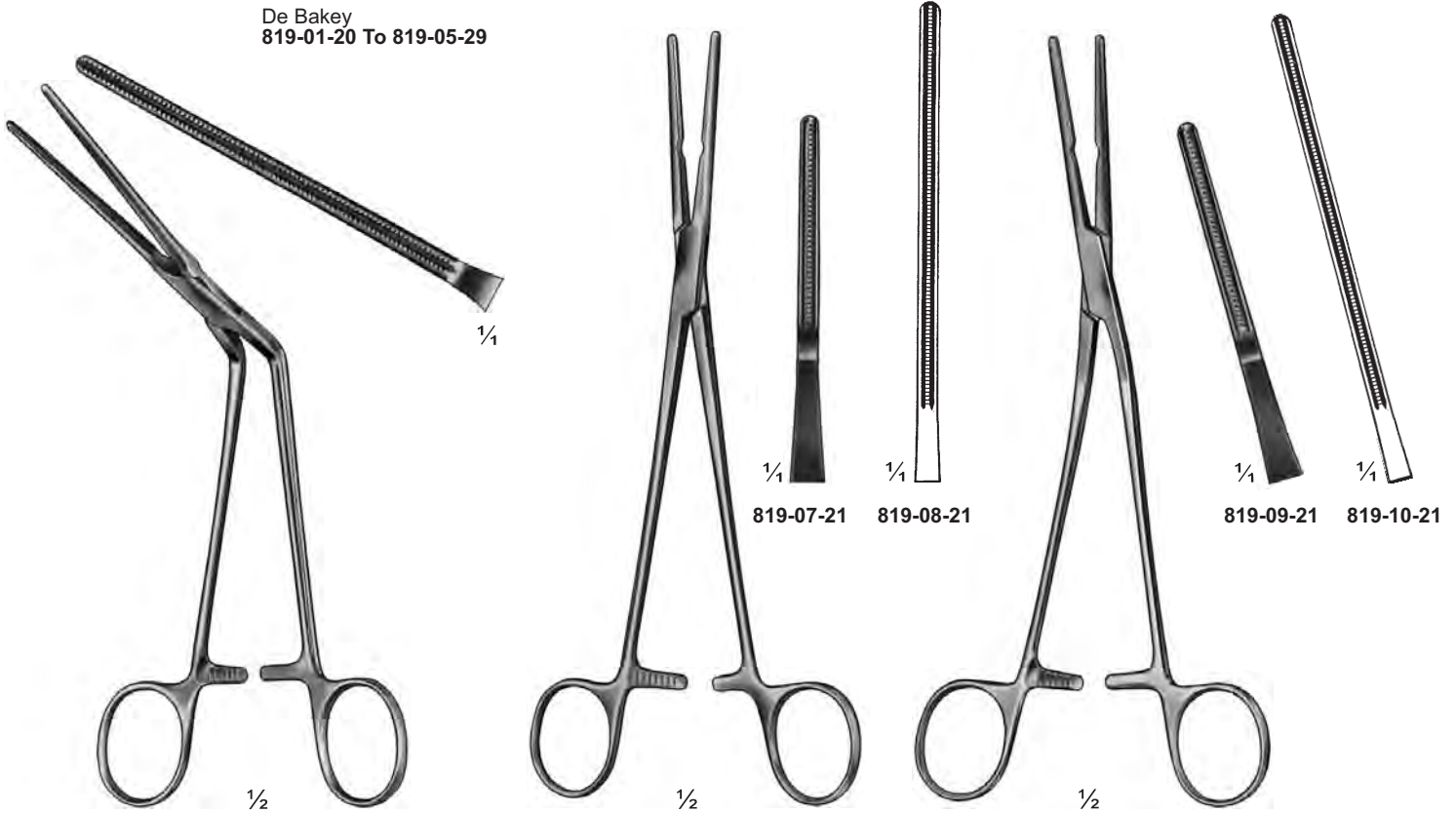

De Bakey
 819-06-20
 20 cm / 8"

De Bakey
 819-07-21 To 819-08-21
 21 cm / 8¼"

De Bakey
 819-09-21 To 819-10-21
 21 cm / 8¼"

Mehrzweck-Gefäßklemmen
Atrauma Cardiovascular Forceps
Pincers vasculaires universelles



1/2

Morris-De Bakey
 820-01-18 To 820-04-25

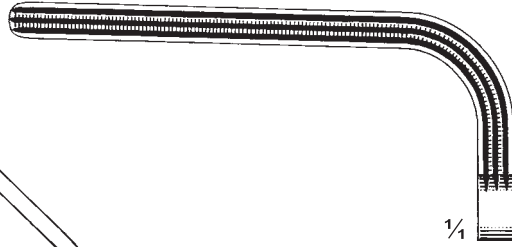
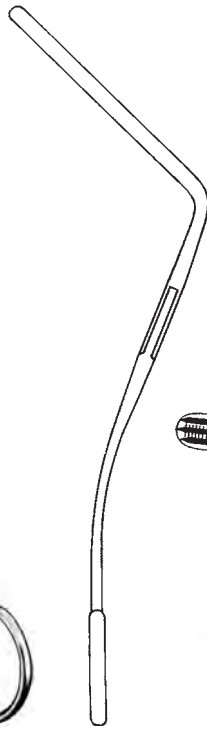

1/4

820-01-18
 18 cm / 7"

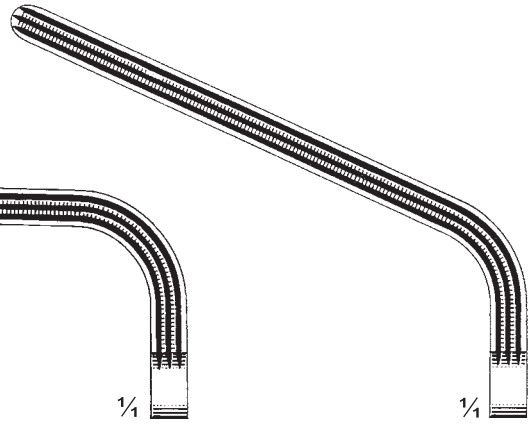

1/4

820-02-20
 20 cm / 8"

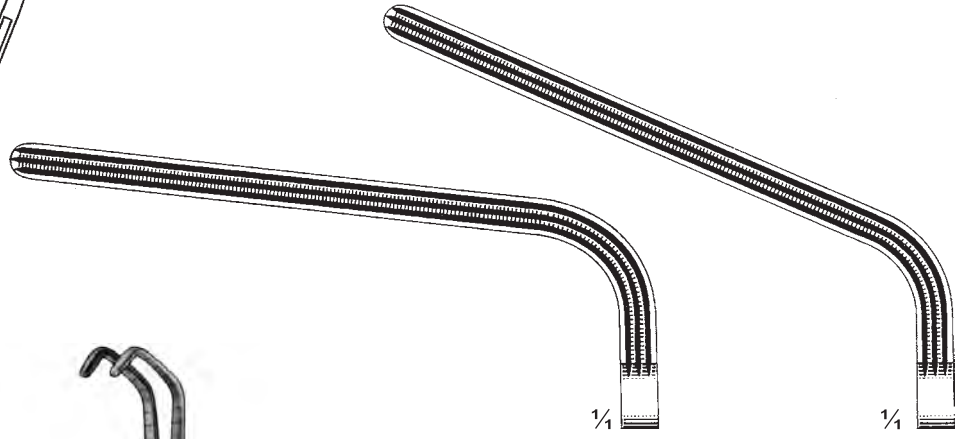

1/4

820-03-23
 23 cm / 9"

1/4

820-04-25
 25 cm / 10"



1/2

De Bakey-Beck
 820-05-20 & 820-06-21

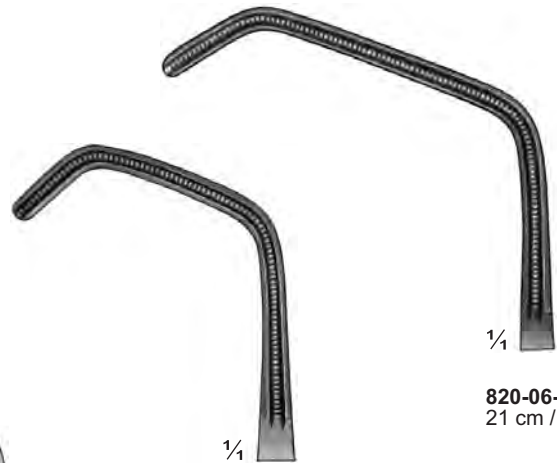

1/4

820-05-20
 20 cm / 8"

1/4

820-06-21
 21 cm / 8 1/4"

Mehrzweck-Gefäßklemmen
Atrauma Cardiovascular Forceps
Pinces vasculaires universelles

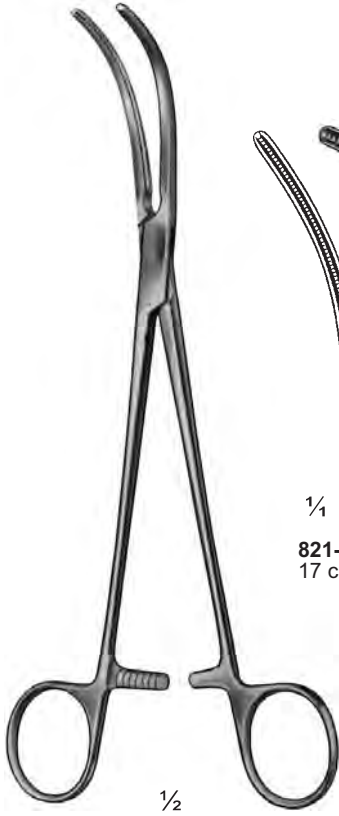

$\frac{1}{2}$
 Glover
 821-01-17 To 821-03-24

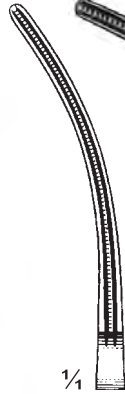

$\frac{1}{4}$
 821-01-17
 17 cm / 6 $\frac{3}{4}$ "



$\frac{1}{4}$
 821-02-21
 21.5 cm / 8 $\frac{1}{2}$ "



$\frac{1}{4}$
 821-03-24
 24.5 cm / 9 $\frac{3}{4}$ "



$\frac{1}{2}$
 Glover
 821-04 -17 To 821-05-22



$\frac{1}{4}$
 821-04-17
 17 cm / 6 $\frac{3}{4}$ "



$\frac{1}{4}$
 821-05-22
 22 cm / 8 $\frac{3}{4}$ "

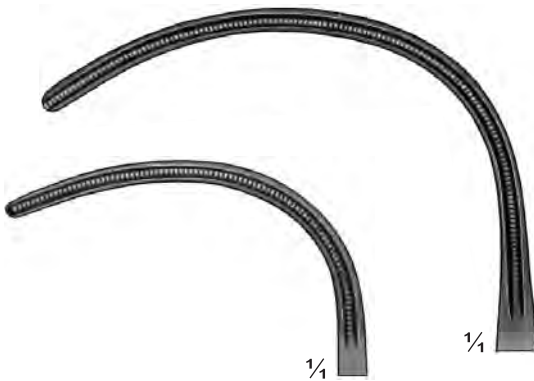

$\frac{1}{4}$
 821-06-19
 19.5 cm / 7 $\frac{3}{4}$ "

$\frac{1}{4}$
 821-07-21
 21 cm / 8 $\frac{1}{4}$ "



$\frac{1}{2}$
 Glover
 821-06-19 & 821-07-21



$\frac{1}{4}$
 821-08-21
 21 cm / 8 $\frac{1}{4}$ "

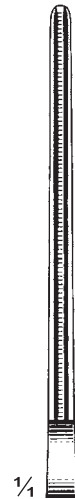

$\frac{1}{4}$
 821-09-22
 22 cm / 8 $\frac{3}{4}$ "

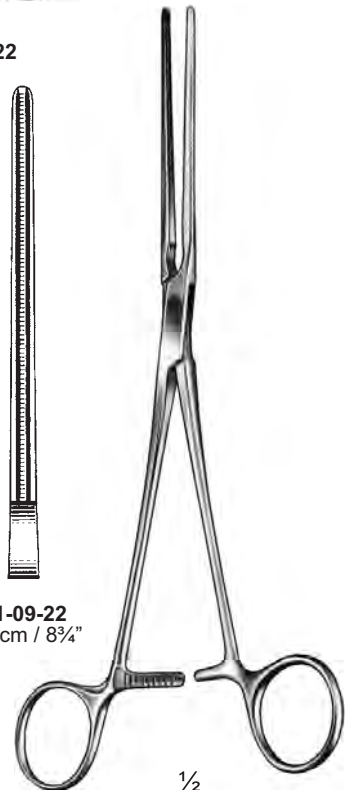

$\frac{1}{2}$
 Potts
 821-08-21 & 821-09-22

Mehrzweck-Gefäßklemmen
Atrauma Cardiovascular Forceps
Pinces vasculaires universelles



Potts
 822-01-21 & 822-02-22

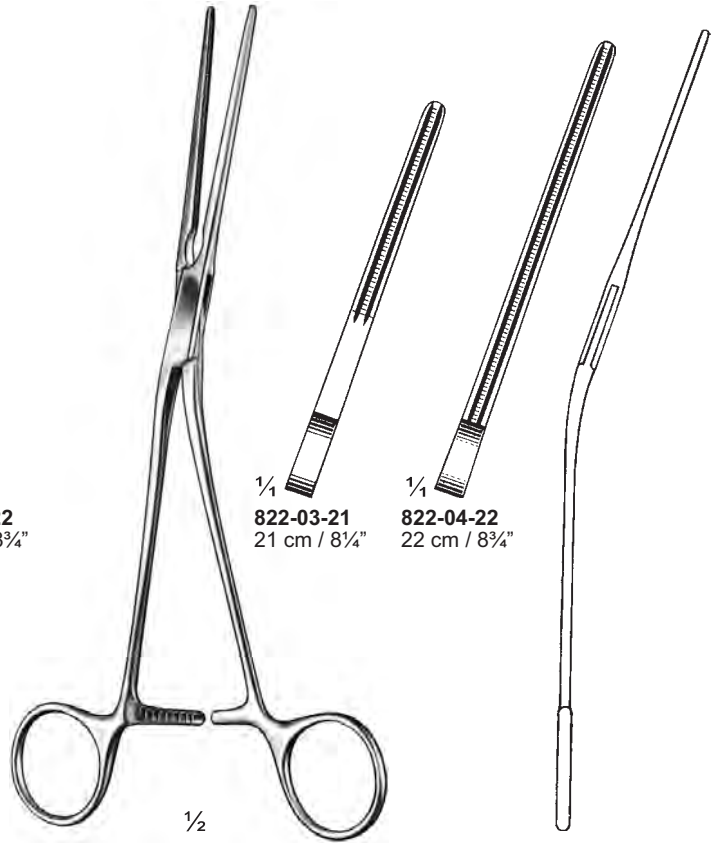
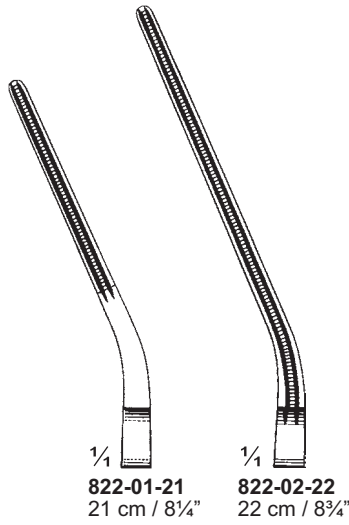

Potts
 822-03-21 & 822-04-22

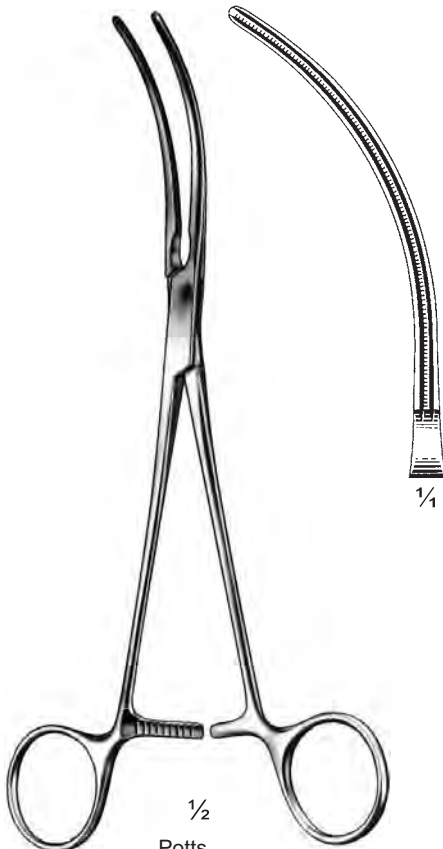

Potts
 822-05-22
 22 cm / 8 3/4"

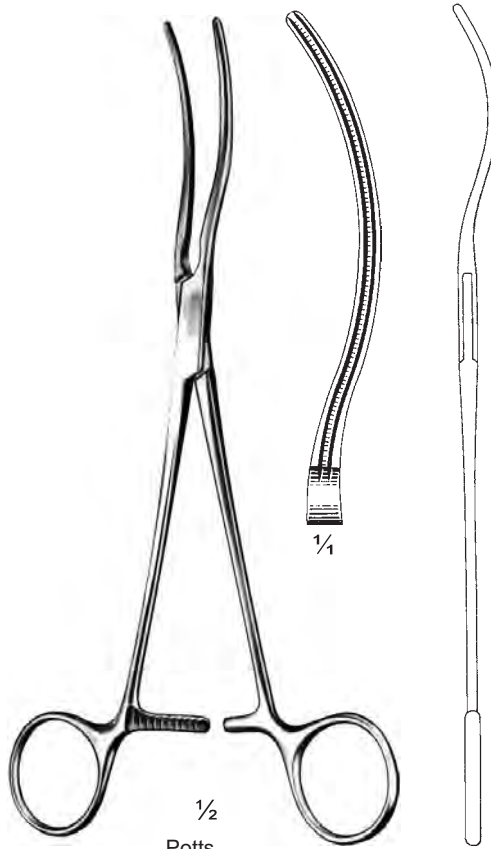

Potts
 822-06-22
 22 cm / 8 3/4"

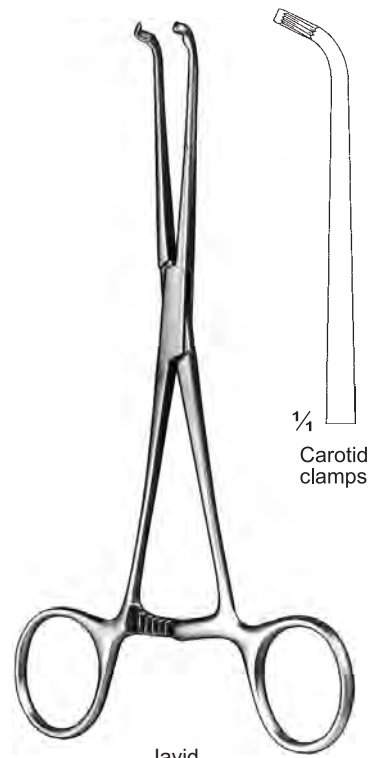

Javid
 822-07-18
 18 cm / 7"

1/4
 Carotid
 clamps

Mehrzweck-Gefäßklemmen
Atrauma Cardiovascular Forceps
Pincers vasculaires universelles

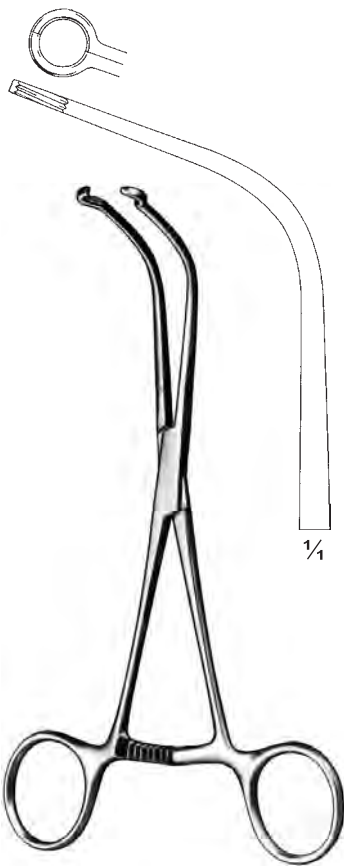

Javid
823-01-19
19 cm / 7½"



823-02-21 To 823-05-31



823-02-21
21.5 cm / 8½"



823-03-23
23 cm / 9"



823-04-27
27 cm / 10½"

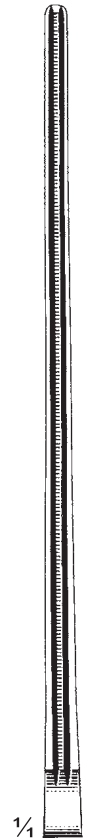

823-05-31
31.5 cm / 12½"



823-06-21 To 823-09-31

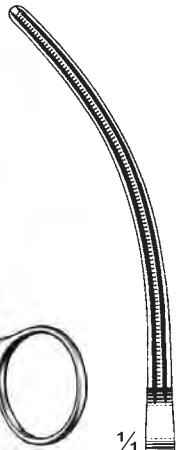

823-06-21
21.5 cm / 8½"

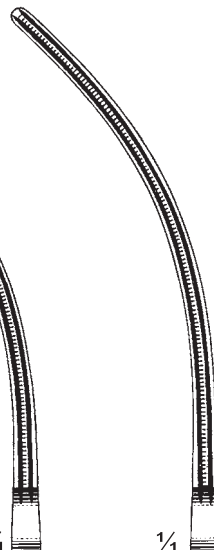

823-07-23
23 cm / 9"

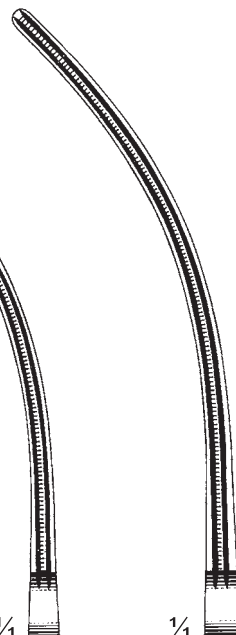

823-08-27
27 cm / 10½"

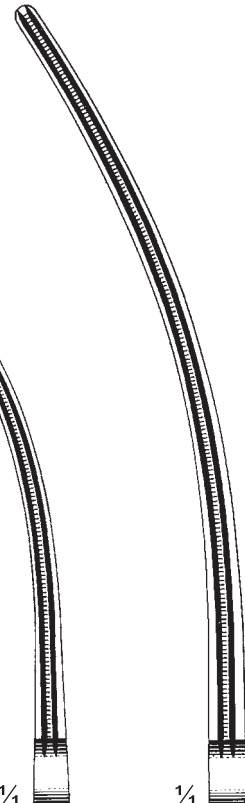

823-09-31
31.5 cm / 12½"

Mehrzweck-Gefäßklemmen
Atrauma Cardiovascular Forceps
Pincers vasculaires universelles



Satinsky
 824-01-20 To 824-05-27

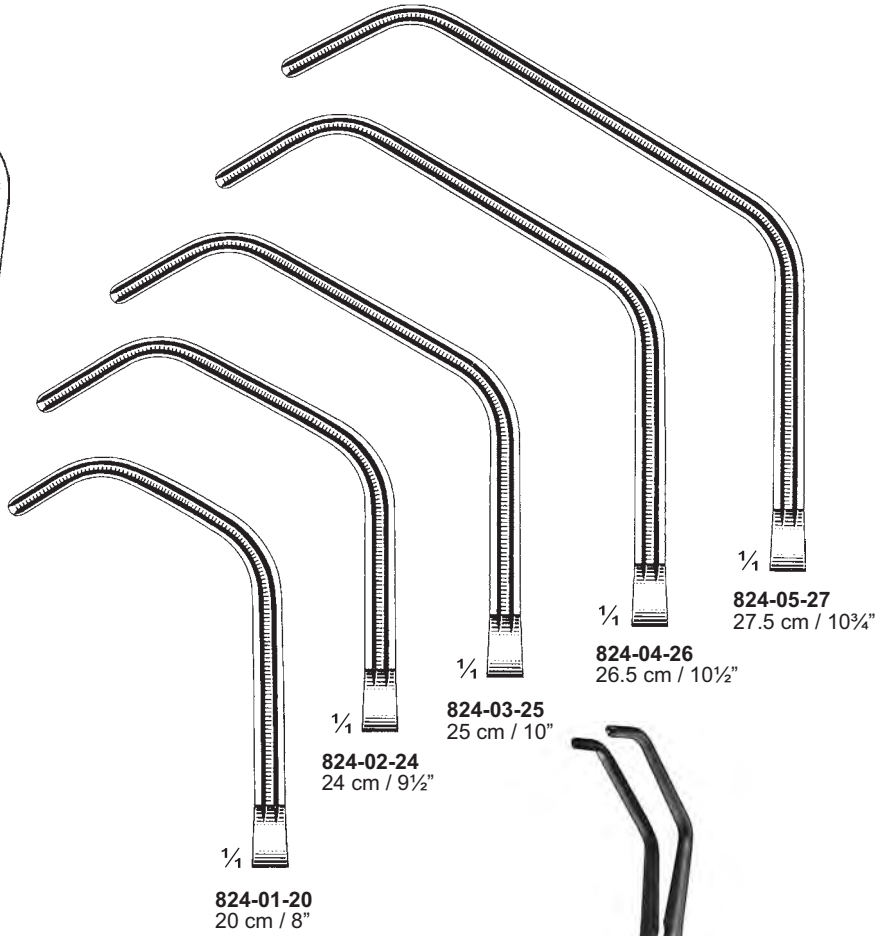

824-01-20
 20 cm / 8"

824-02-24
 24 cm / 9½"

824-03-25
 25 cm / 10"

824-04-26
 26.5 cm / 10½"

824-05-27
 27.5 cm / 10¾"

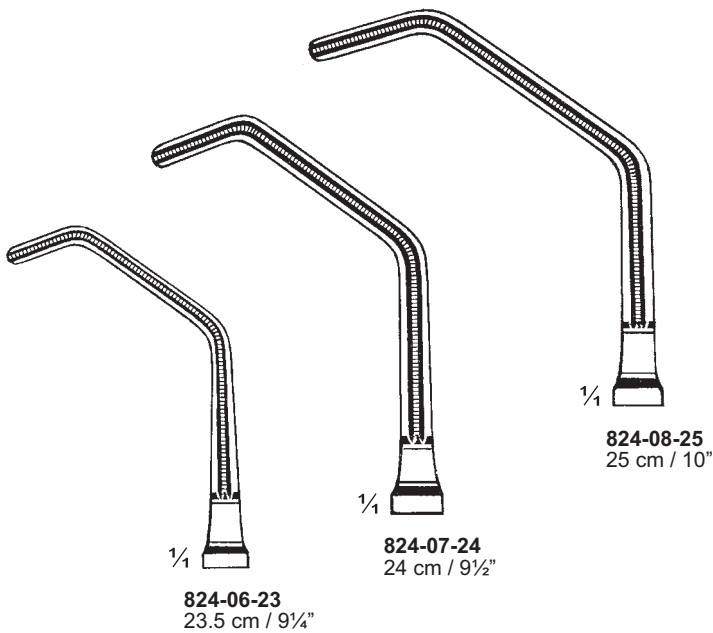

824-06-23
 23.5 cm / 9¼"

824-07-24
 24 cm / 9½"

824-08-25
 25 cm / 10"



Satinsky-De Bakey
 824-06-23 To 824-08-25

Mehrzweck-Gefäßklemmen
Atrauma Cardiovascular Forceps
Pinces vasculaires universelles



$\frac{1}{4}$
Lambert-Kay
825-01-21
 21 cm / 8 $\frac{1}{4}$ "



$\frac{1}{4}$
Lambert-Kay
825-02-21
 21.5 cm / 8 $\frac{1}{2}$ "



$\frac{1}{4}$
Lambert-Kaya Modif.
825-03-25
 25 cm / 10"



$\frac{1}{2}$
825-01-21 To 825-03-25



$\frac{1}{4}$



Glover-De Bakey
825-04-23
 23 cm / 9"



$\frac{1}{4}$



$\frac{1}{2}$
Atlee
825-05-24
 24.5 cm / 9 $\frac{3}{4}$ "

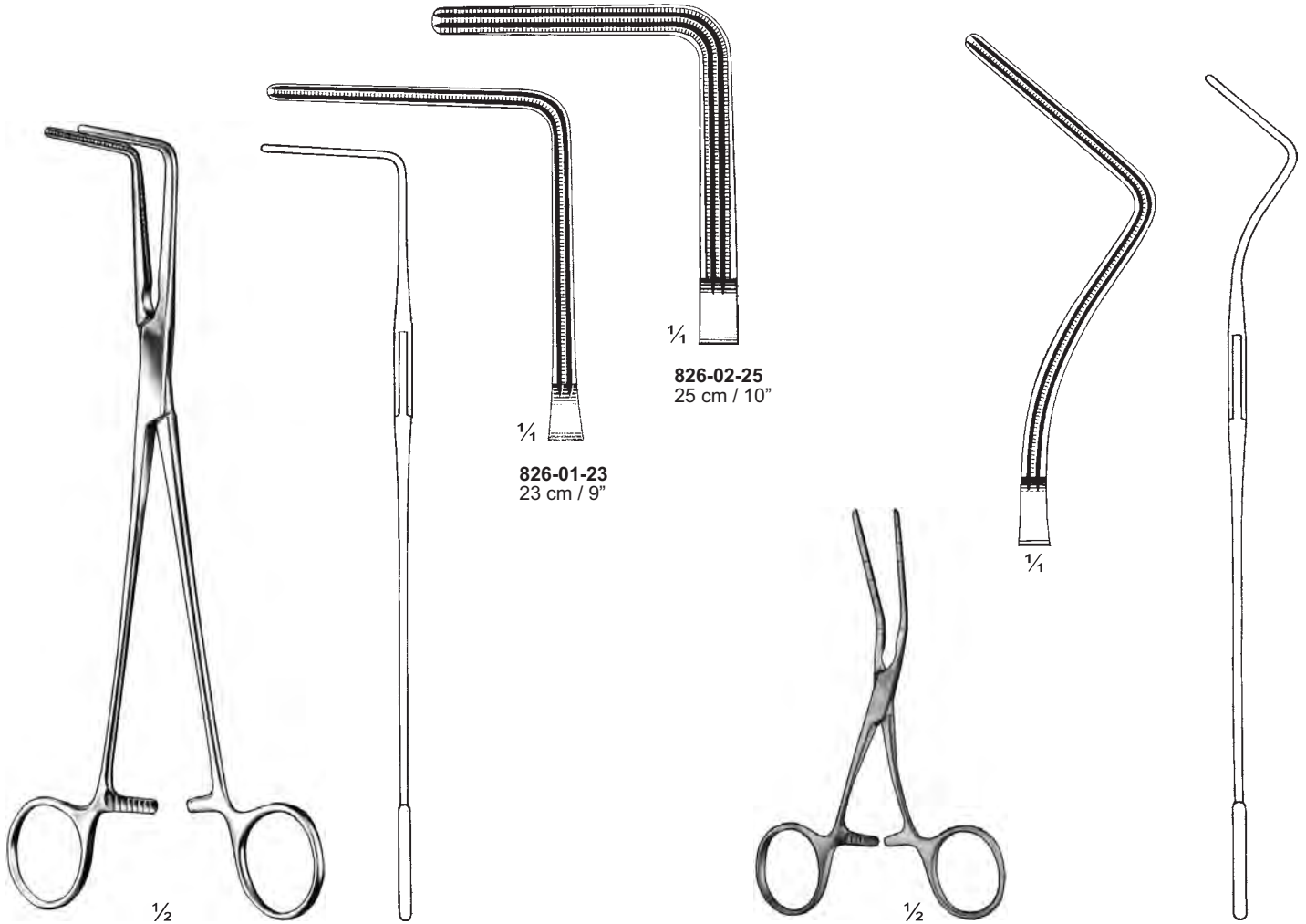

Lees
826-01-23 & 826-02-25

Lees
826-03-25
25 cm / 10"

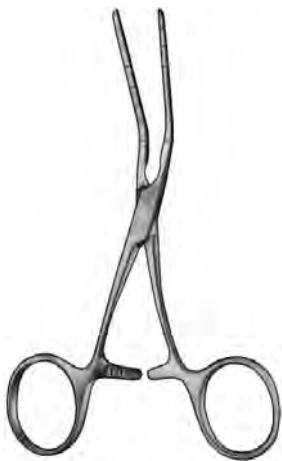

Castaneda
826-04-12 To 826-07-10
Graduated



$\frac{1}{4}$
826-04-12
12.5 cm / 5"



$\frac{1}{4}$
826-05-12
12 cm / 4 $\frac{3}{4}$ "
30°



$\frac{1}{4}$
826-06-12
12 cm / 4 $\frac{3}{4}$ "
45°



$\frac{1}{4}$
826-07-10
10.5 cm / 4 $\frac{1}{8}$ "
90°

Mehrzweck-Gefäßklemmen
Atrauma Cardiovascular Forceps
Pinces vasculaires universelles



$\frac{1}{2}$
 De Bakey-Harken
 827-01-25 To 827-04-24



$\frac{1}{4}$
827-01-25
 25 cm / 10"



$\frac{1}{4}$
827-02-24
 24.5 cm / 9 $\frac{3}{4}$ "



$\frac{1}{4}$
827-03-24
 24.5 cm / 9 $\frac{3}{4}$ "

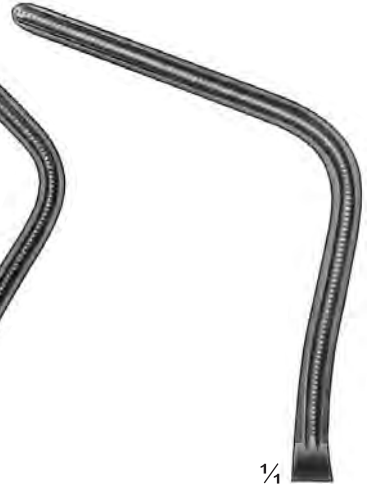

$\frac{1}{4}$
827-04-24
 24.5 cm / 9 $\frac{3}{4}$ "

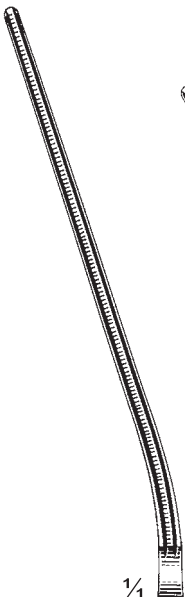

$\frac{1}{4}$
827-05-20
 20 cm / 8"



$\frac{1}{4}$
827-06-19
 19 cm / 7 $\frac{1}{2}$ "

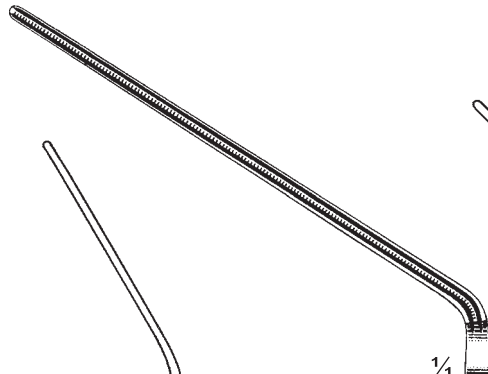

$\frac{1}{4}$
827-07-18
 18 cm / 7"

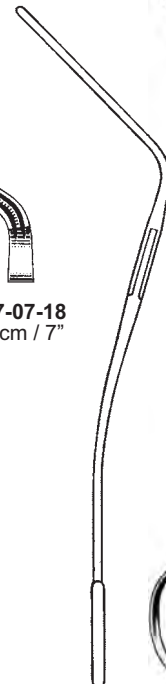

$\frac{1}{2}$
 Leland-Jones
 827-05-20 To 827-07-18

Mehrzweck-Gefäßklemmen
Atrauma Cardiovascular Forceps
Pinces vasculaires universelles

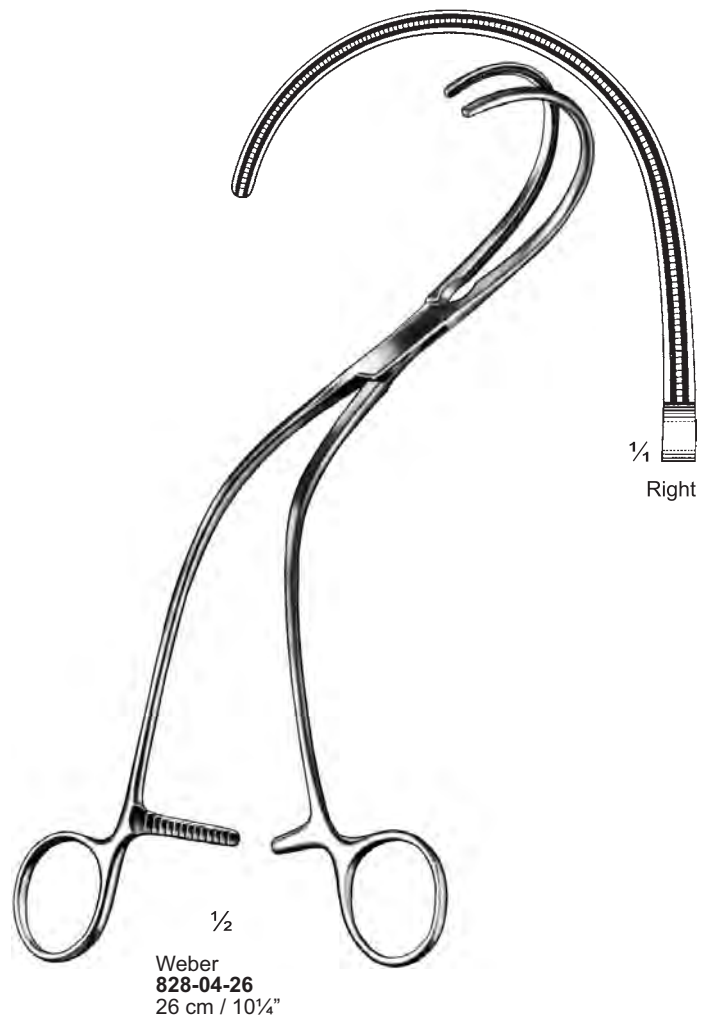
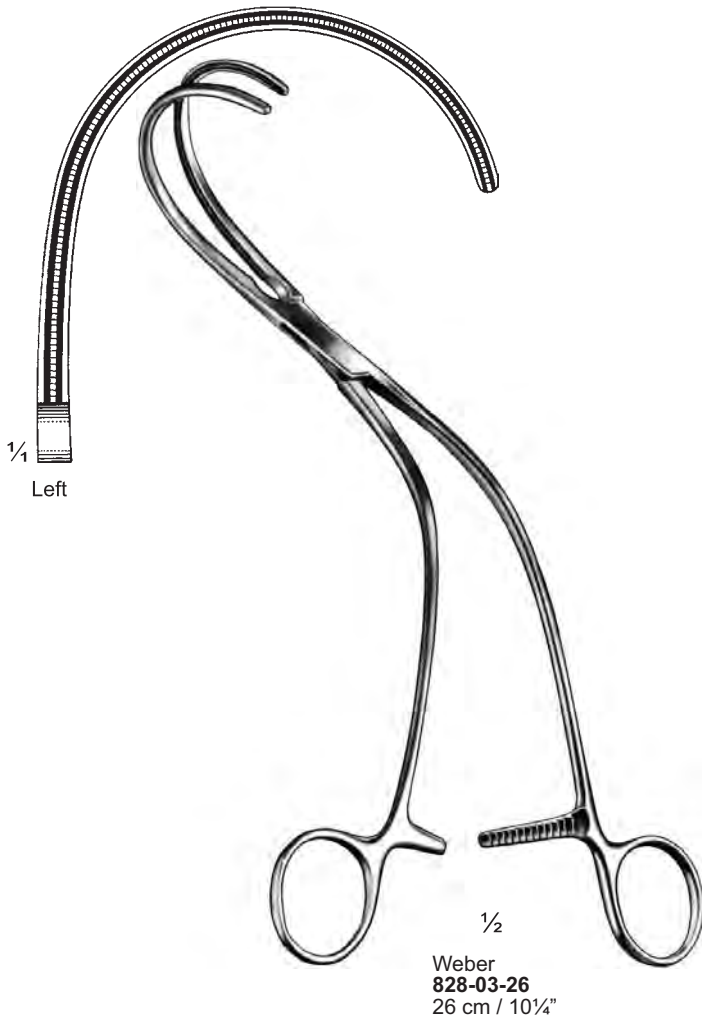
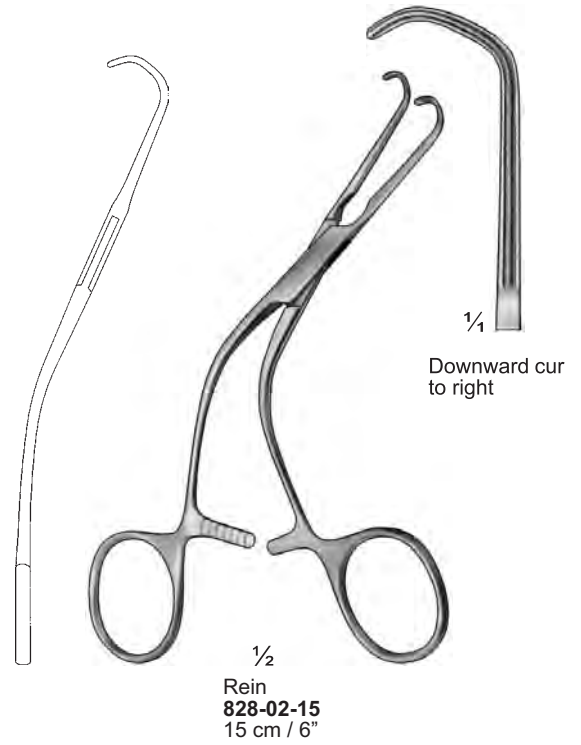
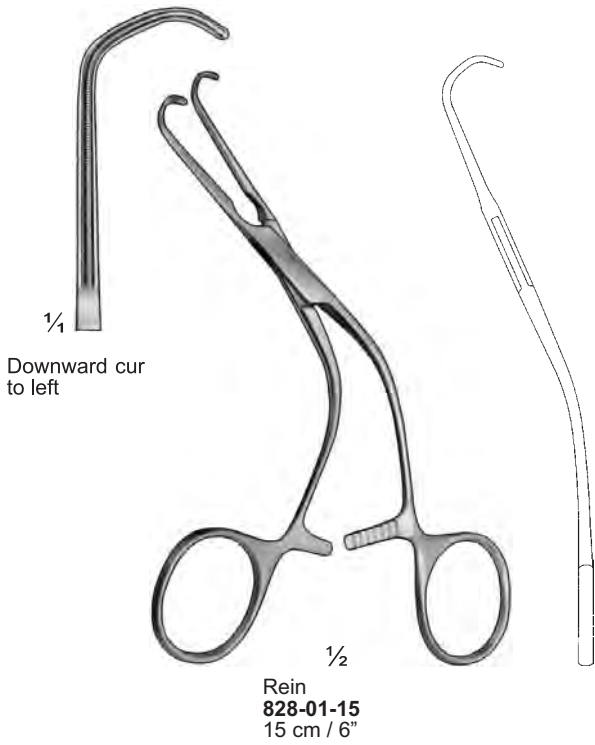

Mehrzweck-Gefäßklemmen
Atrauma Cardiovascular Forceps
Pinces vasculaires universelles

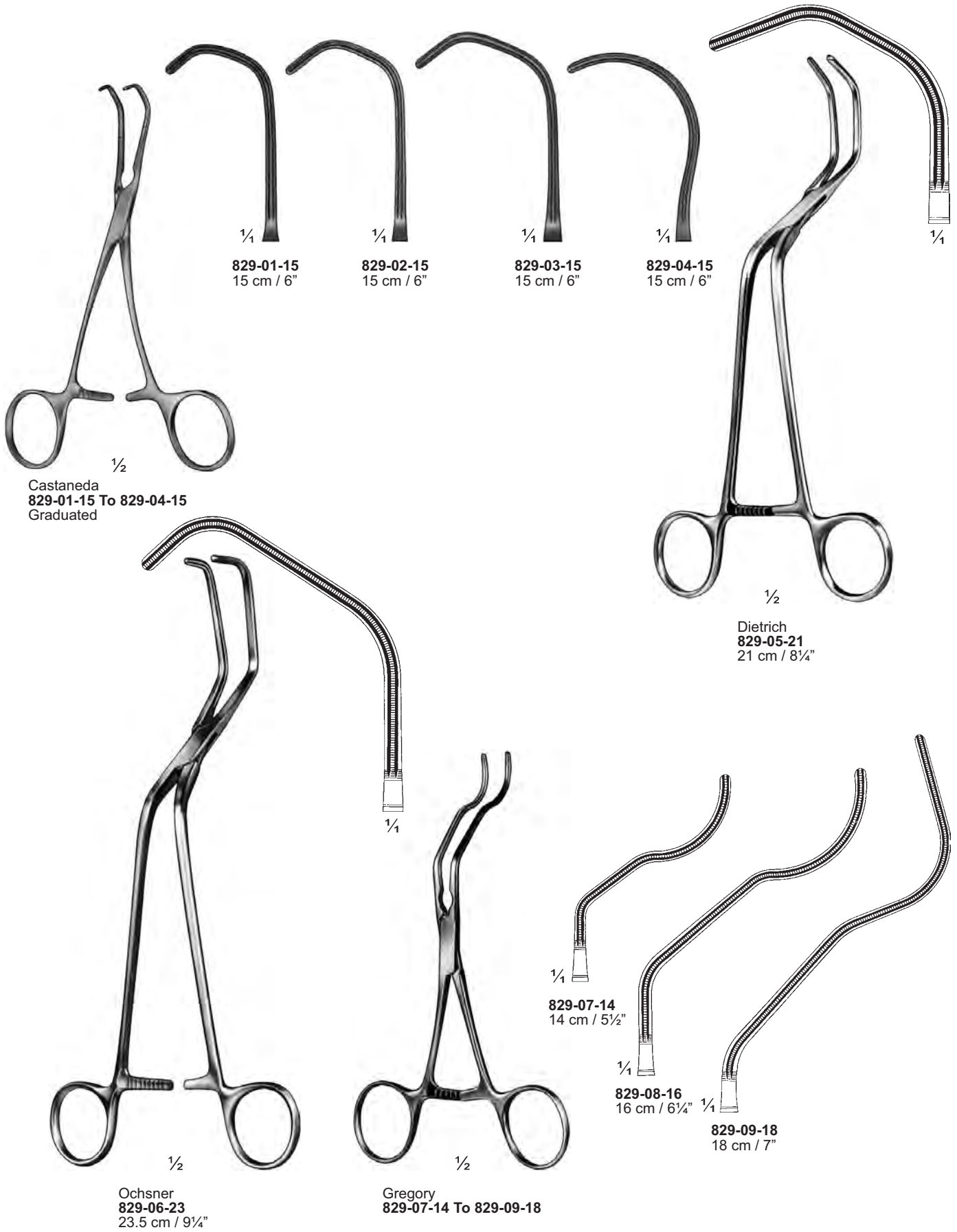

Mehrzweck-Gefäßklemmen
Atrauma Cardiovascular Forceps
Pinces vasculaires universelles



830-01-13
 13 cm / 5 1/8"

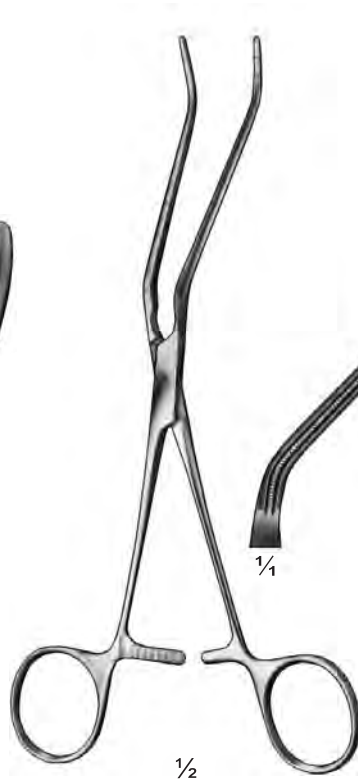

Henly
830-02-19
 19.5 cm / 7 3/4"
 Graduated

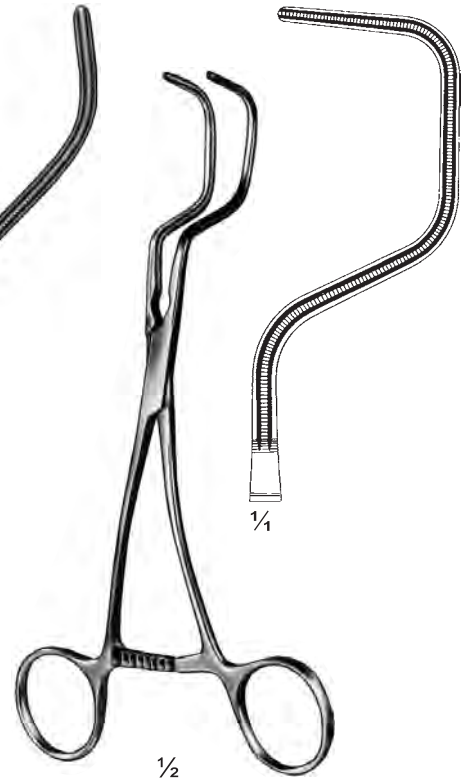

Dale
830-03-18
 18.5 cm / 7 1/4"

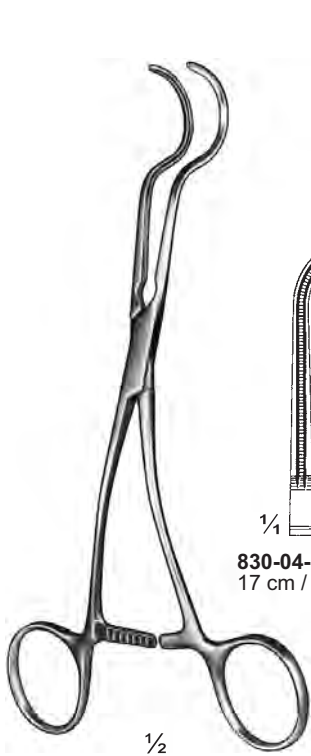

Dale
830-04-17 To 830-06-18

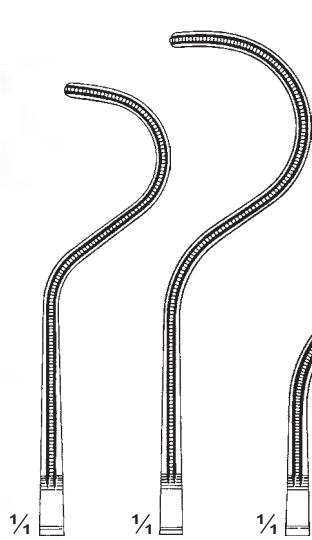

830-04-17
 17 cm / 6 3/4"

830-05-18
 18 cm / 7"

830-06-18
 18.5 cm / 7 1/4"



Derra
830-07-16 To 830-09-18

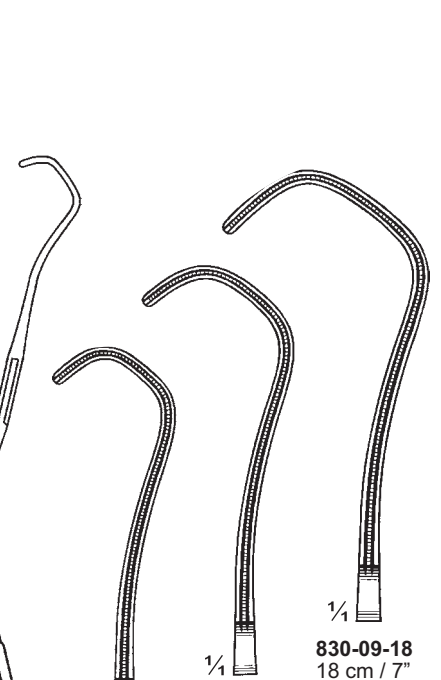

830-07-16
 16 cm / 6 1/4"



830-08-17
 17 cm / 6 3/4"

830-09-18
 18 cm / 7"

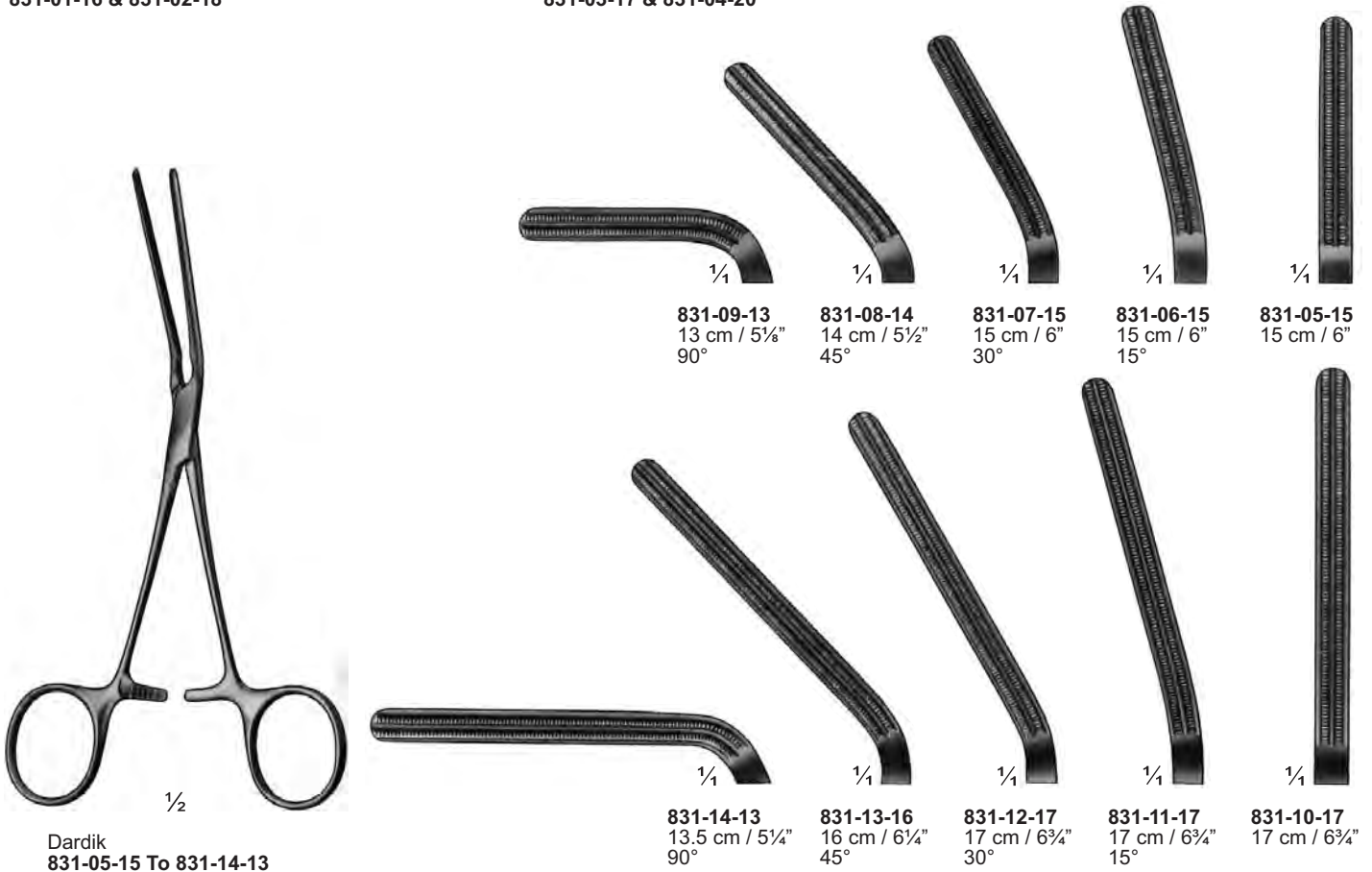
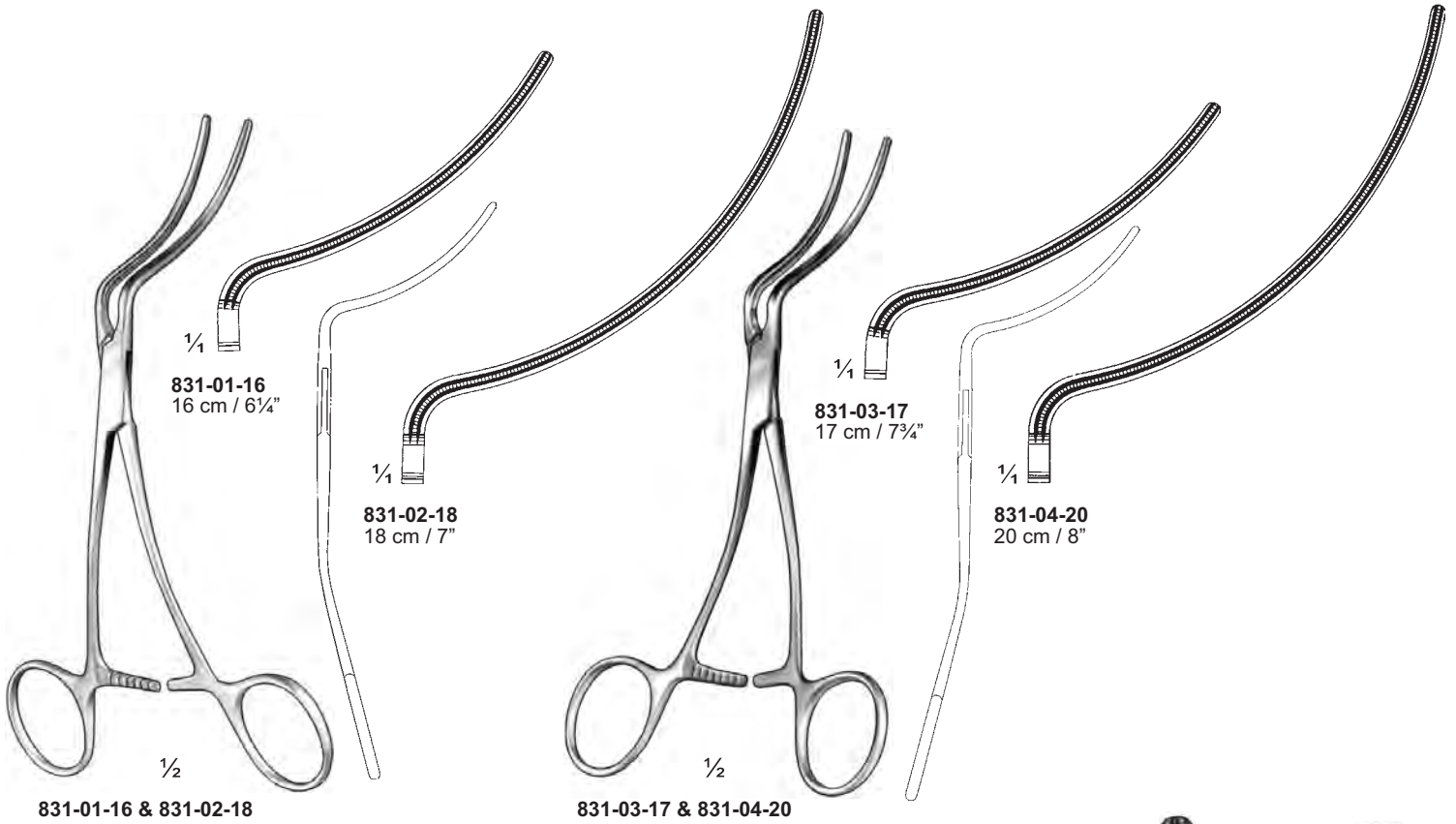
Mehrzweck-Gefäßklemmen
Atrauma Cardiovascular Forceps
Pincers vasculaires universelles

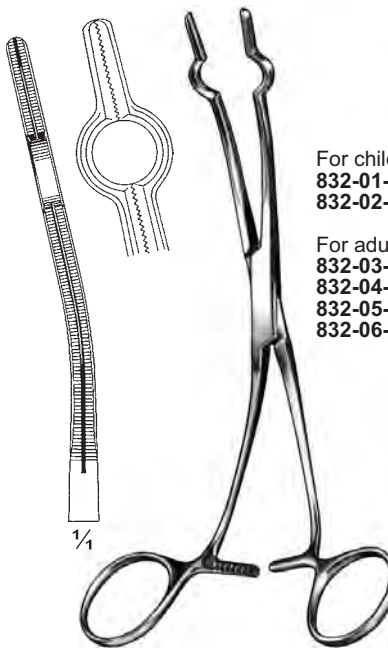
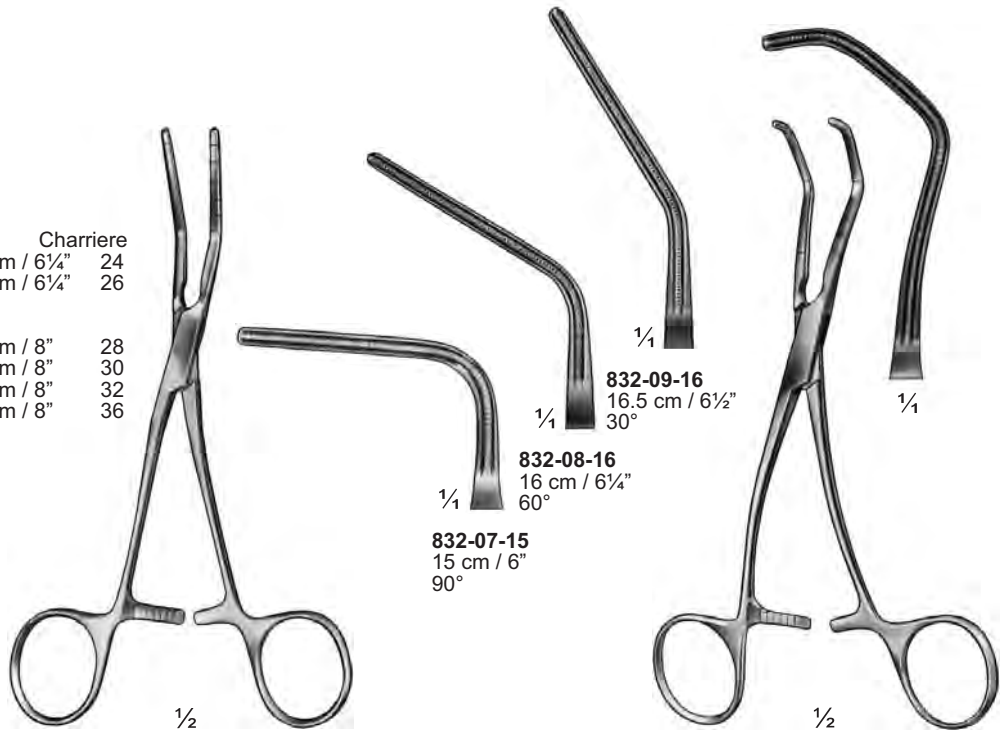

Mehrzweck-Gefäßklemmen Atrauma Cardiovascular Forceps Pincers vasculaires universelles

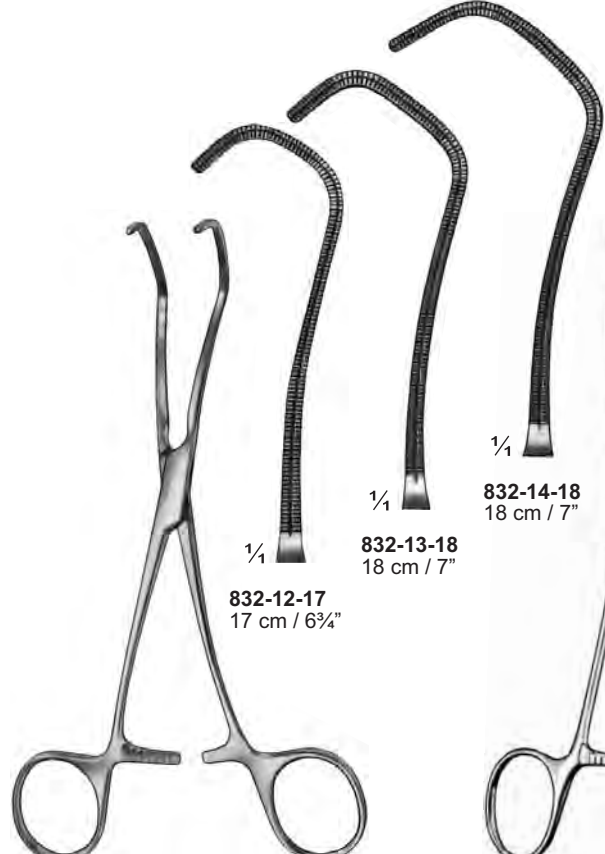
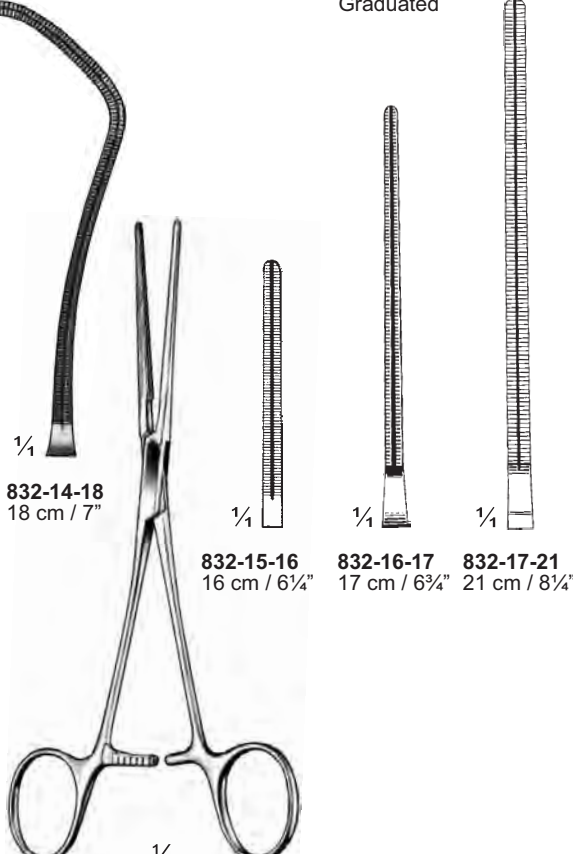
	<p>For children</p> <p>832-01-24 16 cm / 6¼" 24</p> <p>832-02-26 16 cm / 6¼" 26</p>	<p>Charriere</p>	
	<p>For adults</p> <p>832-03-28 20 cm / 8" 28</p> <p>832-04-30 20 cm / 8" 30</p> <p>832-05-32 20 cm / 8" 32</p> <p>832-06-36 20 cm / 8" 36</p>		
<p>Cooley</p> <p>832-01-24 To 832-06-36</p>	<p>Cooley</p> <p>832-07-15 To 832-09-16</p> <p>Graduated</p>		<p>Cooley</p> <p>832-10-16</p> <p>16 cm / 6¼"</p> <p>Graduated</p>
	<p>Graduated</p>		
<p>Cooley</p> <p>832-12-17 To 832-14-18</p> <p>Graduated</p>		<p>Cooley</p> <p>832-15-16 To 832-17-21</p>	

Mehrzweck-Gefäßklemmen
Atrauma Cardiovascular Forceps
Pincers vasculaires universelles

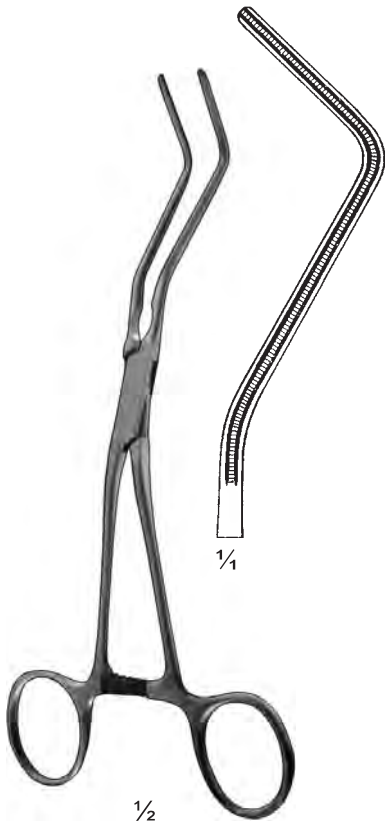

833-01-19
 19.5 cm / 7³/₄"

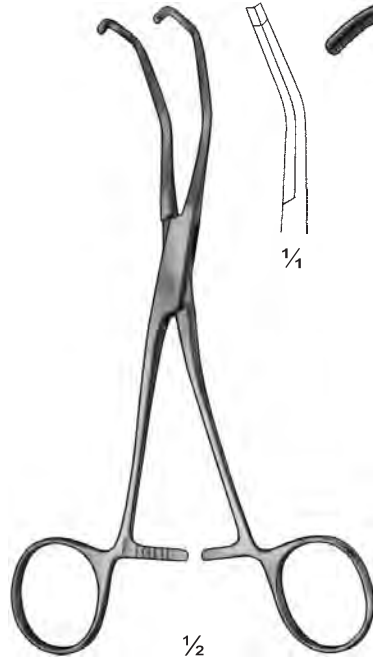

Cooley
833-02-17
 17 cm / 6³/₄"

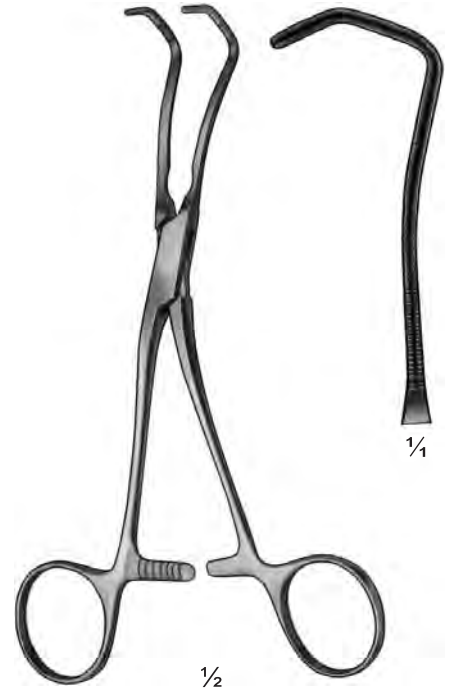

Cooley
833-03-18
 18 cm / 7"

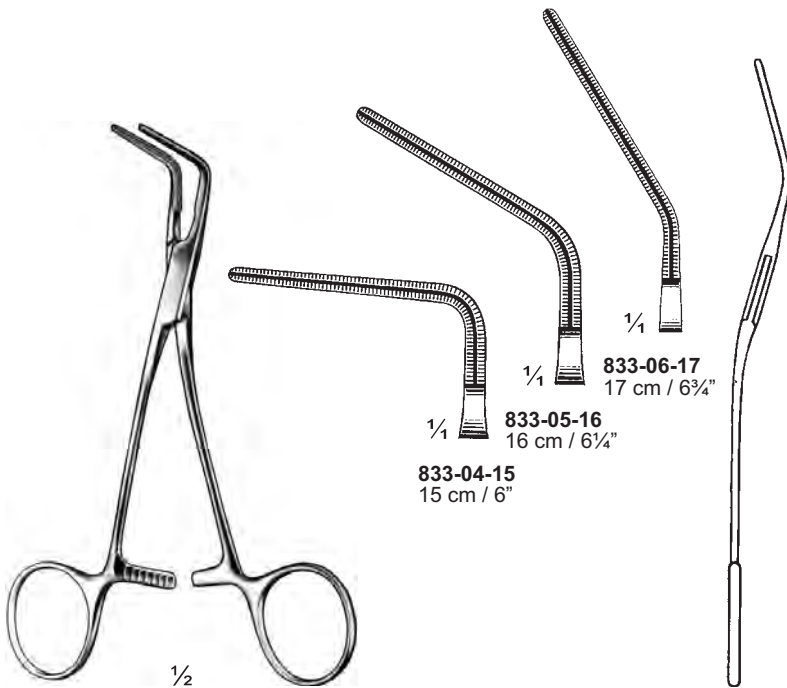

Cooley
833-04-15 To 833-06-17

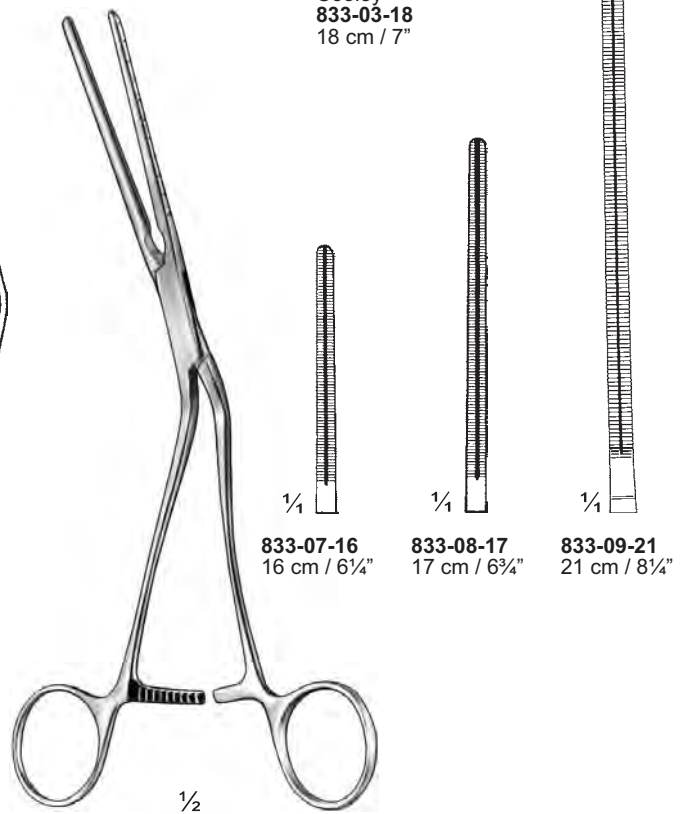

Cooley
833-07-16 To 833-09-21

Mehrzweck-Gefäßklemmen
Atrauma Cardiovascular Forceps
Pincers vasculaires universelles



Cooley
834-01-19
 19 cm / 7½"



Cooley
834-02-16 & 834-03-17

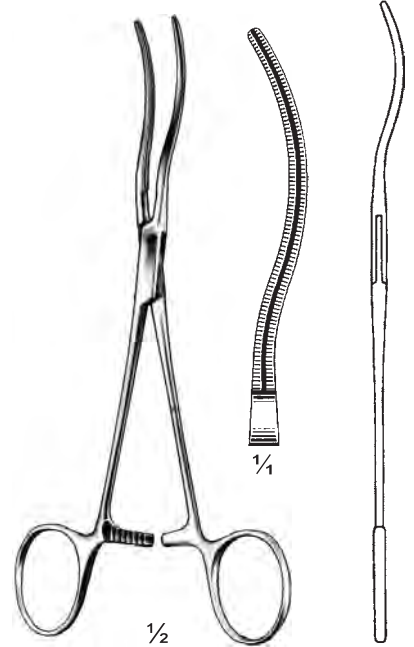

Cooley
834-04-17
 17 cm / 6¾"

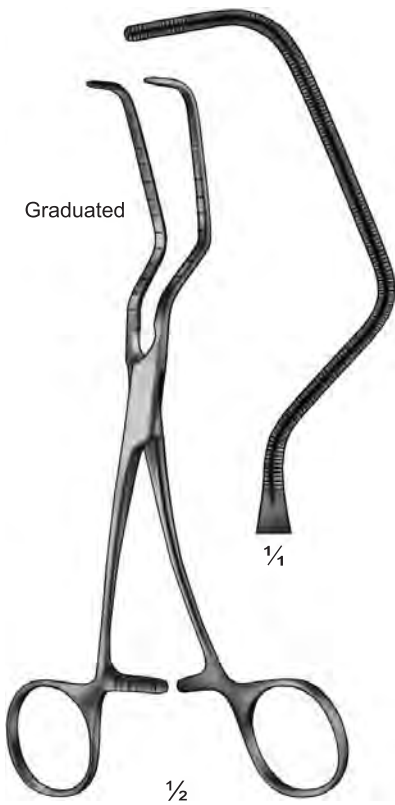

Parry-Cooley
834-05-18
 18.5 cm / 7¼"

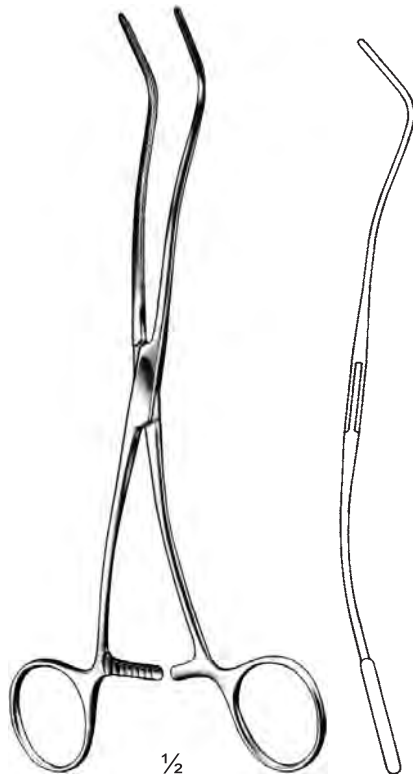

Cooley
834-06-18 To 834-08-26

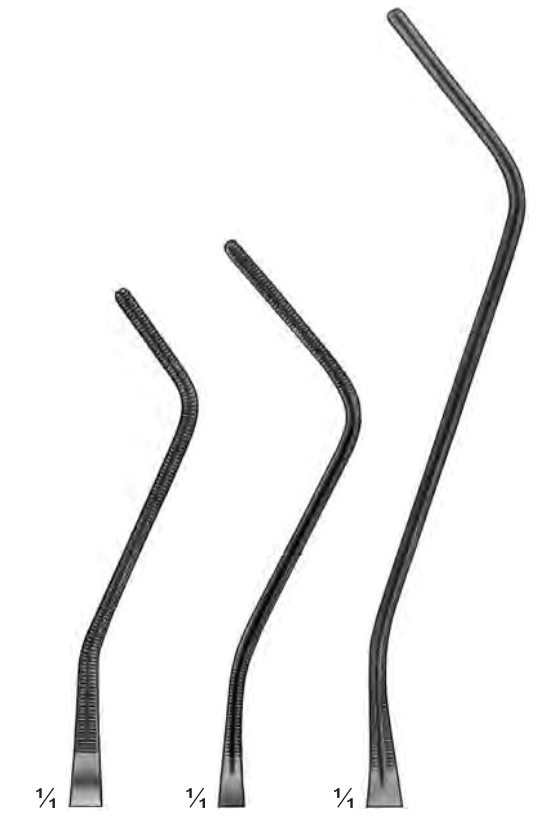

834-06-18 18.5 cm / 8¼"
834-07-19 19.5 cm / 7¾"
834-08-26 26 cm / 10¼"

Mehrzweck-Gefäßklemmen
Atrauma Cardiovascular Forceps
Pinces vasculaires universelles

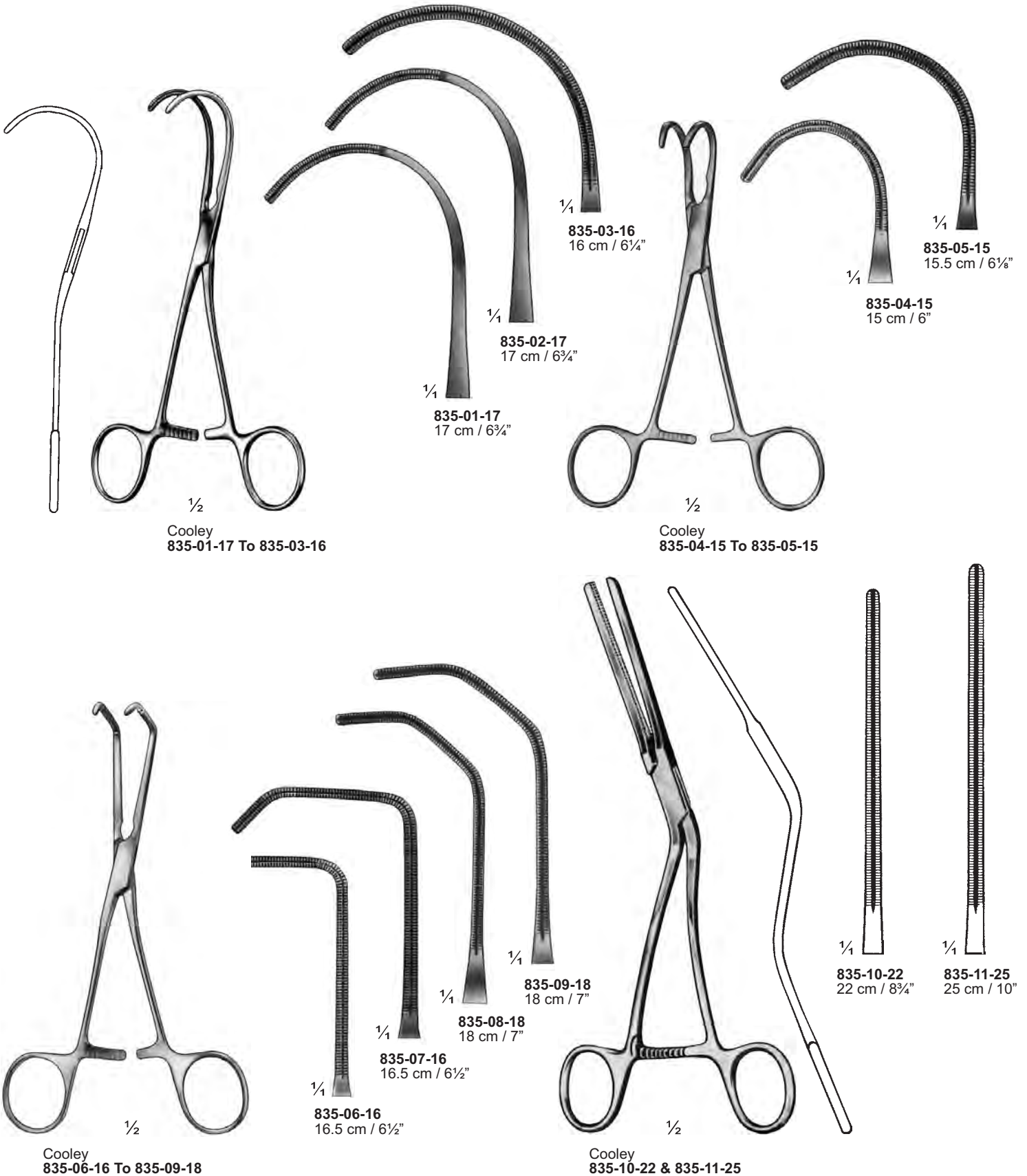

Mehrzweck-Gefäßklemmen
Atrauma Cardiovascular Forceps
Pincers vasculaires universelles

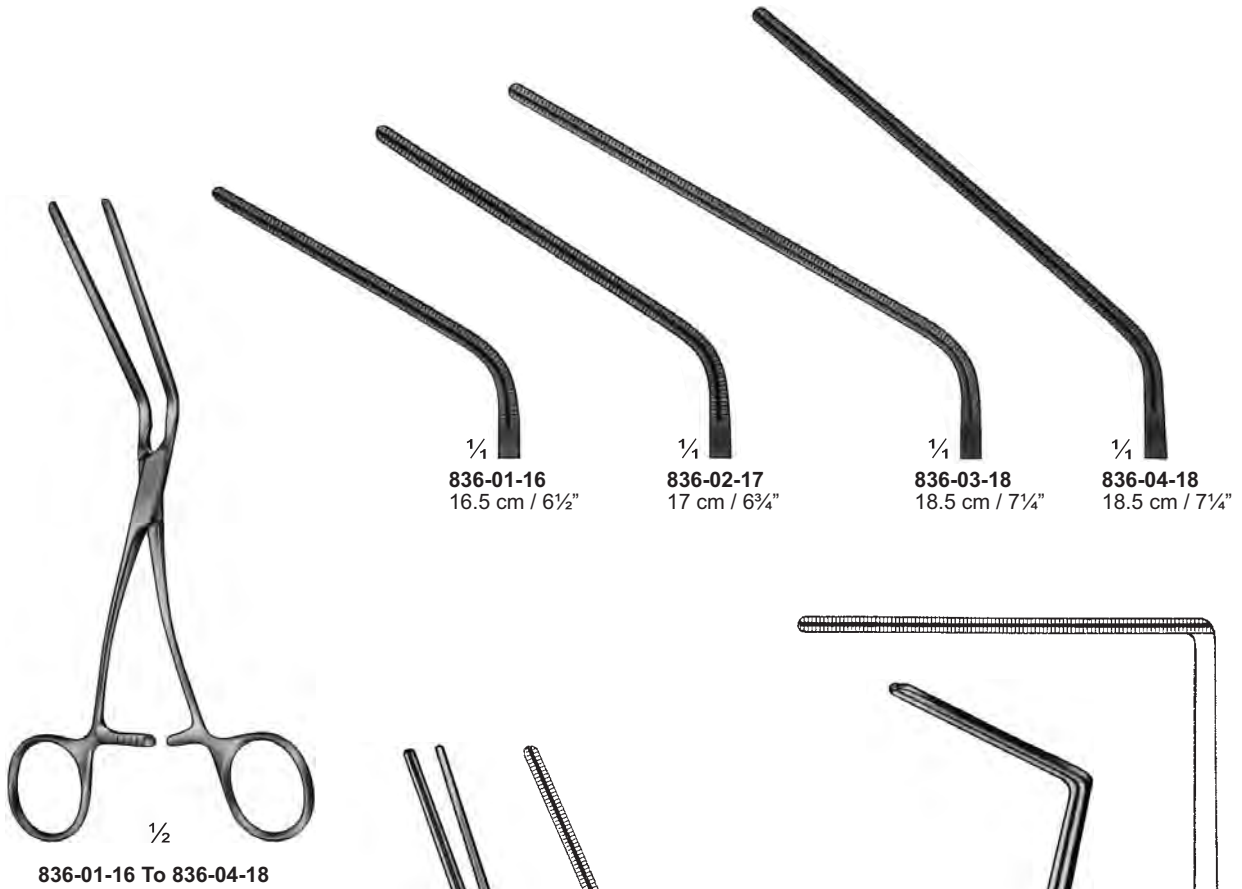

Mehrzweck-Gefäßklemmen
Atrauma Cardiovascular Forceps
Pincers vasculaires universelles



1/4



1/2

Werthiem
837-01-25
 25 cm / 10"



1/2

Dick
837-02-25 To 837-04-27



1/4

837-02-25
 25 cm / 10"

1/4

837-03-26
 26.5 cm / 10 1/2"

1/4

837-04-27
 27.5 cm / 10 3/4"

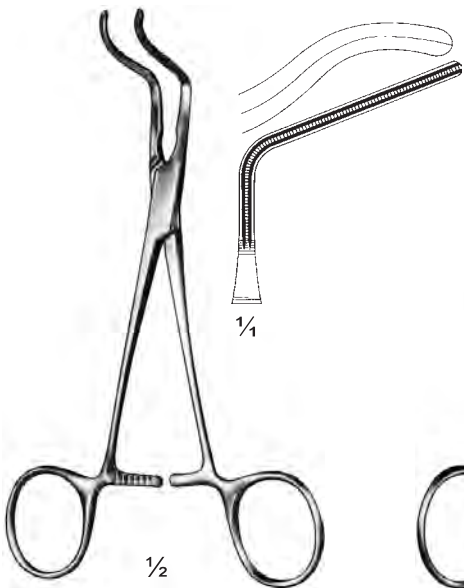

1/4

1/2

Subramanian-Miniature
837-05-15
 15 cm / 6"



1/2

Subramanian-Miniature
837-06-16 & 837-07-16
 16 cm / 6 1/4"

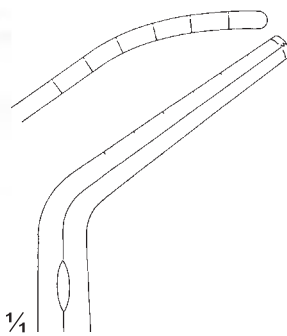

1/4

837-06-16
 Right

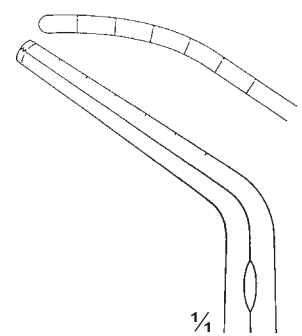

1/4

837-07-16
 Left

Kinder-Gefäßlemmen, Neonatal-Gefäßklemmen
Pediatric Vascular Clamps, Neonatal Vascular Clamps
Pinces Vasculaires pédiatriques, Pinces Vasculaires pour nouveaux nés

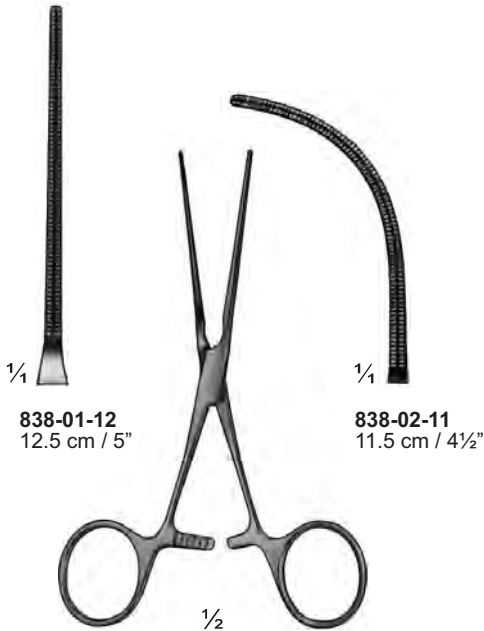

Cooley
838-01-12 To 838-02-11



Cooley
838-03-10
10 cm / 4"

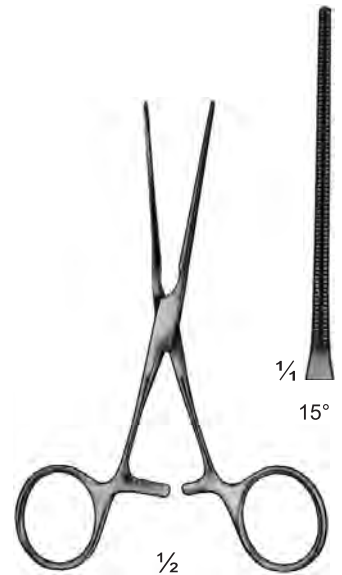

Cooley
838-04-12
12.5 cm / 5"

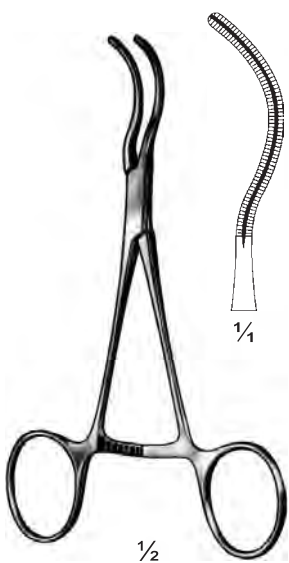

Cooley
838-05-14
14 cm / 5 1/2"

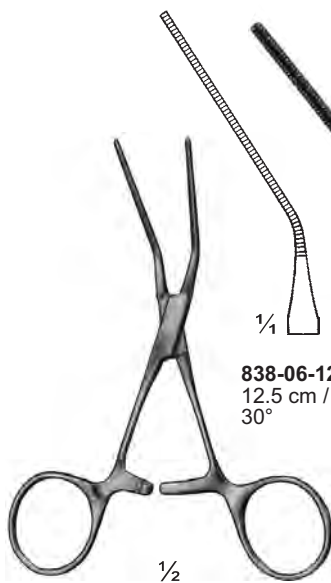

Cooley
838-06-12 To 638-09-12

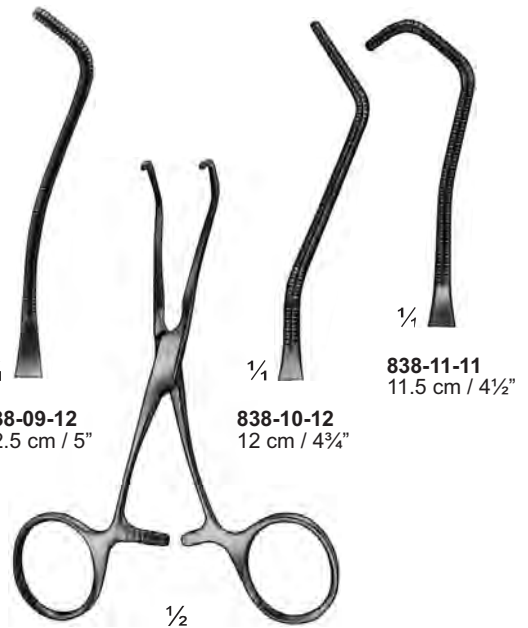

Cooley
838-10-12 To 638-11-11
Graduated

Kinder-Gefäßklemmen, Neonatal-Gefäßklemmen
Pediatric Vascular Clamps, Neonatal Vascular Clamps
Pinces Vasculaires pédiatriques, Pinces Vasculaires pour nouveaux nés



Cooley
839-01-12 To 839-03-12
 12 cm / 4³/₄"

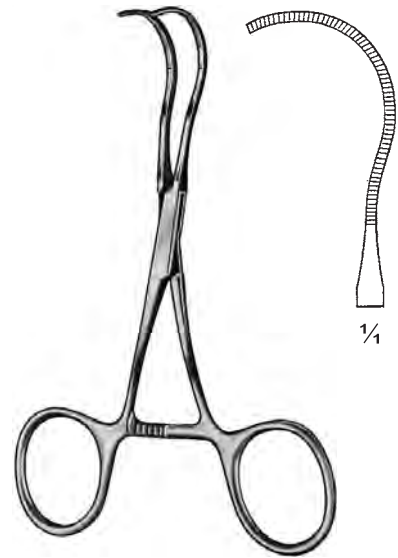
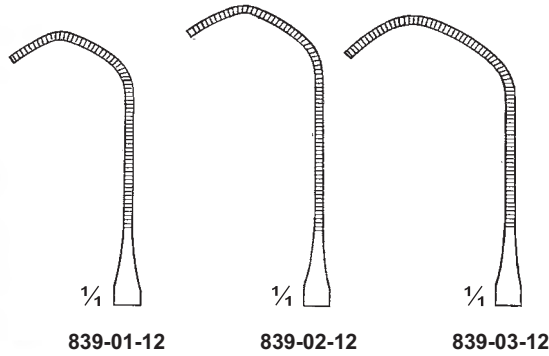

Cooley
839-04-12
 12 cm / 4³/₄"



Str Angled Cur



839-05-14 To 839-31-13

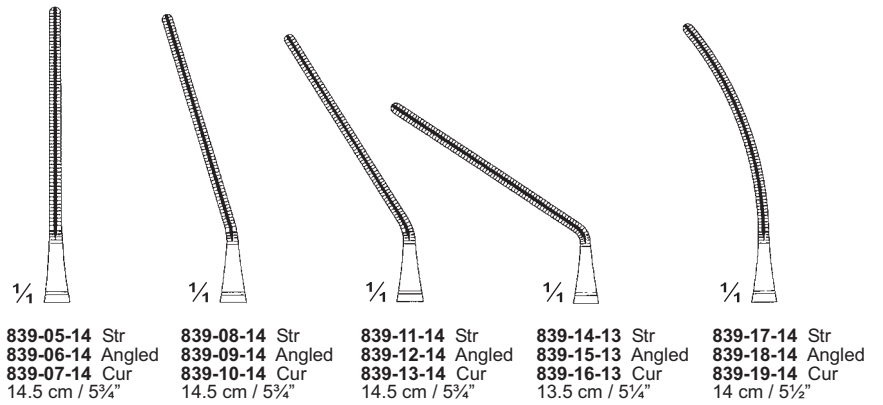

839-05-14 Str	839-08-14 Str	839-11-14 Str	839-14-13 Str	839-17-14 Str
839-06-14 Angled	839-09-14 Angled	839-12-14 Angled	839-15-13 Angled	839-18-14 Angled
839-07-14 Cur	839-10-14 Cur	839-13-14 Cur	839-16-13 Cur	839-19-14 Cur
14.5 cm / 5 ³ / ₄ "	14.5 cm / 5 ³ / ₄ "	14.5 cm / 5 ³ / ₄ "	13.5 cm / 5 ¹ / ₄ "	14 cm / 5 ¹ / ₂ "

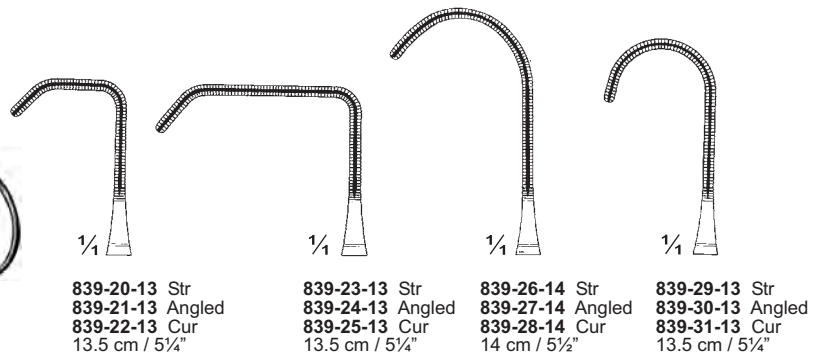

839-20-13 Str	839-23-13 Str	839-26-14 Str	839-29-13 Str
839-21-13 Angled	839-24-13 Angled	839-27-14 Angled	839-30-13 Angled
839-22-13 Cur	839-25-13 Cur	839-28-14 Cur	839-31-13 Cur
13.5 cm / 5 ¹ / ₄ "	13.5 cm / 5 ¹ / ₄ "	14 cm / 5 ¹ / ₂ "	13.5 cm / 5 ¹ / ₄ "

Kinder-Gefäßklemmen, Neonatal-Gefäßklemmen
Pediatric Vascular Clamps, Neonatal Vascular Clamps
Pinces Vasculaires pédiatriques, Pinces Vasculaires pour nouveaux nés

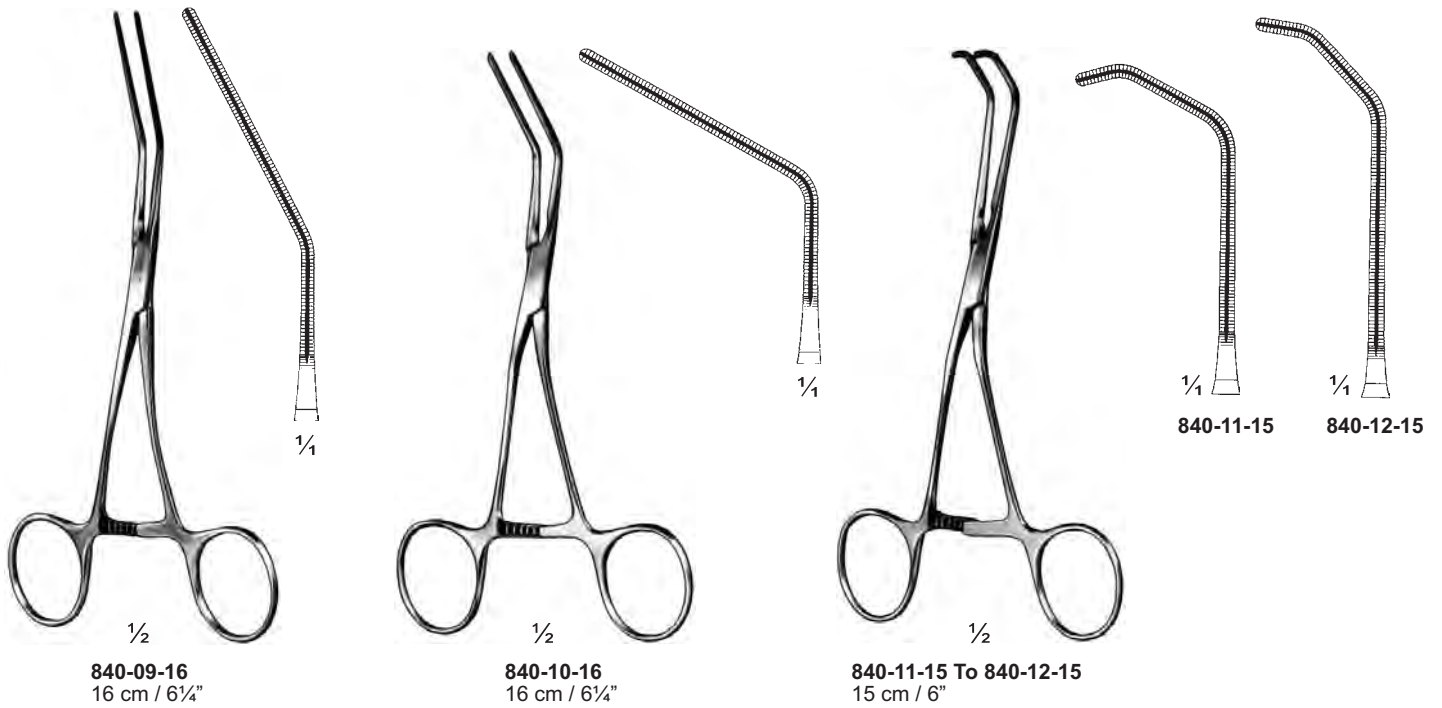
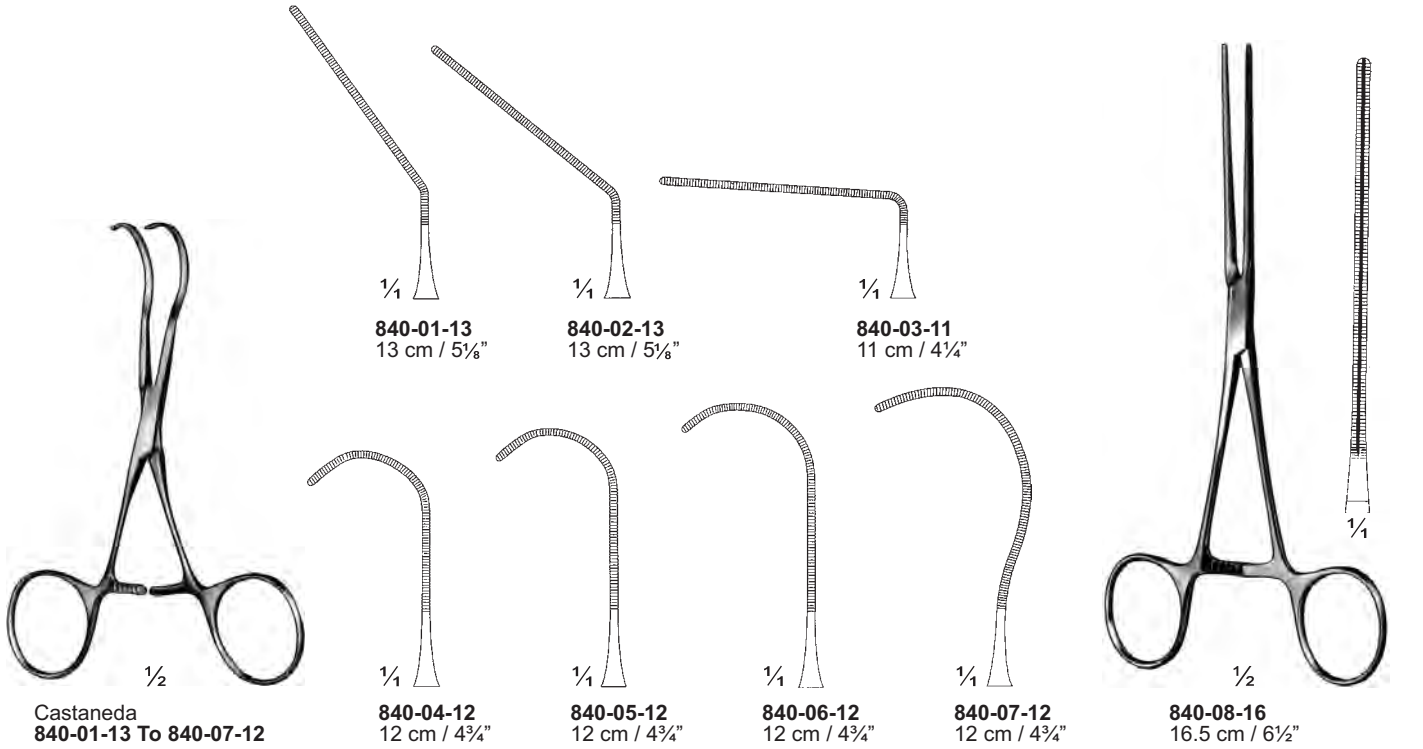

Nerv Hakt Und Aorten Klammern Fest
Nerve Hooks And Aorta Clamps
Le Nerf Accroche Et Les Serre-joint D'aorte

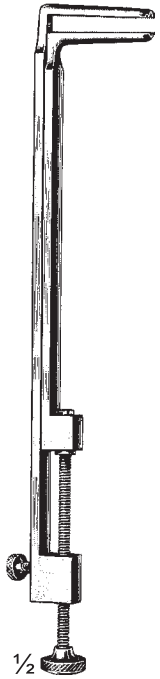

Schumaker
841-01-26 To 841-03-46
 18 cm / 7"

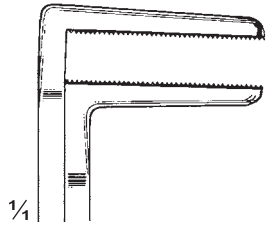

$\frac{1}{4}$
841-01-26
 26 mm

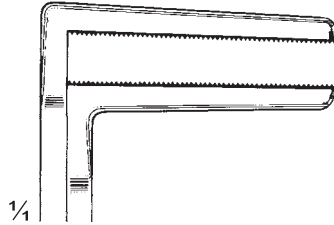

$\frac{1}{4}$
841-02-36
 36 mm

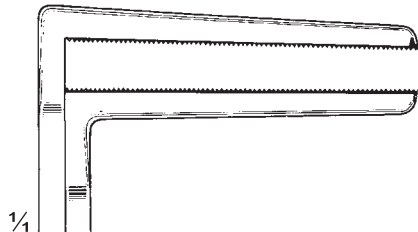

$\frac{1}{4}$
841-03-46
 46 mm



Pappen-Blalock
841-04-05 5 cm / 2"
841-05-07 7 cm / 2½"

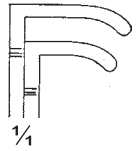

$\frac{1}{4}$

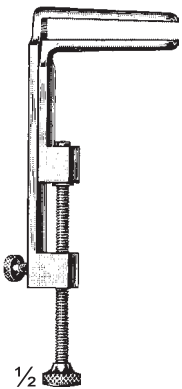

Hume
841-06-10
 10 cm / 4"

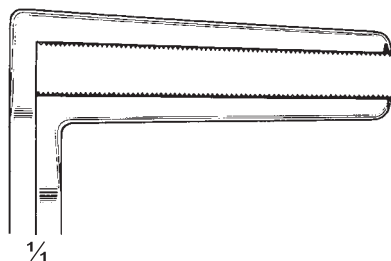

$\frac{1}{4}$

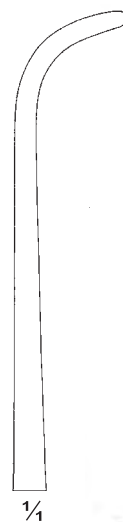

$\frac{1}{4}$



$\frac{1}{2}$

841-07-18
 18 cm / 7"
 Vascular measuring
 device

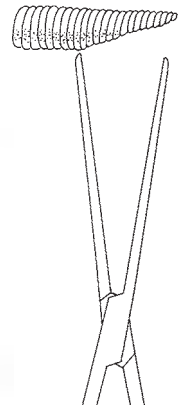

Gefäßspinzetten Vascular Forceps Pincers à dissection vasculaires

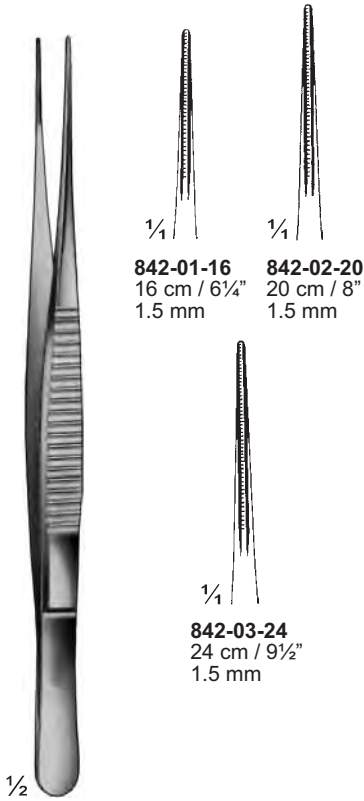

De Bakery
842-01-16 To 842-03-24

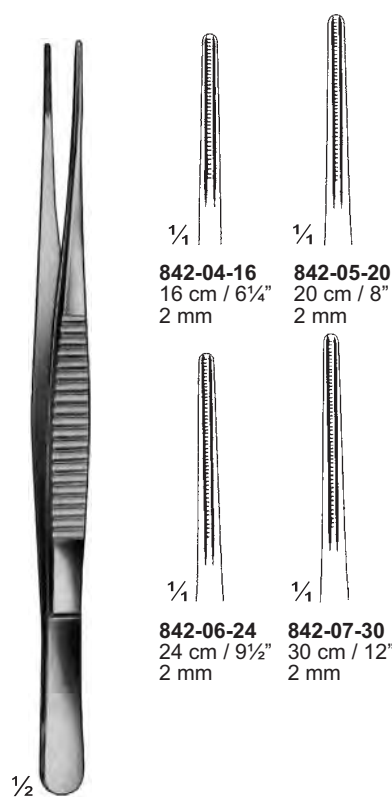

De Bakery
842-04-16 To 842-07-30

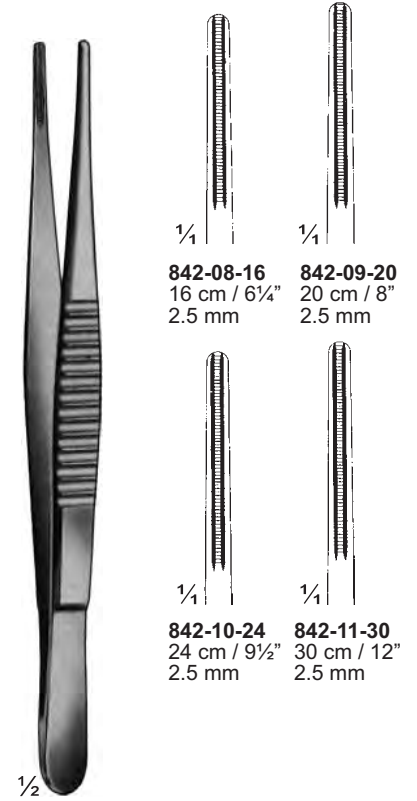

De Bakery
842-08-16 To 842-11-30

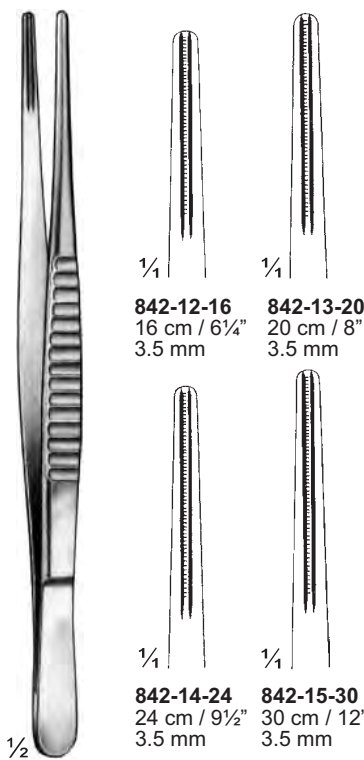

De Bakery
842-12-16 To 842-15-30

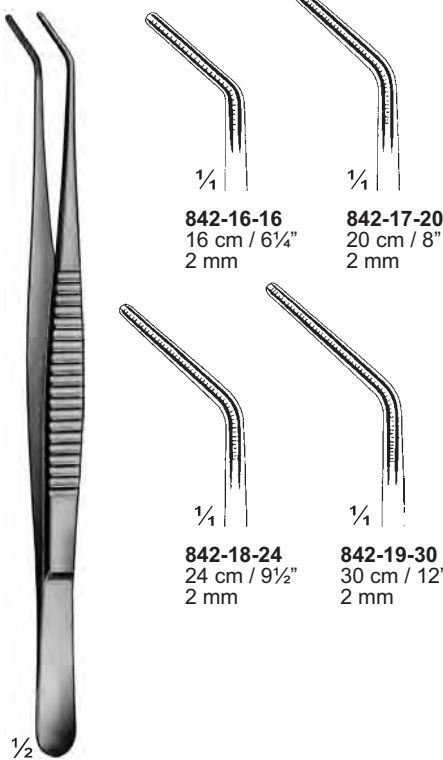

De Bakery
842-16-16 To 842-19-30

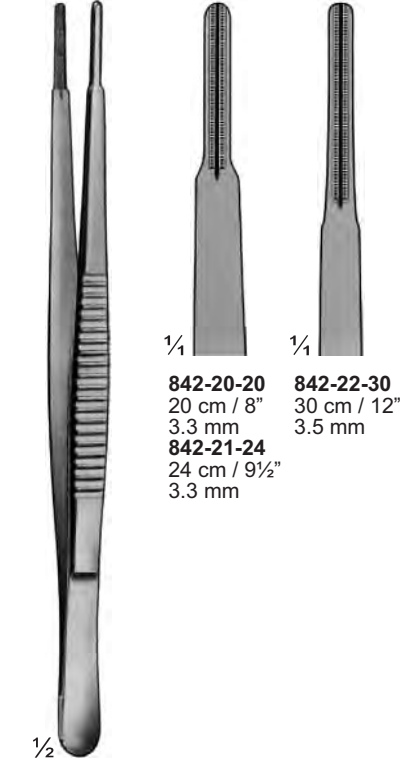

De Bakery
842-20-20 To 842-22-24

Gefäßpinzetten Vascular Forceps Pincès à dissection vasculaires



Cooley
843-01-16 16 cm / 6 1/4"
843-02-20 20 cm / 8"
843-01-15 15 cm
843-02-24 24 cm



Glassman
843-03-15 & 843-04-24

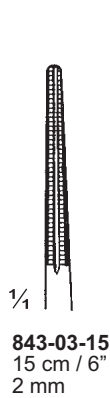

843-03-15
15 cm / 6"
2 mm

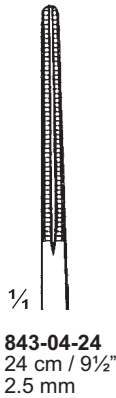

843-04-24
24 cm / 9 1/2"
2.5 mm



Glassman
843-05-24 & 843-06-24

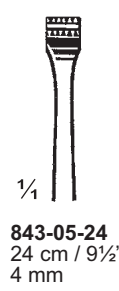

843-05-24
24 cm / 9 1/2"
4 mm

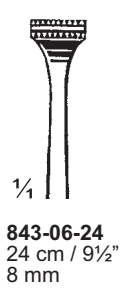

843-06-24
24 cm / 9 1/2"
8 mm

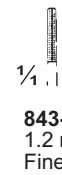

843-11-18
1.2 mm
Fine

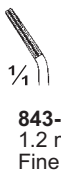

843-12-18
1.2 mm
Fine

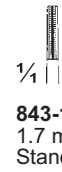

843-13-18
1.7 mm
Standard

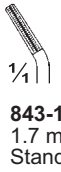

843-14-18
1.7 mm
Standard

Item No. 843-11-18 To 843-14-18
also available in Titanium

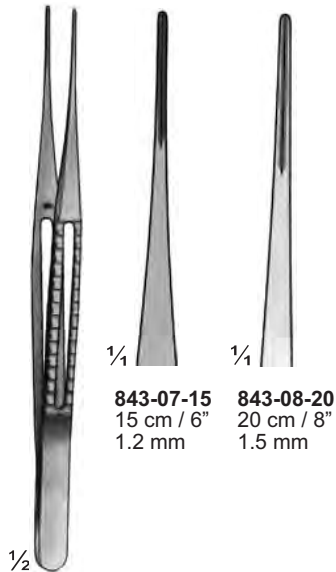

843-07-15 & 843-08-20



843-09-24 & 843-10-30

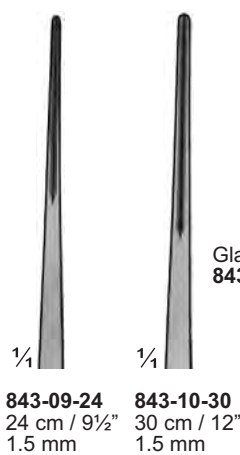

843-09-24 24 cm / 9 1/2"
1.5 mm

843-10-30 30 cm / 12"
1.5 mm



843-11-18 To 843-14-18
18 cm / 7"

**Aorta-Dilatatoren, Gefäßdilatatoren
Aortic Dilators, Vascular Dilators
Dilatateurs pour aorte, Dilatateurs vasculaires**



1/4

1/2

Tube
844-01-42
Blade opening 8 to 42 mm
For mitral valve

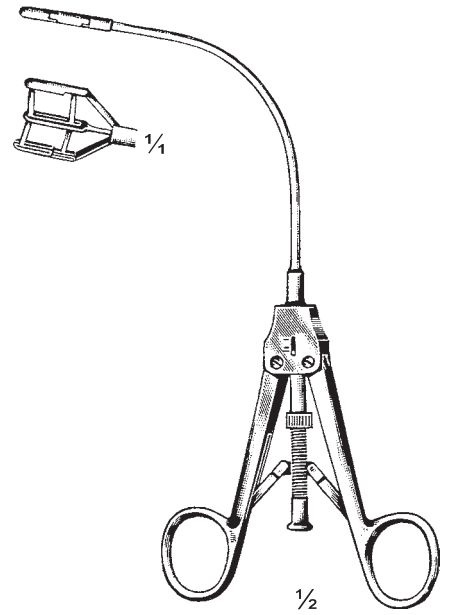

1/2

Cooley
844-02-10
Blade opening 4 to 10 mm
For children

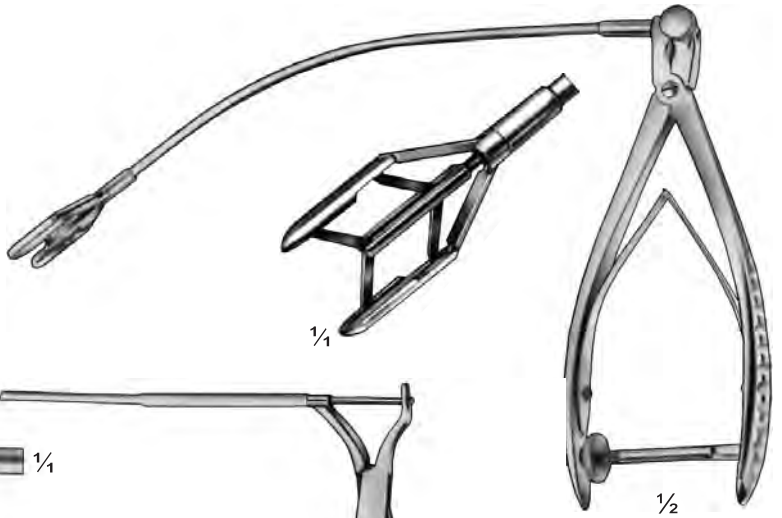

1/4

1/2

Cooley
844-03-15
Blade opening 8 to 15 mm
For mitral valve (Pediatric)

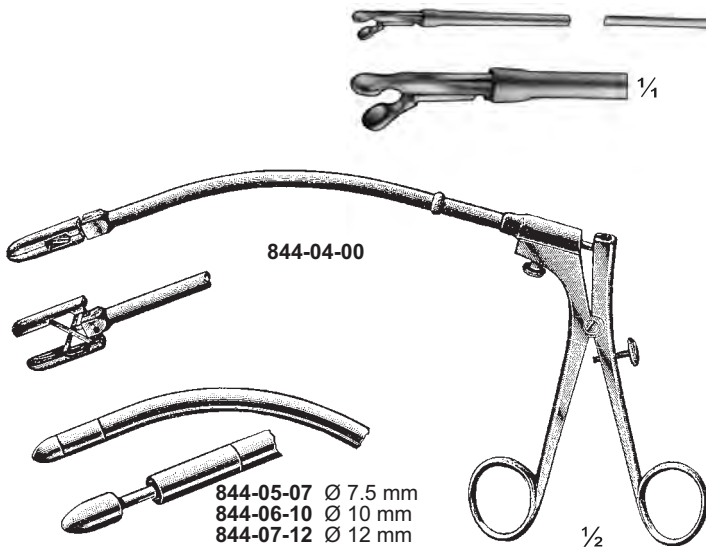

844-04-00

844-05-07 Ø 7.5 mm
844-06-10 Ø 10 mm
844-07-12 Ø 12 mm

1/2

Brock
844-04-00 To 844-07-12
844-08-04 Complete set with 4



1/2

Schulz
844-09-51
Shaft length 51 cm / 20 1/4"
Biopptome with flexible shaft, round jaws Ø 3 mm

Aorta-Dilatatoren, Gefäßdilatatoren Aortic Dilators, Vascular Dilators Dilatateurs pour aorte, Dilatateurs vasculaires

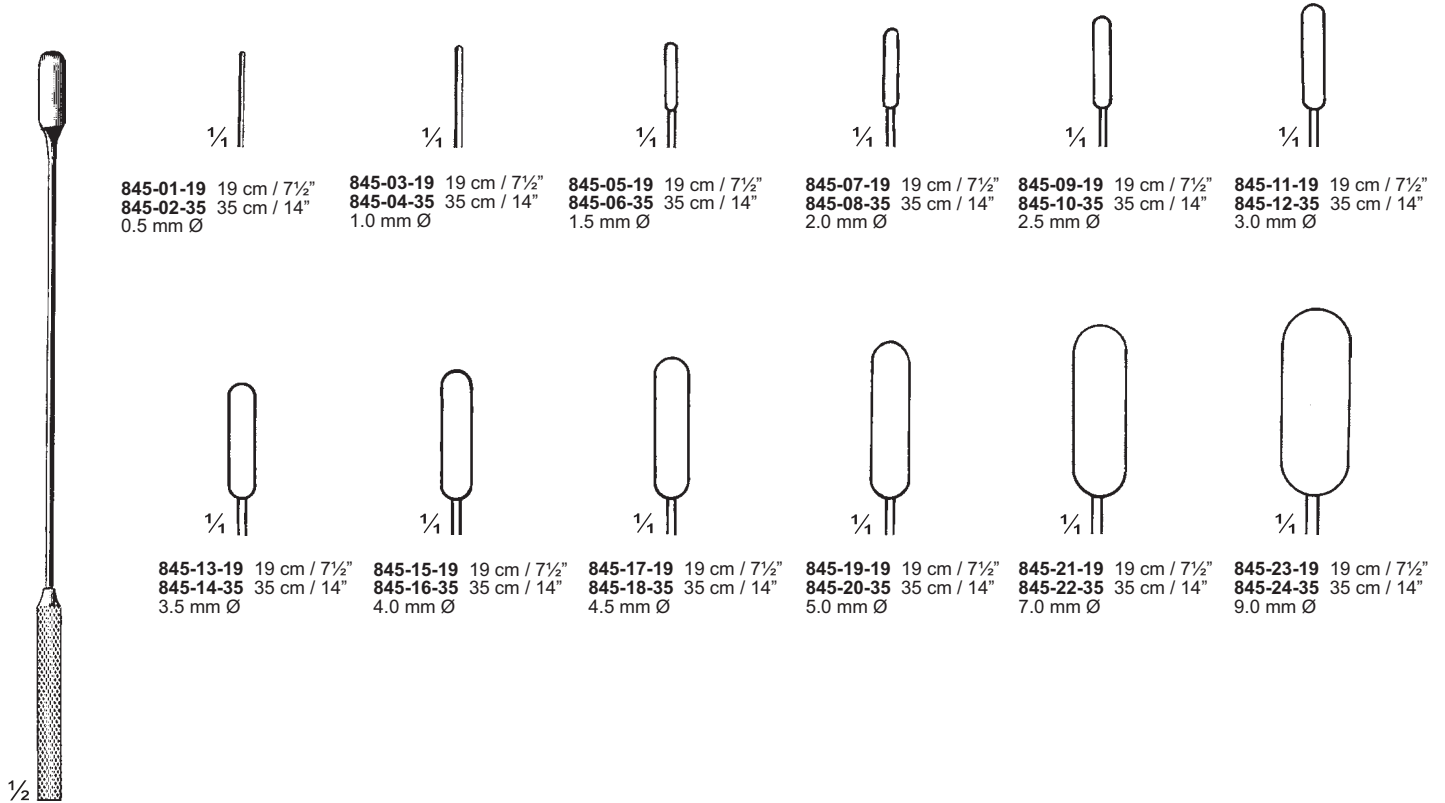

De Bakey
845-01-19 To 845-24-35
Malleable

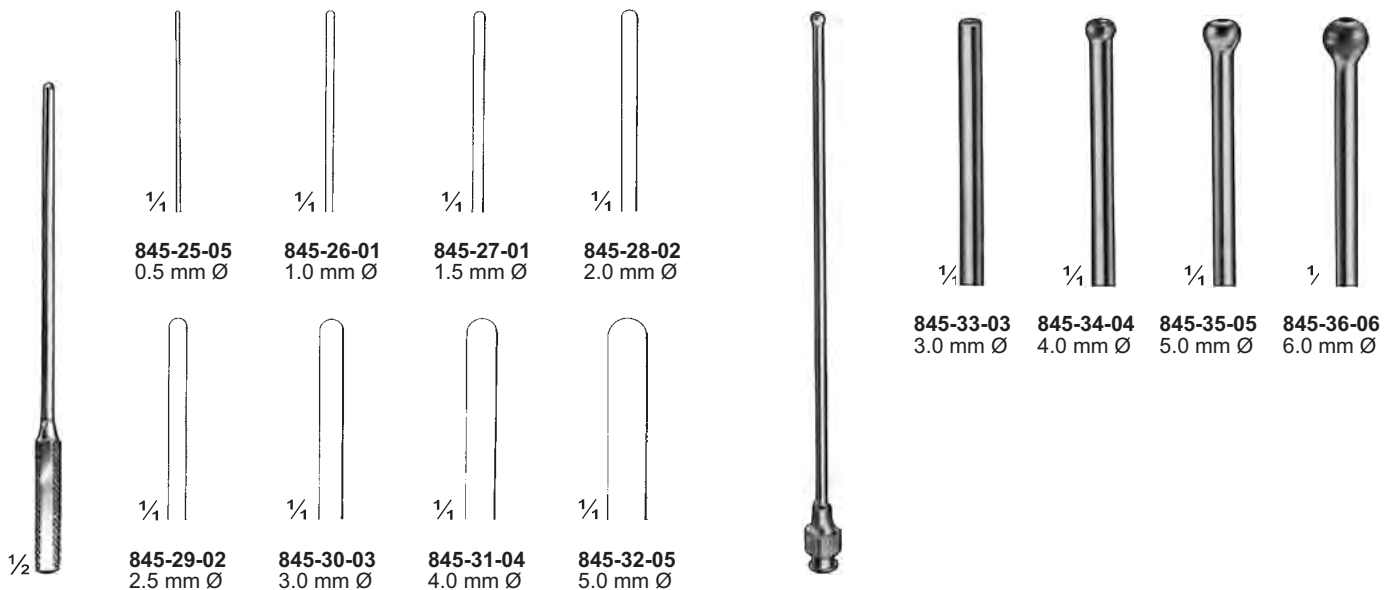

Cooley
845-25-05 To 845-32-05
13 cm / 5⅛"
Malleable

Schmid
845-33-03 To 845-36-06
15 cm / 6"
Malleable, silver plated
Vessel irrigating canulas

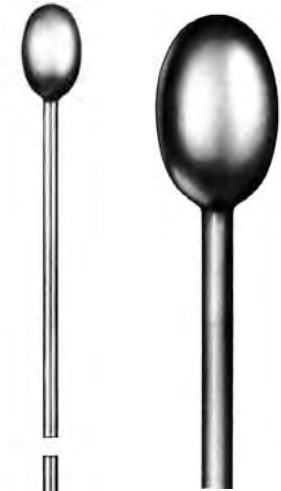

1/4



846-12-00
 Complete tunneling set

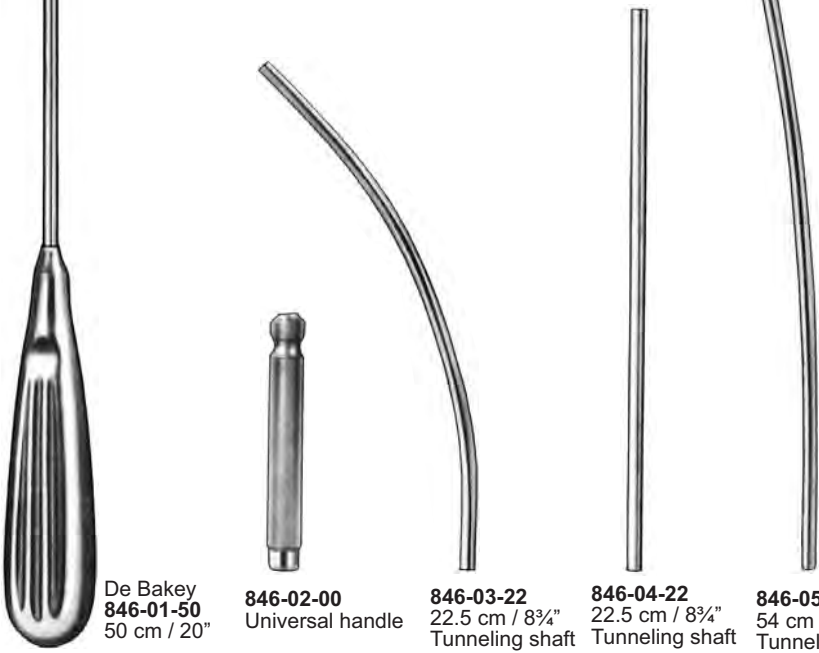

De Bakey
 846-01-50
 50 cm / 20"

846-02-00
 Universal handle

846-03-22
 22.5 cm / 8 3/4"
 Tunneling shaft

846-04-22
 22.5 cm / 8 3/4"
 Tunneling shaft

846-05-54
 54 cm / 21 1/2"
 Tunneling shaft



1/4
 846-06-06
 6 mm
 Bullet Tip

1/4
 846-07-08
 8 mm
 Bullet Tip

1/4
 846-08-10
 10 mm
 Bullet Tip

1/4
 846-09-12
 12 mm
 Bullet Tip



1/4
 846-10-00
 Vein tip



1/4
 846-11-00
 Luer Adaptor

Intimaspatel, Gefäßdissektoren Intima Spatulas, Vascular Dissectors Spatules pour la tunique interne, Dissecteurs vasculaires

847-01-18 18.5 cm / 7¼"
847-02-21 21.5 cm / 8½"

Blunt

847-03-14 14 cm / 5½"
Blunt

847-04-24 24 cm / 9½"
Blunt

847-05-25 25 cm / 10"
Intima spatula and dilator

847-06-25 25 cm / 10"
Intima spatula and dilator

847-07-25 25 cm / 10"
Intima spatula and dilator

847-08-25 25 cm / 10"
Intima spatula and dilator

847-09-02 To 847-17-14
55 cm / 22"
Endarterectomy strippers

847-18-11 11 cm / 4¼"
Handle for 847-09-02 To 847-17-14

847-09-02 2 mm

847-10-03 3 mm

847-11-04 4 mm

847-12-06 6 mm

847-13-07 7 mm

847-14-08 8.5 mm

847-15-10 10 mm



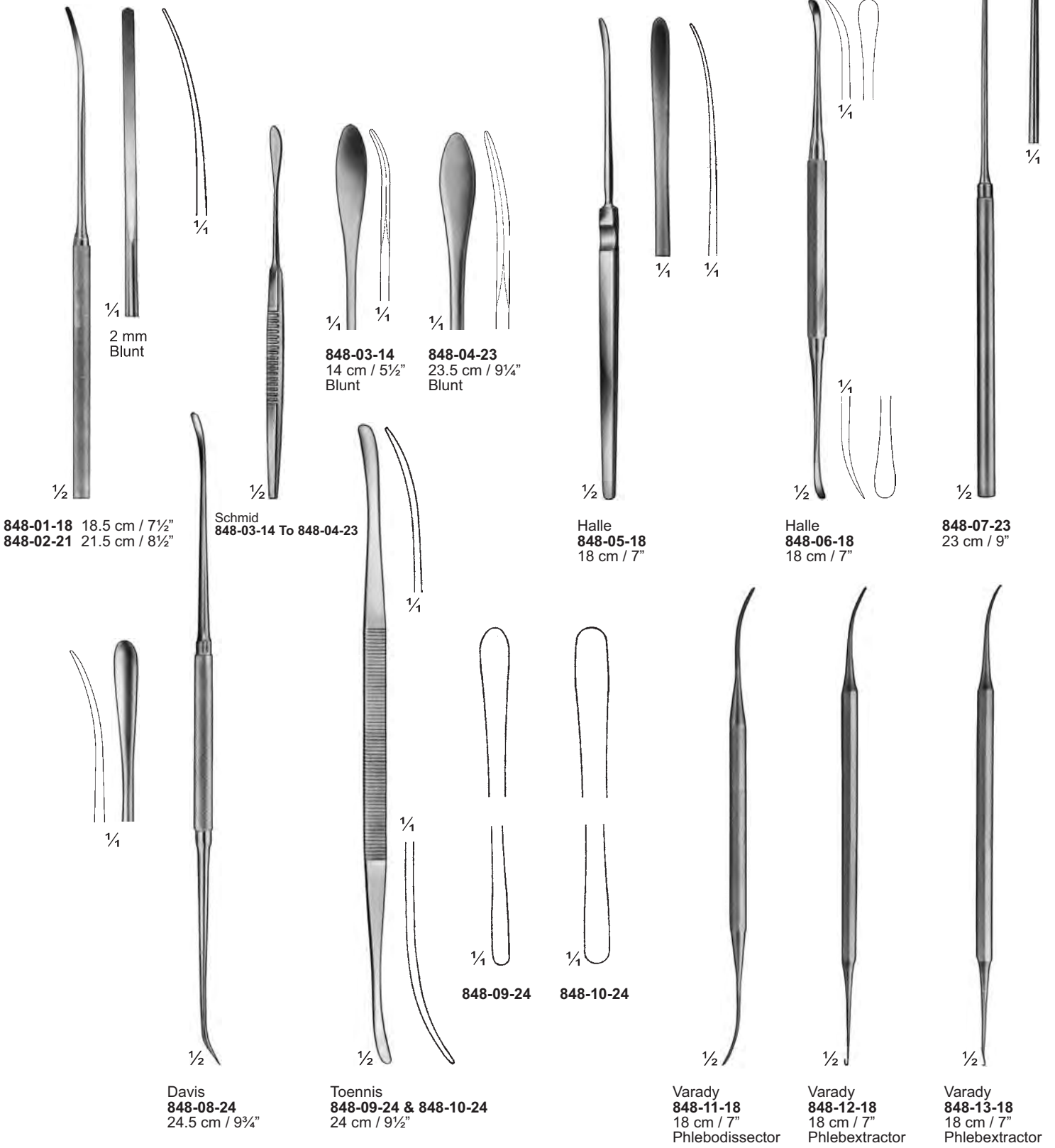

847-16-12 12 mm

847-17-14 14 mm

**Intimaspatel, Gefäßdissektoren
Intima Spatulas, Vascular Dissectors
Spatules pour la tunique interne, Dissecteurs vasculaires**

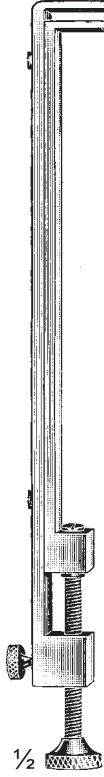
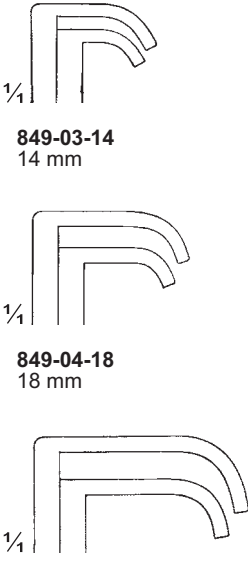
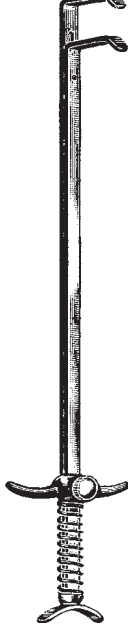
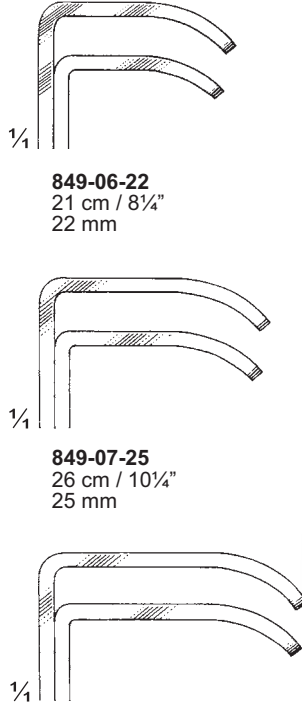

Nerv Hakt Und Aorten Klammern Fest Nerve Hooks And Aorta Clamps Le Nerf Accroche Et Les Serre-joint D'aorte

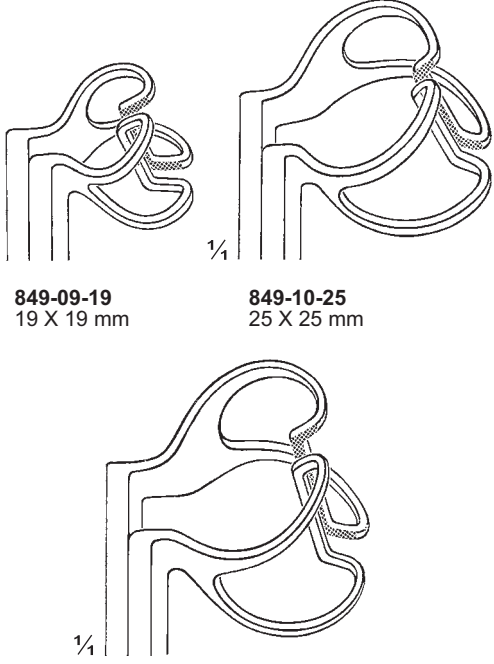
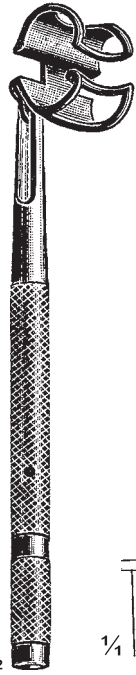
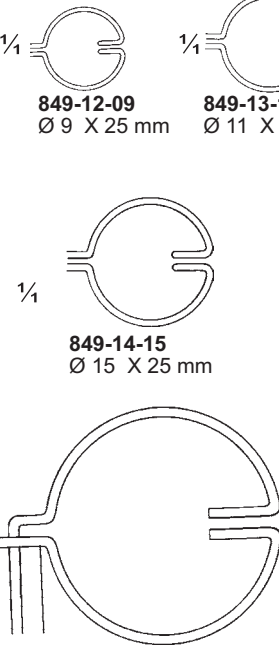
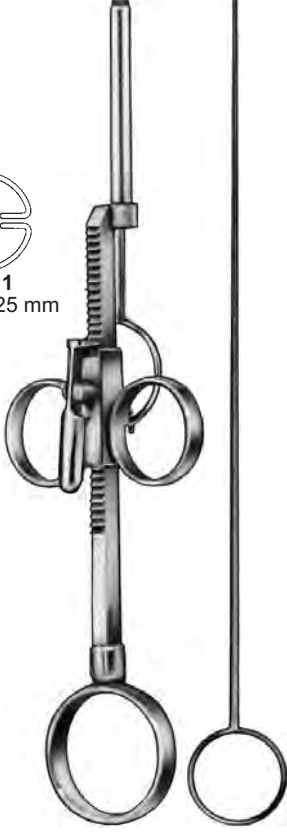
 <p style="text-align: center;">$\frac{1}{2}$</p>	 <p style="text-align: center;">$\frac{1}{4}$</p> <p style="text-align: center;">$\frac{1}{4}$</p>	 <p style="text-align: center;">$\frac{1}{2}$</p>	 <p style="text-align: center;">$\frac{1}{4}$</p> <p style="text-align: center;">$\frac{1}{4}$</p> <p style="text-align: center;">$\frac{1}{4}$</p>	 <p style="text-align: center;">$\frac{1}{2}$</p>	 <p style="text-align: center;">$\frac{1}{4}$</p> <p style="text-align: center;">$\frac{1}{4}$</p> <p style="text-align: center;">$\frac{1}{4}$</p>	 <p style="text-align: center;">$\frac{1}{4}$ $\frac{1}{4}$</p>
<p>Crile 849-01-20 To 849-02-20 20 cm / 8"</p>		<p>Blalock 849-03-14 To 849-05-23 20 cm / 8"</p>		<p>Blalock 849-06-22 To 849-08-32 26 cm / 10$\frac{1}{4}$" 32 mm</p>		
 <p style="text-align: center;">$\frac{1}{2}$</p>	 <p style="text-align: center;">$\frac{1}{4}$</p> <p style="text-align: center;">$\frac{1}{4}$</p> <p style="text-align: center;">$\frac{1}{4}$</p>	 <p style="text-align: center;">$\frac{1}{2}$</p>	 <p style="text-align: center;">$\frac{1}{4}$</p> <p style="text-align: center;">$\frac{1}{4}$</p> <p style="text-align: center;">$\frac{1}{4}$</p> <p style="text-align: center;">$\frac{1}{4}$</p>	 <p style="text-align: center;">$\frac{1}{4}$</p>		
<p>Pott (Johns-Hopkins) 849-09-19 To 849-11-32 20 cm / 8"</p>	<p>849-09-19 19 X 19 mm</p> <p>849-10-25 25 X 25 mm</p> <p>849-11-32 32 X 32 mm</p>	<p>Potts-Smith 849-12-09 To 849-15-28 18 cm / 7"</p>	<p>849-12-09 Ø 9 X 25 mm</p> <p>849-13-11 Ø 11 X 25 mm</p> <p>849-14-15 Ø 15 X 25 mm</p> <p>849-15-28 Ø 28 X 35 mm</p>	<p>Rumel-Belmont 849-16-04 Ø 4 mm 849-17-06 Ø 6.4 mm 33 cm / 13" With one pair of guide</p>		



Blake
850-01-20
 20 cm / 8"

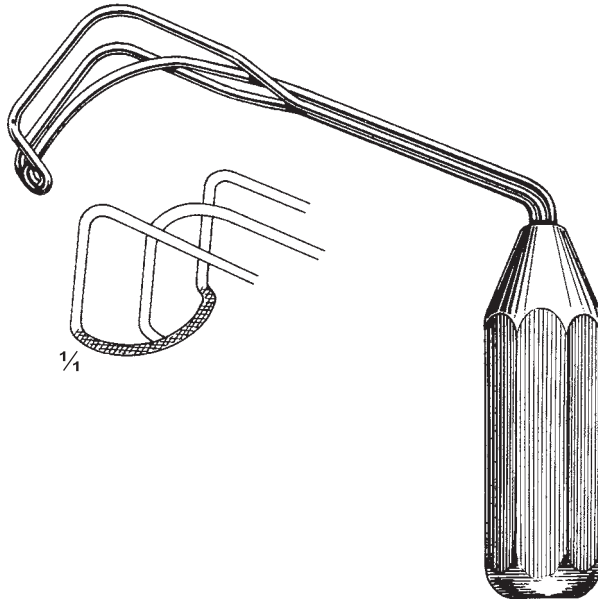

Cooley
850-02-21
 21.5 cm / 8 1/4"

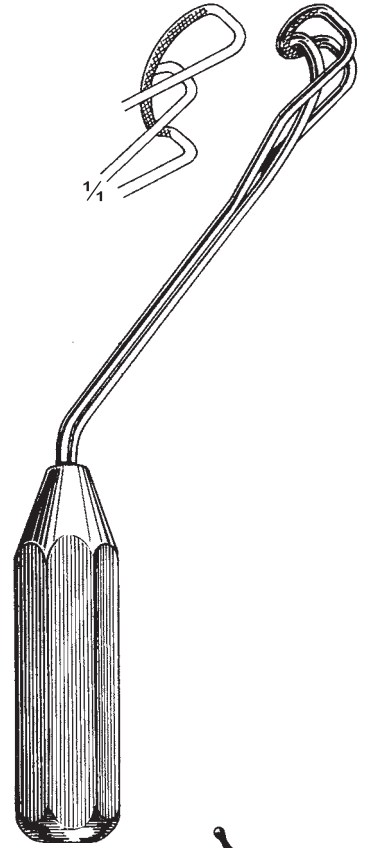

Cooley
850-03-23
 23 cm / 9"

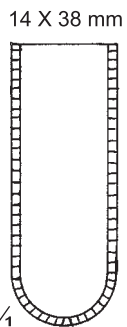
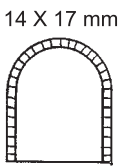

850-04-20

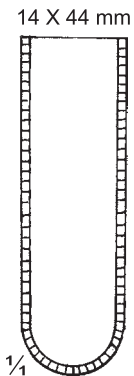
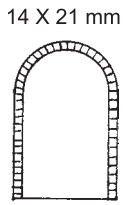

850-05-20



Cooley
850-04-20 & 850-05-20
 20 cm / 8"



Brock
850-06-05
 27 cm / 10 1/2"
 Ø 5 mm



Brock
850-07-06
 27 cm / 10 1/2"
 6 mm



Brock
850-08-07 7.5 mm
850-09-10 10 mm
850-10-12 12 mm
 27 cm / 10 1/2"

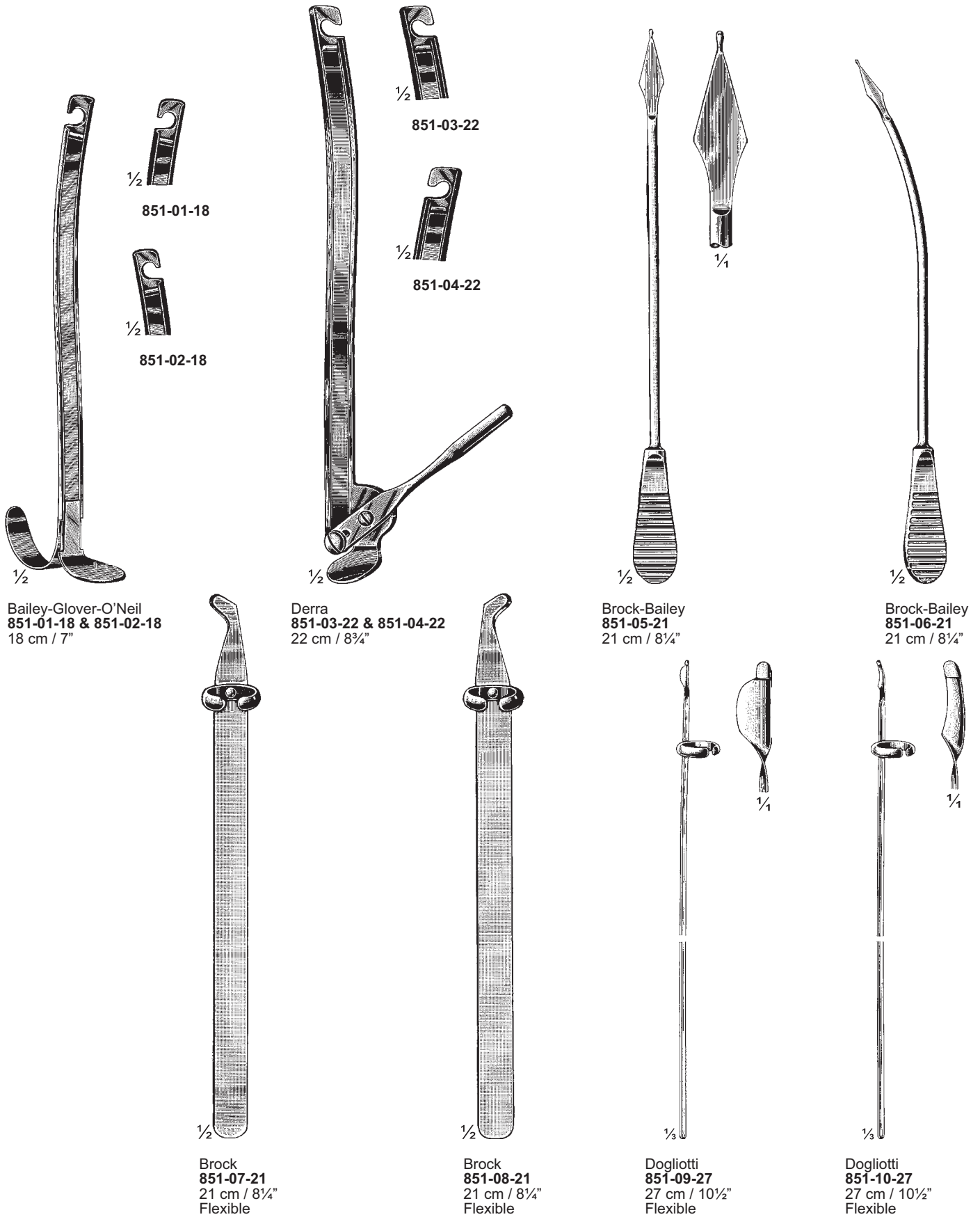

**Gefäss Klammert Fest
Vessel Clamps
Le Vaisseau Serre**

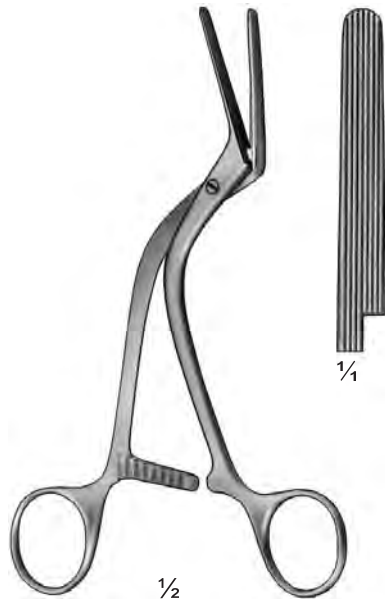

$\frac{1}{2}$
Hopfner
852-01-16
16 cm / 6 $\frac{1}{4}$ "



Baby-Satinsky
852-02-15
15 cm / 6"



$\frac{1}{2}$
Satinsky
852-03-26 & 852-04-26
26.5 cm / 10 $\frac{1}{2}$ "

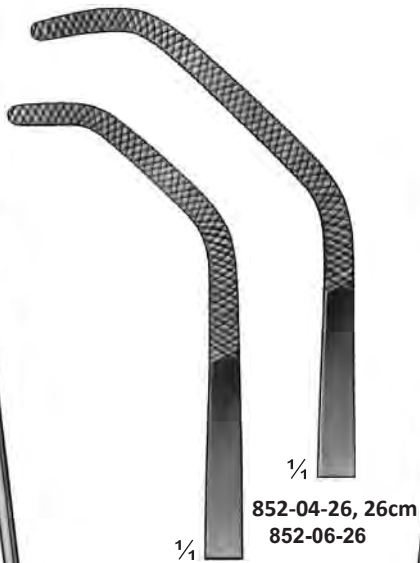

$\frac{1}{4}$
852-03-24, 24 cm
852-03-26
852-05-26

$\frac{1}{4}$
852-04-26, 26cm
852-06-26

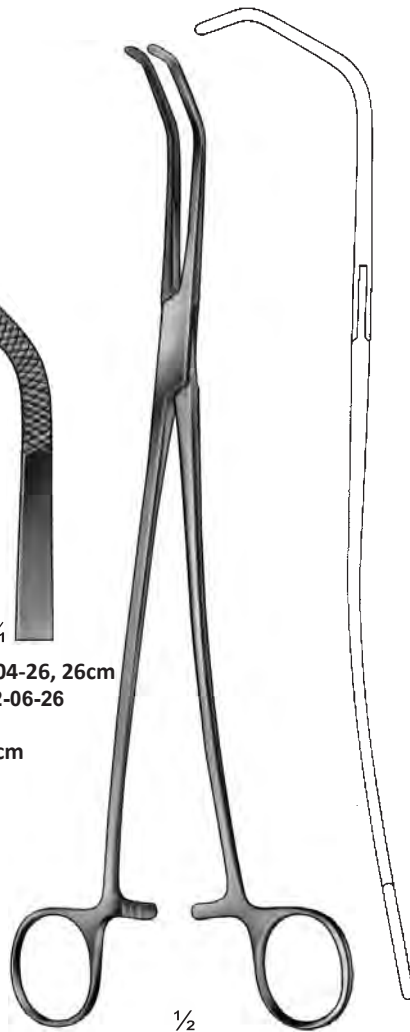

$\frac{1}{2}$
Satinsky
852-05-26 & 852-06-26
26.5 cm / 10 $\frac{1}{2}$ "

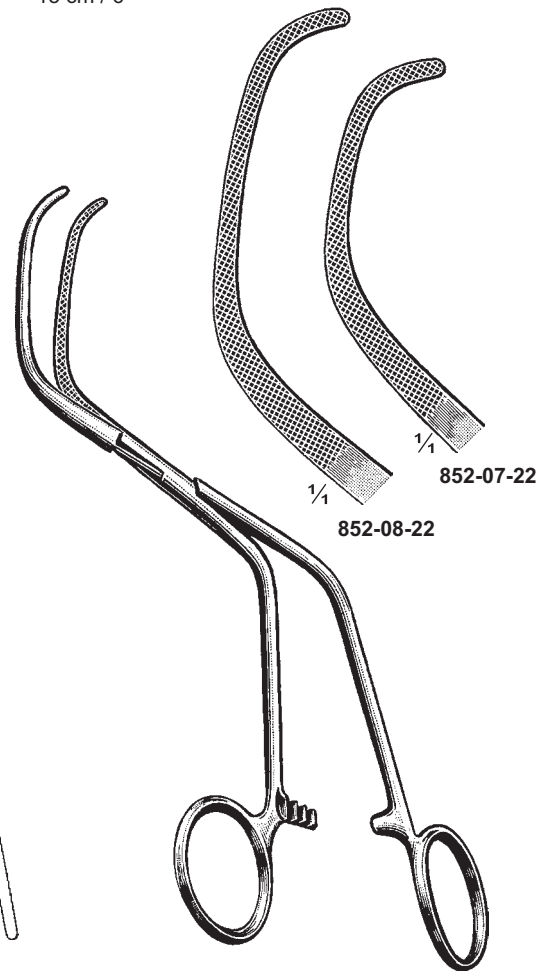

$\frac{1}{4}$
852-07-22
852-08-22
 $\frac{1}{4}$
Potts-Satinsky
852-07-22 & 852-08-22
22 cm / 8 $\frac{3}{4}$ "

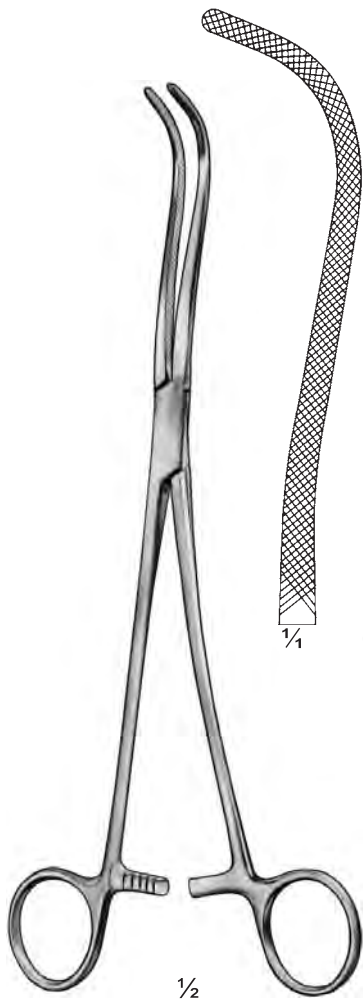

$\frac{1}{2}$
Harken
853-01-24
24 cm / 9½"



$\frac{1}{4}$

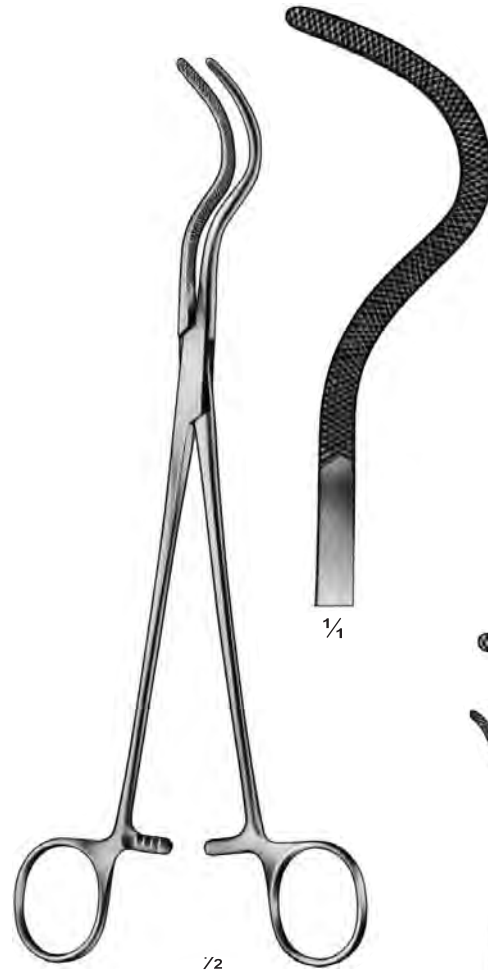

$\frac{1}{2}$
Harken
853-02-24
24 cm / 9½"



$\frac{1}{2}$
Harken
853-03-24
24 cm / 9½"



Item No. 853-03-24 & 853-04-24
can be use together

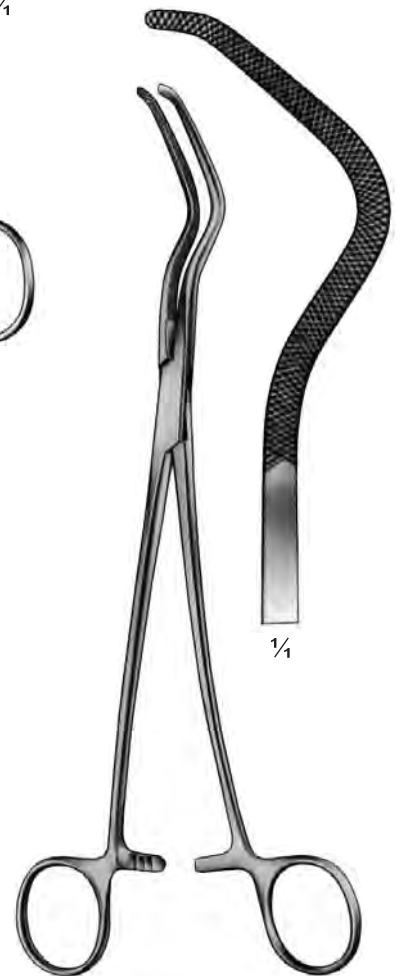

$\frac{1}{4}$
Harken
853-04-24
24 cm / 9½"

Gefäß Klammert Fest
Vessel Clamps
Le Vaisseau Serre

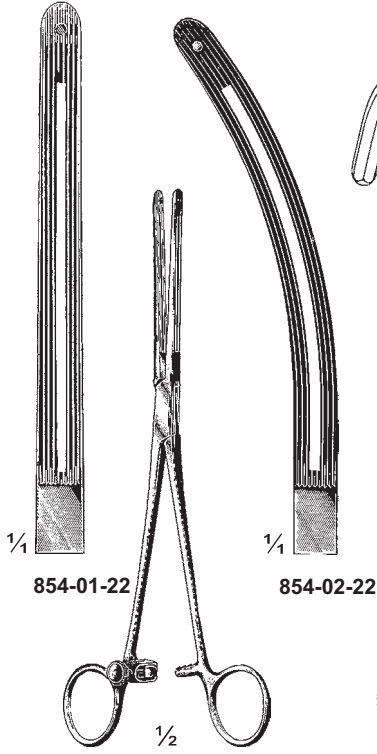

854-01-22 854-02-22

Johns-Hopkins
 854-01-22 & 854-02-22
 22 cm / 8³/₄"

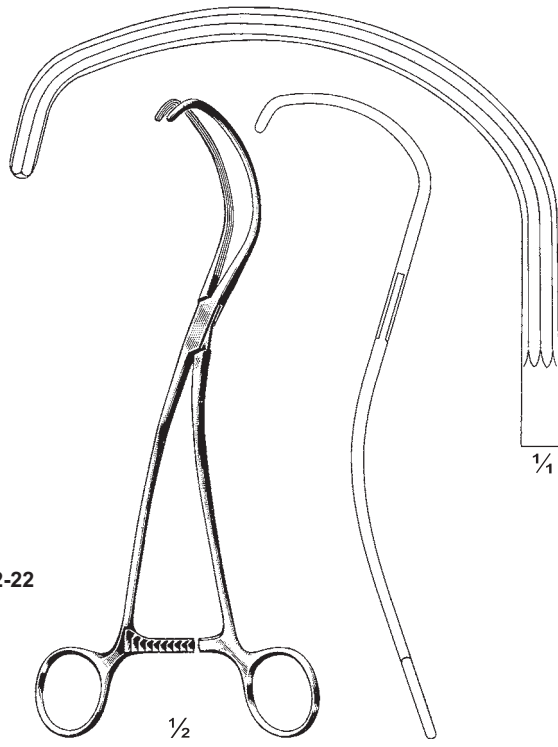

Derra
 854-03-24
 24 cm / 9¹/₂"

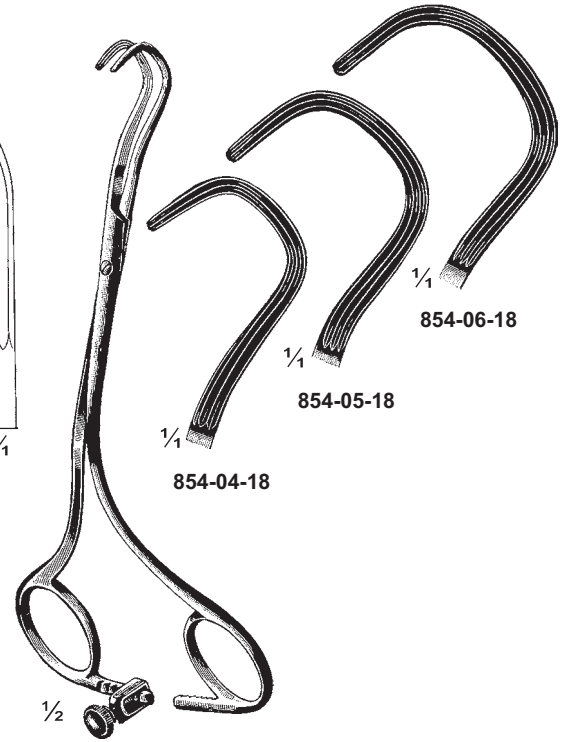

Derra
 854-04-18 To 854-06-18
 18 cm / 7"

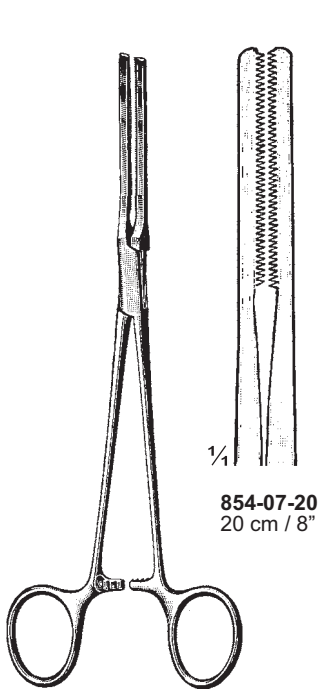

854-07-20
 20 cm / 8"

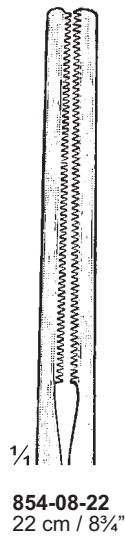

854-08-22
 22 cm / 8³/₄"

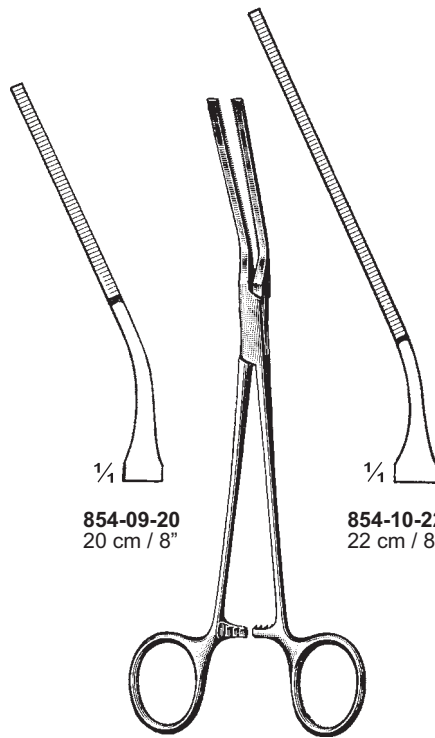

854-09-20
 20 cm / 8"

854-10-22
 22 cm / 8³/₄"

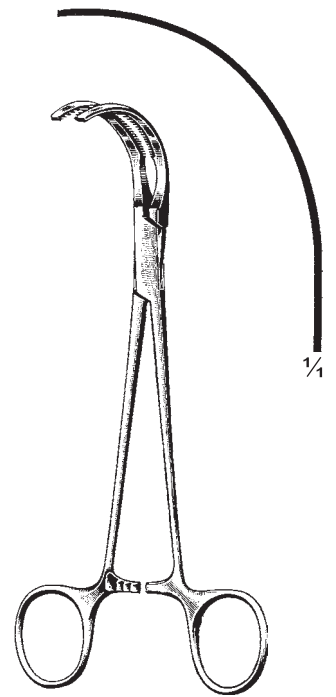

Potts-Glover
 854-11-21
 21 cm / 8¹/₄"

Potts
 854-07-20 & 854-08-22

Potts
 854-09-20 & 854-10-22

Gefäß Klammert Fest
Vessel Clamps
Le Vaisseau Serre

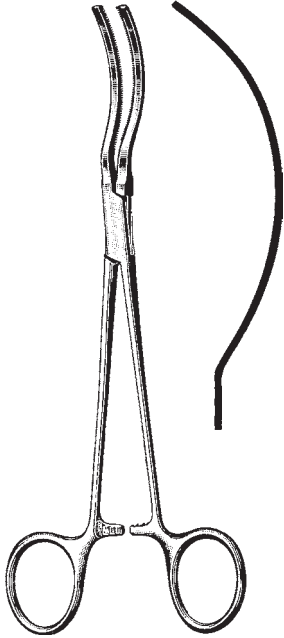

Potts-Glover
855-01-22
 22 cm / 8¾"

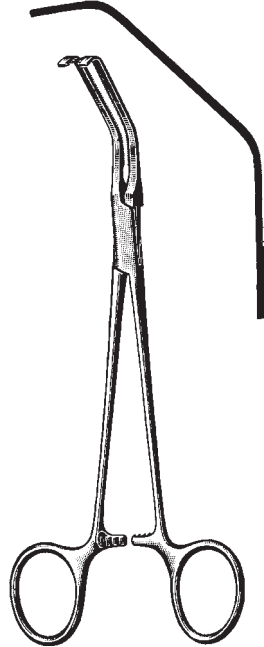

Potts-Satinsky
855-02-21
 21 cm / 8¼"



1/2
 Pertuiset
855-03-09
 9 cm / 3½"
 Catroid clamp



1/2
855-04-18 To 855-05-18
 18.5 cm / 7¼"



855-04-18
 Sh/Probe, 125°



855-05-18
 Sh/Sh, 125°

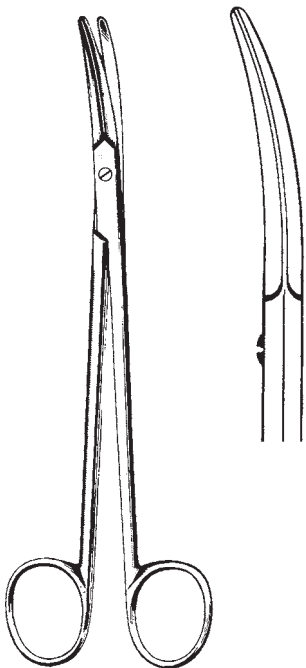

Potts-Smith
855-06-18
 18 cm / 7"

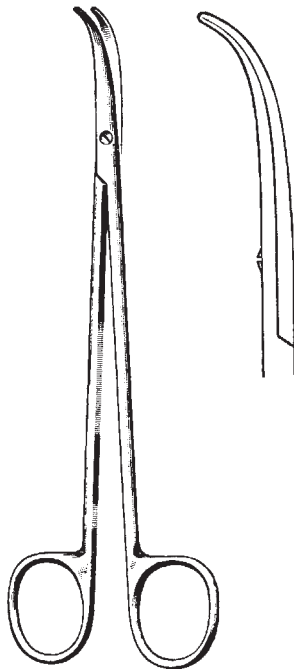

De Bakey
855-07-18
 18 cm / 7"

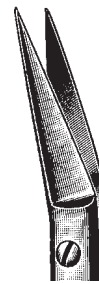

855-08-19
 Sh/Sh

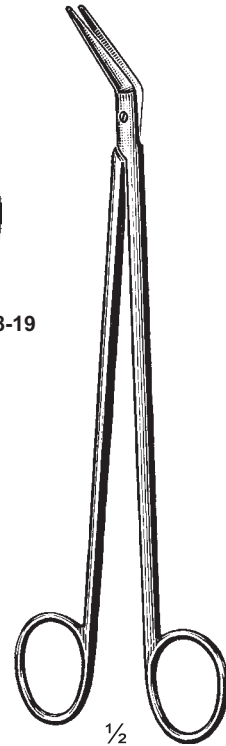

1/2
 Potts-Smith
855-08-19 & 855-09-19
 19 cm / 7½"

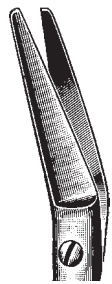

855-09-19
 BI/BI

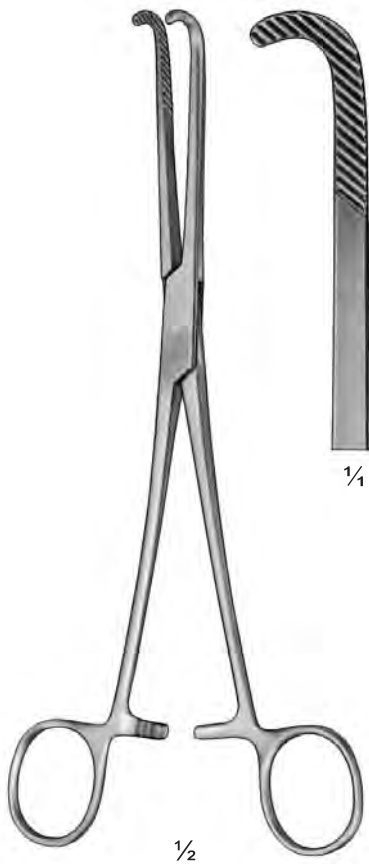

Nissen
856-01-21
 21 cm / 8 1/4"



Hosemann
856-02-21 & 856-03-21
 21.5 cm / 8 1/2"

1/4 **856-02-21**
 1/4 **856-03-21**
 1 X 2 Teeth

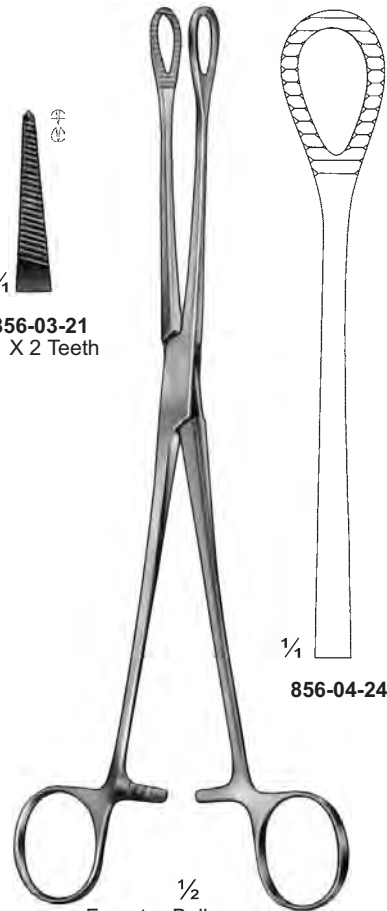

Foerster-Ballenger
856-04-24 & 856-05-24
 24 cm / 9 1/2"

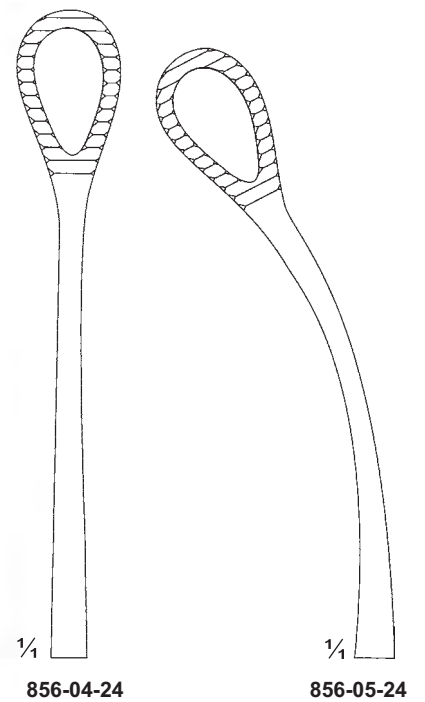

856-05-24

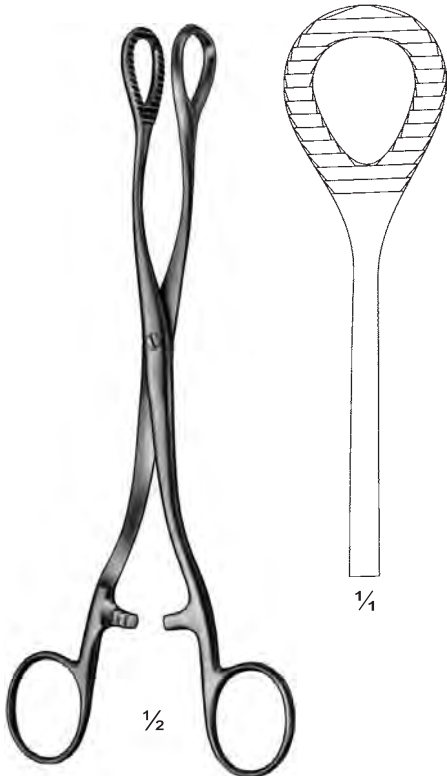

Heywood-Smith
856-06-20
 20 cm / 8"

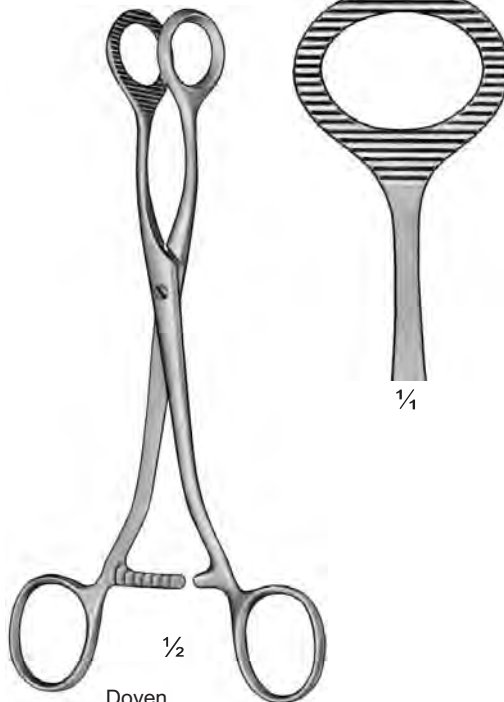

Doyen
856-07-18
 18.5 cm / 8 1/4"

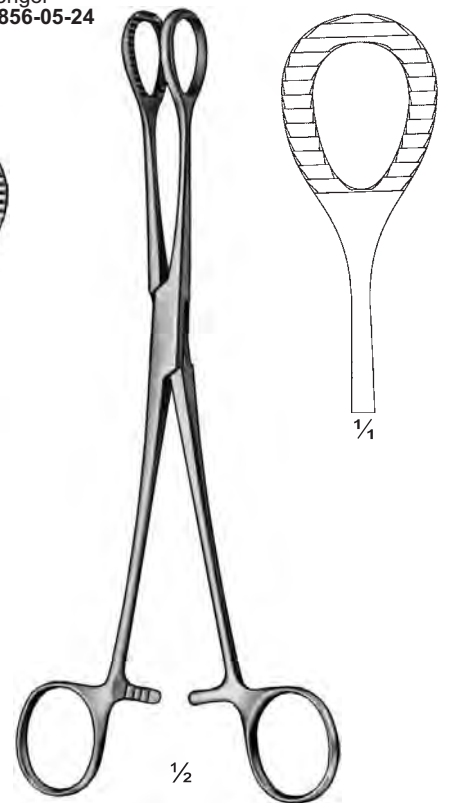

Heywood-Smith modif.
856-08-21
 21.5 cm / 8 1/2"

Ärgern Sie Leitung Zange
 Gall Duct Froceps
 Les Forceps De Conduit De Bile

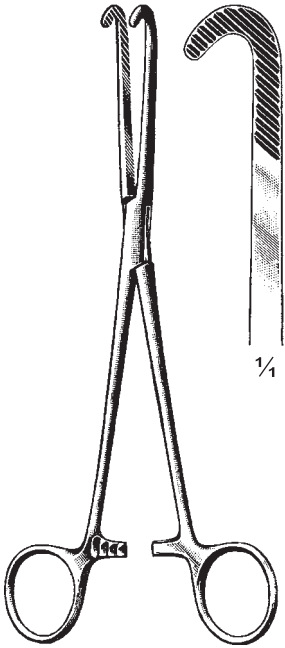

Bergstroem
 857-01-21
 21 cm / 8¼"

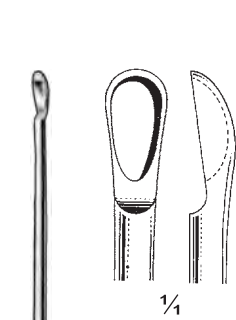

Moynihan
 857-02-34
 34 cm / 13½"
 Malleable

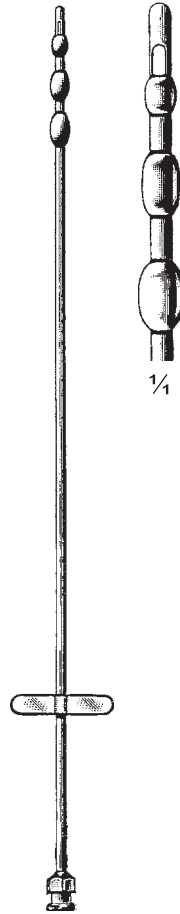

Mixer
 857-03-30
 30 cm / 12"



Hajek
 857-04-16
 16.5 cm / 6½"



Desjardins
 857-05-28 To 857-10-28
 28 cm / 11"
 Elastic

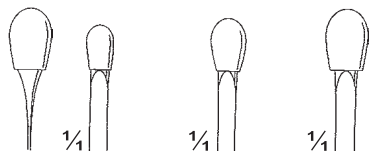

857-05-28 857-06-28 857-07-28



857-08-28 857-09-28 857-10-28



Mayo
 857-11-33
 33 cm / 13"
 Malleable

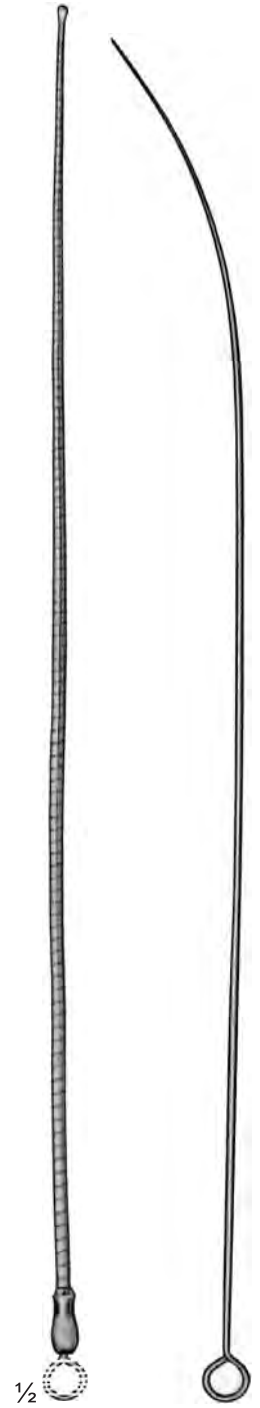

Ochsner
 857-12-40
 40cm / 16"
 Flexible

Gallensteinzangen
Gall Stone Forceps
Pinces pour calculs biliaires

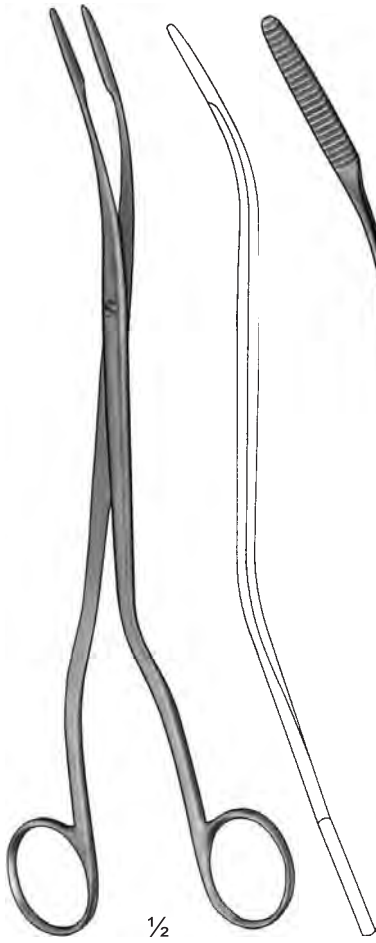

Czerny
858-01-24
 24.5 cm / 9³/₄"

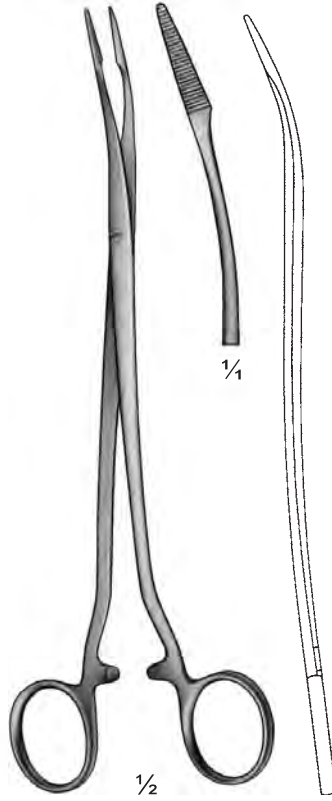

858-02-21
 21 cm / 8¹/₄"



Mixer
858-03-22
 22 cm / 8³/₄"



858-04-23



858-05-23



858-06-23



858-07-23



Desjardins
858-04-23 To 858-07-23
 23 cm / 9"

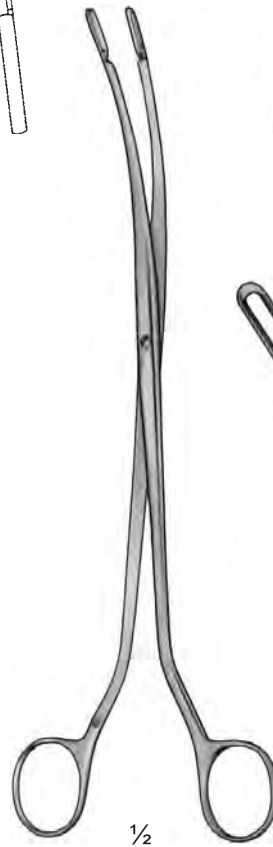

Desjardins
858-08-24 To 858-09-23
 Extremely delicate



858-08-24
 24 cm / 9¹/₂"

858-09-23
 23 cm / 9"

Gallensteinzangen
Gall Stone Forceps
Pinces pour calculs biliaires

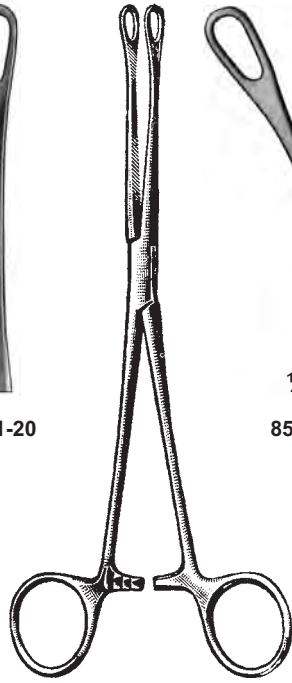
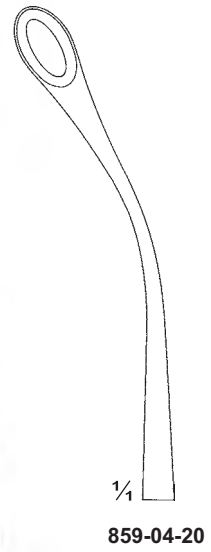
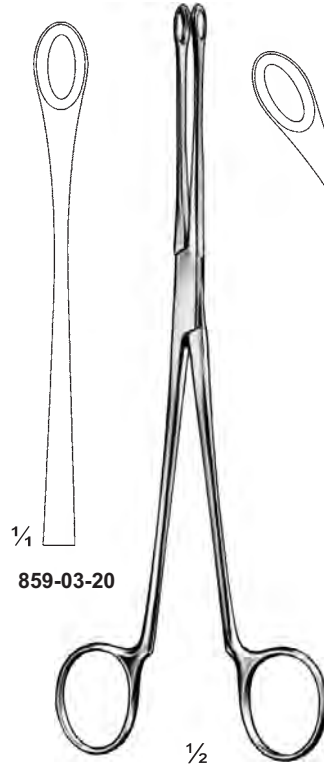

Blake
859-03-20 & 859-04-20
20 cm / 8"

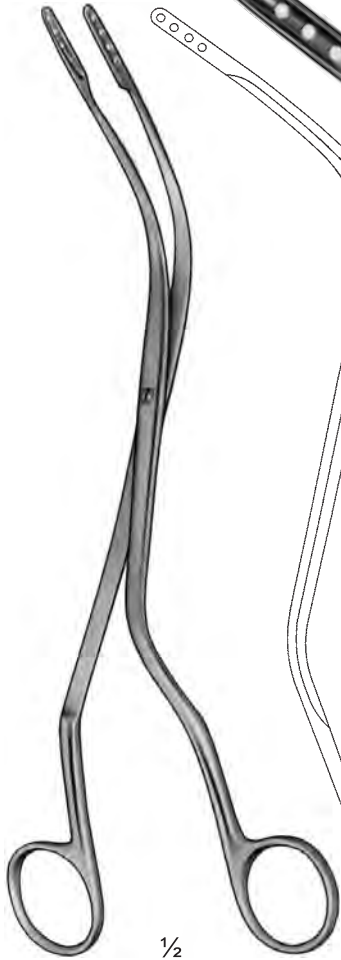
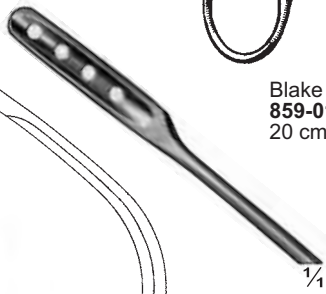

Tubinger Modell
859-05-25
25 cm / 10"

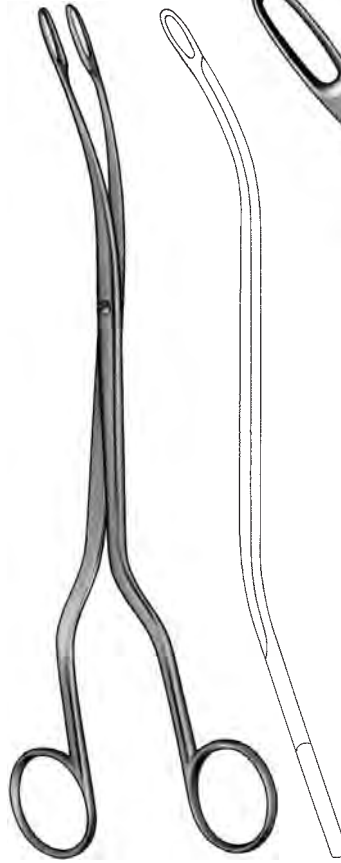

Stille
859-06-24
24.5 cm / 9 3/4"



Pelkmann
859-07-26
26 cm / 10 1/4"

Gallensteinzangen
Gall Stone Forceps
Pinces pour calculs biliaires

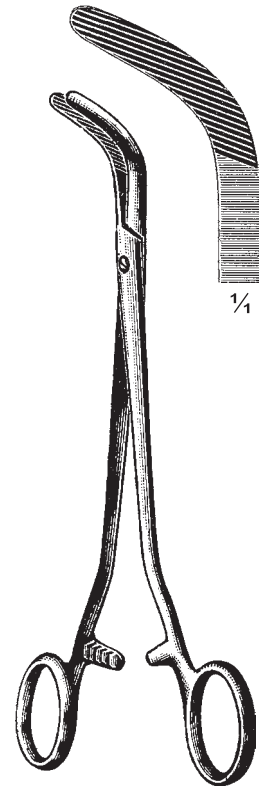
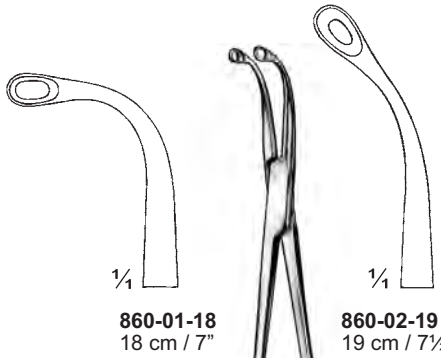

Turner-Warwick
860-01-18 & 860-02-19

Mayo-Blake
860-03-20
 20 cm / 8"

Mayo-Blake
860-04-20
 20 cm / 8"

Crile
860-05-21
 21 cm / 8¼"

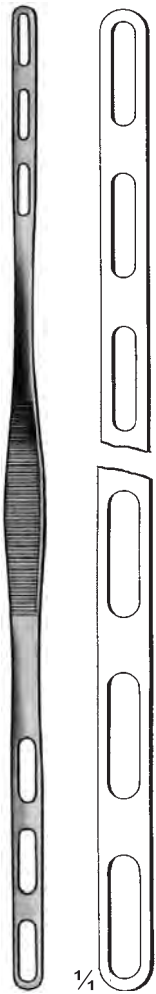

860-06-27
 27 cm / 10½"
 Malleable

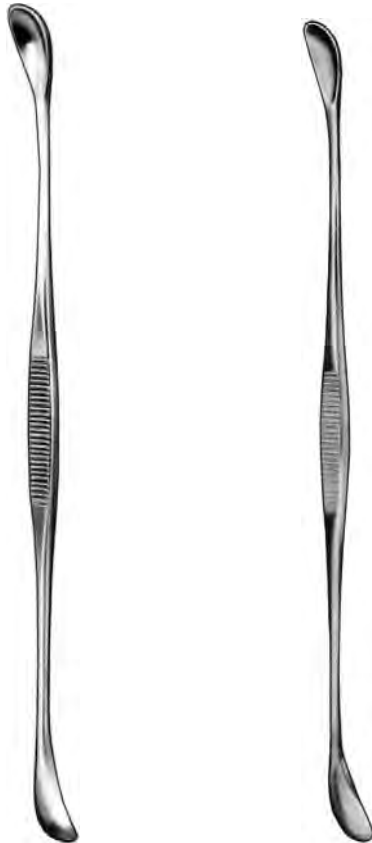

Mayo
860-07-28
 28 cm / 11"



Fergusson
860-08-21 To 860-10-23

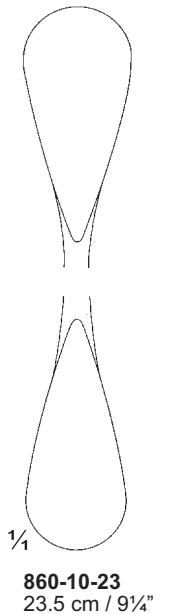
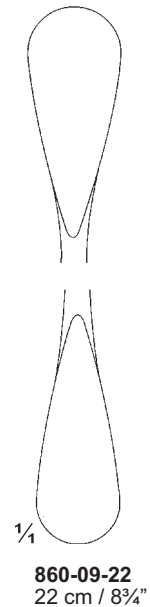
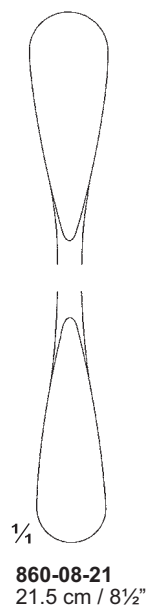



Desjardins
861-01-06 To 861-04-09
30 cm / 12"
Probe and catch
with flexible shaft



1/4
861-01-06
6 mm



1/4
861-02-07
7 mm



1/4
861-03-08
8 mm



1/4
861-04-09
9 mm



861-05-27
27 cm / 10 1/2"
Malleable

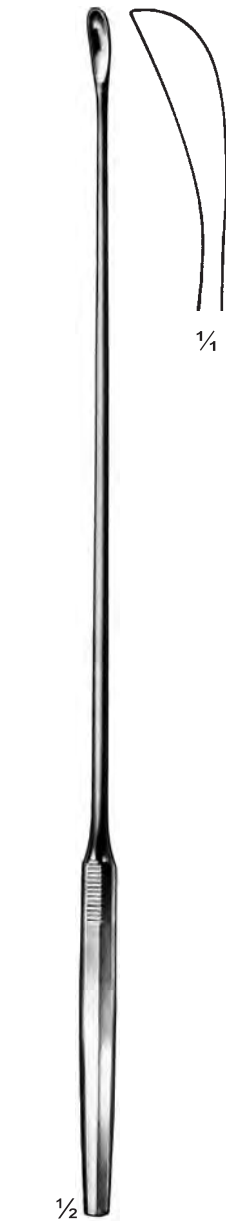

Luer-Koerte
861-06-02 To 861-13-15
32 cm / 12 3/4"
Malleable



1/4
Fig. 000
861-06-02
861-14-02
2.5 mm



1/4
Fig. 00
861-07-03
861-15-03
3.2 mm



1/4
Fig. 0
861-08-04
861-16-04
4.2 mm



1/4
Fig. 1
861-09-05
861-17-05
5.5 mm



1/4
Fig. 2
861-10-06
861-18-06
6.7 mm



1/4
Fig. 3
861-11-08
861-19-08
8.0 mm



1/4
Fig. 4
861-12-11
861-20-11
11 mm



1/4
Fig. 5
861-13-15
861-21-15
15 mm



Luer-Koerte
861-14-02 To 861-21-15
27.5 cm / 10 3/4"
Malleable



861-22-07
7 mm



861-23-08
8 mm



861-24-09
9 mm

861-22-07 To 861-24-09
30 cm / 12"
Malleable

Gallensteinlöffel Gall Stone Scoops Curettes pour calculs biliaires

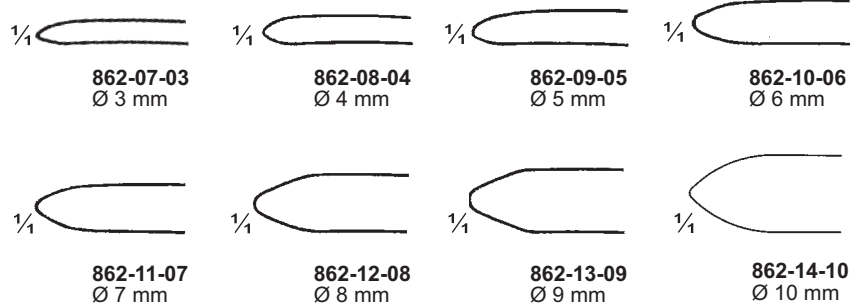

1/2
Moore
862-01-28
28 cm / 11"



1/2
862-02-34
34 cm / 12 1/2"



Mayo
862-03-04 To 862-05-07
26 cm / 10 1/4"
Malleable



1/4
862-03-04
4 mm



1/4
862-04-05
5 mm



1/4
862-05-07
7 mm



Mayo
862-06-26
26 cm / 10 1/4"
Malleable



1/4
5 mm

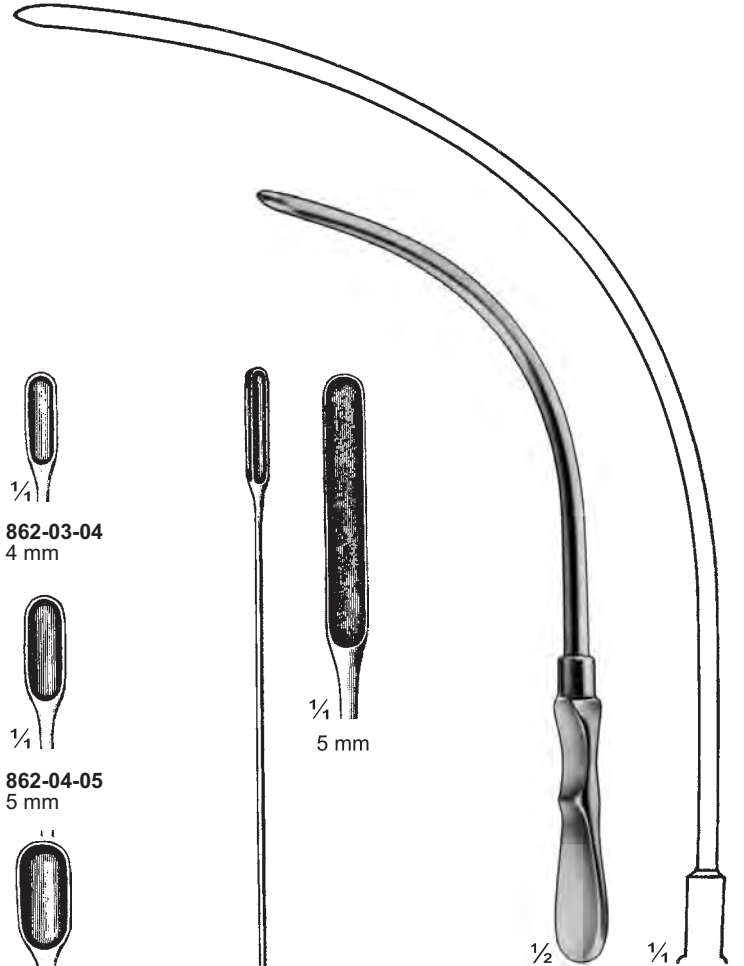

1/2
1/4
862-07-03 To 862-14-10
19 cm / 7 1/2"

Gallensteinlöffel Gall Stone Scoops Curettes pour calculs biliaires

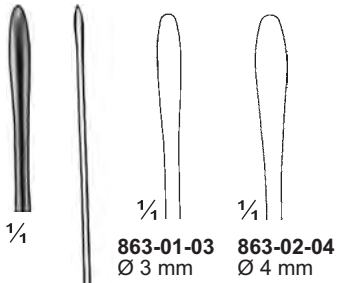

Stucker
863-01-03 To 863-02-04
33 cm / 13"
Malleable

	Charr. (French)
863-03-08	8
863-04-09	9
863-05-11	11
863-06-12	12
863-07-13	13
863-08-14	14
863-09-15	15
863-10-16	16
863-11-17	17
863-12-18	18
863-13-19	19
863-14-20	20
863-15-21	21
863-16-22	22
863-17-23	23
863-18-24	24
863-19-25	25
863-20-26	26
863-21-27	27
863-22-28	28
863-23-29	29
863-24-30	30

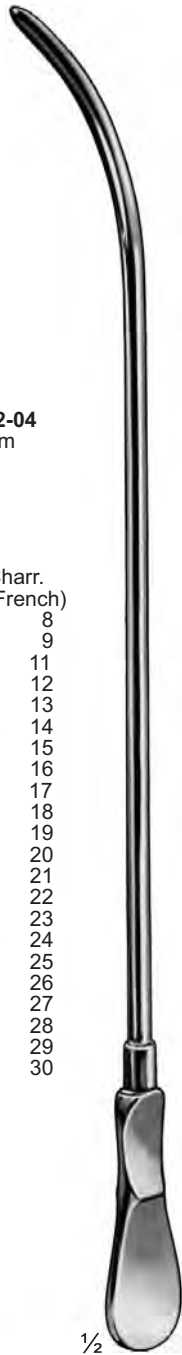

Dittel
863-03-08 To 863-24-30
34.5 cm / 13 1/4"
Dilating sound



Bakes
863-25-01 To 863-37-13
30 cm / 12"
Malleable shaft

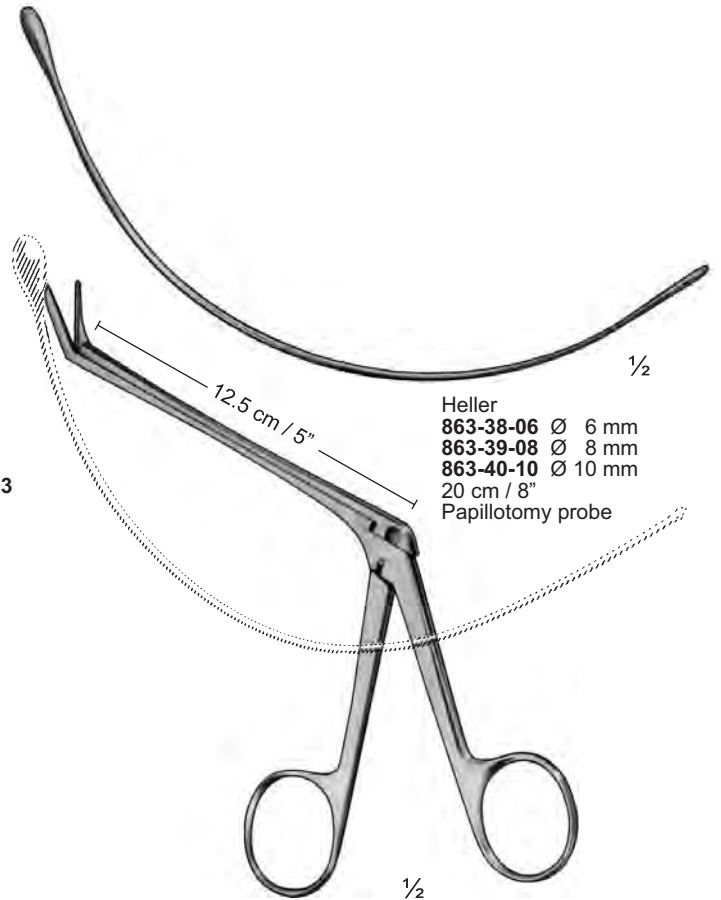
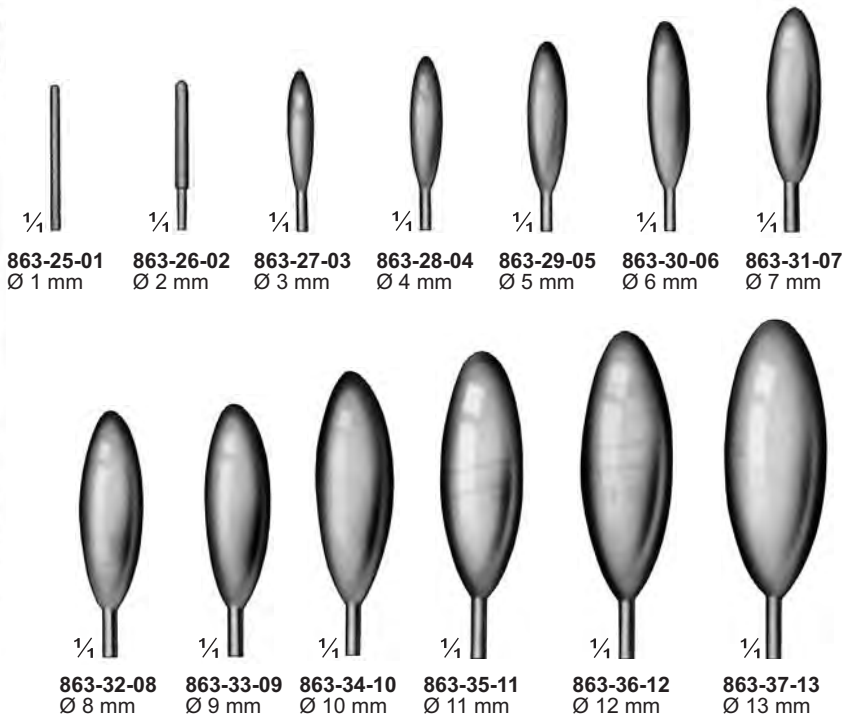

Heller
863-41-12
Shaft length 12.5 cm / 5"
Biopsy forceps for papilla

Nierensteinzangen
Kidney Stone Forceps
Pinces pour les calculs du bassinet

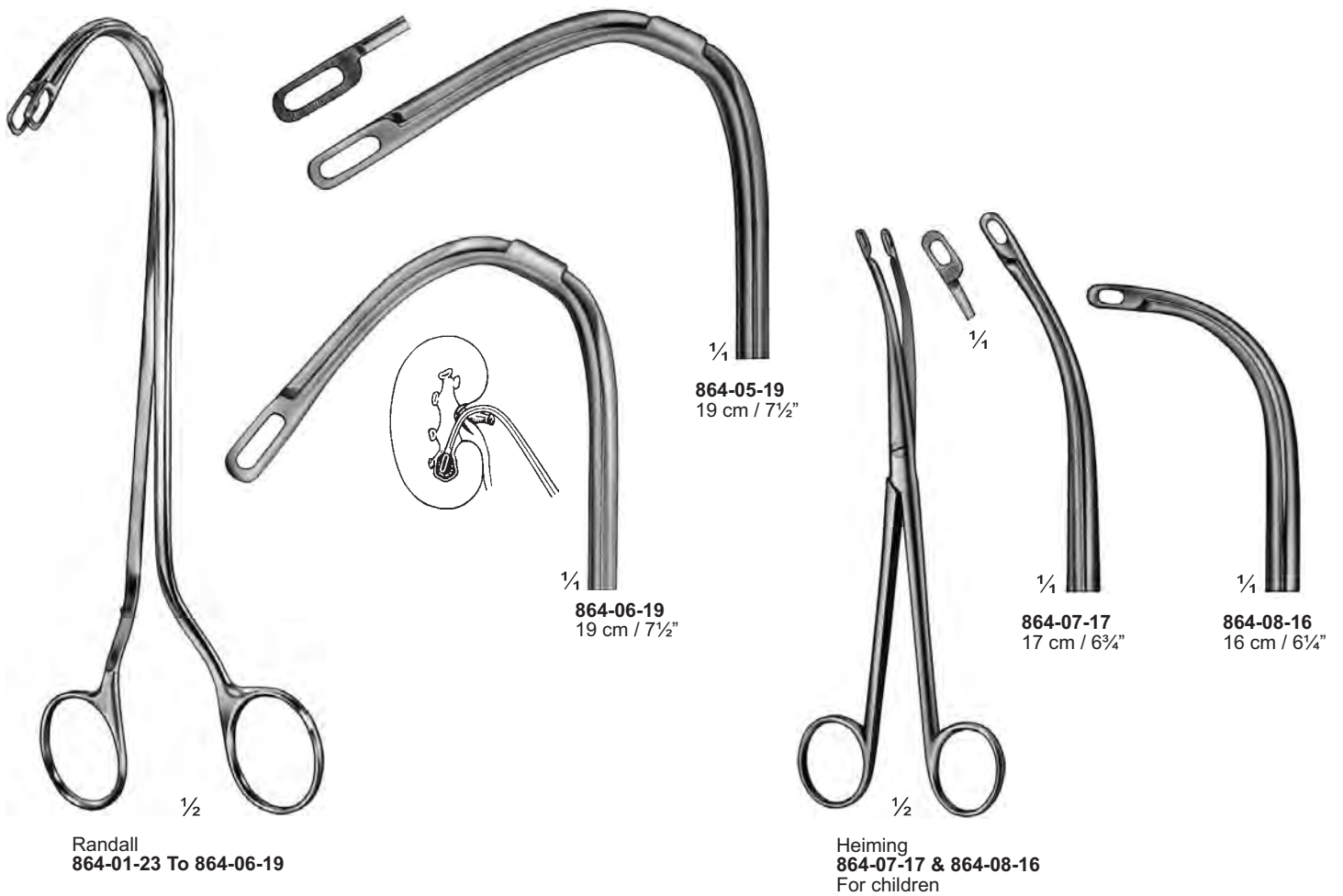
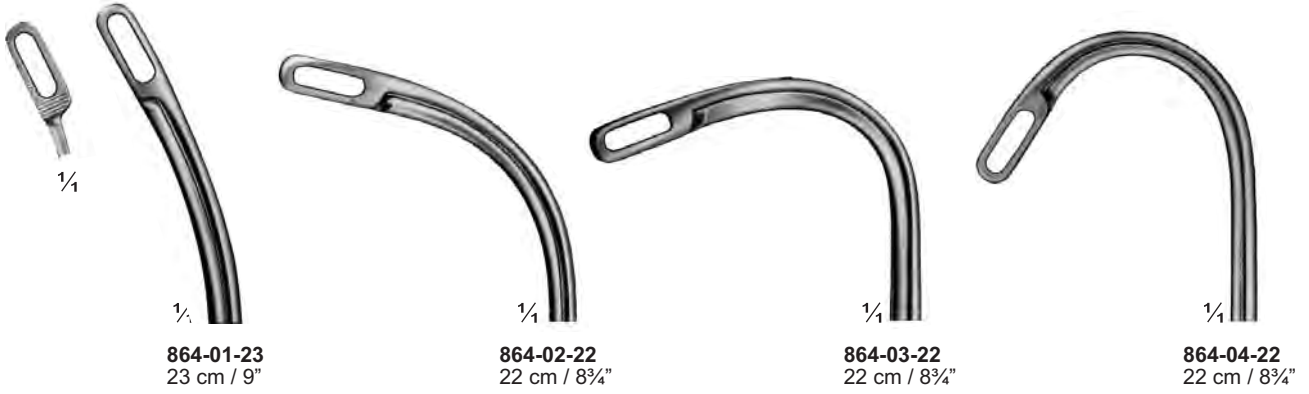
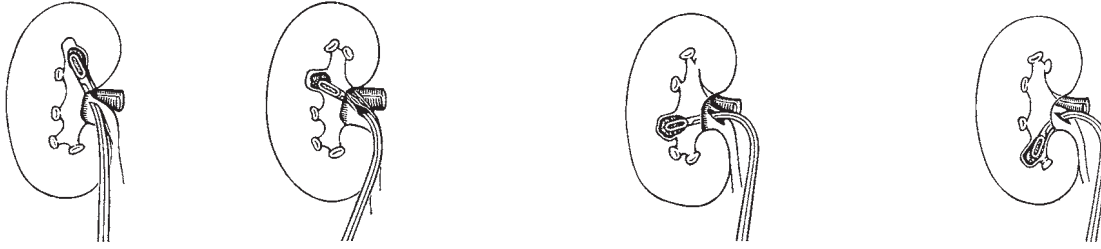

Nierensteinzangen
Kidney Stone Forceps
Pinces pour les calculs du bassinet

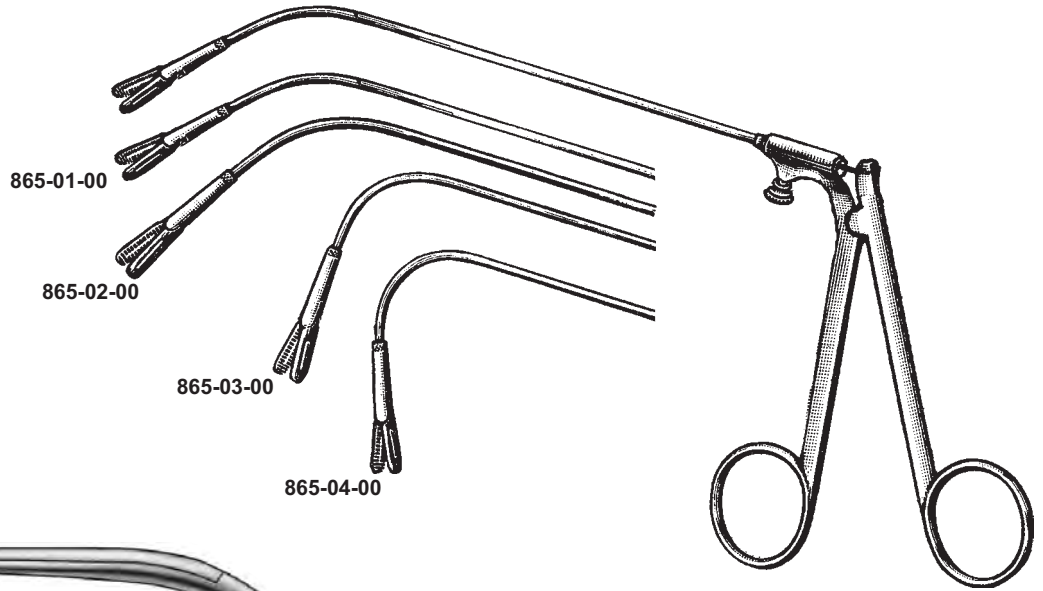

Ray
 865-01-00 To 865-04-00
 865-05-00
 Complete set of 865-01-00 To 865-04-00



865-06-23
 23 cm / 9"

1/4

1/2

Randall
 865-06-23 & 865-07-24

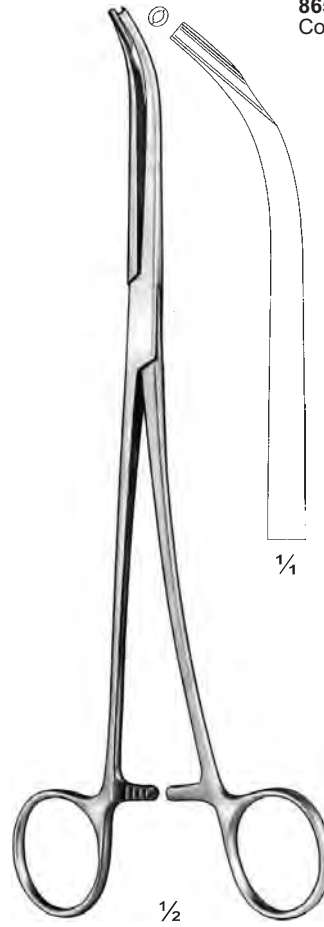

Sokeland
 865-08-24
 24 cm / 9 1/2"



Hirth
 865-09-18
 18 cm / 7"

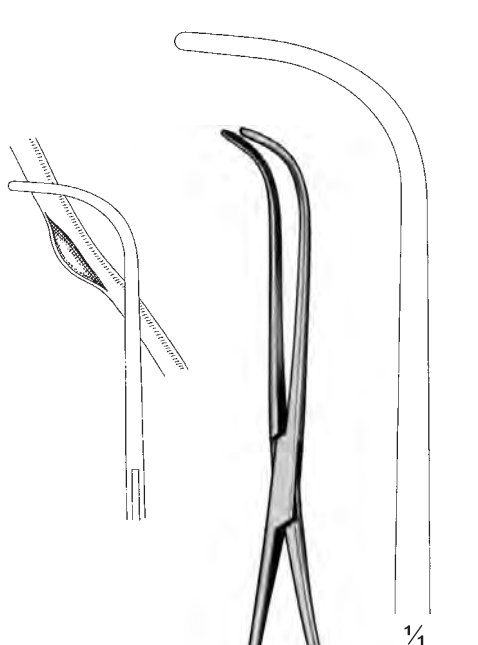

$\frac{1}{2}$
Lurz
866-01-21
21 cm / 8 $\frac{1}{4}$ "

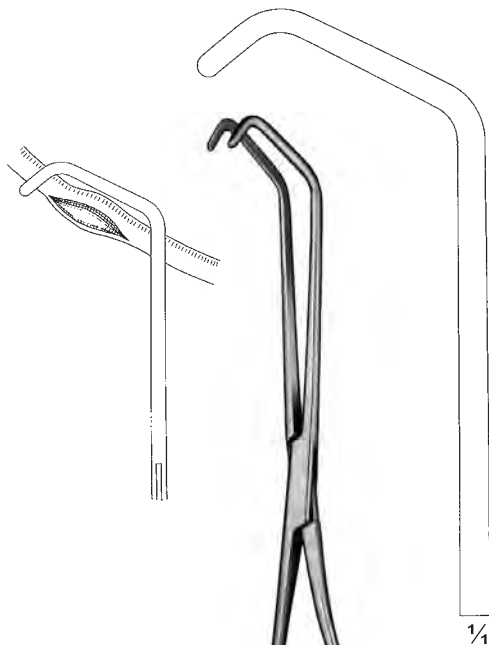

$\frac{1}{2}$
Lurz
866-02-21
21 cm / 8 $\frac{1}{4}$ "

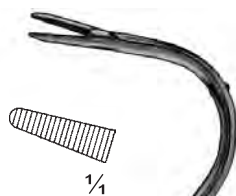

$\frac{1}{2}$
Elsasser
866-03-20
20 cm / 8"

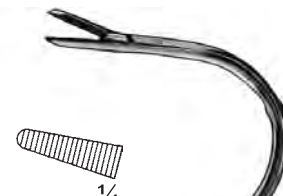

$\frac{1}{2}$
Elsasser
866-04-20
20 cm / 8"



$\frac{1}{2}$
Collin
867-01-28
28.5 cm / 11 $\frac{1}{4}$ "



$\frac{1}{2}$
Kocher
867-02-26
26.5 cm / 10 $\frac{1}{2}$ "



$\frac{1}{2}$
Dartigues
867-03-25
25 cm / 10"

Niere Pedicle Zange
Kidney Pedicle Forceps
Les Forceps De Pedicle De Rein

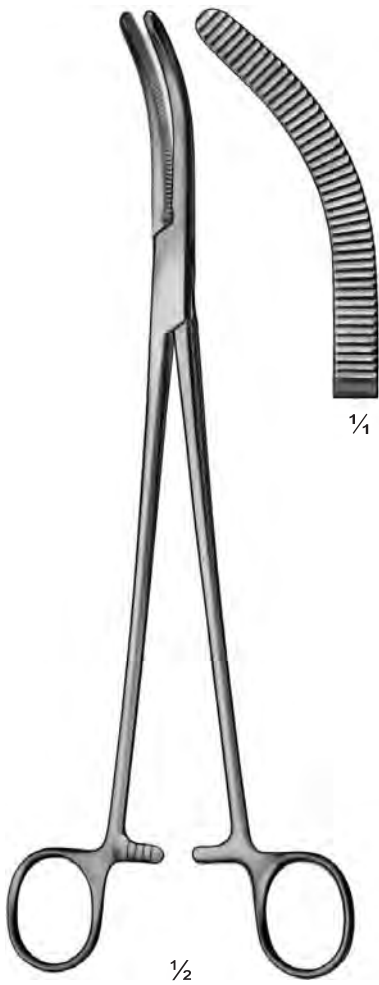

Wertheim
868-01-25
25 cm / 10"



Wertheim-Cullen
868-02-21
21.5 cm / 8½"
Angle and pressure clamp

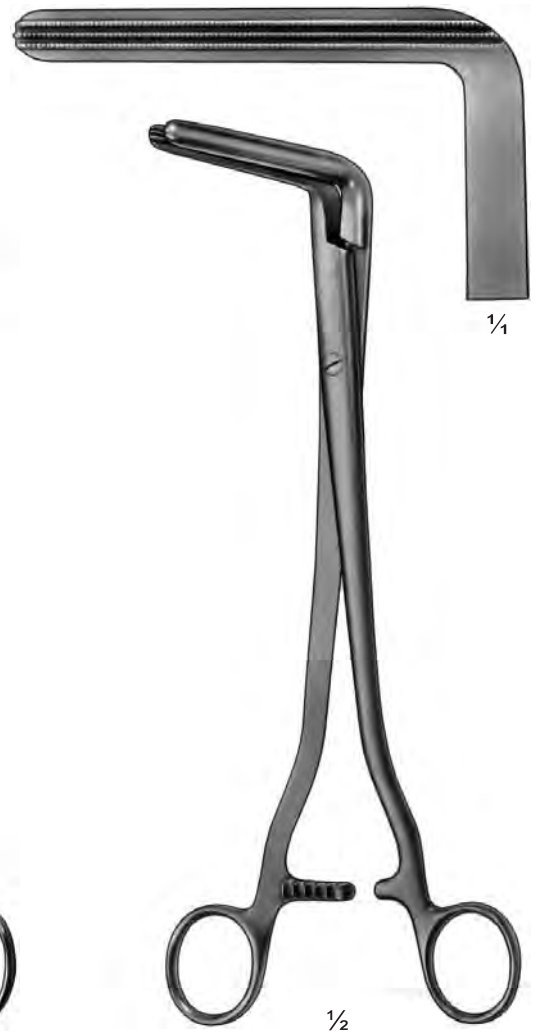

Wertheim
868-03-25
25 cm / 10"
Angle and pressure clamp
Atrauma toothed



Hrytschak
869-01-00
 Lateral balde 40 X 85 mm
 Central balde 35 X 100 mm



1/4

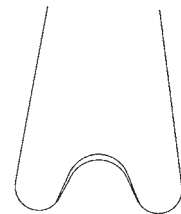

1/4



1/4



1/2

Young
869-02-21
 21 cm / 8 1/4"

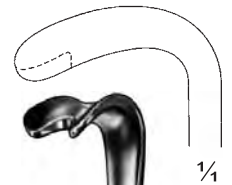

1/4



1/2

Young
869-03-21
 21 cm / 8 1/4"

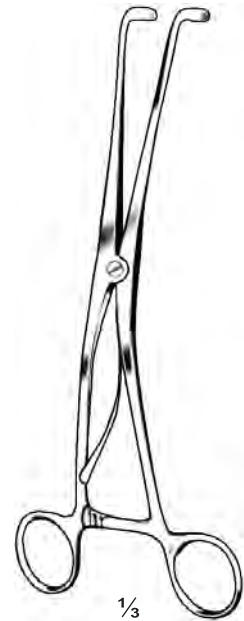
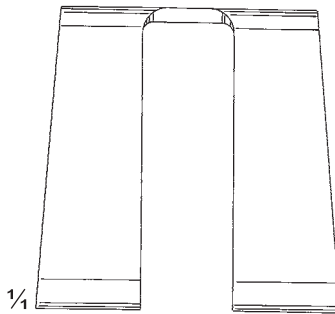
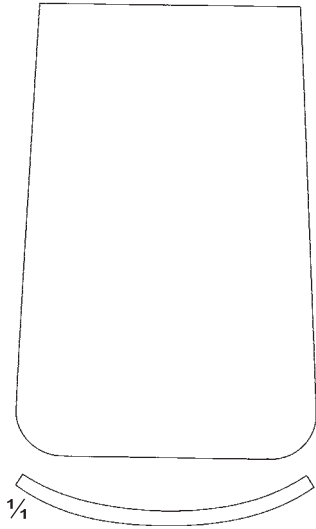

Millin-Bacon
870-04-24
 24 cm / 9 1/2"



Young
870-01-22
 22 cm / 8 3/4"



Young
870-02-22
 22 cm / 8 3/4"

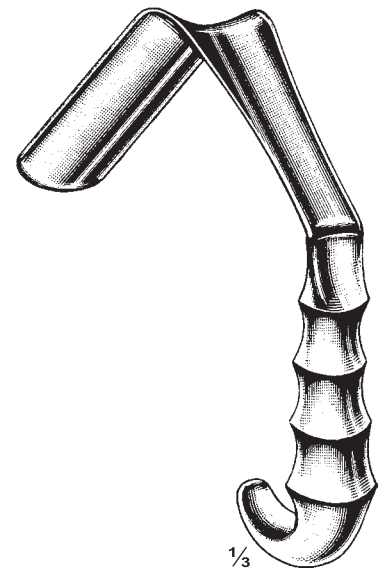

Proust
870-03-21
 21 cm / 8 1/4"
 45 X 90 mm

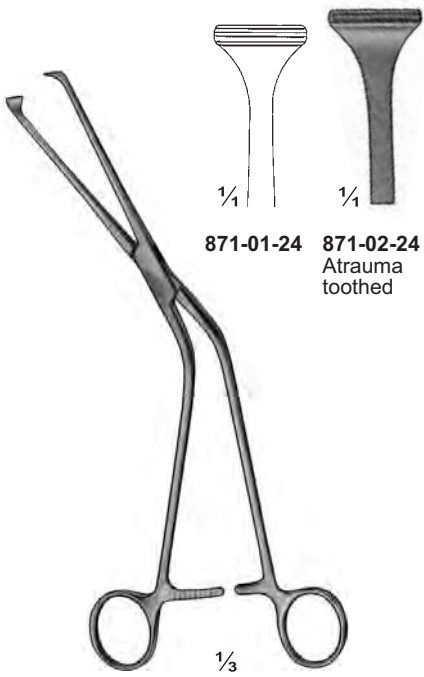

871-01-24 **871-02-24**
Atrauma
toothed

Millin
871-01-24 & 871-02-24
24.5 cm / 9 3/4"

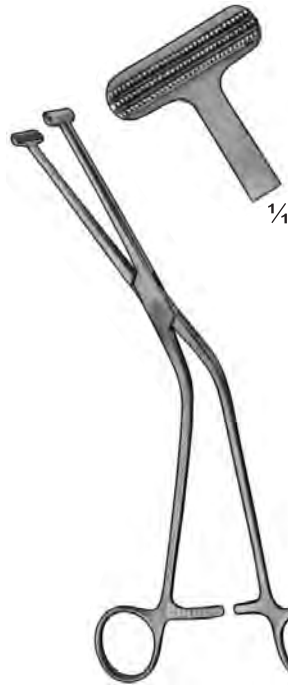

Millin
871-03-23
23.5 cm / 9 1/4"
Atrauma toothed

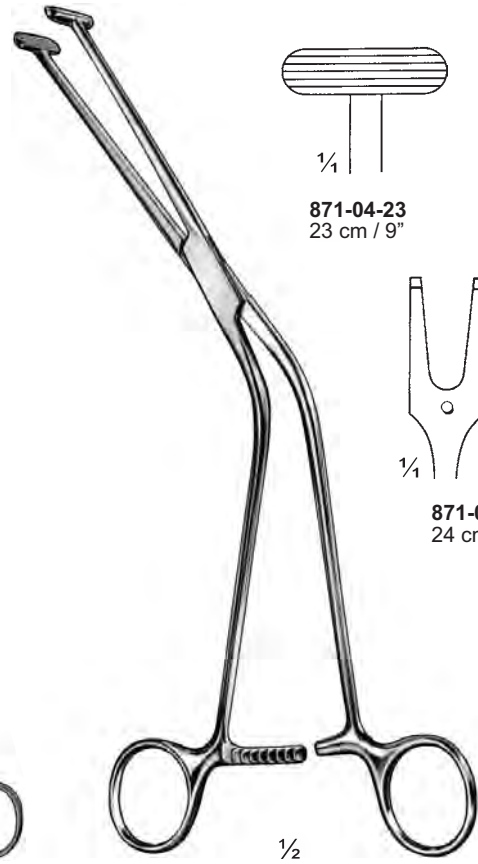

871-04-23
23 cm / 9"

871-05-23
23 cm / 9"

871-06-24
24 cm / 9 1/2"

Millin
871-04-23 To 871-06-24



Young
871-07-16
16.5 cm / 6 1/2"



871-08-12
12.5 cm / 5"
Ring diam. 4.8 mm
Forceps for grasping the
glans and the foreskin



871-09-14
14.5 cm / 5 3/4"
Fixation clamp for the
spermatic cord

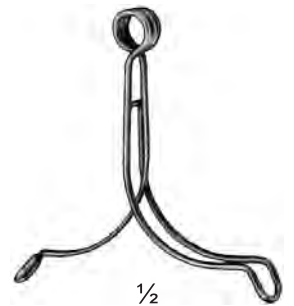

Stockmann
871-10-07
7 cm / 2 3/4"
Penis clamp



$\frac{1}{2}$
Strauss
872-01-13
13 cm / 5 $\frac{1}{8}$ "
Penis clamp



$\frac{1}{2}$
872-02-16
16 cm / 6 $\frac{1}{4}$ "
Hook for the
spermatic cord



$\frac{1}{2}$
Young
872-03-20
20 cm / 8"
Prostatic lobe forceps

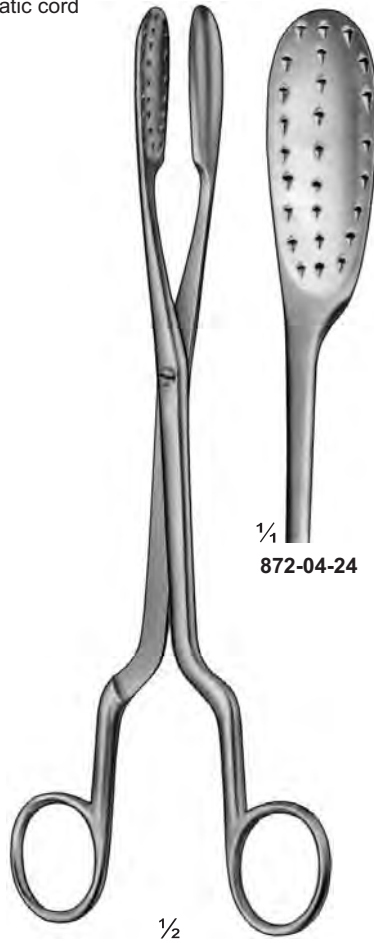

$\frac{1}{2}$
Lewkowitz
872-04-24 To 872-0-245
24.5 cm / 9 $\frac{3}{4}$ "
Lithotomy forceps



$\frac{1}{4}$
872-05-24

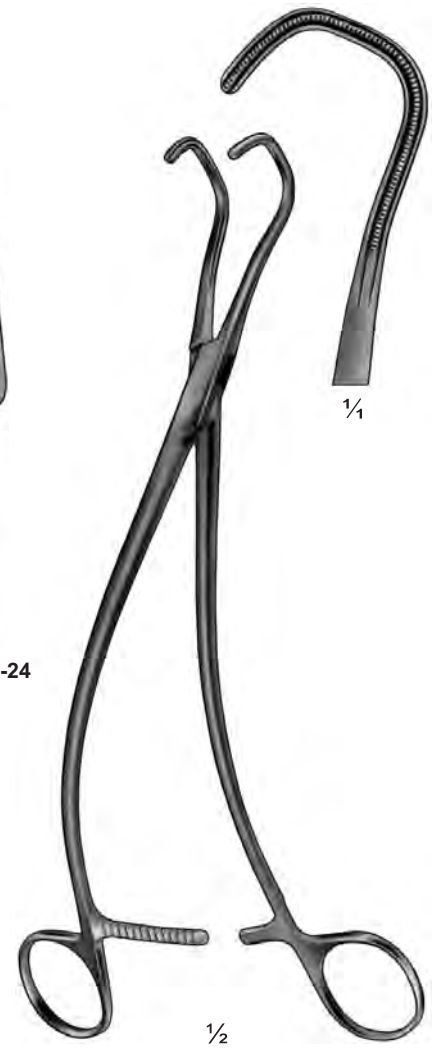

$\frac{1}{2}$
872-06-24
24 cm / 9 $\frac{1}{2}$ "
Ureter forceps
Atrauma toothed

873-01-39
39 cm / 15½"

873-02-35
35 cm / 13¾"

873-03-49
49 cm / 19½"
Catheter guide

873-04-46
46 cm / 18"
Catheter guide

873-05-08 To 873-11-20
29 cm / 11½"
Male catheter

873-12-06 To 873-24-20
16 cm / 6¼"
Female catheter

873-25-06 To 873-42-27
15 cm / 6"

Model	Charr. (French)
873-05-08	8
873-06-10	10
873-07-12	12
873-08-14	14
873-09-16	16
873-10-18	18
873-11-20	20
873-12-06	6
873-13-07	7
873-14-08	8
873-15-09	9
873-16-10	10
873-17-11	11
873-18-12	12
873-19-13	13
873-20-14	14
873-21-15	15
873-22-16	16
873-23-18	18
873-24-20	20
873-25-06	6
873-26-07	7
873-27-08	8
873-28-09	9
873-29-10	10
873-30-11	11
873-31-12	12
873-32-13	13
873-33-14	14
873-34-15	15
873-35-16	16
873-36-17	17
873-37-18	18
873-38-20	20
873-39-21	21
873-40-23	23
873-41-24	24
873-42-27	27



Pitha
874-01-22
22 cm / 8³/₄"
Foreign body forceps

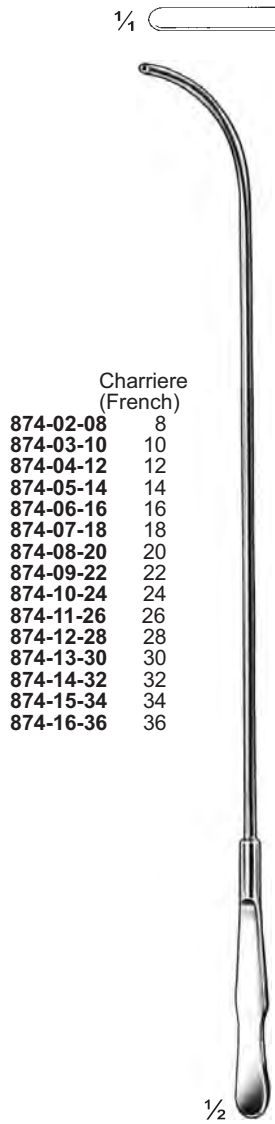

	Charriere (French)
874-02-08	8
874-03-10	10
874-04-12	12
874-05-14	14
874-06-16	16
874-07-18	18
874-08-20	20
874-09-22	22
874-10-24	24
874-11-26	26
874-12-28	28
874-13-30	30
874-14-32	32
874-15-34	34
874-16-36	36

Van Buren
874-02-08 To 874-16-36
28 cm / 11"
874-17-00
Complete set of
874-02-08 To 874-16-36

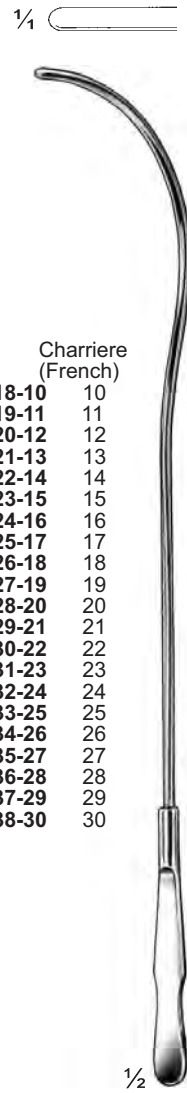

	Charriere (French)
874-18-10	10
874-19-11	11
874-20-12	12
874-21-13	13
874-22-14	14
874-23-15	15
874-24-16	16
874-25-17	17
874-26-18	18
874-27-19	19
874-28-20	20
874-29-21	21
874-30-22	22
874-31-23	23
874-32-24	24
874-33-25	25
874-34-26	26
874-35-27	27
874-36-28	28
874-37-29	29
874-38-30	30

Guyon
874-18-10 To 874-38-30
26 cm / 10¹/₄"
874-39-00
Complete set of
874-18-10 To 874-38-30

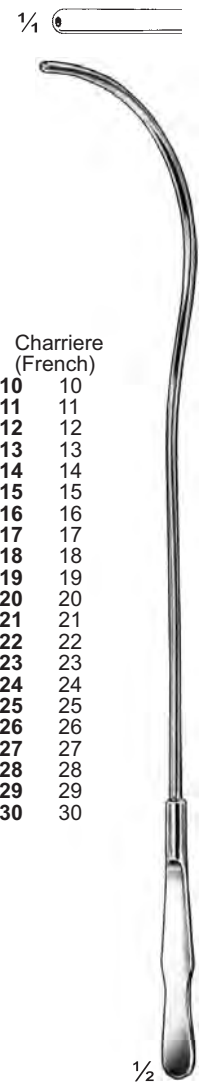

	Charriere (French)
874-40-10	10
874-41-11	11
874-42-12	12
874-43-13	13
874-44-14	14
874-45-15	15
874-46-16	16
874-47-17	17
874-48-18	18
874-49-19	19
874-50-20	20
874-51-21	21
874-52-22	22
874-53-23	23
874-54-24	24
874-55-25	25
874-56-26	26
874-57-27	27
874-58-28	28
874-59-29	29
874-60-30	30

Guyon
874-40-10 To 874-60-30
26 cm / 10¹/₄"
874-61-00
Complete set of
874-40-10 To 874-60-30

Charriere (French)	
875-01-06	6
875-02-07	7
875-03-08	8
875-04-09	9
875-05-10	10
875-06-11	11
875-07-12	12
875-08-13	13
875-09-14	14
875-10-15	15
875-11-16	16
875-12-17	17
875-13-18	18
875-14-19	19
875-15-20	20
875-16-21	21
875-17-22	22
875-18-23	23
875-19-24	24
875-20-25	25
875-21-26	26
875-22-27	27
875-23-28	28
875-24-29	29
875-25-30	30
875-26-31	31
875-27-32	32
875-28-33	33
875-29-34	34
875-30-35	35
875-31-36	36



1/2

Dittel
875-01-06 To 875-31-36
22 cm / 8 3/4"
875-32-00
Complete set of
875-01-06 To 875-31-36

Charriere (French)	
875-33-06	6
875-34-07	7
875-35-08	8
875-36-09	9
875-37-10	10
875-38-11	11
875-39-12	12
875-40-13	13
875-41-14	14
875-42-15	15
875-43-16	16
875-44-17	17
875-45-18	18
875-46-19	19
875-47-20	20
875-48-21	21
875-49-22	22
875-50-23	23
875-51-24	24
875-52-25	25
875-53-26	26
875-54-27	27
875-55-28	28
875-56-29	29
875-57-30	30
875-58-31	31
875-59-32	32
875-60-33	33
875-61-34	34
875-62-35	35
875-63-36	36

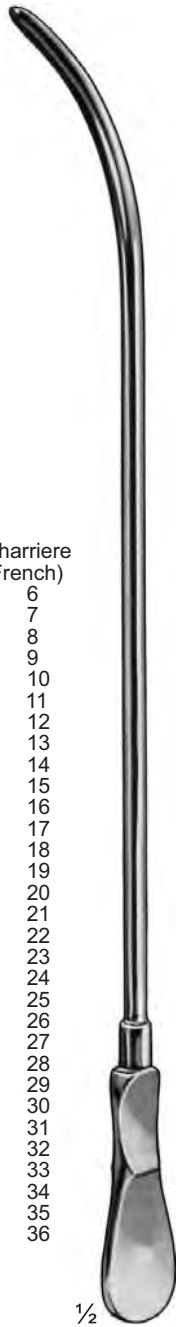

1/2

Dittel
875-33-06 To 875-63-36
34.5 cm / 13 3/4"
875-64-00
Complete set of
875-33-06 To 875-63-36

Charriere (French)	
875-65-06	6
875-66-07	7
875-67-08	8
875-68-09	9
875-69-10	10
875-70-11	11
875-71-12	12
875-72-13	13
875-73-14	14
875-74-15	15
875-75-16	16
875-76-17	17
875-77-18	18
875-78-19	19
875-79-20	20



Dittel
875-65-06 To 875-79-20
35 cm / 14"
875-80-00
Complete set of
875-65-06 To 875-79-20

Charriere (French)	
875-81-06	6
875-82-07	7
875-83-08	8
875-84-09	9
875-85-10	10
875-86-11	11
875-87-12	12
875-88-13	13
875-89-14	14
875-90-15	15
875-91-16	16
875-92-17	17
875-93-18	18
875-94-19	19
875-95-20	20
875-96-21	21
875-97-22	22
875-98-23	23
875-99-24	24

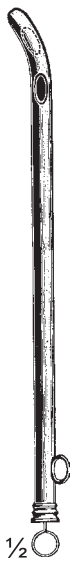

1/2

Dittel
875-81-06 To 875-99-24
15 cm / 6"
875-100-00
Complete set of
875-81-06 To 875-99-24

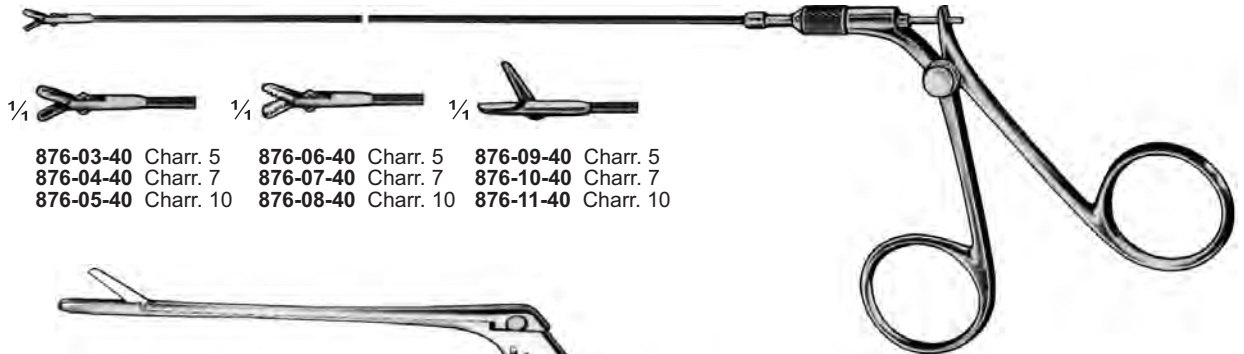

- | | | | | | |
|-----|---------------------|-----|---------------------|-----|---------------------|
| 1/4 | 876-03-40 Charr. 5 | 1/4 | 876-06-40 Charr. 5 | 1/4 | 876-09-40 Charr. 5 |
| | 876-04-40 Charr. 7 | | 876-07-40 Charr. 7 | | 876-10-40 Charr. 7 |
| | 876-05-40 Charr. 10 | | 876-08-40 Charr. 10 | | 876-11-40 Charr. 10 |

876-03-40 To 876-11-40
Shaft length 40 cm / 16"

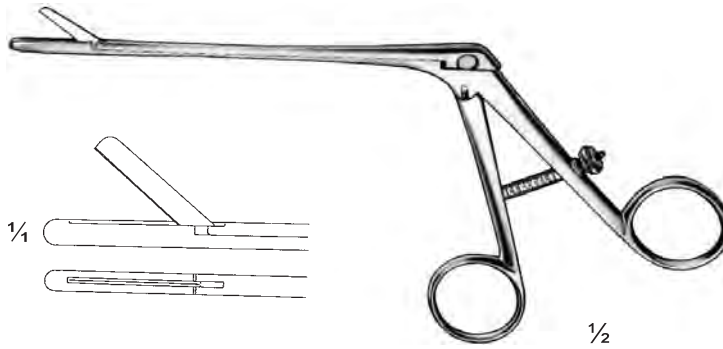

Sachse
876-12-10
Shaft length 10 cm / 4"



876-01-27
27 cm / 10 1/2"
Secretion curette

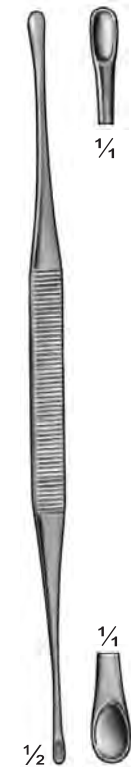

Asch
876-02-20
20 cm / 8"
Secretion curette



Sachse
876-13-20 Shaft length 20 cm / 8"
876-14-28 Shaft length 28 cm / 11"

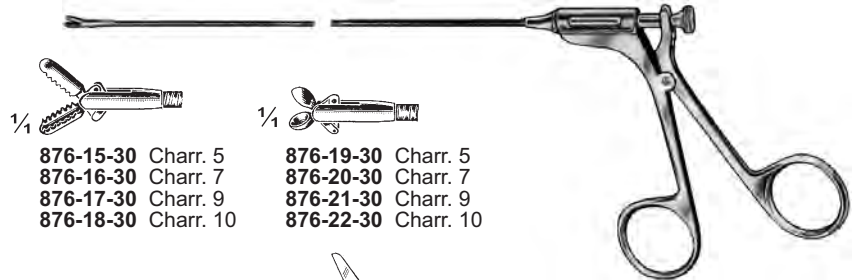

- | | | | |
|-----|---------------------|-----|---------------------|
| 1/4 | 876-15-30 Charr. 5 | 1/4 | 876-19-30 Charr. 5 |
| | 876-16-30 Charr. 7 | | 876-20-30 Charr. 7 |
| | 876-17-30 Charr. 9 | | 876-21-30 Charr. 9 |
| | 876-18-30 Charr. 10 | | 876-22-30 Charr. 10 |

876-15-30 To 876-28-30
Shaft length 30 cm / 12"

- | | | | |
|-----|--------------------|-----|---------------------|
| 1/4 | 876-23-30 Charr. 5 | 1/4 | 876-25-30 Charr. 5 |
| | 876-24-30 Charr. 7 | | 876-26-30 Charr. 7 |
| | | | 876-27-30 Charr. 9 |
| | | | 876-28-30 Charr. 10 |



1/3

Guyon
877-01-21
Set of 21 urethral bougies and dilating sounds
packed in metal case



1/2

877-05-00
Knutson urethrography
instrument



Winkelmann
877-02-12 Ø 12 mm
877-03-16 Ø 16 mm
877-04-20 Ø 20 mm
Circumcision clamps



1/2

877-06-08 Ø 8 mm
877-07-11 Ø 11 mm
877-08-13 Ø 13 mm
877-09-16 Ø 16 mm
877-10-21 Ø 21 mm
877-11-26 Ø 26 mm
877-12-32 Ø 32 mm
Circumcision instruments

Hakenzangen
Uterine Tenaculum Forceps
Pince pour le col delutérus

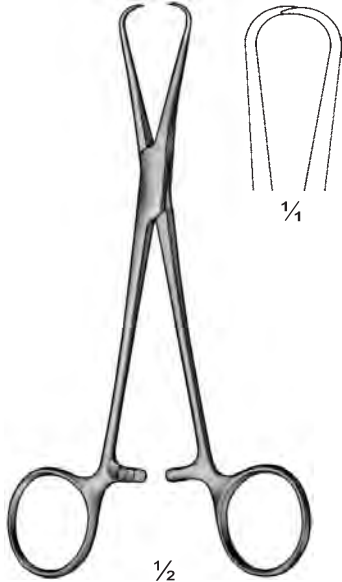

$\frac{1}{2}$
Bernhard
878-01-16
 16 cm / 6 $\frac{1}{4}$ "

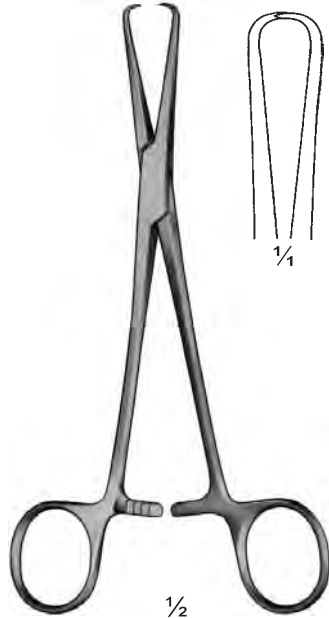

$\frac{1}{2}$
Pozzi
878-02-18
 18 cm / 7"

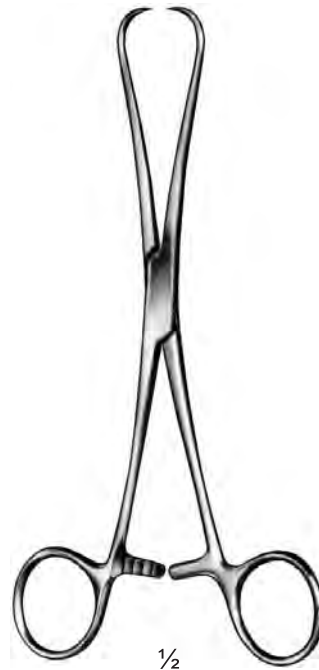

$\frac{1}{2}$
Stade-Moore
878-03-17
 17 cm / 6 $\frac{3}{4}$ "
 Strong pattern



$\frac{1}{2}$
Barrett
878-04-18
 18 cm / 7"

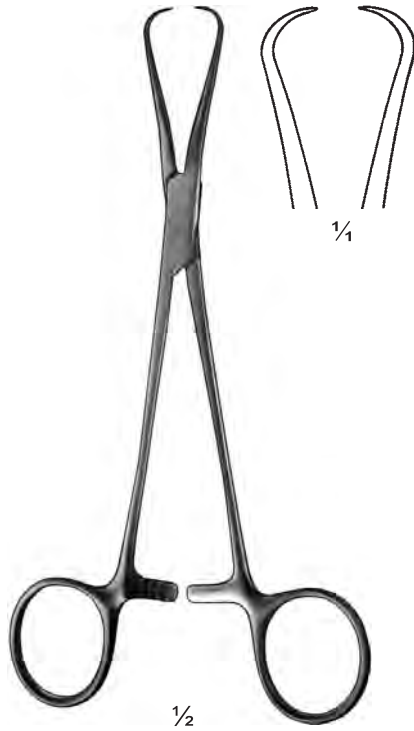

$\frac{1}{2}$
Adair
878-05-19
 19 cm / 7 $\frac{1}{2}$ "



Braun
878-06-25
 25 cm / 10"

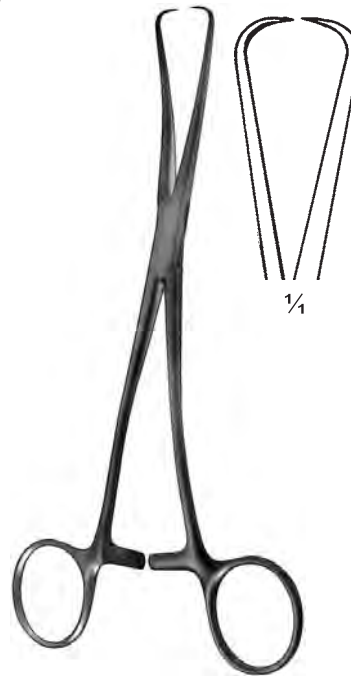

Jarcho
878-07-20
 20 cm / 8"

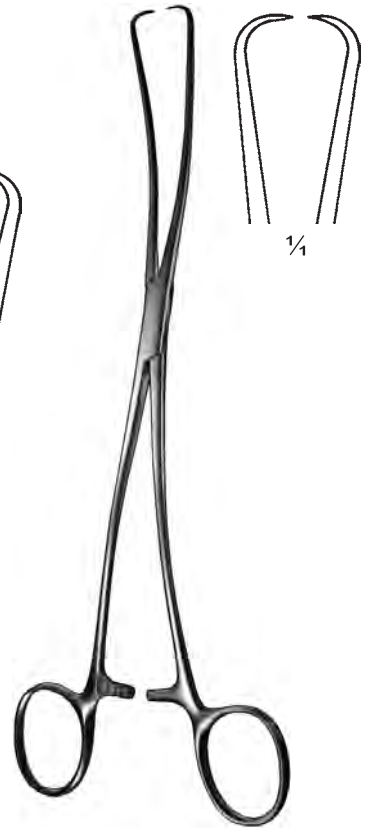

Duplay
878-08-25 25 cm / 10"
878-09-28 28 cm / 11"