

Hakenzangen
Uterine Tenaculum Forceps
Pince pour le col delutérus

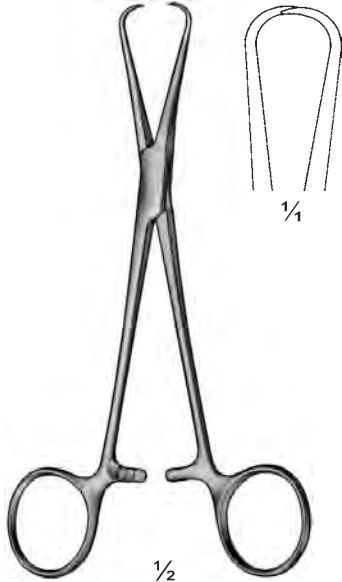

$\frac{1}{2}$
Bernhard
878-01-16
 16 cm / 6 $\frac{1}{4}$ "

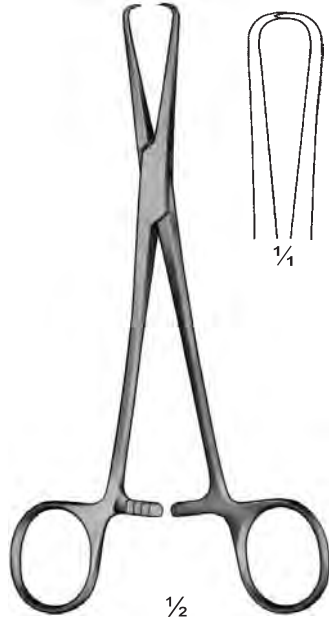

$\frac{1}{2}$
Pozzi
878-02-18
 18 cm / 7"

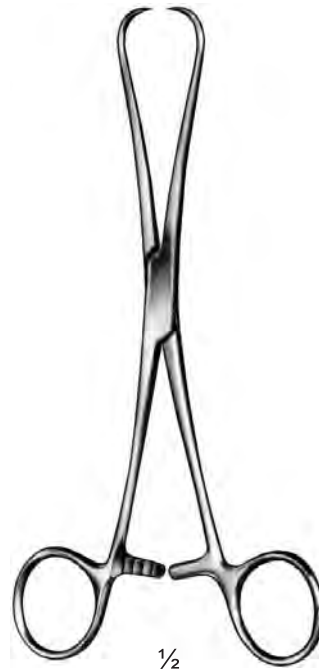

$\frac{1}{2}$
Stade-Moore
878-03-17
 17 cm / 6 $\frac{3}{4}$ "
 Strong pattern



$\frac{1}{2}$
Barrett
878-04-18
 18 cm / 7"



$\frac{1}{2}$
Adair
878-05-19
 19 cm / 7 $\frac{1}{2}$ "



$\frac{1}{4}$
Braun
878-06-25
 25 cm / 10"



$\frac{1}{4}$
Jarcho
878-07-20
 20 cm / 8"

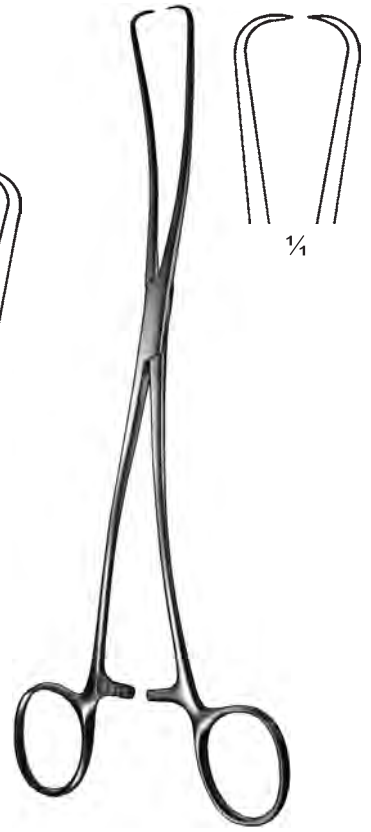

$\frac{1}{4}$
Duplay
878-08-25 25 cm / 10"
878-09-28 28 cm / 11"

Hakenzangen
Uterine Tenaculum Forceps
Pince pour le col delutérus

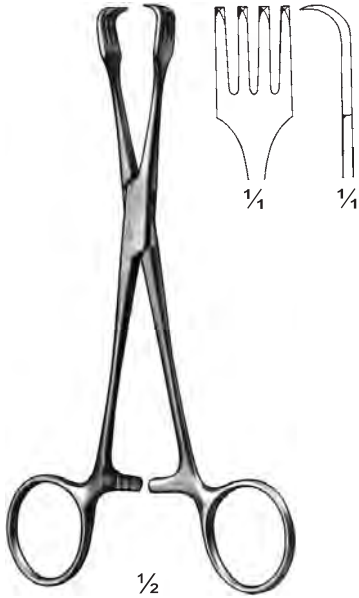

Braun
879-01-16
 16 cm / 6¼"

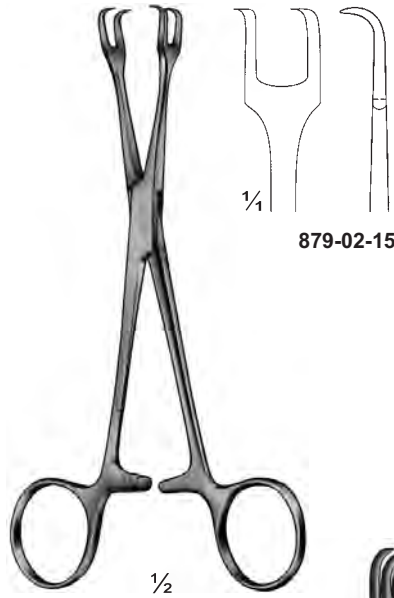

Lahey
879-02-15 & 879-03-15
 15 cm / 6"

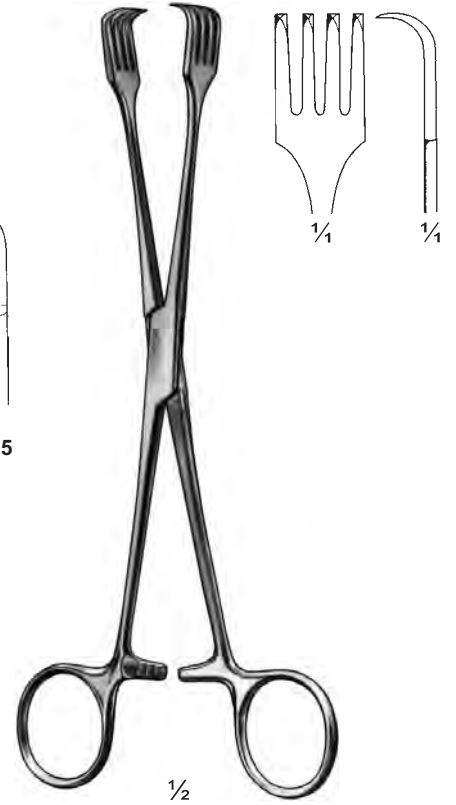
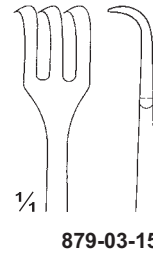

Czery
879-04-21
 21 cm / 8¼"

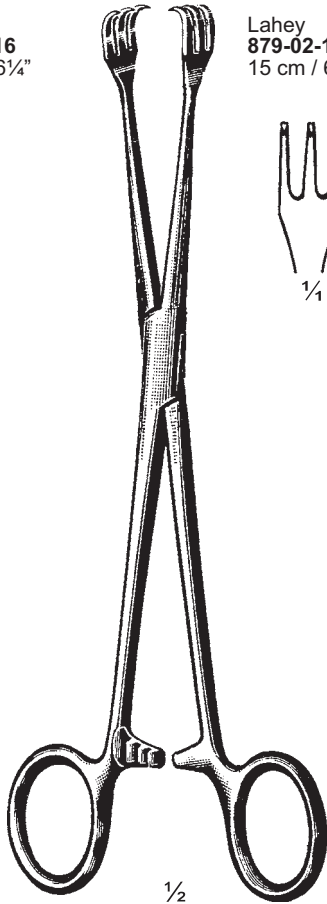

Gordon
879-05-24
 24 cm / 9½"



879-06-24
 24 cm / 9½"

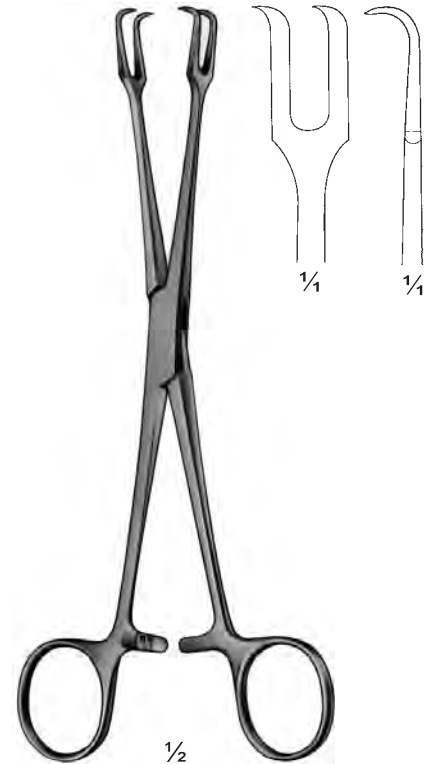

Museux
879-07-20
 20 cm / 8"

Hakenzangen
Uterine Tenaculum Forceps
Pince pour le col delutérus



Schroeder
880-01-25 To 880-03-25
 25 cm / 10"

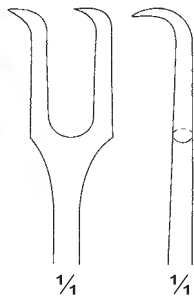

1/4



1/4



1/2

880-01-25



1/2

880-02-25



1/2

880-03-25
 Sideways cur

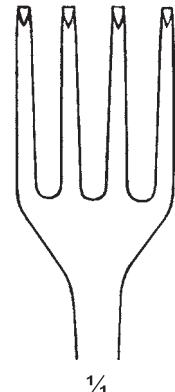

1/4

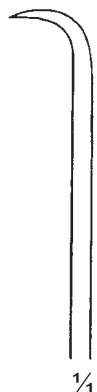

1/4

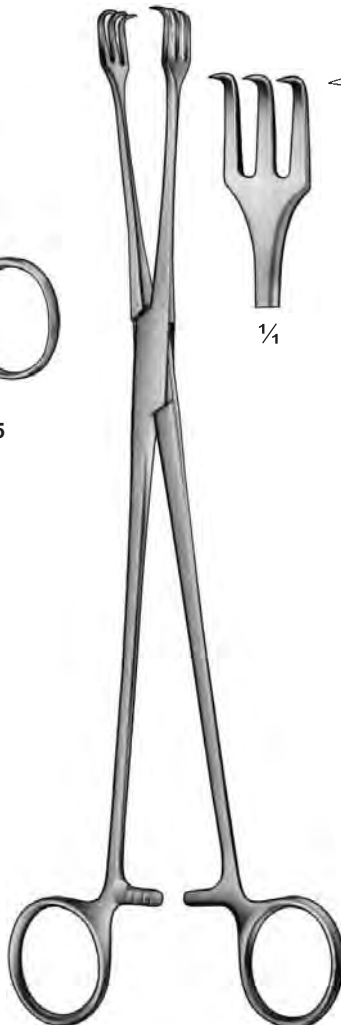

1/2

Schroeder
880-04-27
 27 cm / 10 1/2"

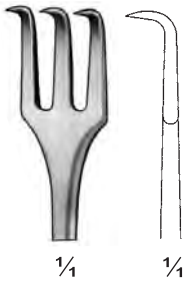

1/4



1/4

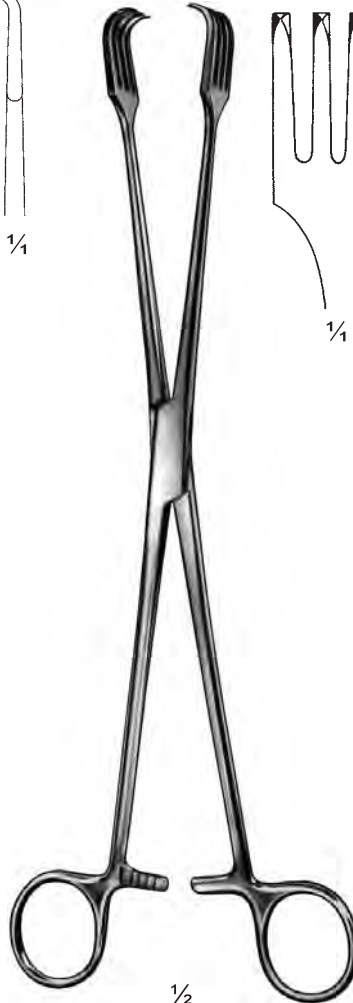

1/2

Pratt
880-05-26
 26 cm / 10 1/4"

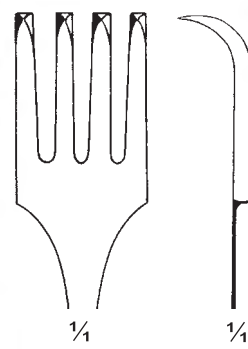

1/4



1/4



Pratt
880-06-27
 27 cm / 10 1/2"

Hakenzangen
Uterine Tenaculum Forceps
Pince pour le col delutérus

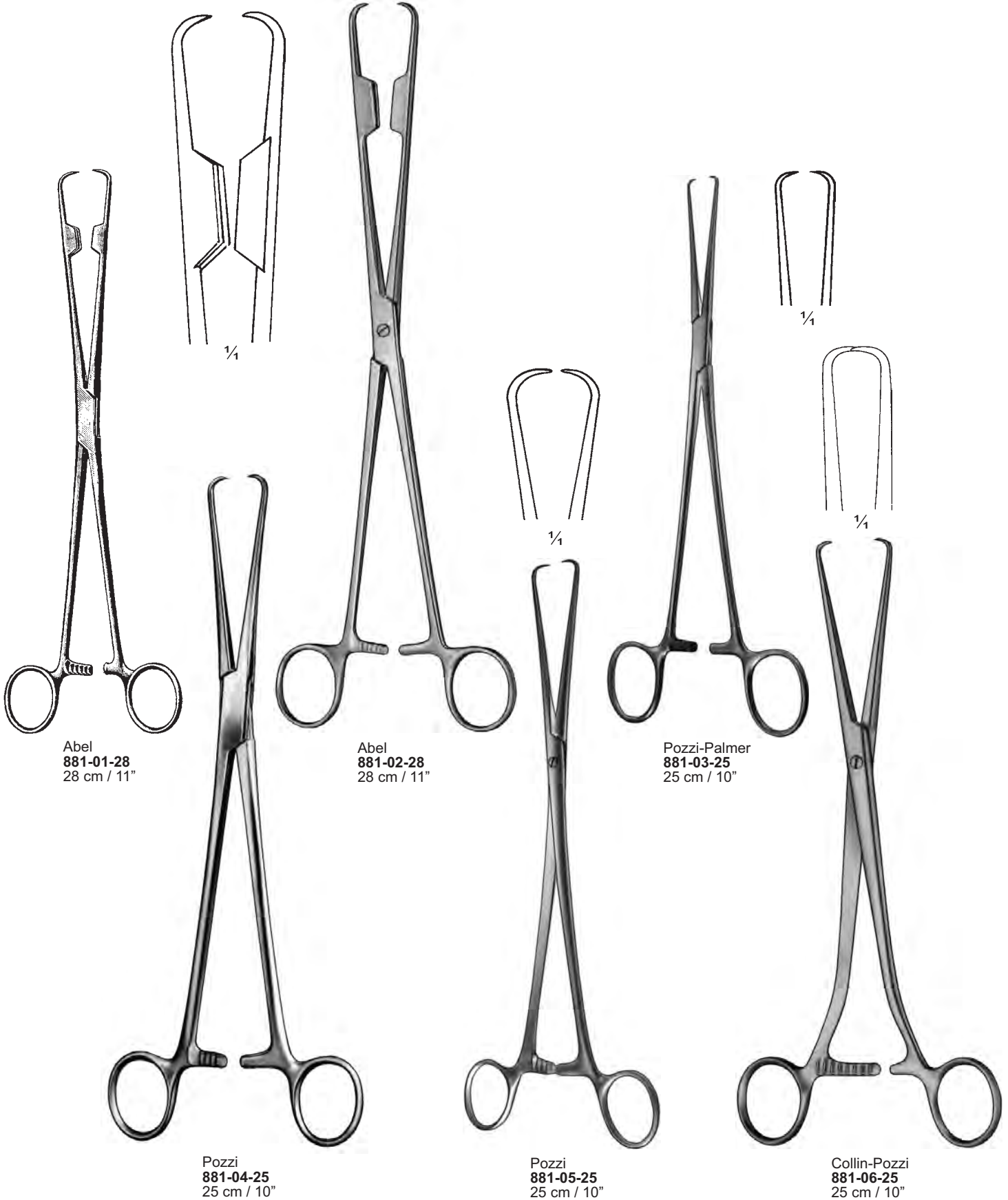

Abel
881-01-28
 28 cm / 11"

Abel
881-02-28
 28 cm / 11"

Pozzi-Palmer
881-03-25
 25 cm / 10"

Pozzi
881-04-25
 25 cm / 10"

Pozzi
881-05-25
 25 cm / 10"

Collin-Pozzi
881-06-25
 25 cm / 10"

Hakenzangen
Uterine Tenaculum Forceps
Pince pour le col delutérus

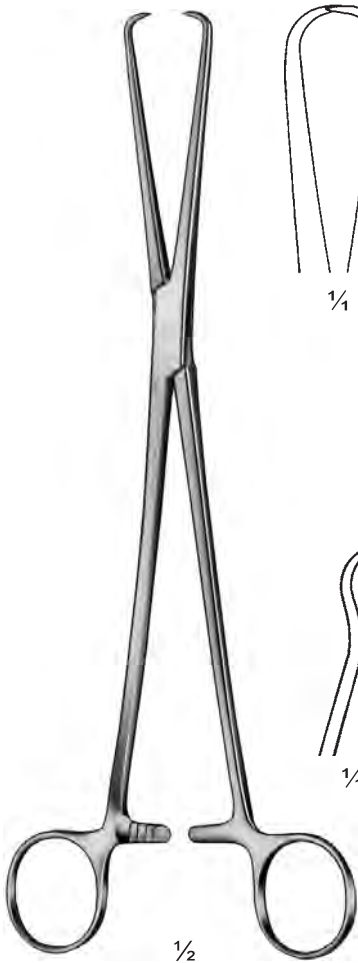

$\frac{1}{2}$
 Schroeder
882-01-25
 25 cm / 10"
 Standard

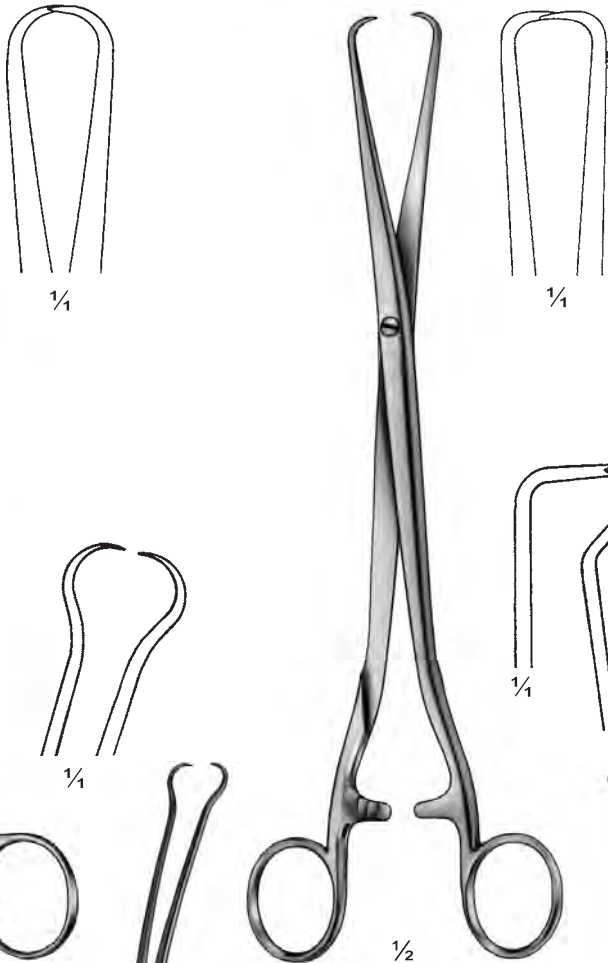

$\frac{1}{2}$
 Schroeder
882-02-25
 25 cm / 10"

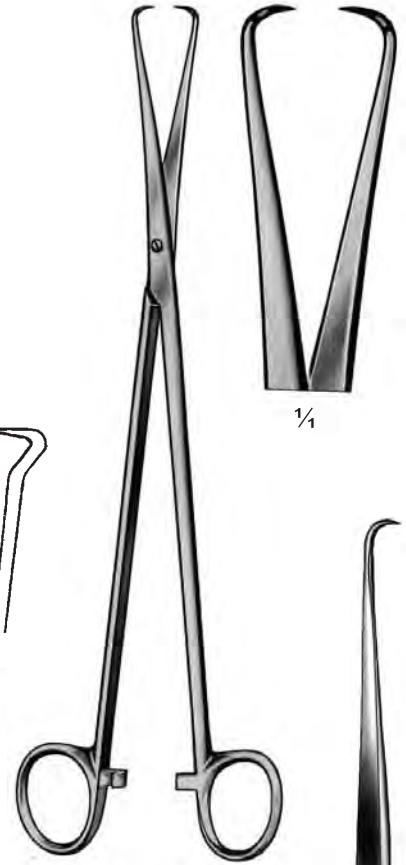

882-03-27
 27 cm / 10½"



Skene
882-04-24
 24 cm / 9½"



Kahn
882-05-24
 24 cm / 9½"



Beacham
882-06-26
 26 cm / 10¼"

Hakenzangen Uterine Tenaculum Forceps Pince pour le col delutérus

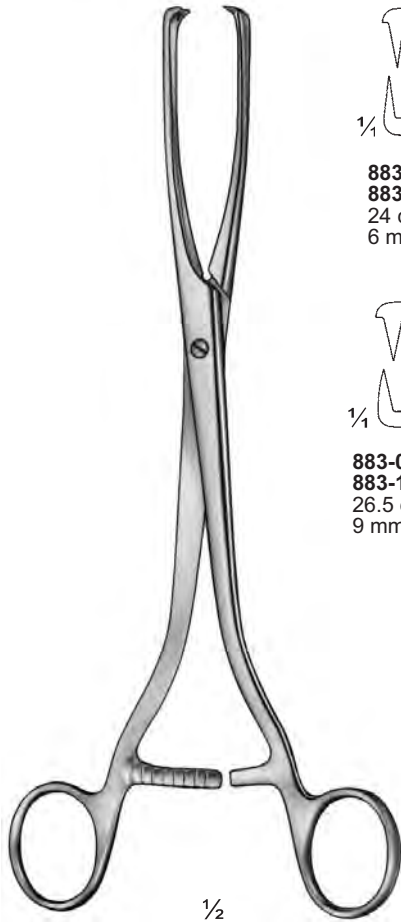

1/2

Museux
883-01-24 To 883-06-26



1/4

883-01-24
883-07-24
24 cm / 9½"
6 mm



1/4

883-02-24
883-08-24
24 cm / 9½"
8 mm



1/4

883-03-24
883-09-24
24 cm / 9½"
10 mm



1/4

883-04-26
883-10-26
26.5 cm / 10½"
9 mm

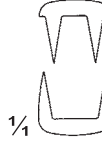

1/4

883-05-26
883-11-26
26.5 cm / 10½"
11 mm

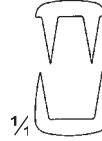

1/4

883-06-26
883-12-26
26.5 cm / 10½"
13 mm

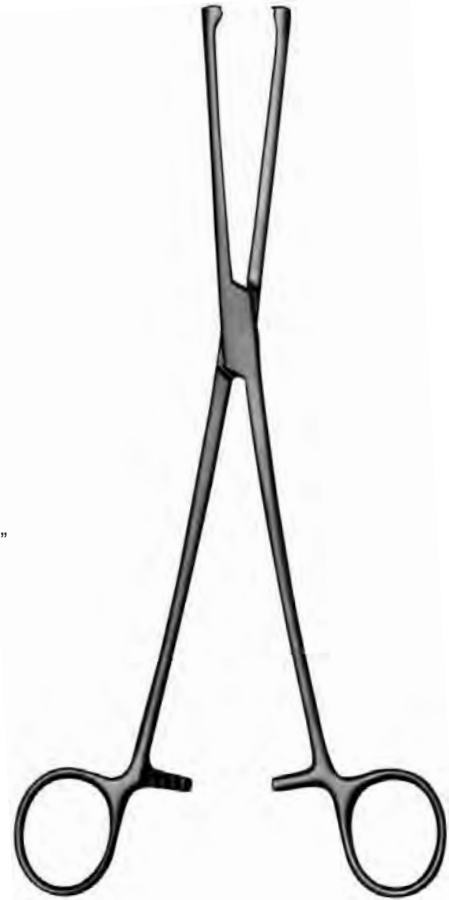

Museux
883-07-24 To 883-12-26

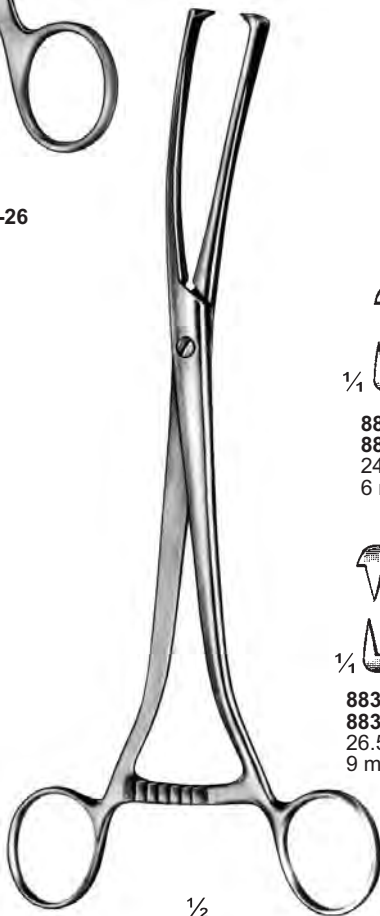

1/2

Museux
883-13-24 To 883-18-26



1/4

883-13-24
883-19-24
24 cm / 9½"
6 mm



1/4

883-14-24
883-20-24
24 cm / 9½"
8 mm



1/4

883-15-24
883-21-24
24 cm / 9½"
10 mm



1/4

883-16-26
883-22-26
26.5 cm / 10½"
9 mm



1/4

883-17-26
883-23-26
26.5 cm / 10½"
11 mm



1/4

883-18-26
883-24-26
26.5 cm / 10½"
13 mm

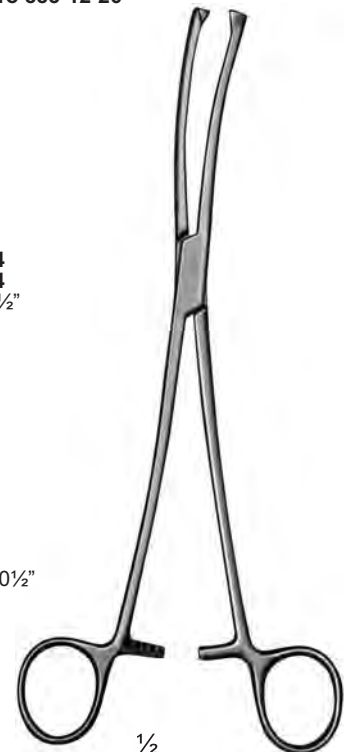

1/2

Museux
883-19-24 To 883-24-26

Hakenzangen
Uterine Tenaculum Forceps
Pince pour le col delutérus

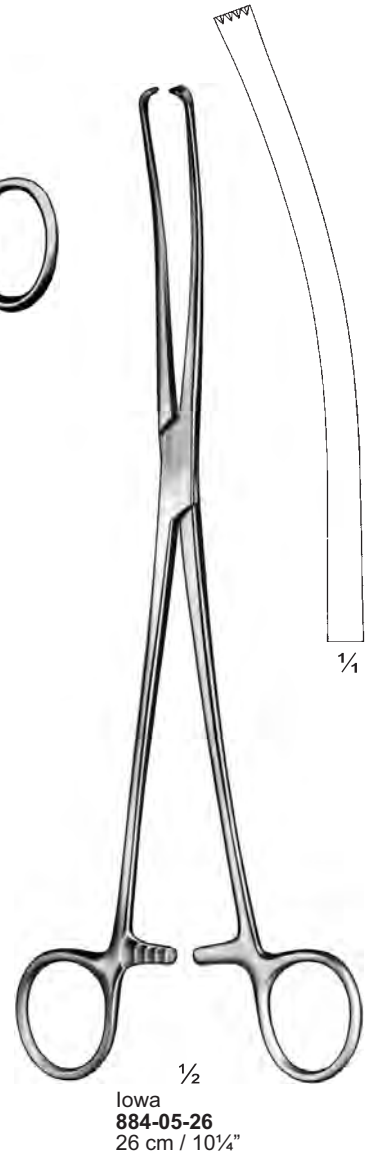
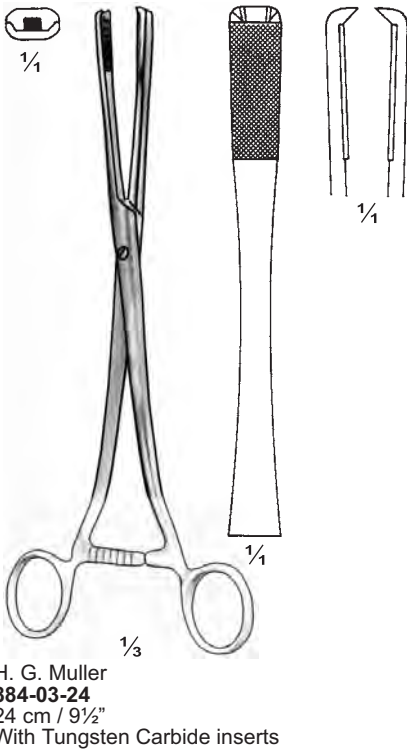
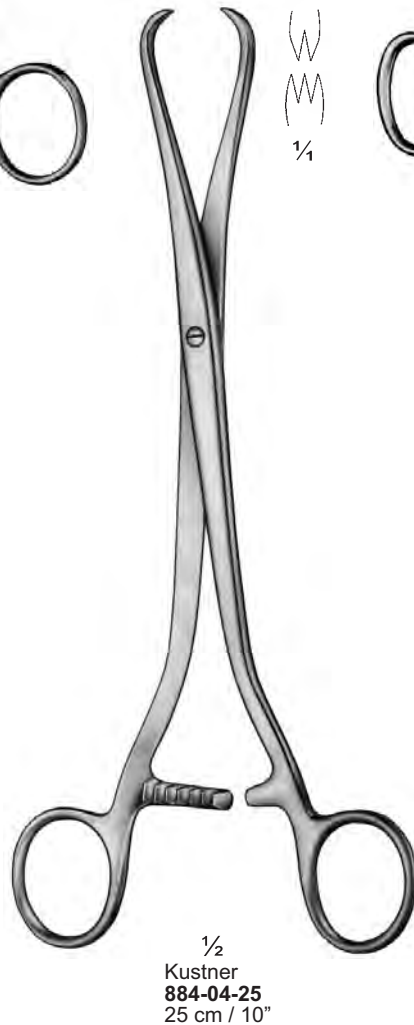
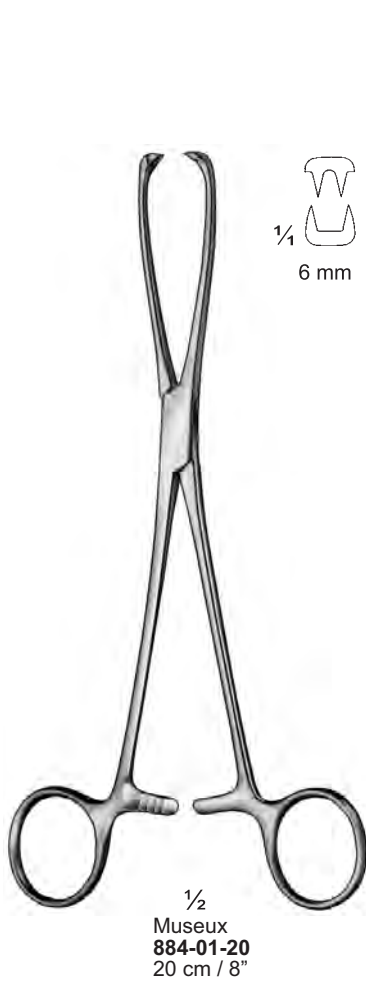

Hakenzangen
Uterine Tenaculum Forceps
Pince pour le col delutérus

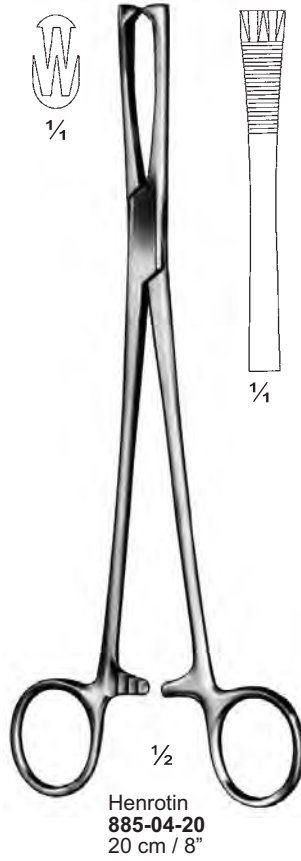
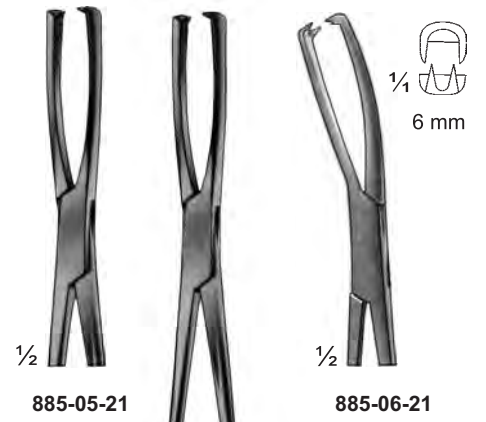

Hakenzangen Uterine Tenaculum Forceps Pince pour le col delutérus

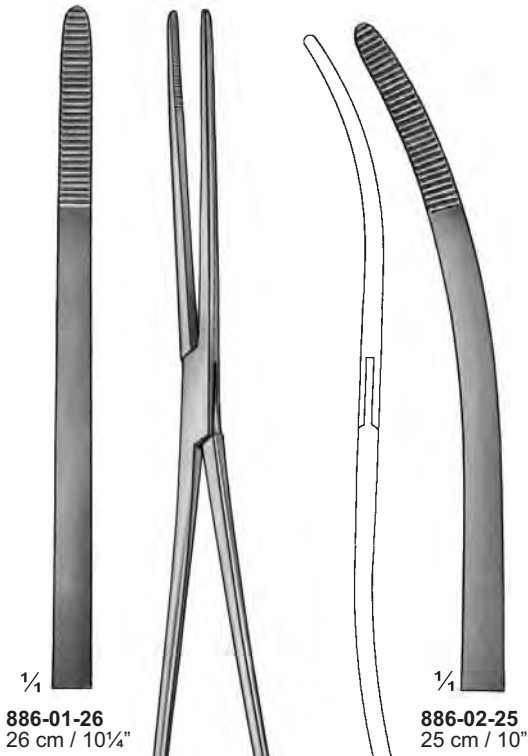

Bozemann
886-01-26 & 886-02-25

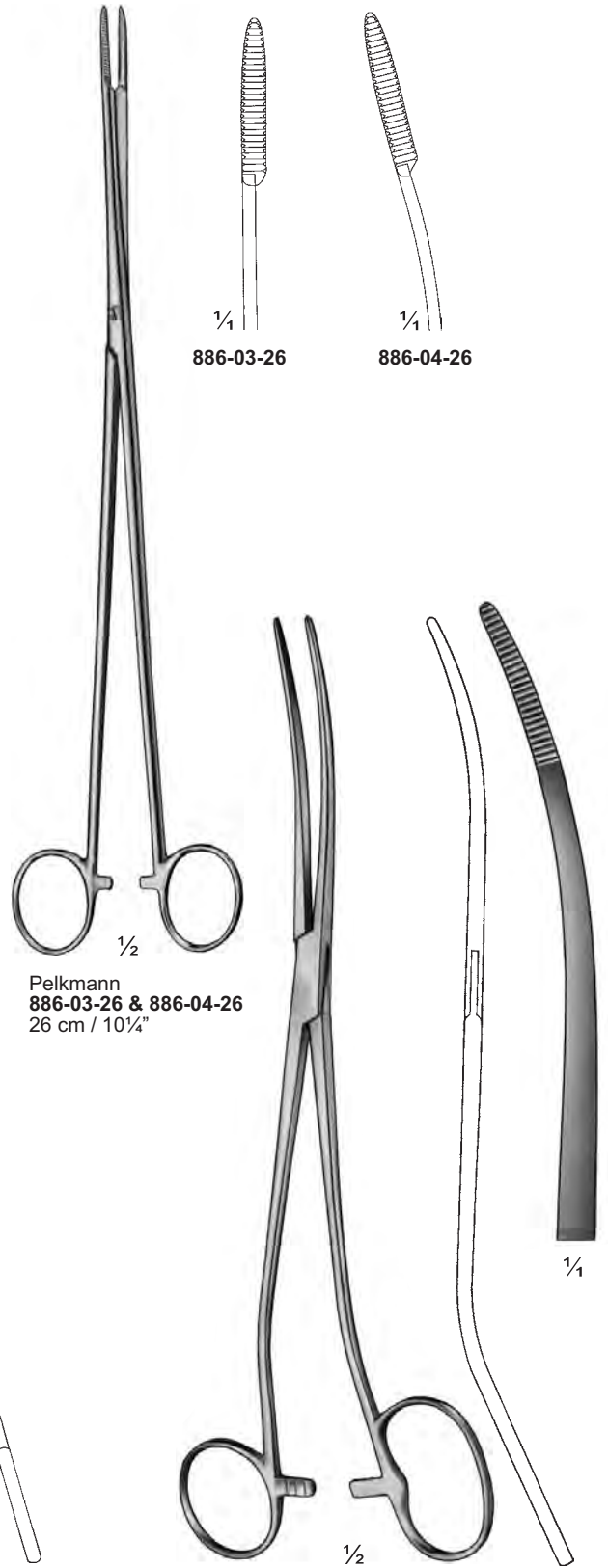
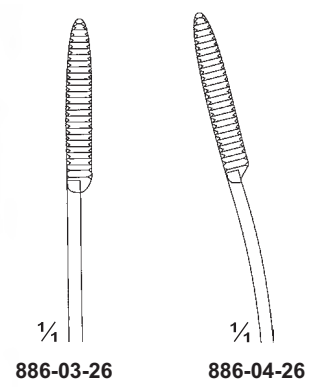

Hakenzangen
Uterine Tenaculum Forceps
Pince pour le col delutéus



1/2
 Blumenthal
887-01-29
 29 cm / 11½"
 Dressing forceps

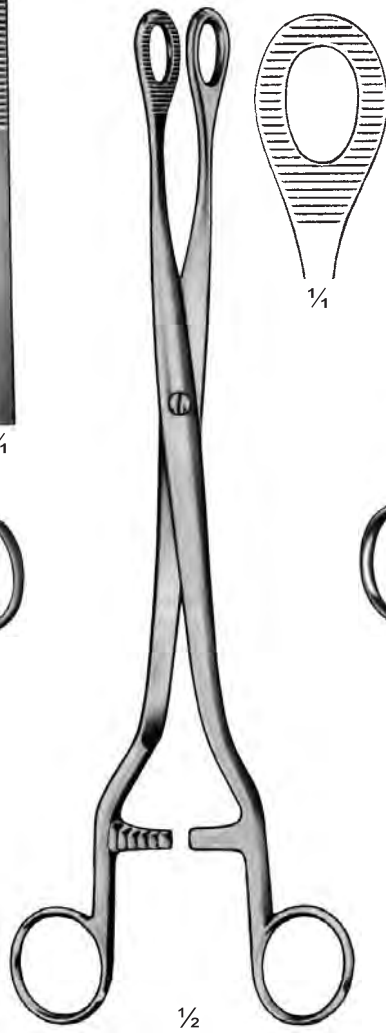

1/2
 Noto
887-03-27
 27 cm / 10½"



1/2
 Kelly
887-02-32
 32 cm / 12½"



1/2
 Bumm
887-04-28
 28 cm / 11"

**Uterus-Ploypenzangen
Uterine Polypus Forceps
Pincès à polypes utérins**

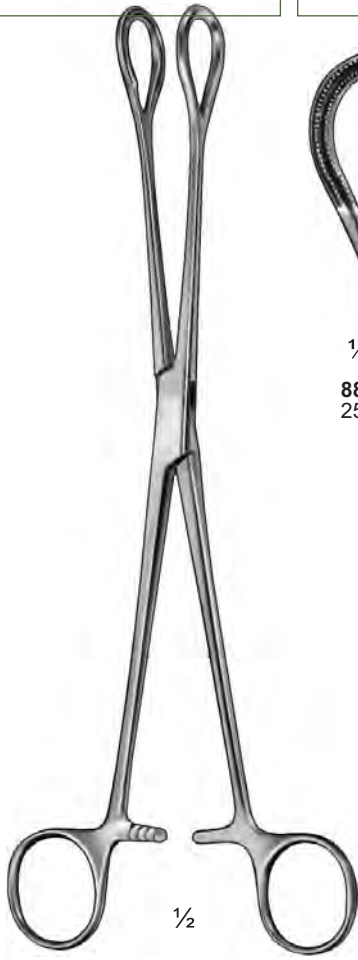

1/2

888-01-25 & 888-02-27



1/4
888-01-25
25 cm / 10"



1/4
888-02-27
27 cm / 10 1/2"

ATRAUMA TOOTHED

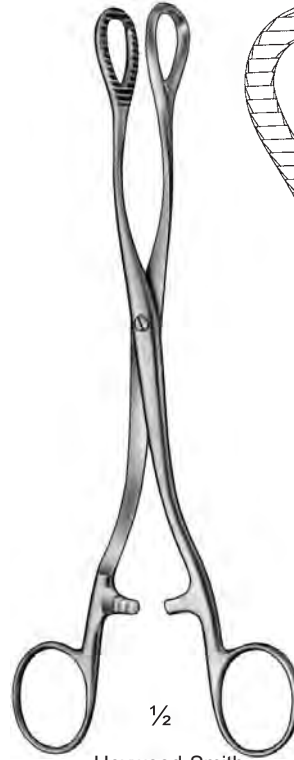

1/2

Heywood-Smith
888-03-20
20 cm / 8"

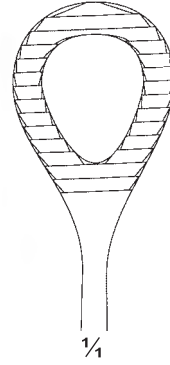

1/4



1/2

Doyen
888-04-20
20 cm / 8"

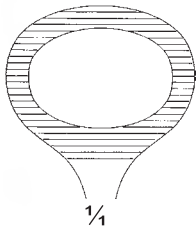

1/4

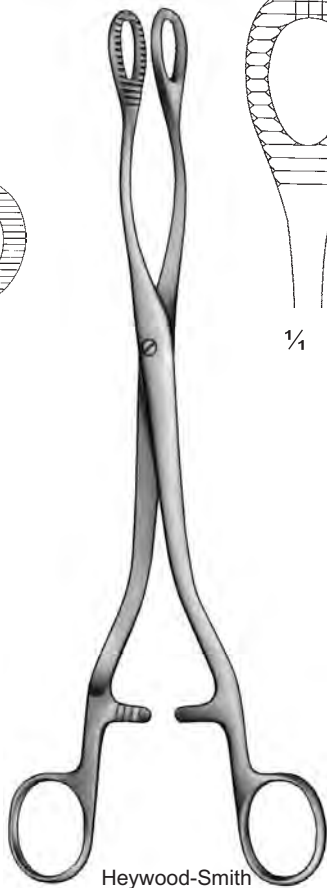

1/4

Heywood-Smith
888-05-25
25 cm / 10"

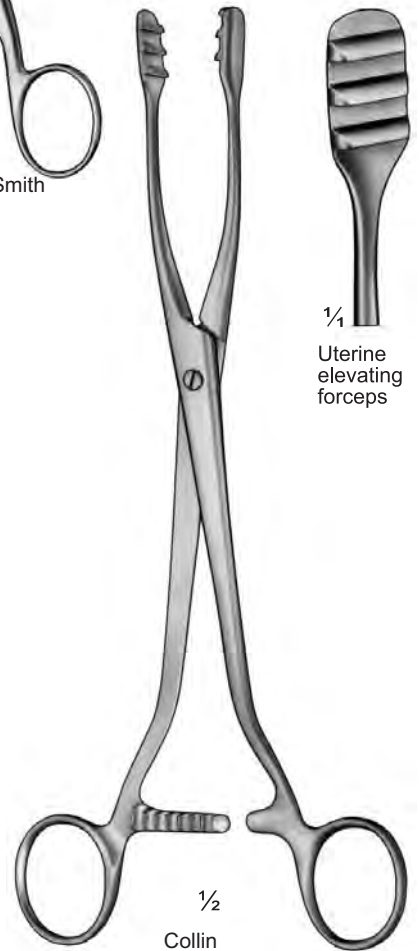

1/2

Collin
888-06-25
25 cm / 10"



1/4

Uterine elevating forceps



$\frac{1}{2}$
Strassmann
889-01-27
27 cm / 10 $\frac{1}{2}$ "

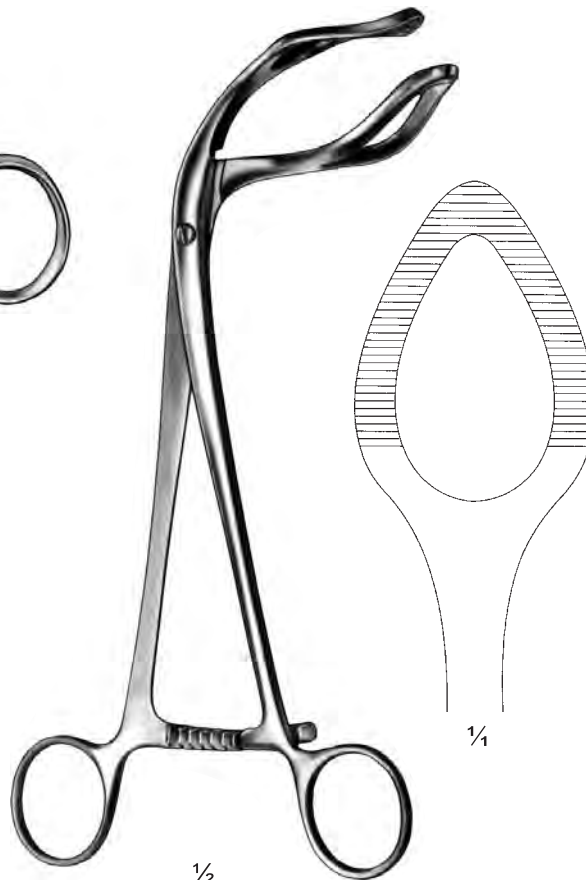

$\frac{1}{2}$
Sommer
889-02-23
23 cm / 9"



$\frac{1}{2}$
Sommer
889-03-28
28.5 cm / 11 $\frac{1}{4}$ "

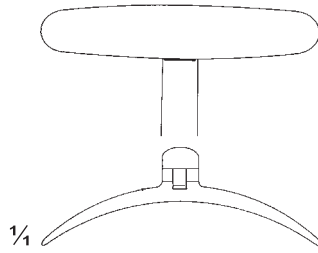
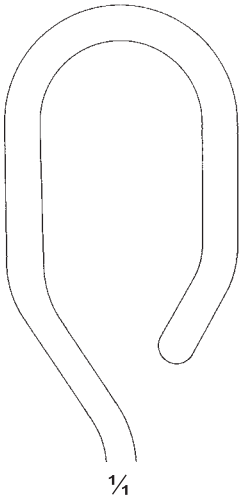

1/2
Dartigues
890-01-27
27 cm / 10 1/2"



1/2
Collin
890-02-25
25 cm / 10"
With moveable jaws



Collin
890-03-25
25 cm / 10"
With moveable jaws

**Uterusfasazange
Uterine Seizing Forceps
Pincès hystérolabes**

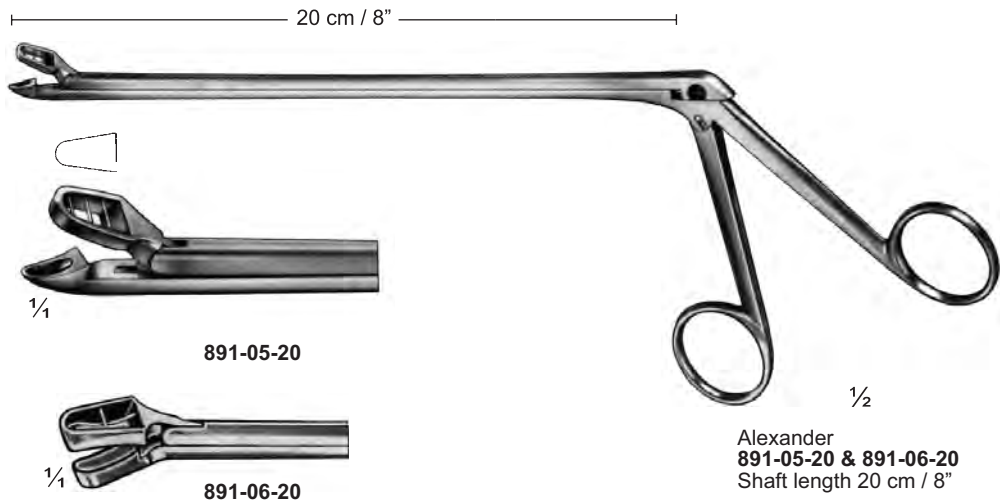
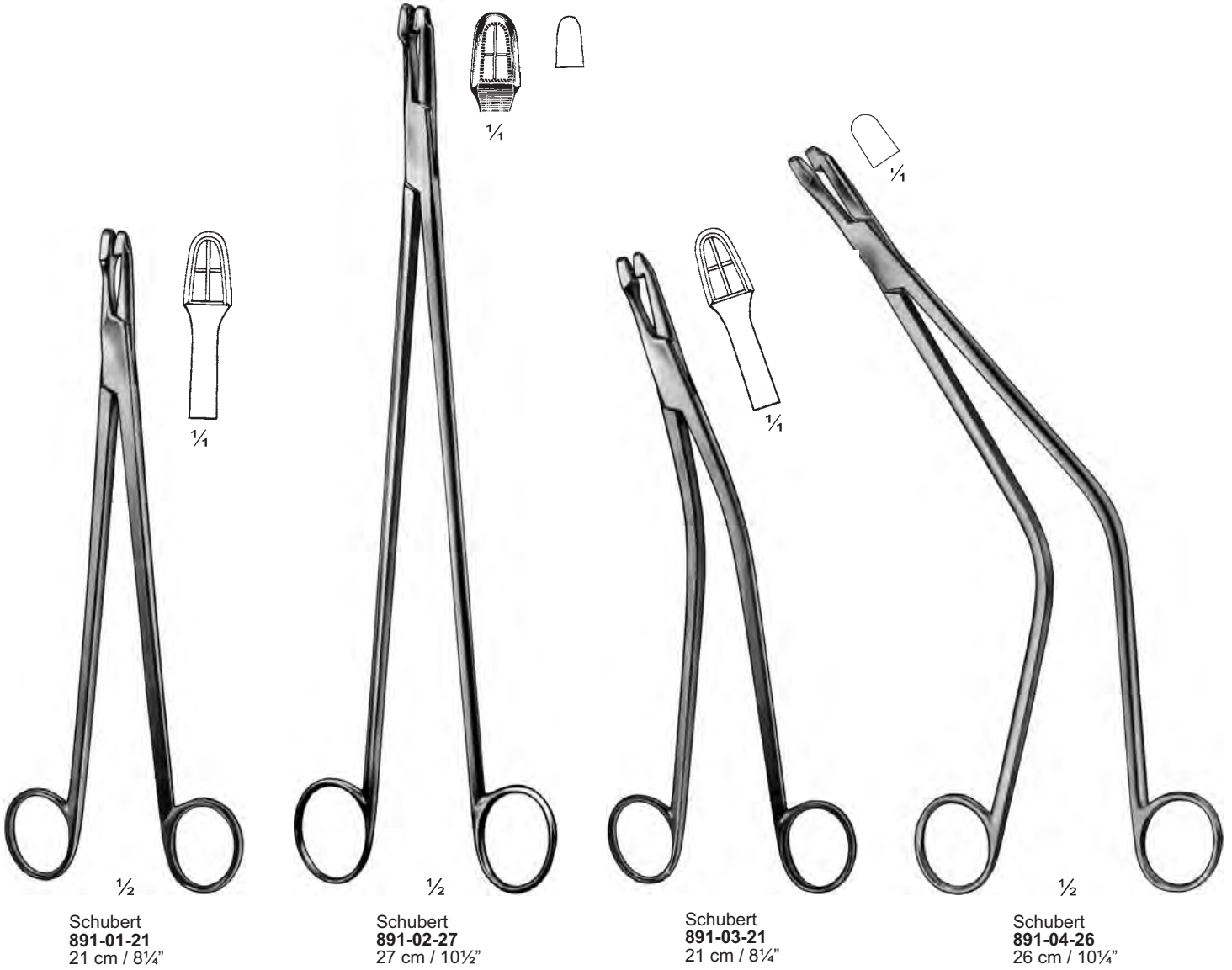

Uterusfasazange
Uterine Seizing Forceps
Pinces hystérolabes



Schubert
892-01-23 Str
892-02-23 Sideways cur
 23.5 cm / 9 $\frac{1}{4}$ "



892-03-24
 4 mm

892-04-24
 6 mm

Schumacher-Van Doren
892-03-24 & 892-04-24
 24 cm / 9 $\frac{1}{2}$ "



Van Doren
892-05-25
 25 cm / 10"

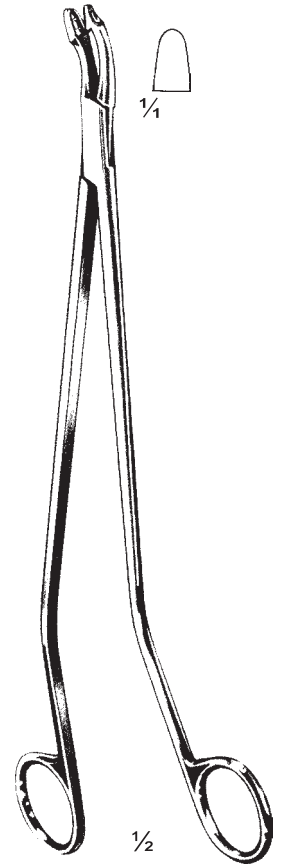

Van Doren
892-06-27
 27 cm / 10 $\frac{1}{2}$ "

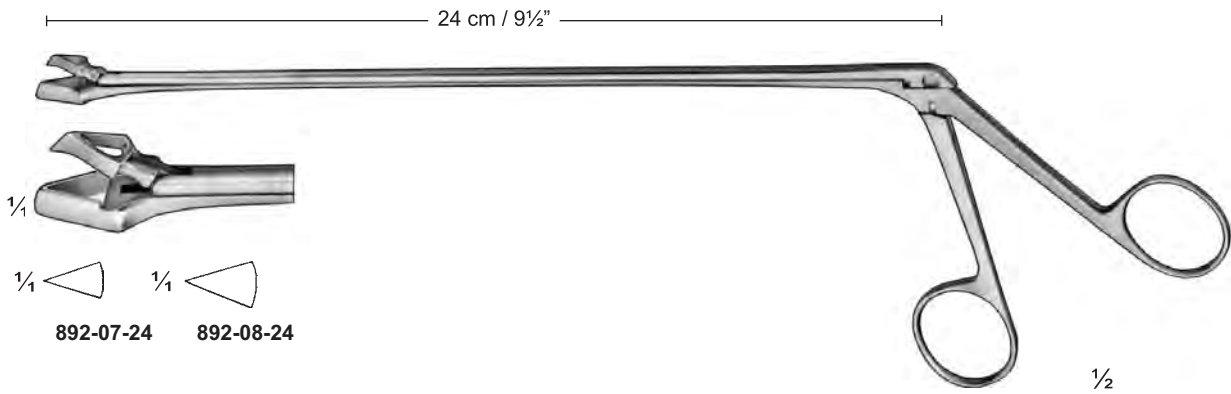

892-07-24 **892-08-24**

Schumacher
892-07-24 & 892-08-24
 Shaft length 24 cm / 9 $\frac{1}{2}$ "

**Uterusfasazange
Uterine Seizing Forceps
Pincès hystérolabes**

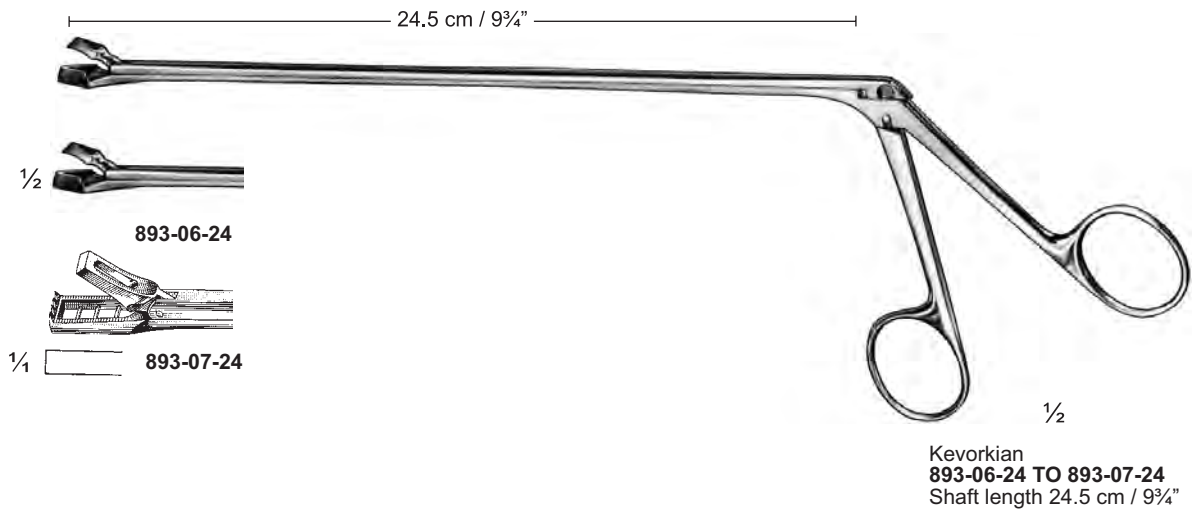
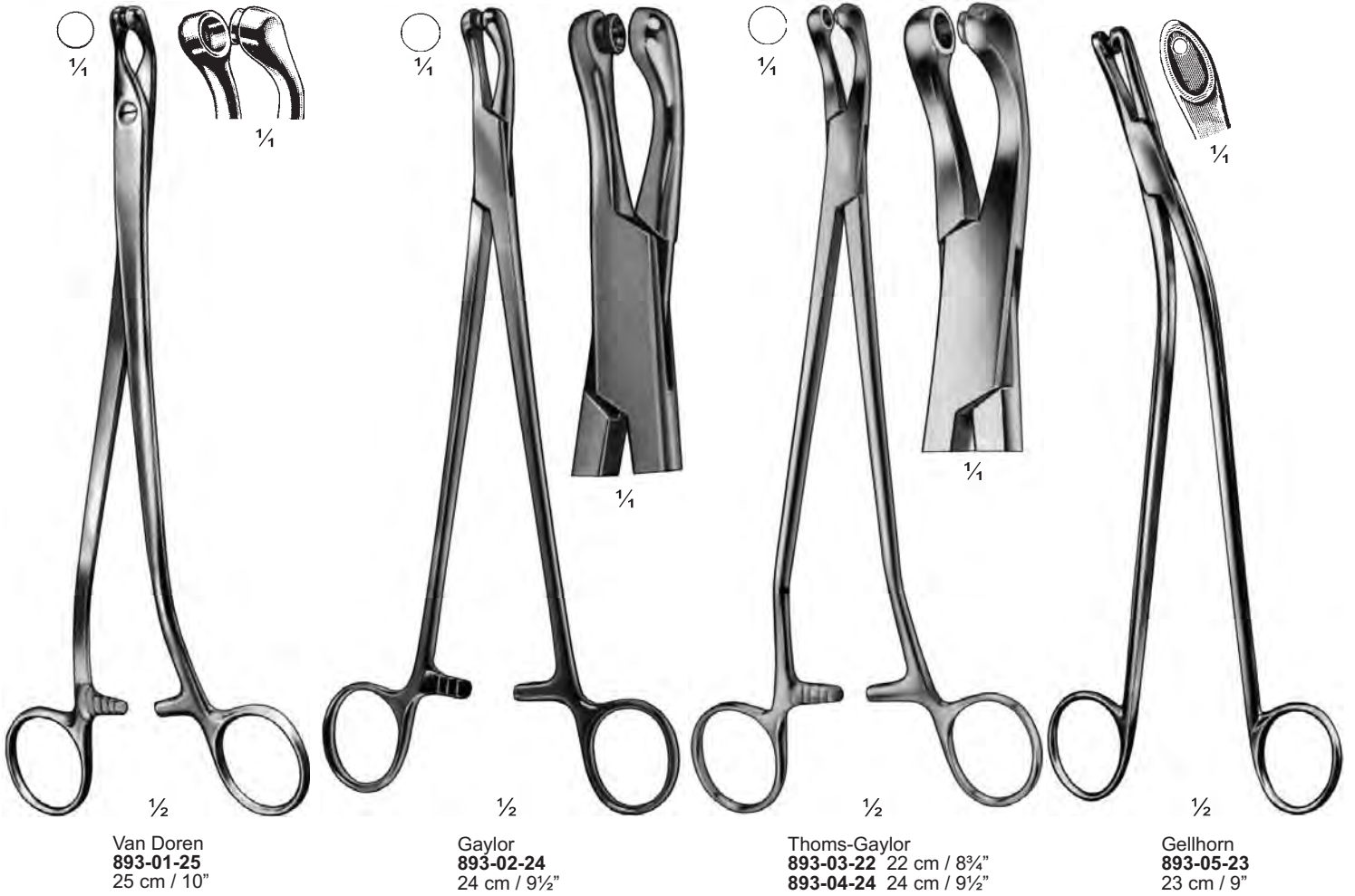

**Uterusfasazange
Uterine Seizing Forceps
Pincés hystérolabes**

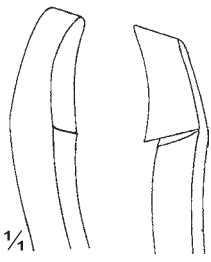

1/1

Gothic shape



1/1



1/1

894-01-24
2 mm



1/1

894-02-24
2.4 mm

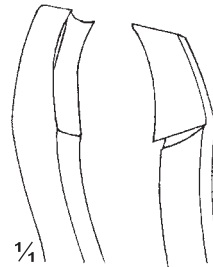

1/1

Rectangular shape



1/1



1/1

894-03-24
2.4 mm

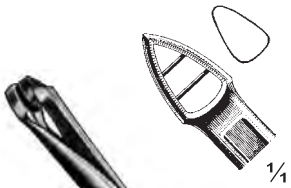

1/1



1/2

Faure
894-04-21 21 cm / 8 1/4"
894-05-24 24 cm / 9 1/2"

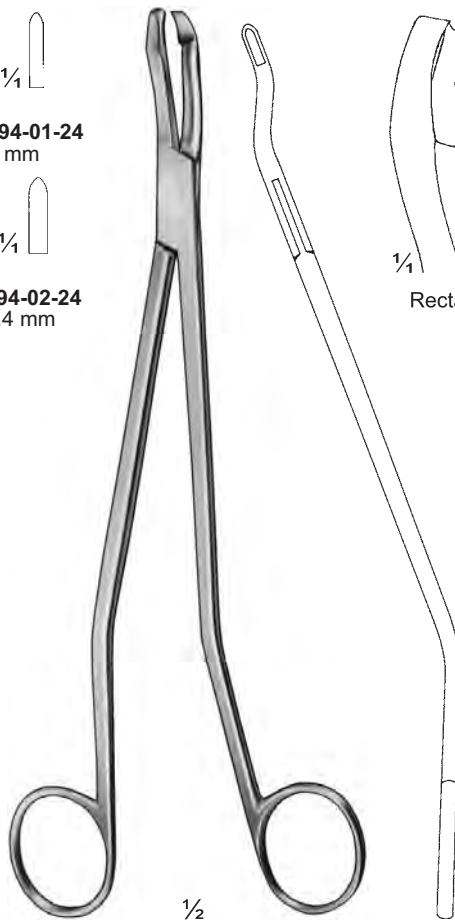

1/2

Seidl
894-01-24 To 894-03-24
24 cm / 9 1/2"
Bayonet shaped,
for portio, vagina and vulva



1/1



1/1



1/2

Tischler
894-06-27
27 cm / 10 1/2"

**Uterusfasazange
Uterine Seizing Forceps
Pincés hystérolabes**

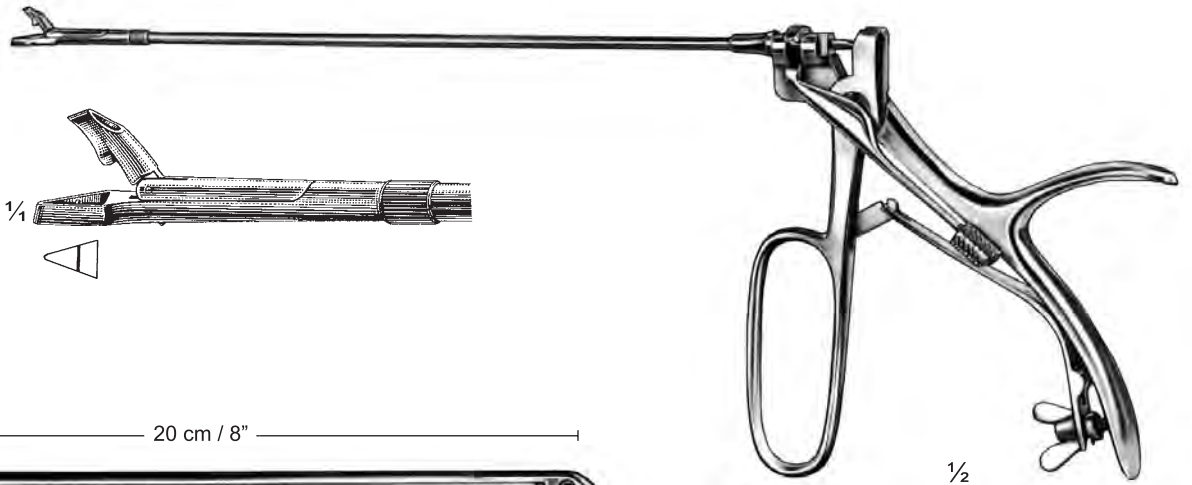

**Schumacher
895-01-00**
With removeable tip

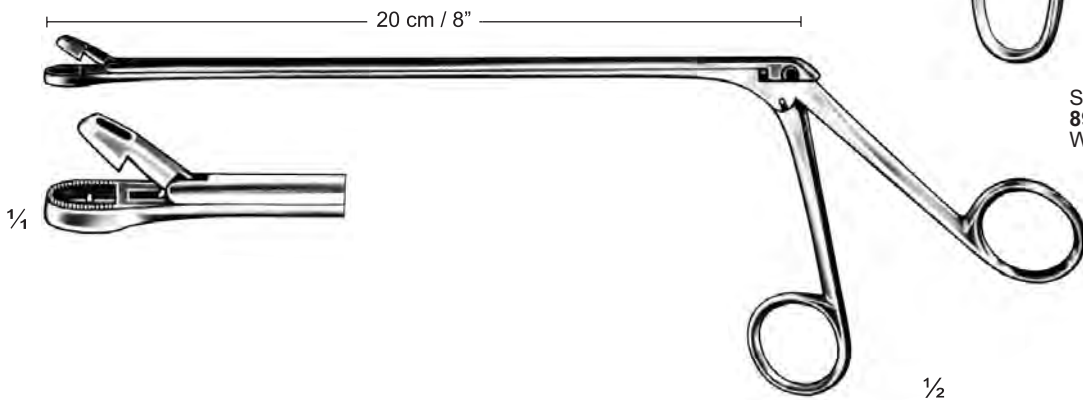

**Appendorf
895-02-20** Shaft length 20 cm / 8"
895-03-23 Shaft length 23 cm / 9"

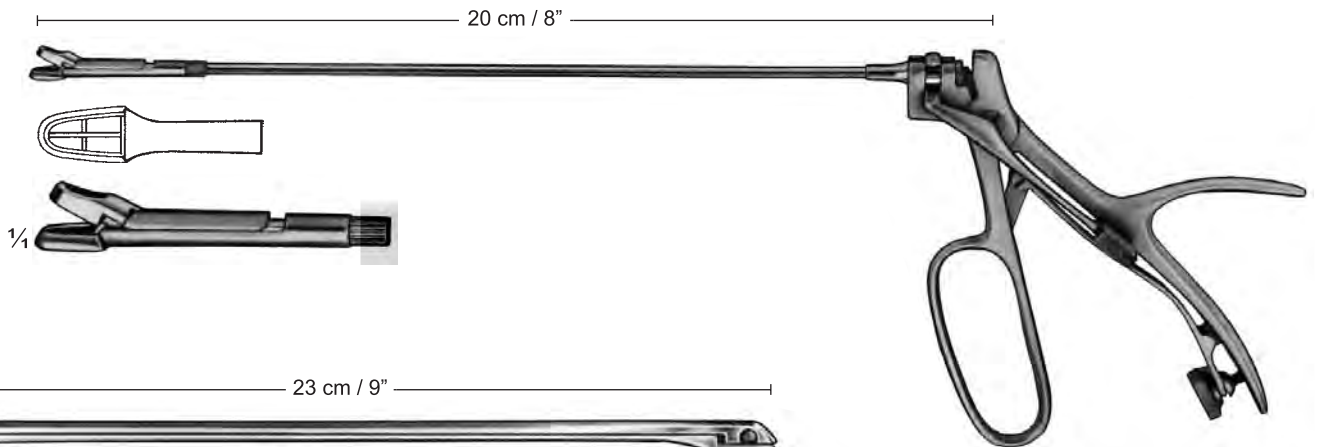

**Eppendorf
895-04-20**
Shaft length 20 cm / 8"

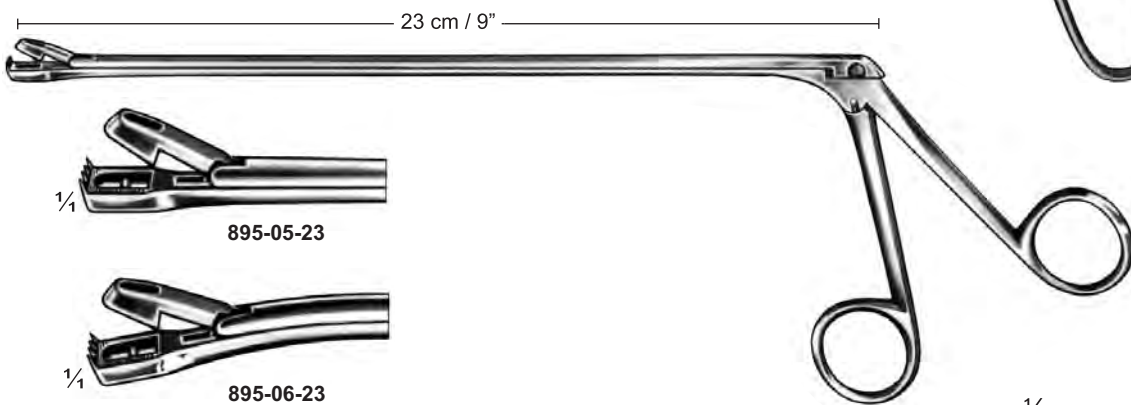

**Wittner
895-05-23 & 895-06-23**
Shaft length 23 cm / 9"

Uterusfasazange Uterine Seizing Forceps Pincés hystérolabes

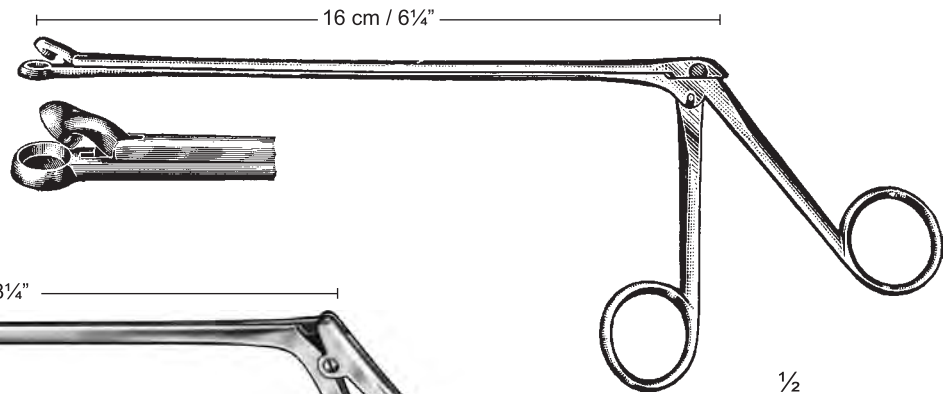

1/2
Swiss Mod.
896-01-16
Shaft length 16 cm / 6 1/4"

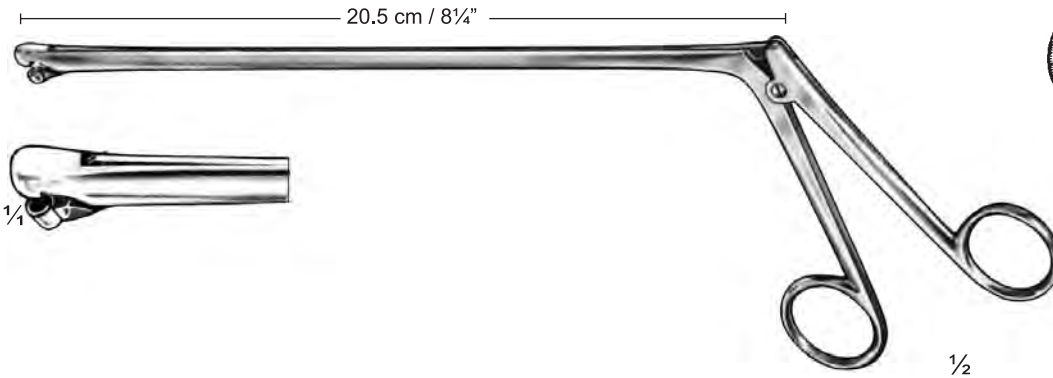

1/2
Berger
896-02-20
Shaft length 20.5 cm / 8 1/4"

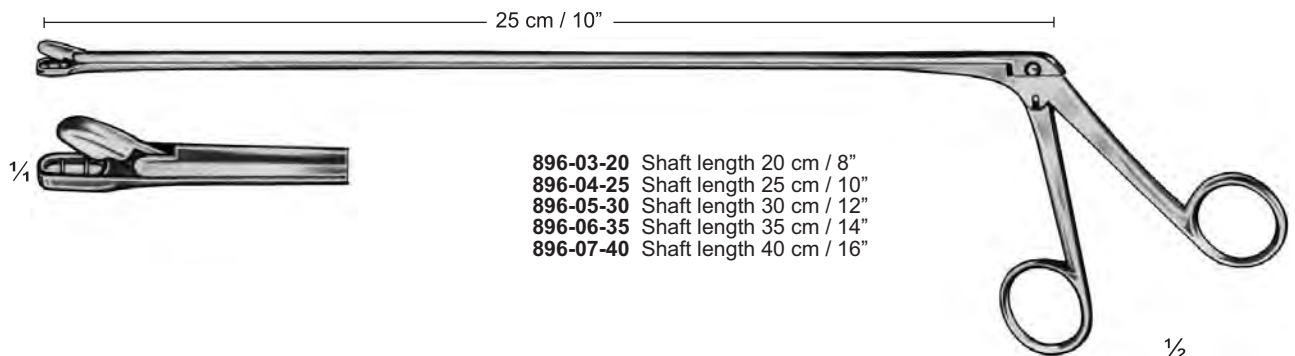

1/2
896-03-20 Shaft length 20 cm / 8"
896-04-25 Shaft length 25 cm / 10"
896-05-30 Shaft length 30 cm / 12"
896-06-35 Shaft length 35 cm / 14"
896-07-40 Shaft length 40 cm / 16"

1/2
Douay
896-03-20 To 896-07-40

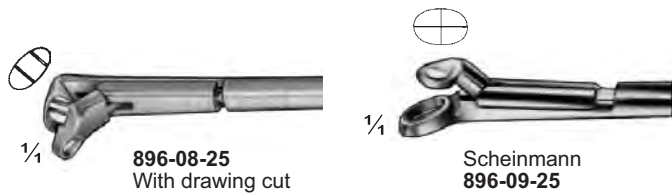

1/4
896-08-25
With drawing cut

1/4
Scheinmann
896-09-25

1/4 ⊕ 1/4 ⊕
896-10-25 896-11-25

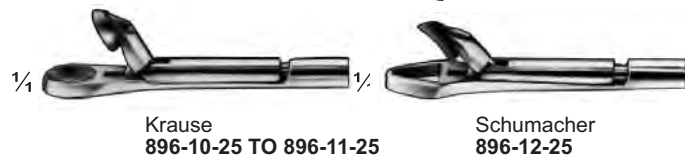

1/4
Krause
896-10-25 TO 896-11-25

1/4
Schumacher
896-12-25
With drawing cut

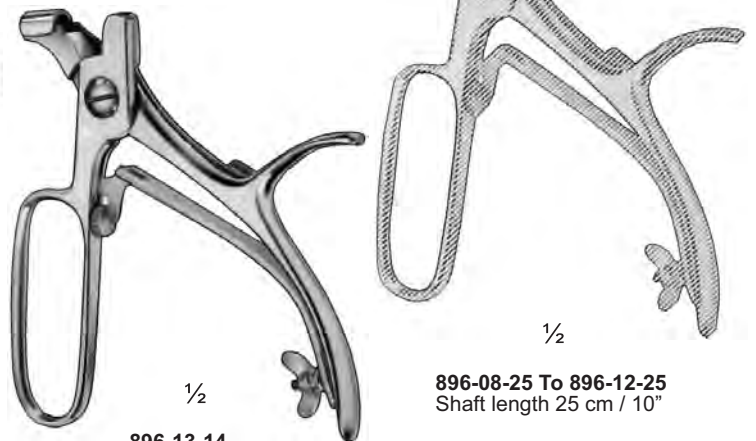

1/2
896-13-14
14 cm / 5 1/2"

1/2
896-08-25 To 896-12-25
Shaft length 25 cm / 10"

Uterusfasazange Uterine Seizing Forceps Pincés hystérolabes

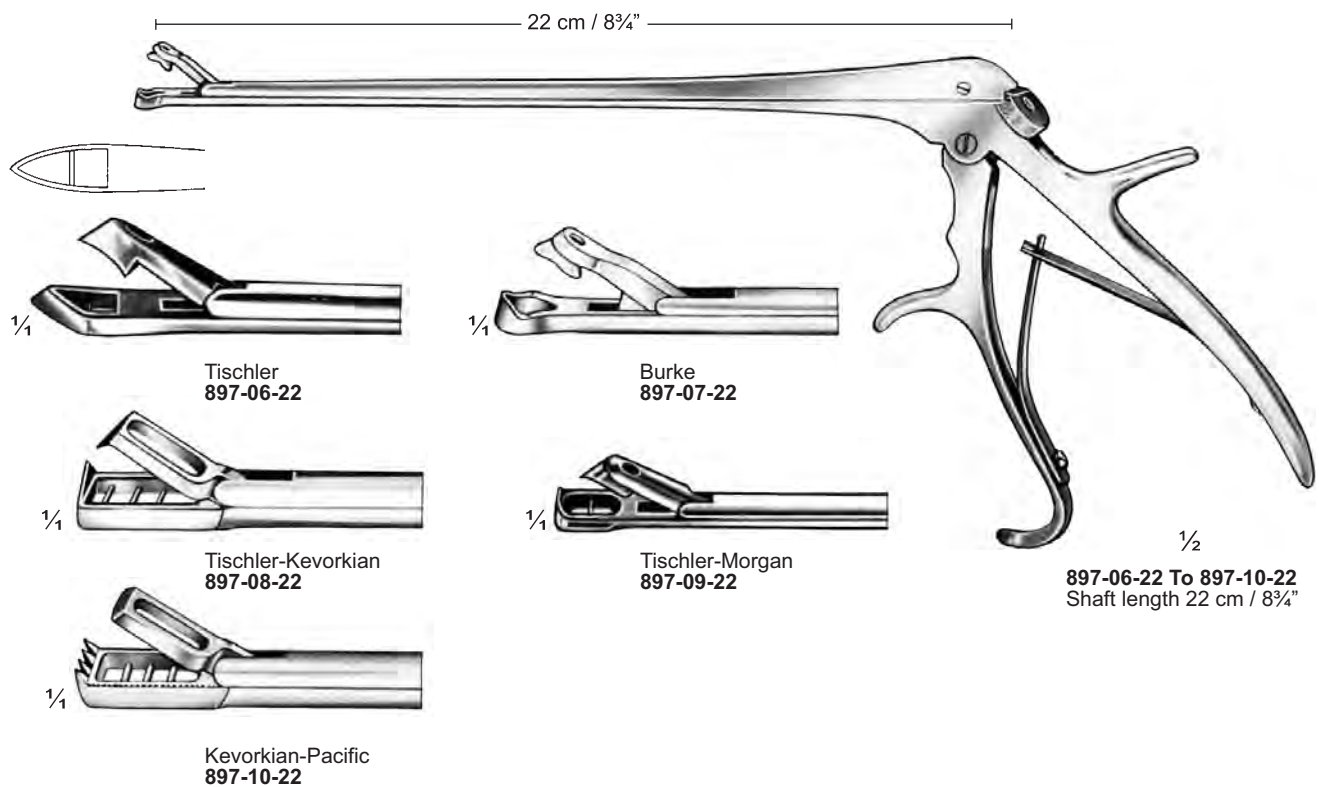
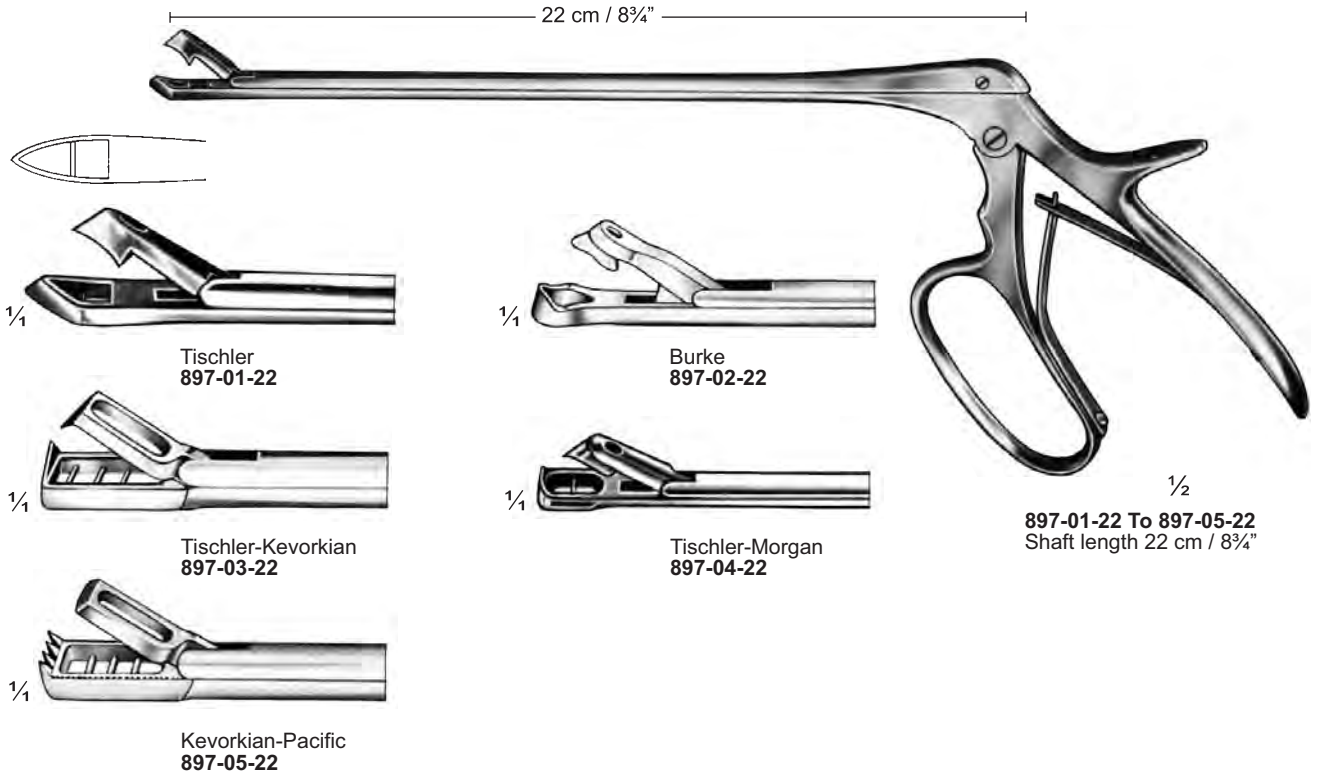

Uterusfasazange Uterine Seizing Forceps Pincés hystérolabes

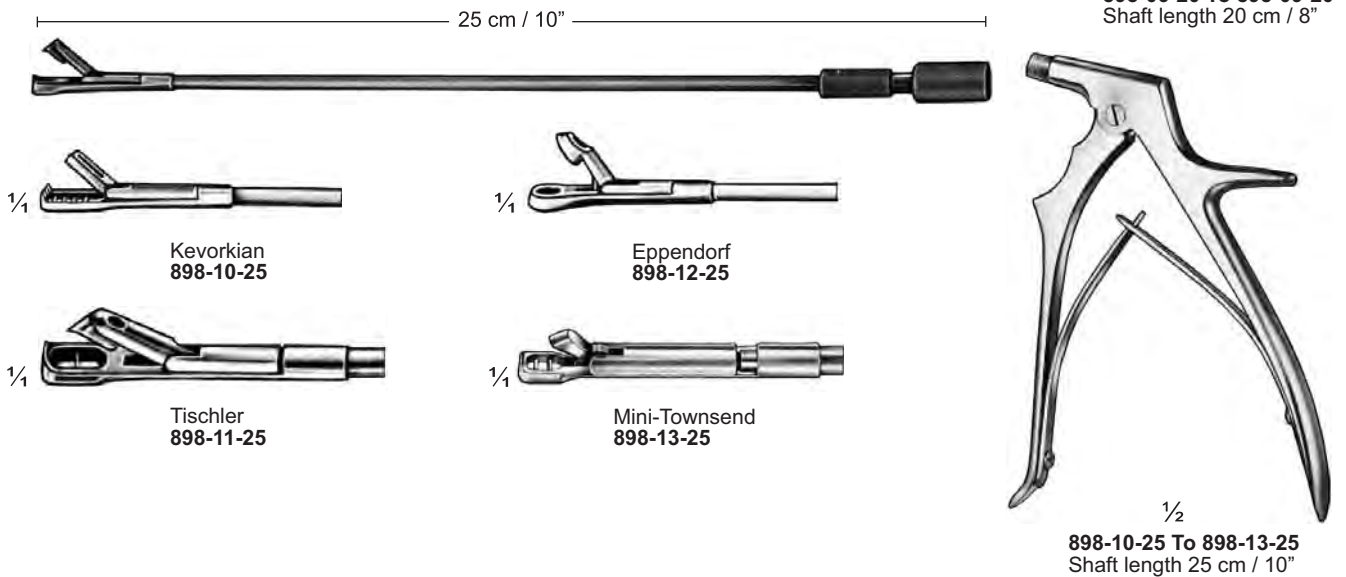
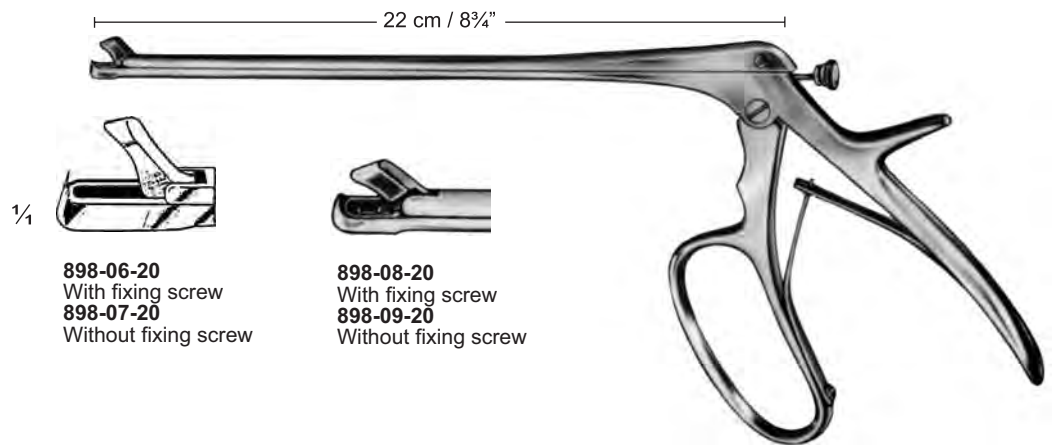
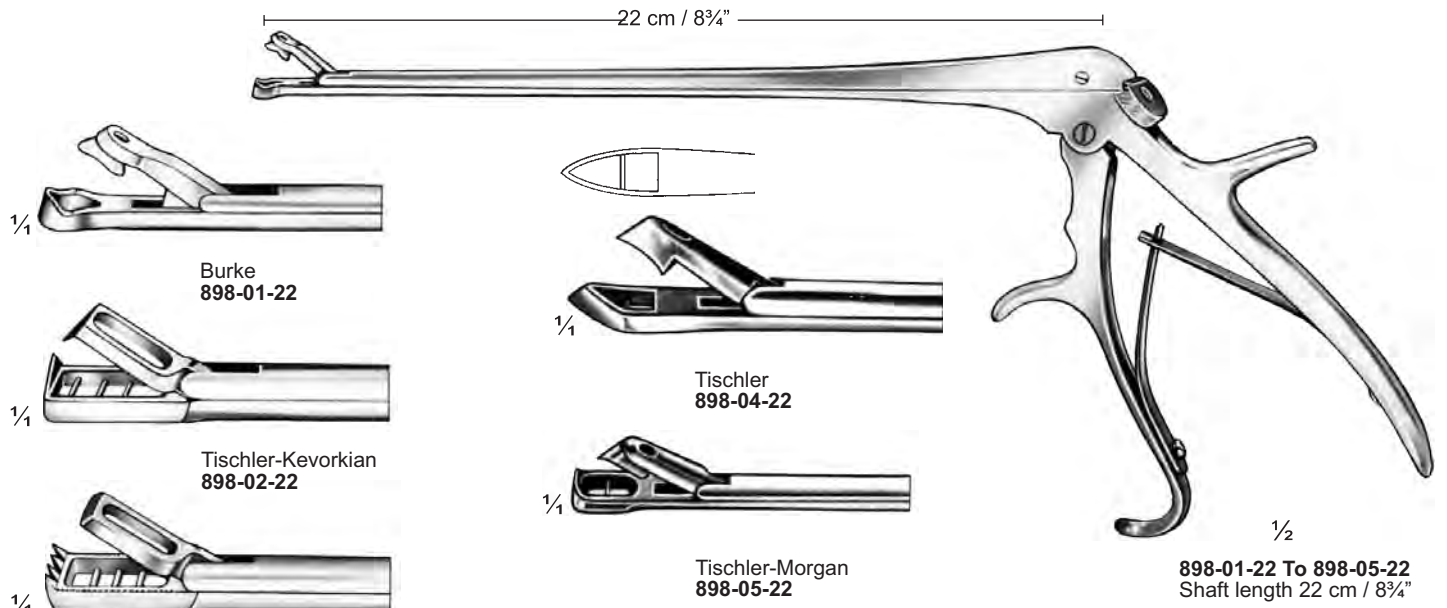

**Myomheber, Myommesser
Myoma Screws, Myoma Knife
Tracteurs pour fibromes, Evideur de fibromes**



1/2
Segond
899-01-27
27 cm / 10 1/2"



1/4



1/2
Segond
899-02-27
27 cm / 10 1/2"

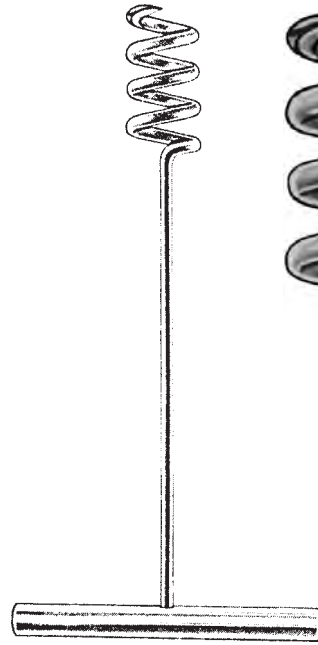

1/2
Doyen
899-03-17
17 cm / 6 3/4"
Ø 20 mm

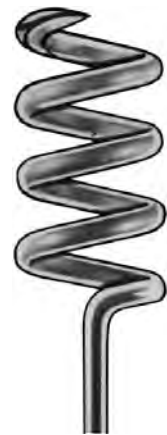

1/4

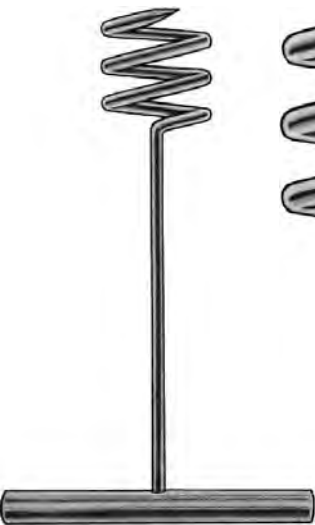

1/2
Doyen
899-04-14
14 cm / 5 1/2"
Ø 29 mm

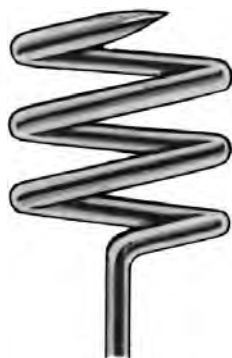

1/4



1/4
899-05-20
Ø 6 mm



1/4
899-06-20
Ø 8 mm



1/4
899-07-20
Ø 10 mm



1/2
Neubuser
899-05-20 To 899-07-20
20 cm / 8"
Tubal seizing forceps

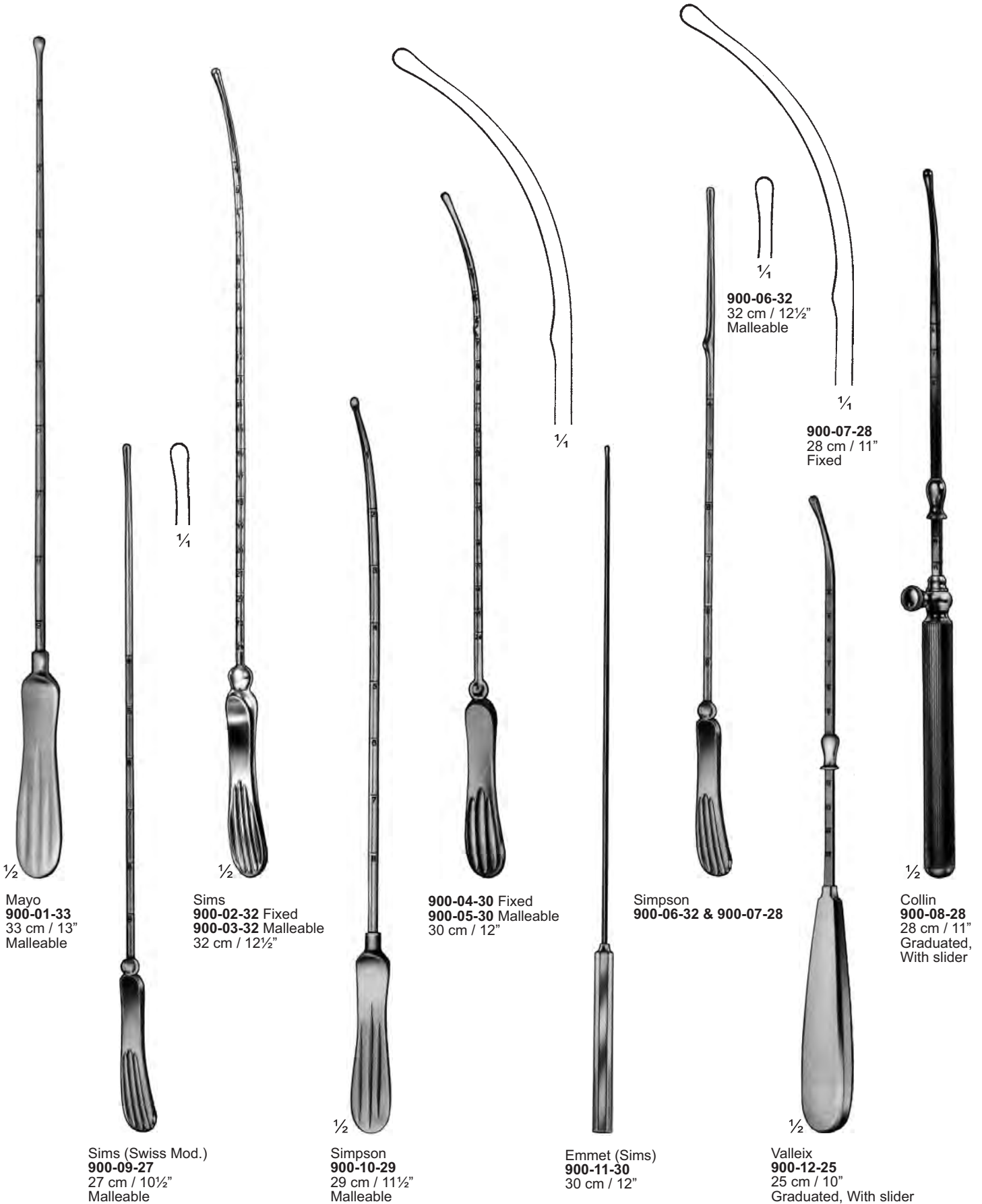

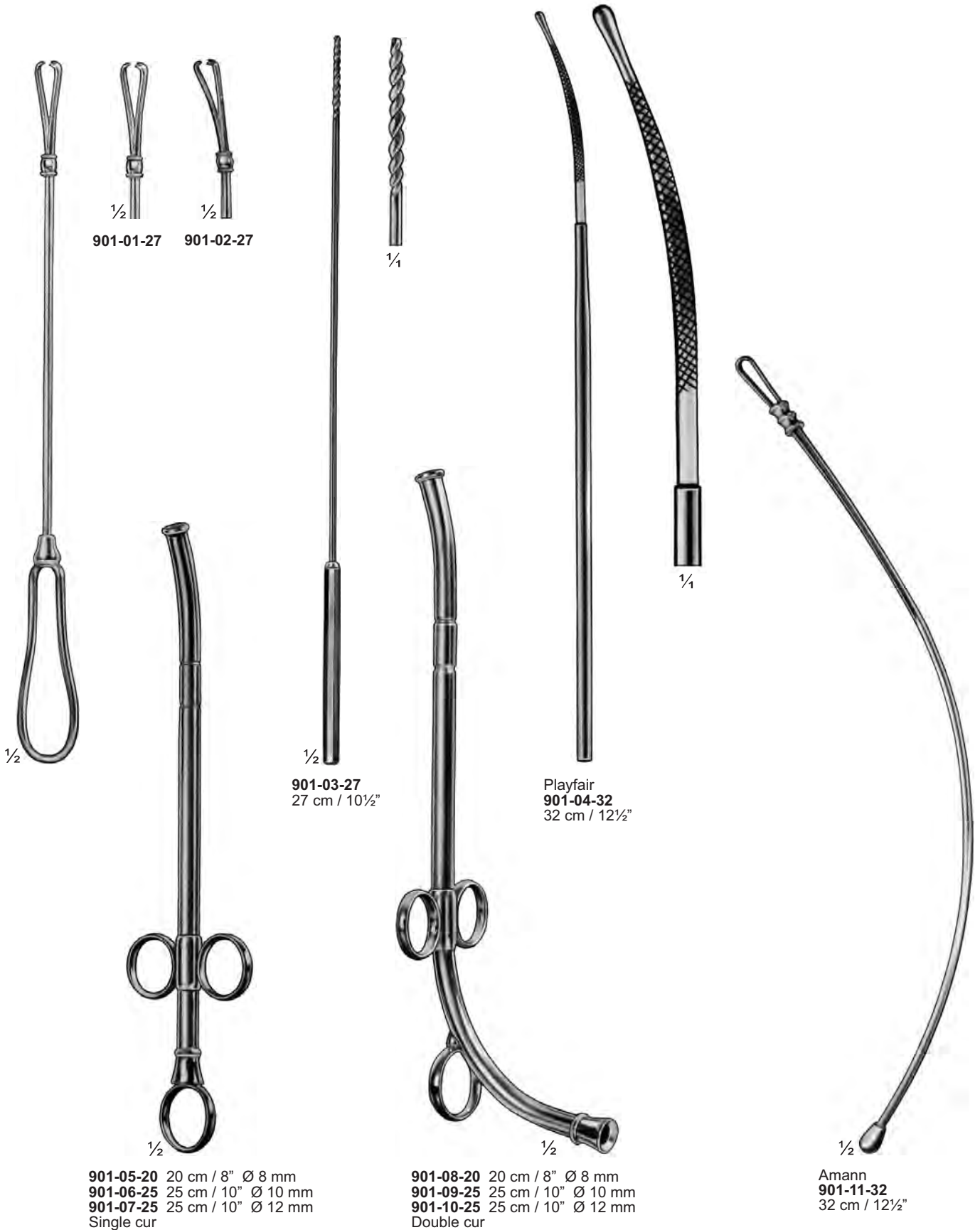

**Gebärmutter Depressors
Uterine Depressors
Uterin Depressors**

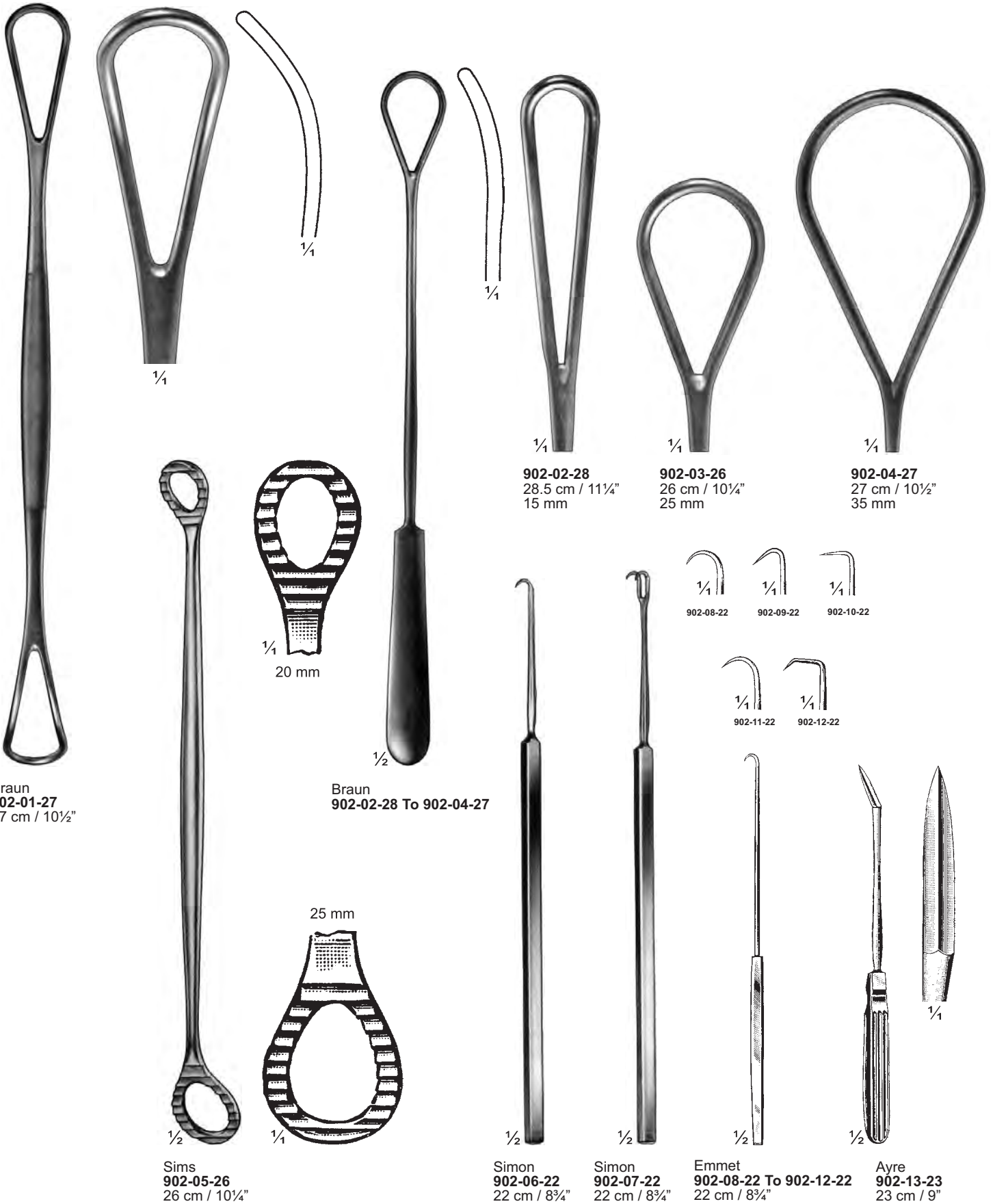

Uterusdilatatoren Uterine Dilators Dilatateurs du col de l'utérus



Ø mm	
903-01-01	1.0
903-02-02	2.0
903-03-03	3.0
903-04-04	4.0
903-05-05	5.0
903-06-06	6.0
903-07-07	7.0
903-08-08	8.0
903-09-09	9.0
903-10-10	10.0
903-11-11	11.0
903-12-12	12.0
903-13-13	13.0
903-14-14	14.0
903-15-15	15.0
903-16-16	16.0
903-17-17	17.0
903-18-18	18.0
903-19-19	19.0
903-20-20	20.0
903-21-21	21.0
903-22-22	22.0
903-23-23	23.0
903-24-24	24.0
903-25-25	25.0
903-26-26	26.0

Hegar
903-01-01 To 903-48-22
18 cm / 7"

With sloped handle

903-49-26 Set of 26 pcs (903-01-01 To 903-26-26)

903-50-17 Set of 17 pcs (903-27-01 To 903-43-17)

903-51-22 Set of 22 pcs (903-27-01 To 903-48-22)

Ø mm	
903-27-01	1.5
903-28-02	2.5
903-29-03	3.5
903-30-04	4.5
903-31-05	5.5
903-32-06	6.5
903-33-07	7.5
903-34-08	8.5
903-35-09	9.5
903-36-10	10.5
903-37-11	11.5
903-38-12	12.5
903-39-13	13.5
903-40-14	14.5
903-41-15	15.5
903-42-16	16.5
903-43-17	17.5
903-44-18	18.5
903-45-19	19.5
903-46-20	20.5
903-47-21	21.5
903-48-22	22.5

Hegar
903-52-01 To 903-99-22
16 cm / 6 1/4"

With grooved handle

903-100-26 Set of 26 pcs (903-52 To 903-77)

903-101-17 Set of 17 pcs (903-78 To 903-94)

903-102-22 Set of 22 pcs (903-78 To 903-99)



Hegar
903-103-26 Set of 26 pcs (903-01 To 903-26 or 903-52 To 903-77)
903-104-17 Set of 17 pcs (903-27 To 903-43 or 903-78 To 903-94)
903-105-22 Set of 22 pcs (903-27 To 903-48 or 903-78 To 903-99)
Packed in metal case 330 X 220 X 80 mm

**Uterusdilatatoren
Uterine Dilators
Dilatateurs du col de l'utérus**



1/2

	Ø mm
904-01-01	1.0/2.0
904-02-03	3.0/4.0
904-03-05	5.0/6.0
904-04-07	7.0/8.0
904-05-09	9.0/10.0
904-06-11	11.0/12.0
904-07-13	13.0/14.0
904-08-15	15.0/16.0
904-09-17	17.0/18.0
904-10-19	19.0/20.0
904-11-21	21.0/22.0
904-12-23	23.0/24.0
904-13-25	25.0/26.0



1/2

1/2

1/2

1/2

1/2

1/2

1/2

1/2

Hegar
904-01-01 To 904-13-25
19 cm / 7 1/2"

Hegar
904-14-08
Set of 8 pcs (904-02-03 To 904-09-17)



Hegar
904-15-8
Set of 8 pcs (904-02-03 To 904-09-17)
Packed in canvas roll



Hegar
904-16-13
Set of 13 pcs (904-01-01 To 904-13-25)
Packed in metal case with hinged lid

Uterusdilatatoren Uterine Dilators Dilatateurs du col de l'utérus



Hank
905-08-06 Packed in metal case
905-09-06 Packed in canvas roll
 Set of 6 pcs (905-01-05 To 905-06-10)

Hank 905-01-5 Fig 9/10 Ø 4.5/5 mm	Hank 905-02-6 Fig 11/12 Ø 5.5/6 mm	Hank 905-03-7 Fig 13/14 Ø 6.5/7 mm	Hank 905-04-8 Fig 15/16 Ø 7.5/8 mm	Hank 905-05-9 Fig 17/18 Ø 8.5/9 mm	Hank 905-06-10 Fig 19/20 Ø 9.5/10 mm
---	--	--	--	--	--

905-07-06 Set of 6 pcs (905-01-05 To 905-06-10)
26 cm / 10 1/4"

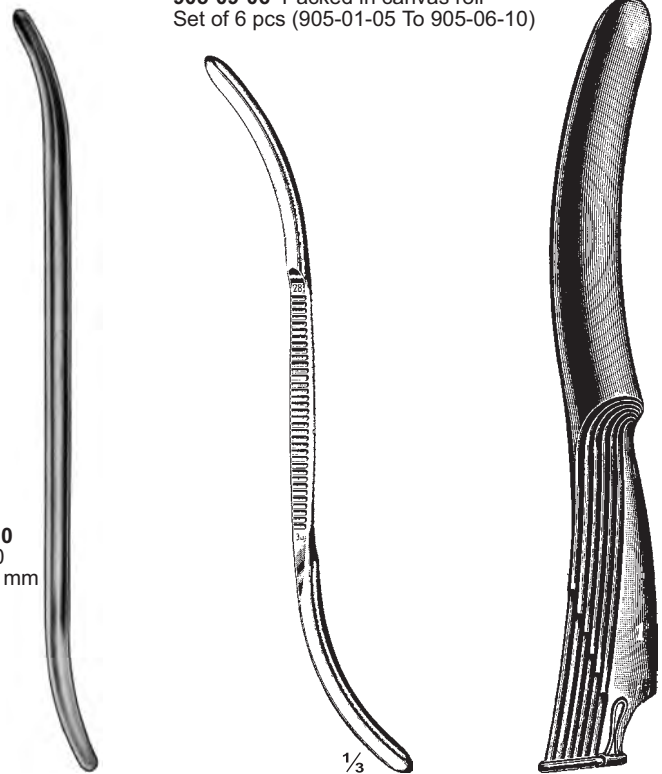

Pratt
905-10-05 Ø 4.5/5 mm
905-11-06 Ø 5.6/6.3 mm
905-12-07 Ø 7.0/7.6 mm
905-13-09 Ø 8.3/9 mm
905-14-10 Ø 9.6/10.3 mm
905-15-11 Ø 11/11.6 mm
905-16-13 Ø 12.3/13 mm
905-17-14 Ø 13.6/14.3 mm

905-18-08
Set of 8 pcs
(905-10-05 To 905-17-14)

Pratt
905-19-05 Ø 4.5/5 mm
905-20-06 Ø 5.5/6 mm
905-21-07 Ø 6.5/7 mm
905-22-08 Ø 7.5/8 mm
905-23-09 Ø 8.5/9 mm
905-24-10 Ø 9.5/10 mm

905-25-06
Set of 6 pcs
(905-19-05 To 905-25-10)

Jolly
905-26-07 Ø 3/7 mm
905-27-09 Ø 5/9 mm
905-28-12 Ø 7/12 mm
905-29-15 Ø 9/15 mm
905-30-18 Ø 12/18 mm
905-31-21 Ø 15/21 mm
905-32-24 Ø 18/24 mm

905-33-05
Set of 5 pcs
(905-26-07 To 905-30-18)
905-34-07
Set of 7 pcs
(905-26-07 To 905-32-24)

**Uterusdilatatoren
Uterine Dilators
Dilatateurs du col de l'utérus**



$\frac{1}{2}$
Sims
906-01-29
29 cm / 11½"



$\frac{1}{2}$
Goodell
906-02-28 28 cm / 11"
906-03-34 34 cm / 13½"

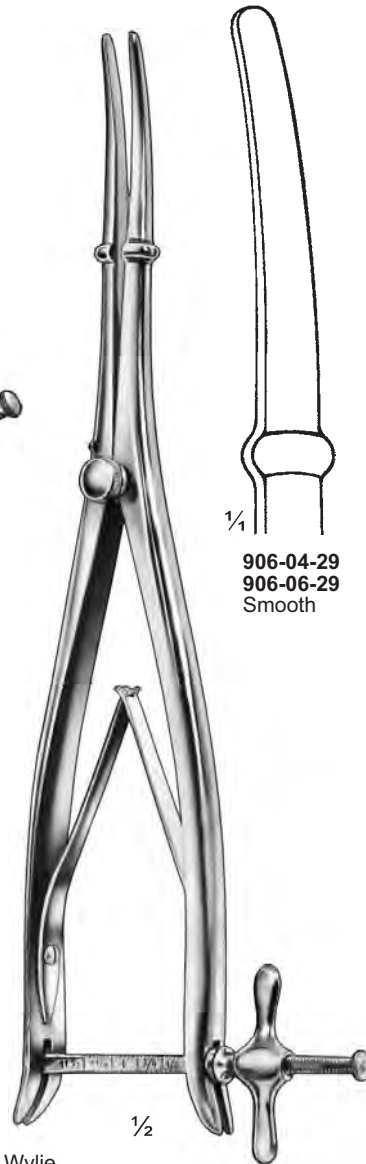

$\frac{1}{2}$
Wylie
906-04-29 TO 906-05-29
29 cm / 11½"



$\frac{1}{4}$
906-04-29
906-06-29
Smooth



$\frac{1}{4}$
906-05-29
906-07-29
Grooved



$\frac{1}{2}$
Wylie
906-06-29 TO 906-07-29
29 cm / 11½"

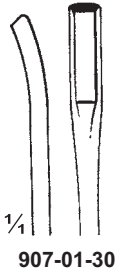

907-01-30

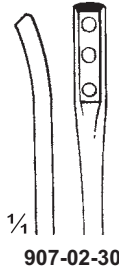

907-02-30

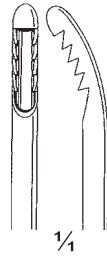

1/4



1/4

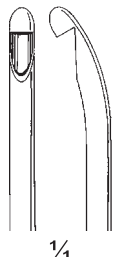

1/4



1/2

Kevorkian
907-01-30 TO 907-02-30
30 cm / 12"



1/4

907-06-27
27 cm / 10 1/2"
Malleable



1/2

Novak
907-03-23
23 cm / 9"
Ø 4 mm

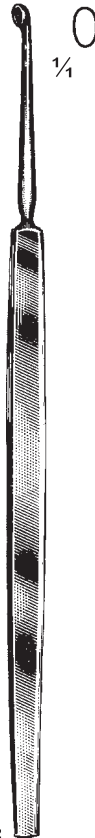

1/4

Reich-Nechtow
907-07-22
22 cm / 8 3/4"



1/2

Novak-Schoeckaert
907-04-24
24 cm / 9 1/2"



1/4

Asch
907-08-20
20 cm / 8"
Malleable



1/2

Randall
907-05-24
24 cm / 9 1/2"
Ø 4 mm

Biopsieküretten
Uterine Biopsy Curettes
Curettes pour biopsie



Biopsieküretten Uterine Biopsy Curettes Curettes pour biopsie

	1/4	1/4	1/4	1/4	1/4	1/4	1/4	1/4	1/4	1/4	1/4
Sharp	909-01-05	909-02-06	909-03-07	909-04-08	909-05-09	909-06-11	909-07-12	909-08-14	909-09-15	909-10-16	909-11-19
Blunt	909-19-05	909-20-06	909-21-07	909-22-08	909-23-09	909-24-11	909-25-12	909-26-14	909-27-15	909-28-16	909-29-19
Sharp	909-37-05	909-38-06	909-39-07	909-40-08	909-41-09	909-42-11	909-43-12	909-44-14	909-45-15	909-46-16	909-47-19
Blunt	909-55-05	909-56-06	909-57-07	909-58-08	909-59-09	909-60-11	909-61-12	909-62-14	909-63-15	909-64-16	909-65-19
	5 mm	6 mm	7 mm	8 mm	9 mm	11 mm	12 mm	14 mm	15 mm	16 mm	19 mm

1/4	1/4	1/4	1/4
Sharp 909-12-20	Sharp 909-13-21	Sharp 909-16-30	Sharp 909-18-40
Blunt 909-30-20	Blunt 909-31-21	Blunt 909-34-30	Blunt 909-36-40
Sharp 909-48-20	Sharp 909-49-21	Sharp 909-52-30	Sharp 909-54-40
Blunt 909-66-20	Blunt 909-67-21	Blunt 909-70-30	Blunt 909-72-40
20 mm	21 mm	30 mm	40 mm

1/4	1/4	1/2	1/2	1/4
Sharp 909-14-23	Sharp 909-15-25	Racamier 909-01-05 To 909-18-40	Racamier 909-37-05 To 909-54-40	Sharp 909-17-35
Blunt 909-32-23	Blunt 909-33-25	909-19-05 To 909-36-40	909-55-05 To 909-72-40	Blunt 909-35-35
Sharp 909-50-23	Sharp 909-51-25	31 cm / 12 1/2"	31 cm / 12 1/2"	Sharp 909-53-35
Blunt 909-68-23	Blunt 909-69-25			Blunt 909-71-35
23 mm	25 mm			35 mm

909-01-05 To 909-72-40
Also available in malleable

Biopsieküretten Uterine Biopsy Curettes Curettes pour biopsie



Biopsieküretten Uterine Biopsy Curettes Curettes pour biopsie

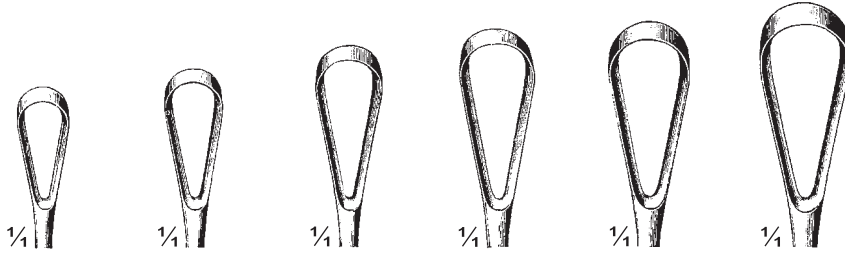
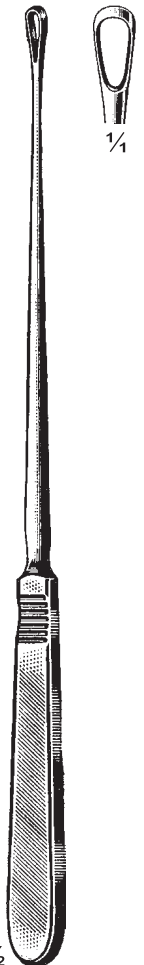

	Fig. 1	Fig. 2	Fig. 3	Fig. 4	Fig. 5	Fig. 6
Sharp	911-01-07	911-02-08	911-03-09	911-04-11	911-05-12	911-06-14
Blunt	911-07-07	911-08-08	911-09-09	911-10-11	911-11-12	911-12-14
Sharp	911-13-07	911-14-08	911-15-09	911-16-11	911-17-12	911-18-14
Blunt	911-19-07	911-20-08	911-21-09	911-22-11	911-23-12	911-24-14
Sharp	911-25-07	911-26-08	911-27-09	911-28-11	911-29-12	911-30-14
Blunt	911-31-07	911-32-08	911-33-09	911-34-11	911-35-12	911-36-14
	7 mm	8 mm	9 mm	11 mm	12 mm	14 mm



911-01-07 To 911-36-14
Also available in
malleable



Sims
911-01-07 To 911-06-14 Sharp
911-07-07 To 911-12-14 Blunt
26 cm / 10 1/4"

Sims
911-13-07 To 911-18-14 Sharp
911-19-07 To 911-24-14 Blunt
26 cm / 10 1/4"

Sims
911-25-07 To 911-30-14 Sharp
911-31-07 To 911-36-14 Blunt
26 cm / 10 1/4"

Sims (Herrera)
911-37-25 Sharp
25 cm / 10"

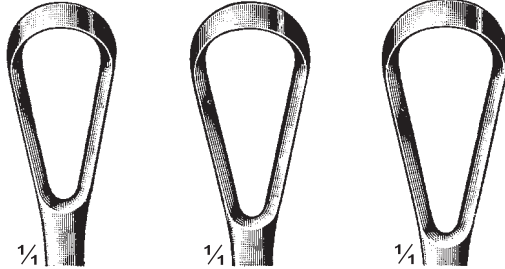

	Fig. 0	Fig. 1	Fig. 2
	912-01-10	912-02-11	912-03-13
Sharp	912-08-10	912-09-11	912-10-13
Blunt	912-15-10	912-16-11	912-17-13
Sharp	912-22-10	912-23-11	912-24-13
Blunt	10 mm	11 mm	13 mm

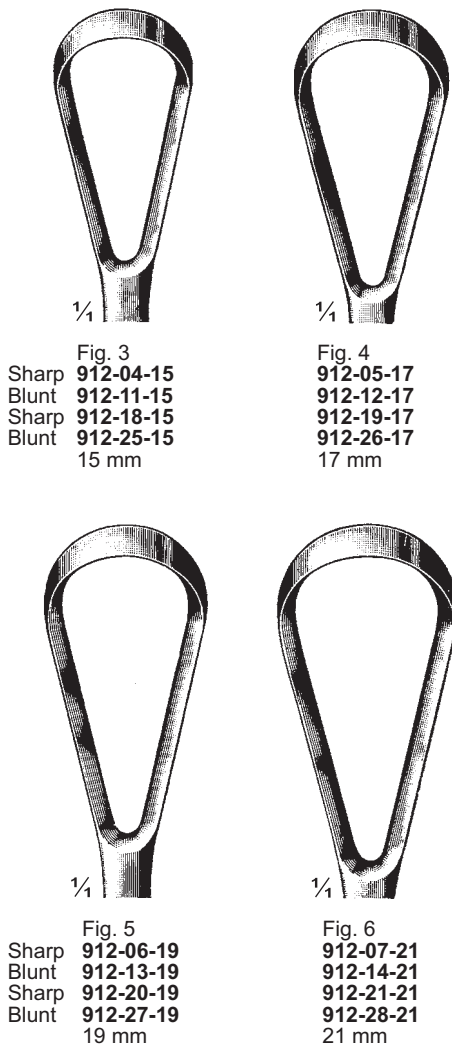
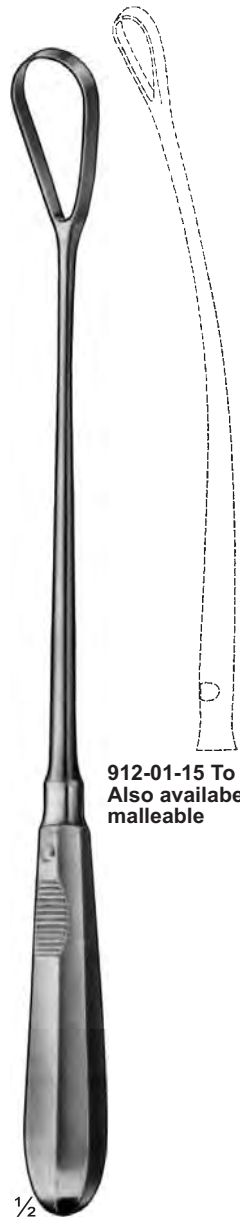
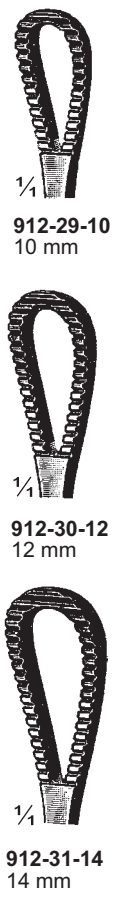

	Fig. 3	Fig. 4
	912-04-15	912-05-17
Sharp	912-11-15	912-12-17
Blunt	912-18-15	912-19-17
Sharp	912-25-15	912-26-17
Blunt	15 mm	17 mm

	Fig. 5	Fig. 6
	912-06-19	912-07-21
Sharp	912-13-19	912-14-21
Blunt	912-20-19	912-21-21
Sharp	912-27-19	912-28-21
Blunt	19 mm	21 mm



912-01-15 To 912-28-21
Also available in malleable



Bumm
912-01-15 To 912-07-21 Sharp
912-08-15 To 912-14-21 Blunt
29 cm / 11½"

Bumm
912-15-15 To 912-21-21 Sharp
912-22-15 To 912-28-21 Blunt
31 cm / 12¼"

Greene
912-29-10 To 912-31-14 Blunt
28 cm / 11"
Malleable

Biopsieküretten
Uterine Biopsy Curettes
Curettes pour biopsie

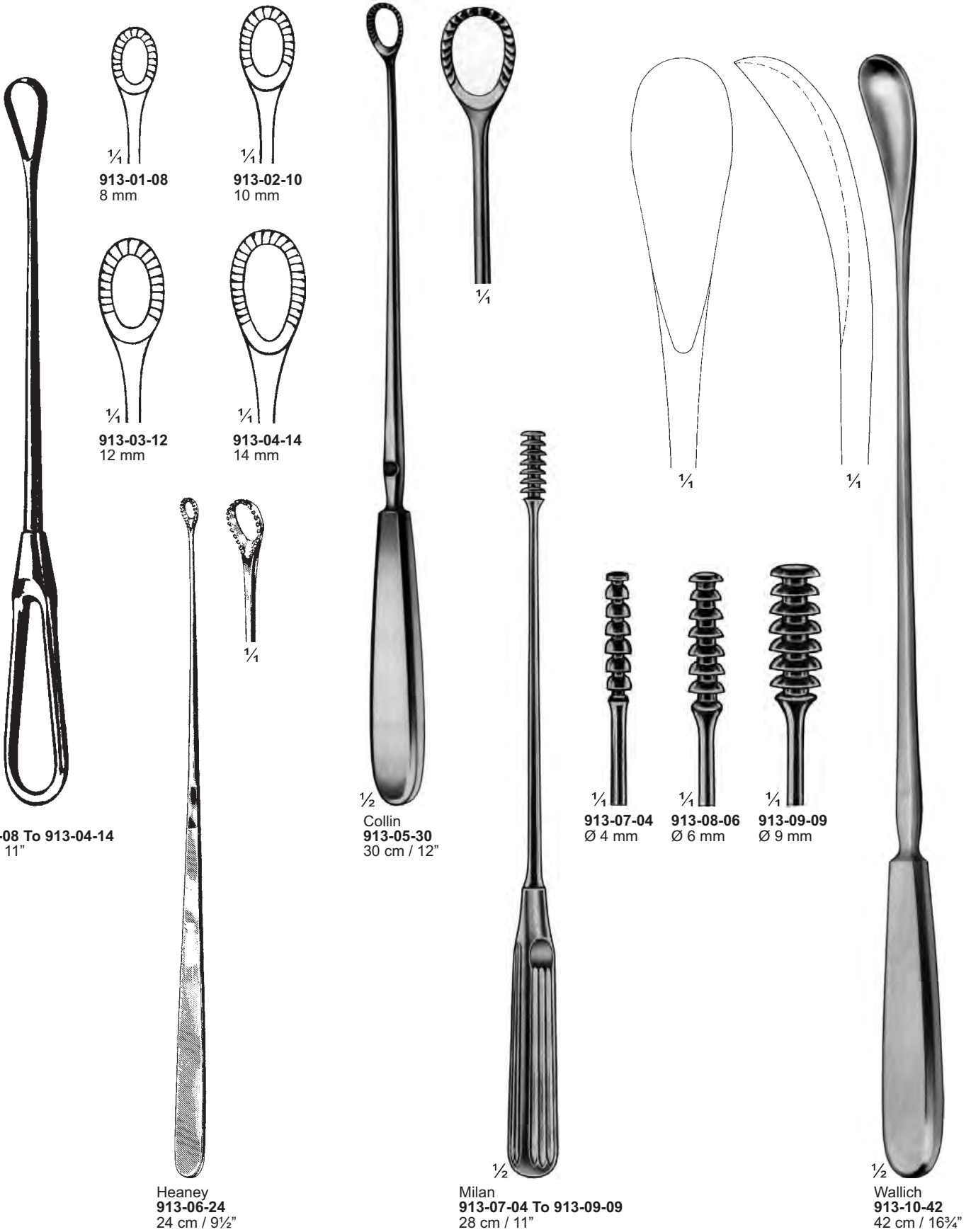

Collin
 913-01-08 To 913-04-14
 28 cm / 11"

Heaney
 913-06-24
 24 cm / 9½"

½
 Collin
 913-05-30
 30 cm / 12"

½
 Milan
 913-07-04 To 913-09-09
 28 cm / 11"

¼
 913-07-04
 Ø 4 mm

¼
 913-08-06
 Ø 6 mm

¼
 913-09-09
 Ø 9 mm

½
 Wallich
 913-10-42
 42 cm / 16¾"



1/2

Thomas
914-01-28 To 914-06-28
28 cm / 11"
Malleable, Blunt



1/4

914-01-28
914-07-28
914-13-28



1/4

914-02-28
914-08-28
914-14-28



1/4

914-03-28
914-09-28
914-15-28



1/4

914-04-28
914-10-28
914-16-28



1/4

914-05-28
914-11-28
914-17-28



1/4

914-06-28
914-12-28
914-18-28



1/4

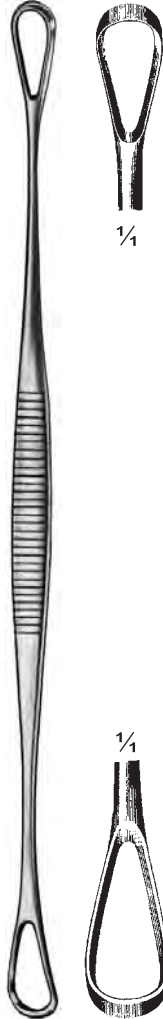

Blake
914-19-27
27 cm / 10 1/2"
Sh/Bl



1/4



1/2

Thomas
914-07-28 To 914-12-28
28 cm / 11"
Malleable, Blunt



1/4



1/4

Zaufel (Blake)
914-20-31
31 cm / 12 1/4"
Sh/Bl



1/4



Thomas
914-13-28 To 914-18-28
28 cm / 11"
Malleable, Blunt

**Biopsieküretten
Uterine Biopsy Curettes
Curettes pour biopsie**

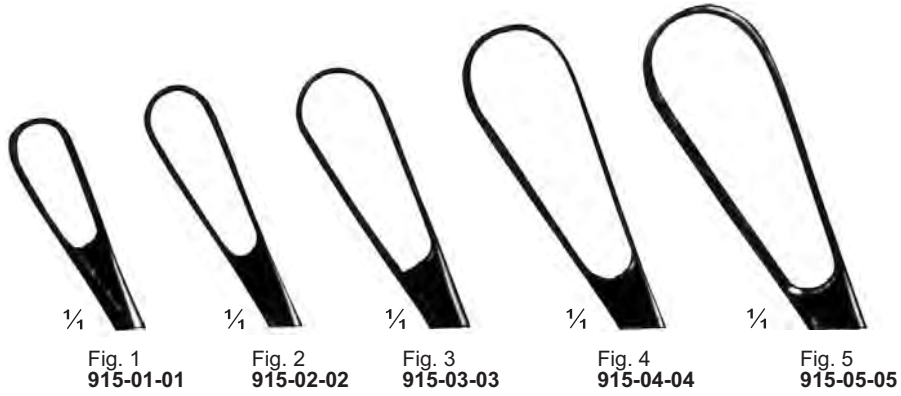

Sims
915-01-01 To 915-05-05
28 cm / 11"
Sharp
Malleable



J. O. M. W Type
915-06-04 To 915-11-15
28 cm / 11"

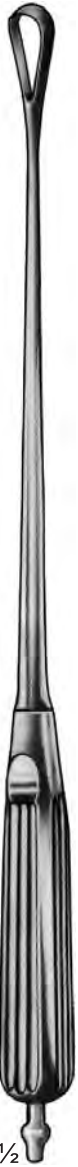

Recamier (Sims)
916-01-08 To 916-03-14
30 cm / 12"



Fig. 2
916-01-08
8 mm



Fig. 4
916-02-11
11 mm



Fig. 6
916-03-14
14 mm



1/2
916-04-08
8 mm



1/2
916-05-08
8 mm
Sharp



1/2
916-06-10
10 mm
Blunt



916-07-30
30 cm / 12"
Complete set consisting
1 Handle and 3 curettes



1/2
Hildebrandt
916-08-21
21 cm / 8 1/4"



1/2
Bozemann-Fritsch
916-09-08 Ø 8 mm
916-10-10 Ø 10 mm
35 cm / 14"



1/2
916-04-08 To 916-06-10
30 cm / 12"
With handle

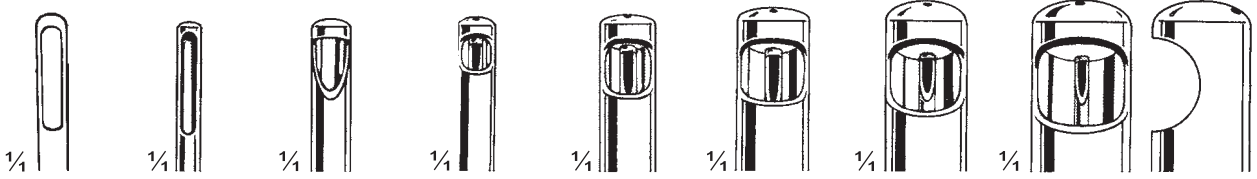

917-01-04
28 cm / 11"
Ø 4 mm

917-02-03
28 cm / 11"
Ø 3 mm

917-03-04
28 cm / 11"
Ø 4.5 mm

917-04-06
28 cm / 11"
Ø 6 mm

917-05-08
28 cm / 11"
Ø 8 mm

917-06-10
28 cm / 11"
Ø 10 mm

917-07-12
28 cm / 11"
Ø 12 mm

917-08-14
28 cm / 11"
Ø 14 mm

917-09-10
10 cm / 4"

**Uteruslöffel
Uterine Scoops
Curettes Utérines**

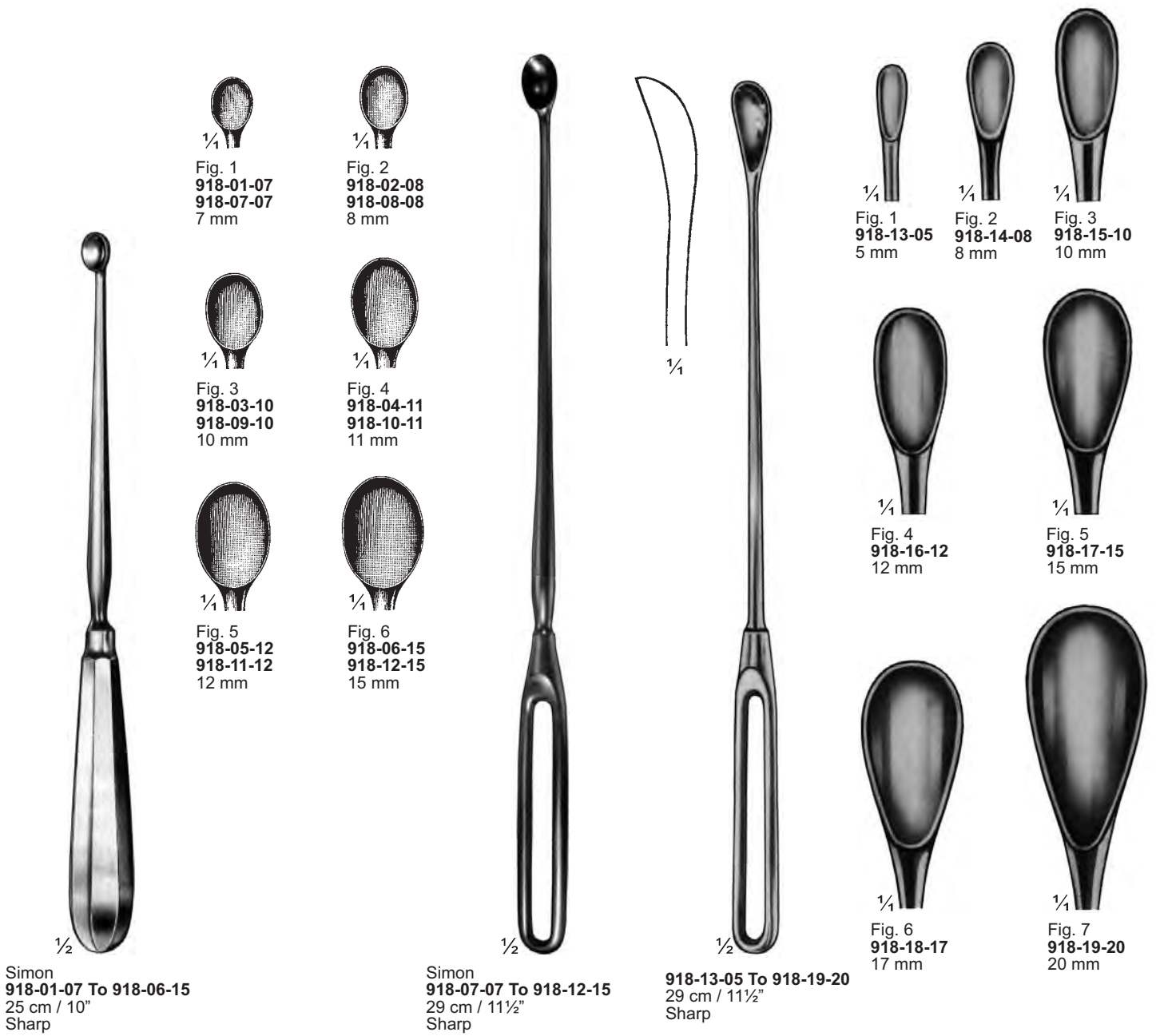

$\frac{1}{4}$
Fig. 1
918-01-07
918-07-07
7 mm

$\frac{1}{4}$
Fig. 2
918-02-08
918-08-08
8 mm

$\frac{1}{4}$
Fig. 1
918-13-05
5 mm

$\frac{1}{4}$
Fig. 2
918-14-08
8 mm

$\frac{1}{4}$
Fig. 3
918-15-10
10 mm

$\frac{1}{4}$
Fig. 3
918-03-10
918-09-10
10 mm

$\frac{1}{4}$
Fig. 4
918-04-11
918-10-11
11 mm

$\frac{1}{4}$
Fig. 4
918-16-12
12 mm

$\frac{1}{4}$
Fig. 5
918-17-15
15 mm

$\frac{1}{4}$
Fig. 5
918-05-12
918-11-12
12 mm

$\frac{1}{4}$
Fig. 6
918-06-15
918-12-15
15 mm

$\frac{1}{4}$
Fig. 6
918-18-17
17 mm

$\frac{1}{4}$
Fig. 7
918-19-20
20 mm

Simon
918-01-07 To 918-06-15
25 cm / 10"
Sharp

Simon
918-07-07 To 918-12-15
29 cm / 11½"
Sharp

918-13-05 To 918-19-20
29 cm / 11½"
Sharp

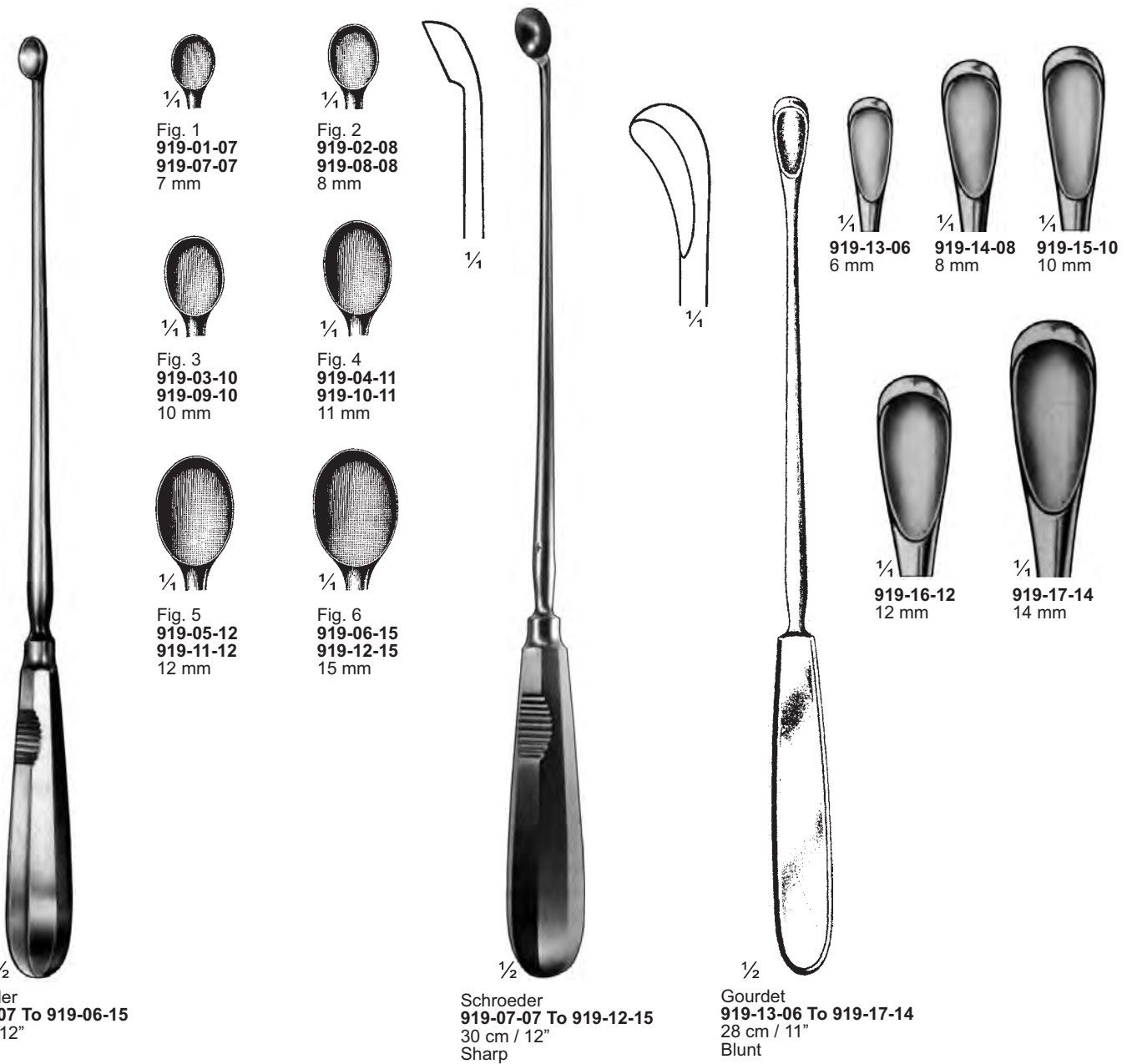

Schroeder
919-01-07 To 919-06-15
30 cm / 12"
Sharp

Schroeder
919-07-07 To 919-12-15
30 cm / 12"
Sharp

Gourdet
919-13-06 To 919-17-14
28 cm / 11"
Blunt

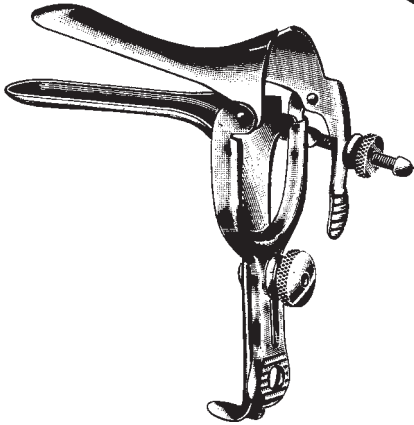

Grave
920-01-75
75 X 20 mm

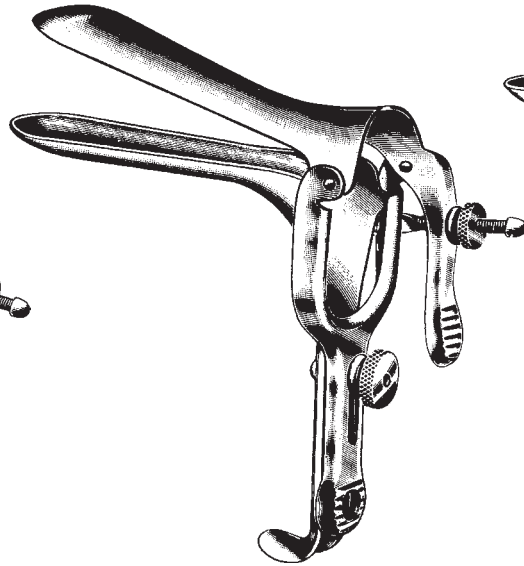

Grave
920-02-95
95 X 30 mm

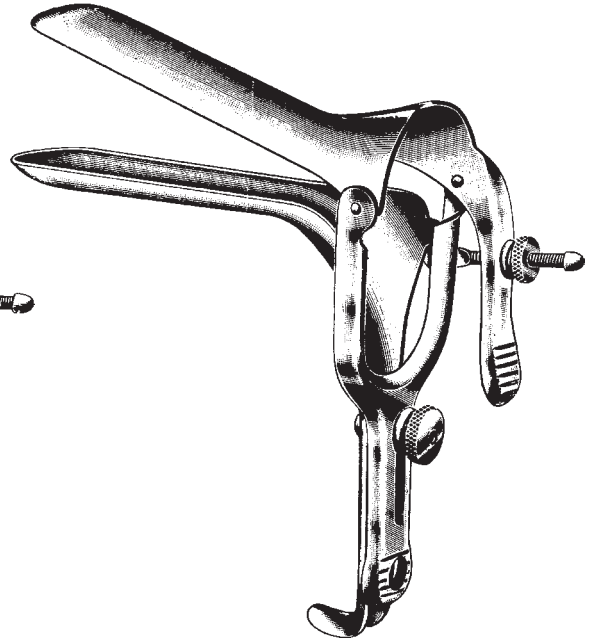

Grave
920-03-115
115 X 35 mm



Grave Modif.
920-04-45
115 X 35 mm
45°



Grave Modif.
920-05-90
115 X 35 mm
90°

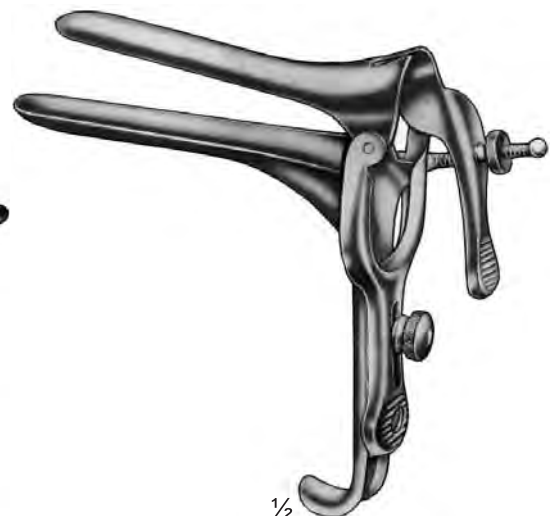

$\frac{1}{2}$
Pederson
920-06-75 75 X 13 mm
920-07-100 100 X 22 mm
920-08-120 120 X 25 mm

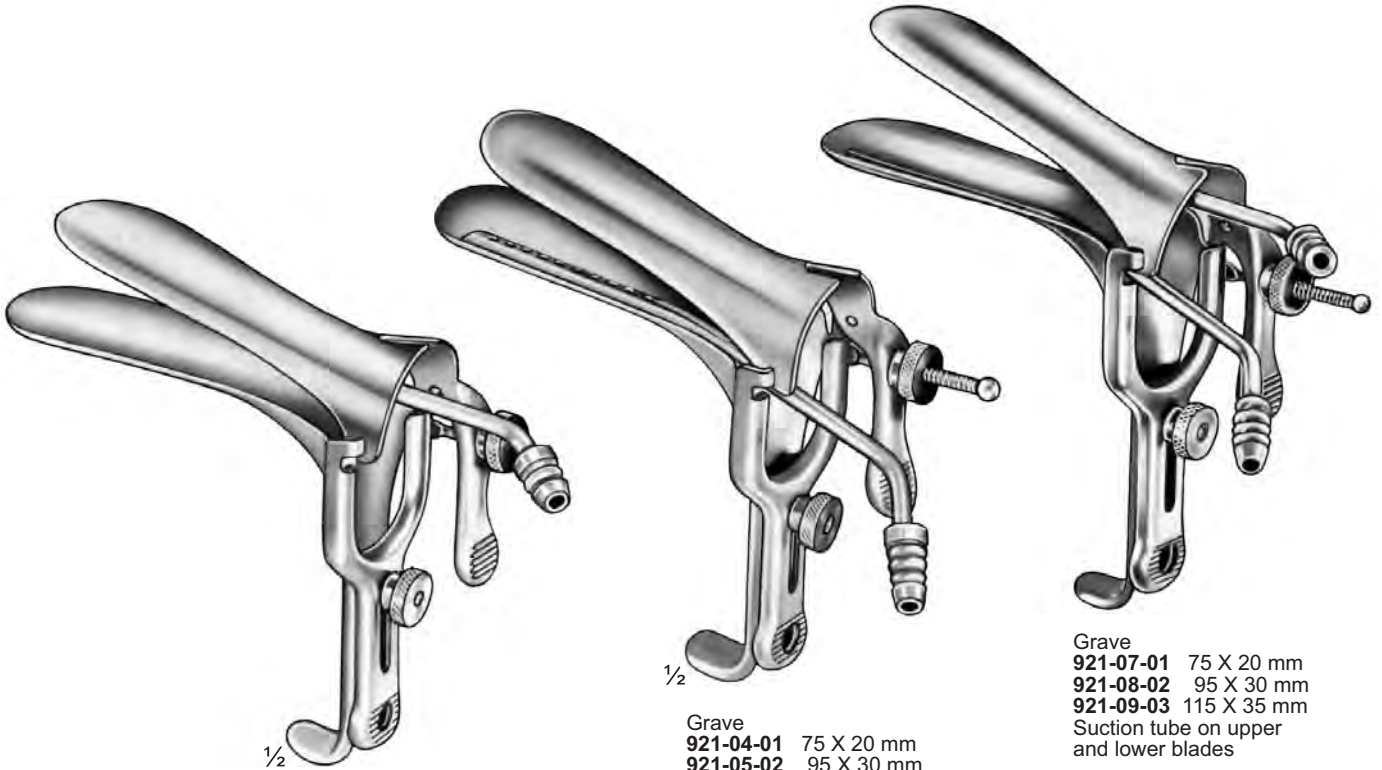

Grave
921-01-01 75 X 20 mm
921-02-02 95 X 30 mm
921-03-03 115 X 35 mm
Suction tube on upper blade

Grave
921-04-01 75 X 20 mm
921-05-02 95 X 30 mm
921-06-03 115 X 35 mm
Suction tube on lower blade

Grave
921-07-01 75 X 20 mm
921-08-02 95 X 30 mm
921-09-03 115 X 35 mm
Suction tube on upper and lower blades

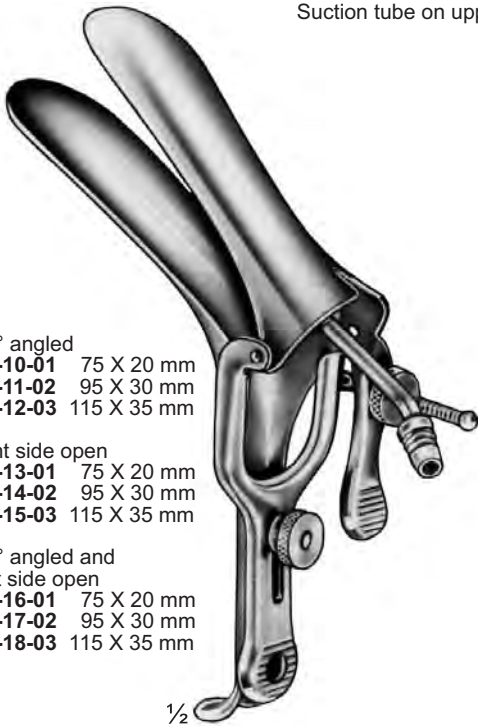

135° angled
921-10-01 75 X 20 mm
921-11-02 95 X 30 mm
921-12-03 115 X 35 mm

Right side open
921-13-01 75 X 20 mm
921-14-02 95 X 30 mm
921-15-03 115 X 35 mm

135° angled and right side open
921-16-01 75 X 20 mm
921-17-02 95 X 30 mm
921-18-03 115 X 35 mm

Grave Special
921-10-01 To 921-18-03
Suction tube on upper blade

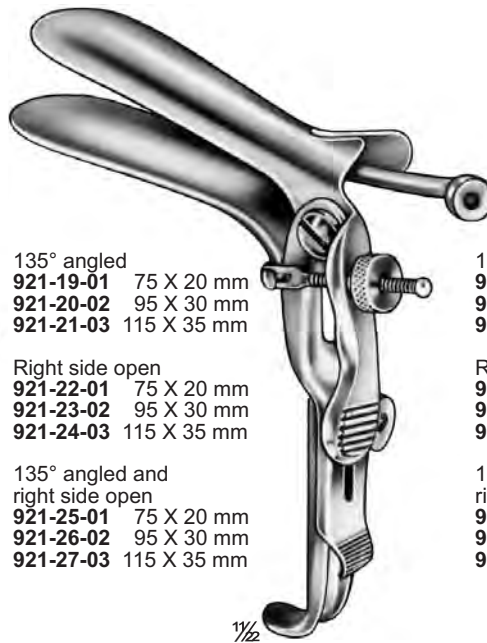

135° angled
921-19-01 75 X 20 mm
921-20-02 95 X 30 mm
921-21-03 115 X 35 mm

Right side open
921-22-01 75 X 20 mm
921-23-02 95 X 30 mm
921-24-03 115 X 35 mm

135° angled and right side open
921-25-01 75 X 20 mm
921-26-02 95 X 30 mm
921-27-03 115 X 35 mm

Grave Special
921-19-01 To 921-27-03
Suction tube on upper blade

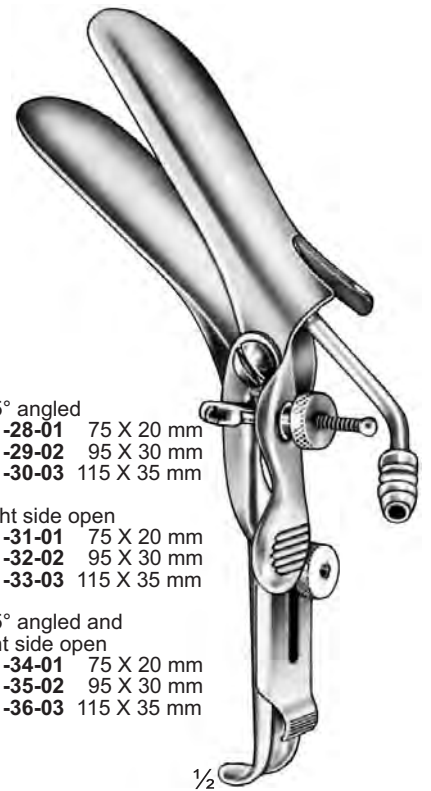

135° angled
921-28-01 75 X 20 mm
921-29-02 95 X 30 mm
921-30-03 115 X 35 mm

Right side open
921-31-01 75 X 20 mm
921-32-02 95 X 30 mm
921-33-03 115 X 35 mm

135° angled and right side open
921-34-01 75 X 20 mm
921-35-02 95 X 30 mm
921-36-03 115 X 35 mm

Grave Special
921-28-01 To 921-36-03
Suction tube on upper and lower blades

Vaginalspekula
Vaginal Specula
Spéculum vaginaux

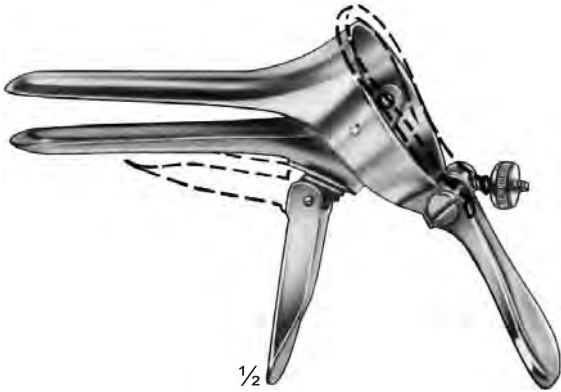

1/2

Cusco
922-01-00
75 X 17 mm
Virgin



1/2

Cusco
922-02-01 75 X 32 mm
922-03-02 85 X 35 mm
922-04-03 100 X 35 mm



1/2

Cusco
922-05-01 80 X 22 mm
922-06-02 100 X 25 mm
922-07-03 105 X 27 mm
Swiss model

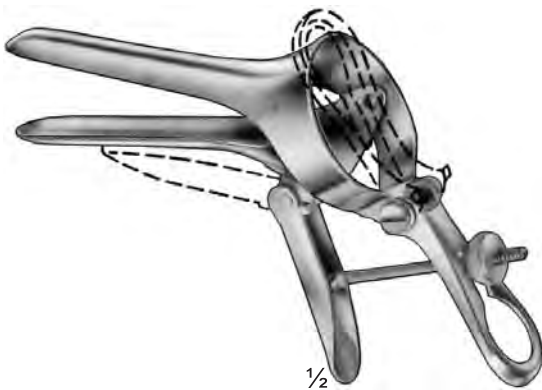

1/2

Cusco
922-08-00
75 X 17 mm
Virgin



1/2

Cusco
922-09-01 75 X 32 mm
922-10-02 85 X 35 mm
922-11-03 100 X 35 mm



1/2

Cusco
922-12-01 80 X 22 mm
922-13-02 90 X 37 mm
922-14-03 115 X 37 mm
Flat duck beak

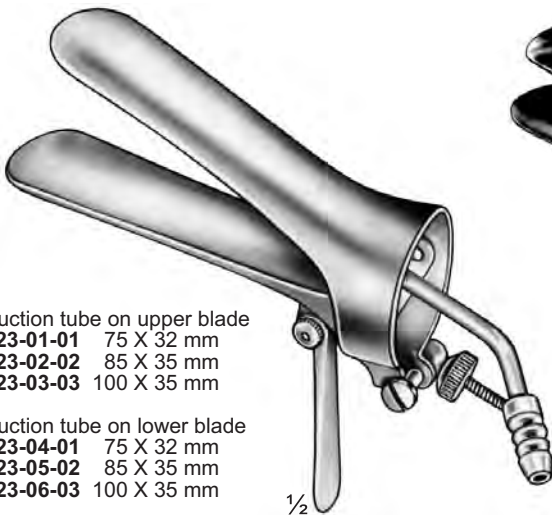

Suction tube on upper blade
923-01-01 75 X 32 mm
923-02-02 85 X 35 mm
923-03-03 100 X 35 mm

Suction tube on lower blade
923-04-01 75 X 32 mm
923-05-02 85 X 35 mm
923-06-03 100 X 35 mm

Suction tube on both blade
923-07-01 75 X 32 mm
923-08-02 85 X 35 mm
923-09-03 100 X 35 mm

Cusco
923-01-01 To 923-09-03



Cusco
923-10-01 75 X 32 mm
923-11-02 85 X 35 mm
923-12-03 100 X 35 mm
 Cromium plated in
 black colour



Cusco
923-13-01 80 X 22 mm
923-14-02 100 X 25 mm
923-15-03 105 X 27 mm
 Cromium plated in
 black colour



Cusco (Japanese Model)
923-16-01 Small
923-17-02 Medium
923-18-03 Large

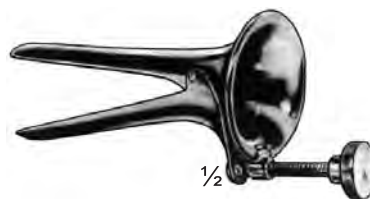

Collin
923-19-00
 55 X 10 mm
 For children

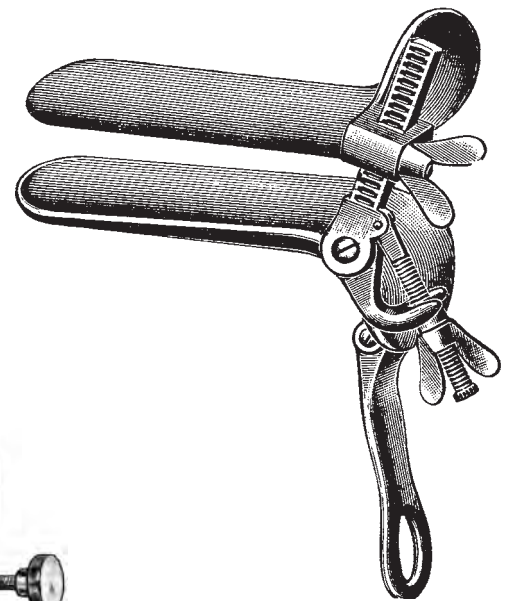

Trelat
923-20-01 85 X 33 mm
923-21-02 95 X 35 mm
923-23-03 115 X 43 mm



Collin
924-01-00
65 X 20 mm
Virgin



Collin
924-02-01 85 X 30 mm Small
924-03-02 100 X 35 mm Medium
924-04-03 110 X 40 mm Large



Collin (New Model)
924-03-02
100 X 35 mm
Medium



Collin (New Model)
924-04-03
110 X 40 mm
Large



Collin (New Model)
924-05-00 65 X 20 mm Virgin
924-06-01 85 X 30 mm Small
924-07-02 100 X 35 mm Medium
924-08-03 110 X 40 mm Large
Cromium plated in
black colour

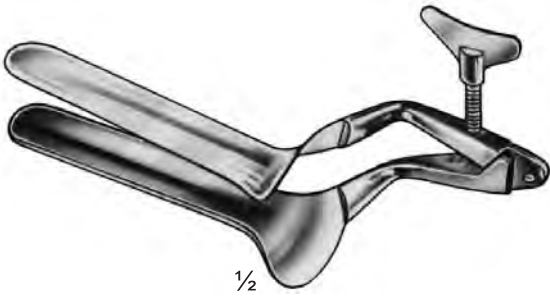

Collin
925-01-01 65 X 20 mm
925-02-02 90 X 16 mm

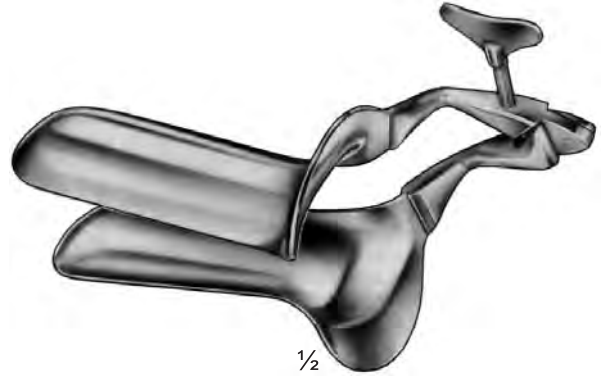

Collin
925-03-01 85 X 30 mm
925-04-02 100 X 35 mm
925-05-03 110 X 40 mm



Collin-Landau
925-06-01 90 X 30 mm
925-07-02 100 X 35 mm



Seyffert
925-08-100 100 X 17 mm
925-09-110 110 X 33 mm
23 cm / 9"

Seyffert
925-10-110 110 X 33 mm
23 cm / 9"
One side open for taking
instruments and catheters



Semm
926-01-01 90 X 14 mm
926-02-02 100 X 17 mm
926-03-03 100 X 25 mm

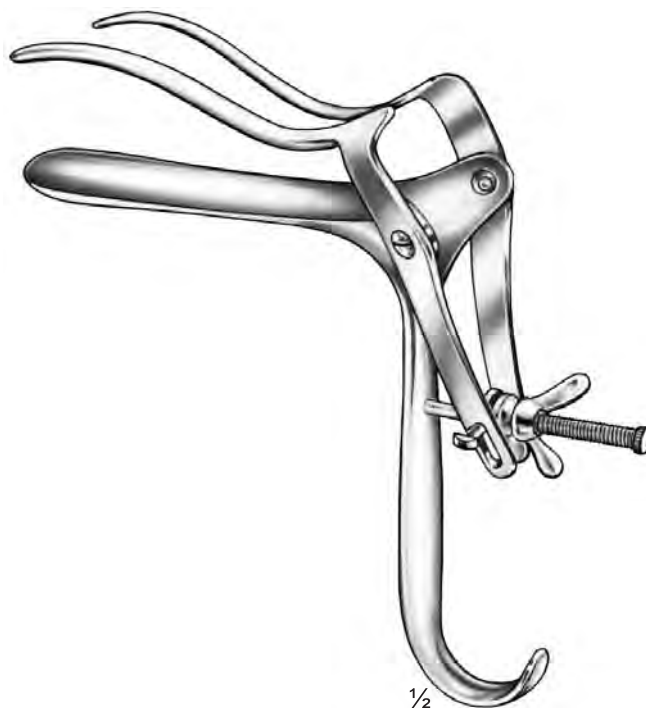

Nott
926-04-01 80 X 30 mm
926-05-02 110 X 30 mm



Guttman
926-06-90
90 X 35 mm



Guttman
926-07-80
80 X 45 mm

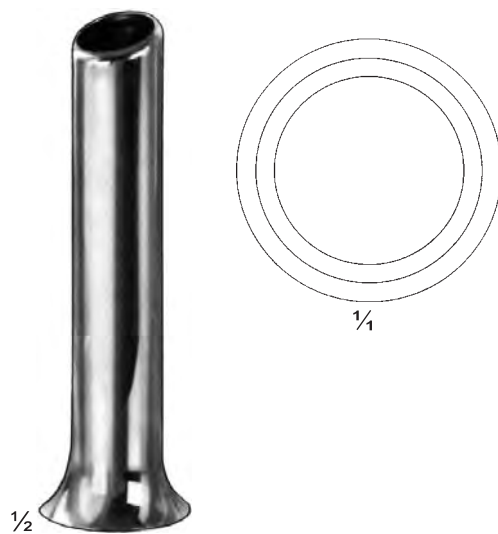

Fergusson
926-08-25 Ø 25 mm
926-09-30 Ø 30 mm
926-10-35 Ø 35 mm



1/2

Auvard
927-01-75 75 X 42 mm
927-02-105 105 X 43 mm
23 cm / 9"
1.470 kg
With detachable weight



1/2

Auvard
927-03-65 65 X 38 mm
23 cm / 9"
1.530 kg
With fixed weight



1/2

Auvard
927-04-80 80 X 38 mm
21 cm / 8 1/4"
With detachable weight

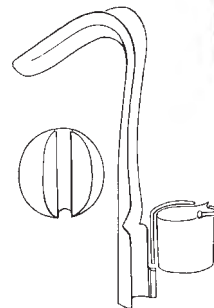

1/2

Samuel
927-05-85 85 X 36 mm
21 cm / 8 1/4"
With detachable weight and
metal strainer with perforated bottom

Vaginalspekula
Vaginal Specula
Spéculum vaginaux



1/2

Weissbarth
928-01-80 80 X 28 mm
928-02-85 85 X 42 mm
21 cm / 8 1/4"



1/3

928-03-35
35 X 54 mm



1/3

928-04-39
39 X 60 mm



1/3

928-05-42
42 X 65 mm

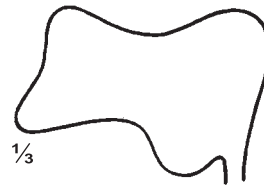

1/3

928-06-48
48 X 68 mm



1/2

928-03-35 To 928-06-48
27 cm / 10 1/2"



1/2

Soonawala
928-07-01



1/2

Soonawala
928-08-02



929-01-80
80 X 30 mm



929-02-85
85 X 35 mm



929-03-85
85 X 40 mm

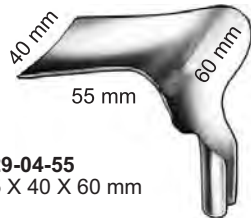

929-04-55
55 X 40 X 60 mm

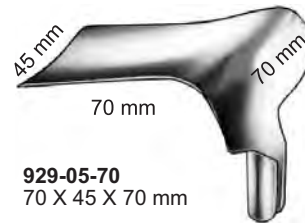

929-05-70
70 X 45 X 70 mm



Scherback
929-06-19
19 cm / 7½"
929-07-05
Complete with 5 blades
(929-01-80 To 929-05-80)



Scherback
929-08-19
19 cm / 7½"
929-09-05
Complete with 5 blades
(929-01-80 To 929-05-70)



Scherback
929-10-18
18 cm / 7"
929-11-05
Complete with 5 blades
(929-01-80 To 929-05-70)



Scherback
929-12-800
800 grs



Scherback
929-13-400 400 grs
929-14-800 800 grs

Vaginalspekula
Vaginal Specula
Spéculum vaginaux



930-01-80
80 X 30 mm



930-02-85
85 X 33 mm



930-03-100
100 X 38 mm



930-04-110
110 X 42 mm



930-05-65
65 X 30 mm



930-06-75
75 X 35 mm



930-07-85
85 X 35 mm



930-08-95
95 X 35 mm



Bozemann
930-09-23
23 cm / 9"
930-10-08
Complete with 8 blades
(930-01-80 To 930-08-95)

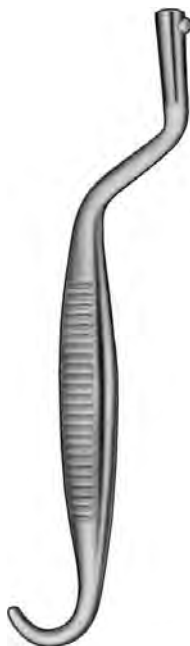

Bozemann
930-11-22
22 cm / 8³/₄"
930-12-08
Complete with 8 blades
(930-01-80 To 930-08-95)



Bozemann
930-13-23
23 cm / 9"
930-14-08
Complete with 8 blades
(930-01-80 To 930-08-95)



Bozemann
930-15-22
22 cm / 8³/₄"
930-16-08
Complete with 8 blades
(930-01 To 930-08)



Sims
931-01-01 65 X 25 mm
 70 X 20 mm
931-02-02 70 X 30 mm
 70 X 35 mm
931-03-03 85 X 35 mm
 90 X 40 mm



Eastman
931-04-01 75 X 38 mm
931-05-02 90 X 38 mm
931-06-03 100 X 38 mm



Breisky
931-07-01 72 X 25 mm
 77 X 30 mm
931-08-02 75 X 30 mm
 92 X 38 mm

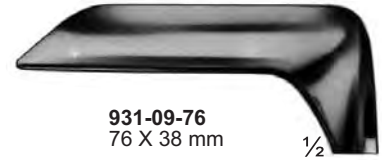

931-09-76
76 X 38 mm



931-10-89
89 X 38 mm



931-11-102
102 X 38 mm



Jackson
931-09-89 To 931-11-102
18 cm / 7"

Vaginalspekula
Vaginal Specula
Spéculum vaginaux



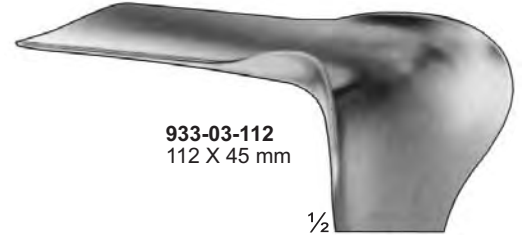
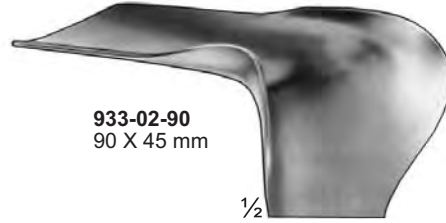
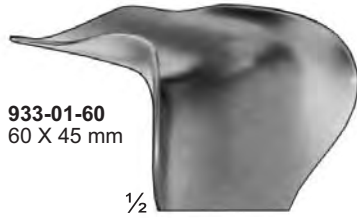

Doyen
933-01-60 To 933-03-112
23.5 cm / 9 1/4"

- 933-04-60 60 X 35 mm
- 933-05-90 90 X 35 mm
- 933-06-120 120 X 35 mm
- 933-07-60 60 X 45 mm
- 933-08-90 90 X 45 mm
- 933-09-120 120 X 45 mm
- 933-10-160 160 X 45 mm
- 933-11-60 60 X 60 mm
- 933-12-90 90 X 60 mm
- 933-13-120 120 X 60 mm
- 933-14-160 160 X 60 mm



Doyen
933-04-60 To 933-14-160
24 cm / 9 1/2"



Doyen
933-15-23
23 cm / 9"
Lateral speculum



Doyen
933-16-25
25 cm / 10"
Lateral speculum

- 934-01-100 100 X 20 mm
- 934-02-100 100 X 25 mm
- 934-03-100 100 X 30 mm
- 934-04-100 100 X 35 mm
- 934-05-130 130 X 40 mm
30 cm / 12"
- 934-06-130 130 X 20 mm
- 934-07-130 130 X 25 mm
- 934-08-130 130 X 30 mm
- 934-09-130 130 X 35 mm
- 934-10-130 130 X 40 mm
32 cm / 12³/₄"
- 934-11-160 160 X 40 mm
- 934-12-180 180 X 40 mm
35 cm / 14"



$\frac{1}{2}$
Breisky
(Wiener Model/Vienna Pattern)
934-01-100 To 934-12-180
32 cm / 12³/₄"



$\frac{1}{2}$
Landau
934-13-100 100 X 28 mm
934-14-110 110 X 28 mm
29 cm / 11¹/₂"

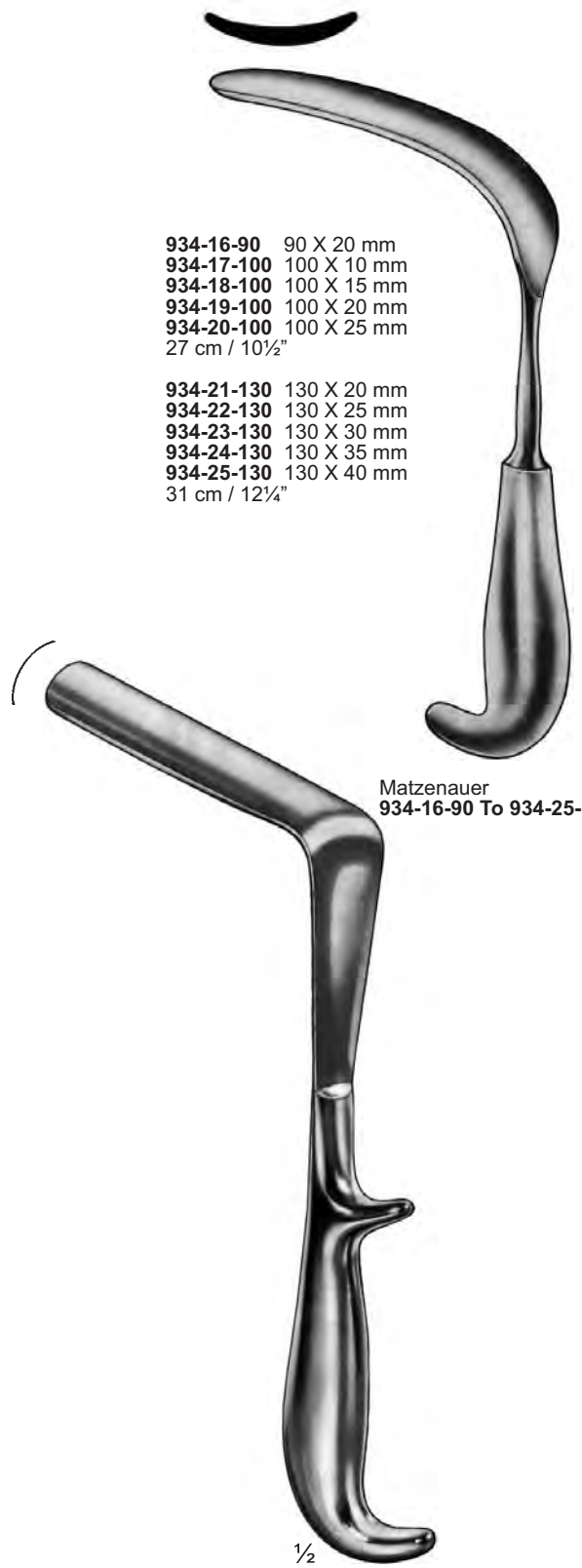

- 934-16-90 90 X 20 mm
- 934-17-100 100 X 10 mm
- 934-18-100 100 X 15 mm
- 934-19-100 100 X 20 mm
- 934-20-100 100 X 25 mm
27 cm / 10¹/₂"
- 934-21-130 130 X 20 mm
- 934-22-130 130 X 25 mm
- 934-23-130 130 X 30 mm
- 934-24-130 130 X 35 mm
- 934-25-130 130 X 40 mm
31 cm / 12¹/₄"

Matzenauer
934-16-90 To 934-25-130

$\frac{1}{2}$
Dunkel
934-15-25
25 cm / 10"

Vaginalspekula
Vaginal Specula
Spéculum vaginaux



935-01-70
 18 cm / 7"
 70 X 15 mm

1/2



935-05-75
 18 cm / 7"
 75 X 10 mm

1/2

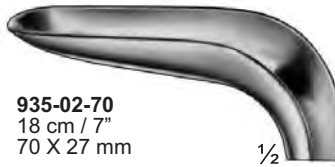

935-02-70
 18 cm / 7"
 70 X 27 mm

1/2



935-06-75
 18 cm / 7"
 75 X 23 mm

1/2

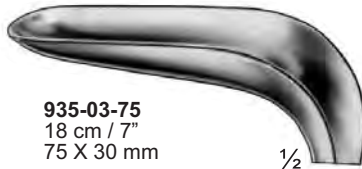

935-03-75
 18 cm / 7"
 75 X 30 mm

1/2



935-07-80
 18 cm / 7"
 80 X 25 mm

1/2

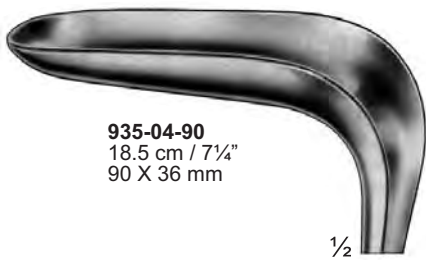

935-04-90
 18.5 cm / 7 1/4"
 90 X 36 mm

1/2

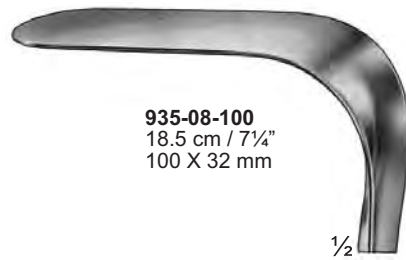

935-08-100
 18.5 cm / 7 1/4"
 100 X 32 mm

1/2



Kristeller
935-01-70 To 935-04-90
 Speculum



Kristeller
935-05-75 To 935-08-100
 Retractor



Kristeller
935-09-02 To 935-12-02
 Set of 2 pcs consisting
 1 Speculum and 1 Retractor

935-09-02 (935-01-70 TO 935-05-75)
935-10-02 (935-02-70 TO 935-06-75)
935-11-02 (935-03-90 TO 935-07-80)
935-12-02 (935-04-90 TO 935-08-100)



**Vaginalspekula
Vaginal Specula
Spéculum vaginaux**



937-01-110
21.5 cm / 8½"
110 X 27 mm

½

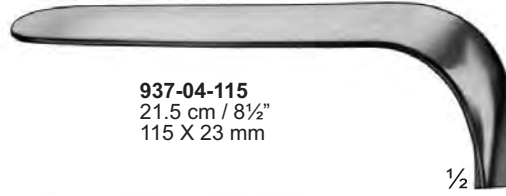

937-04-115
21.5 cm / 8½"
115 X 23 mm

½



937-02-110
22 cm / 8¾"
110 X 30 mm

½



937-05-115
22 cm / 8¾"
115 X 28 mm

½



937-03-110
23 cm / 9"
110 X 36 mm

½



937-06-120
23 cm / 9"
120 X 30 mm

½



½

Kristeller
937-01-110 To 937-03-110
Speculum



½

Kristeller
937-04-115 To 937-06-120
Retractor



½

937-07-02 (937-01-110 & 936-04-115)
937-08-02 (936-02-110 & 936-05-115)
937-09-02 (936-03-110 & 936-06-120)

Kristeller
937-07-02 To 937-09-02
Set of 2 pcs consisting
1 Speculum and 1 Retractor



1/2

938-01-01 105 X 26 mm
938-02-02 105 X 28 mm
938-03-03 105 X 33 mm
Specula



1/2

Kristeller
938-04-01 115 X 22 mm
938-05-02 115 X 24 mm
938-06-03 115 X 29 mm
Retractors



1/2

Kristeller
938-07-02 To 938-09-02
Set of 2 pcs consisting
1 Speculum and 1 Retractor

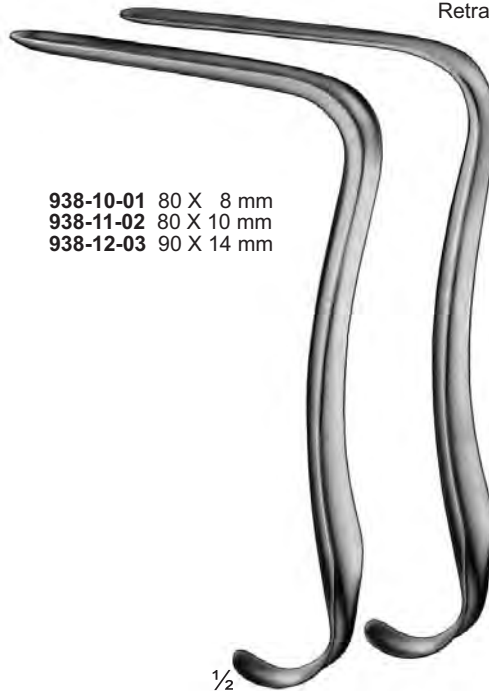

1/2

938-10-01 80 X 8 mm
938-11-02 80 X 10 mm
938-12-03 90 X 14 mm

Seidl
938-10-01 To 938-12-03
For children and infants





Landon
940-01-88
22 cm / 8³/₄"
88 X 25 mm



¹/₂
940-02-01 100 X 11 mm
100 X 20 mm
940-03-02 100 X 14 mm
100 X 26 mm



Kallmorgen
940-04-75
17 cm / 6³/₄"
75 X 39 mm

Kallmorgen
940-05-75
17 cm / 6³/₄"
75 X 33 mm
940-06-02 Set of 2 pcs
(940-04-75 TO 940-05-75)



Kallmorgen
940-07-95
20 cm / 8"
95 X 39 mm

Kallmorgen
940-08-95
20 cm / 8"
95 X 33 mm
940-09-2 Set of 2 pcs
(940-07-95 TO 940-08-95)

Vaginalspekula
Vaginal Specula
Spéculum vaginaux

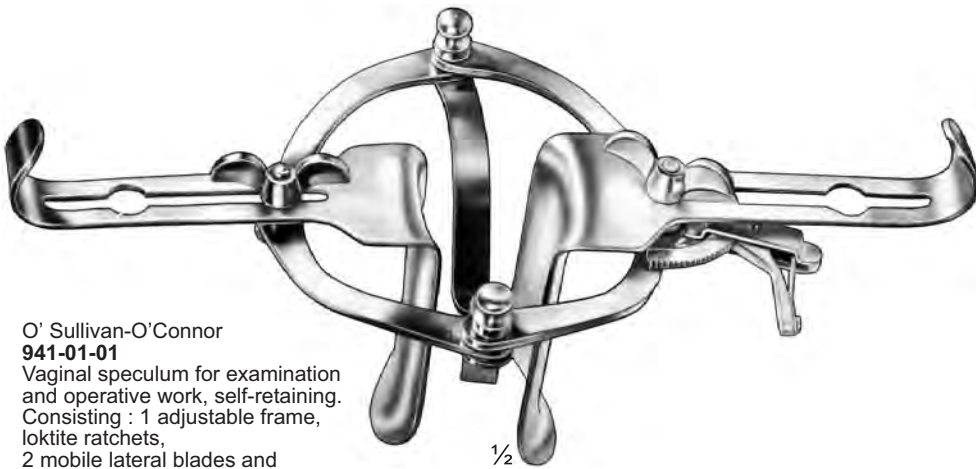

O' Sullivan-O'Connor
941-01-01
Vaginal speculum for examination and operative work, self-retaining. Consisting : 1 adjustable frame, loktite ratchets, 2 mobile lateral blades and 3 interchangeable blades 941-02-45 To 941-04-90

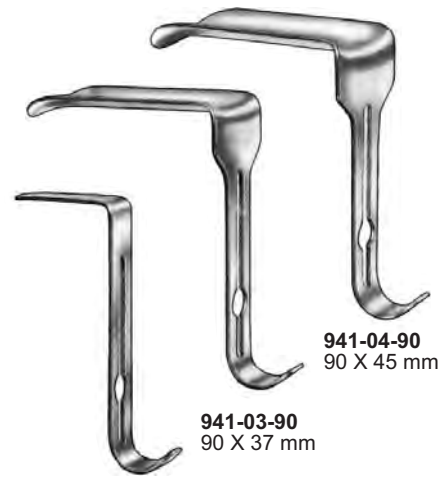

941-02-45
45 X 17 mm

941-03-90
90 X 37 mm

941-04-90
90 X 45 mm

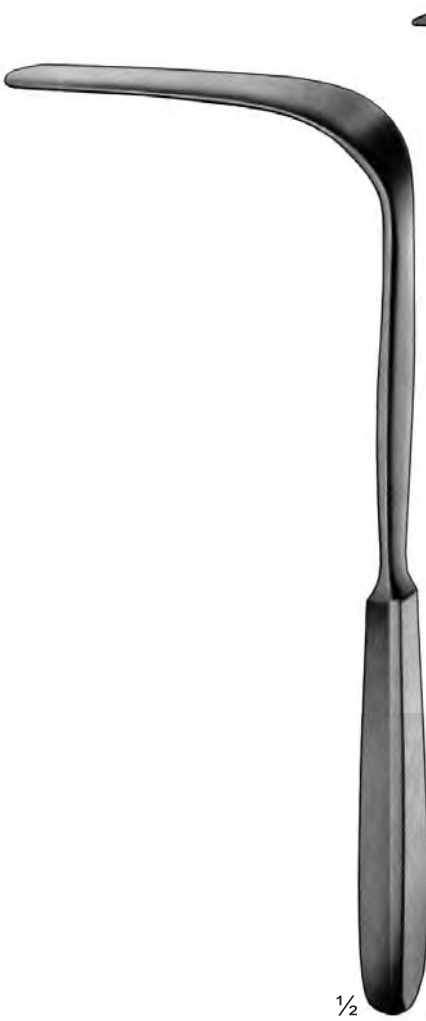

$\frac{1}{2}$
941-05-25
25 cm / 10"

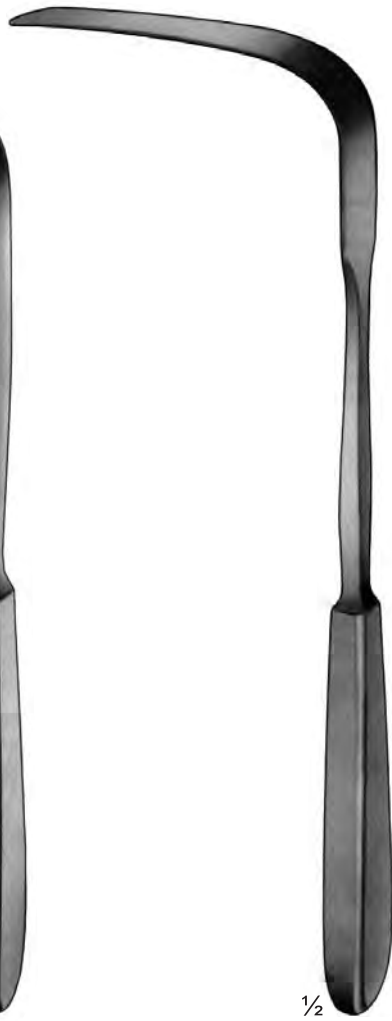

$\frac{1}{2}$
Tubinger Model
941-06-26
26.5 cm / 10 $\frac{1}{2}$ "



941-07-115
115 X 22 mm

941-08-115
115 X 26 mm

$\frac{1}{2}$

$\frac{1}{2}$
Simon
941-07-115 TO 941-08-115
27.5 cm / 10 $\frac{3}{4}$ "

Vaginalspekula
Vaginal Specula
Spéculum vaginaux

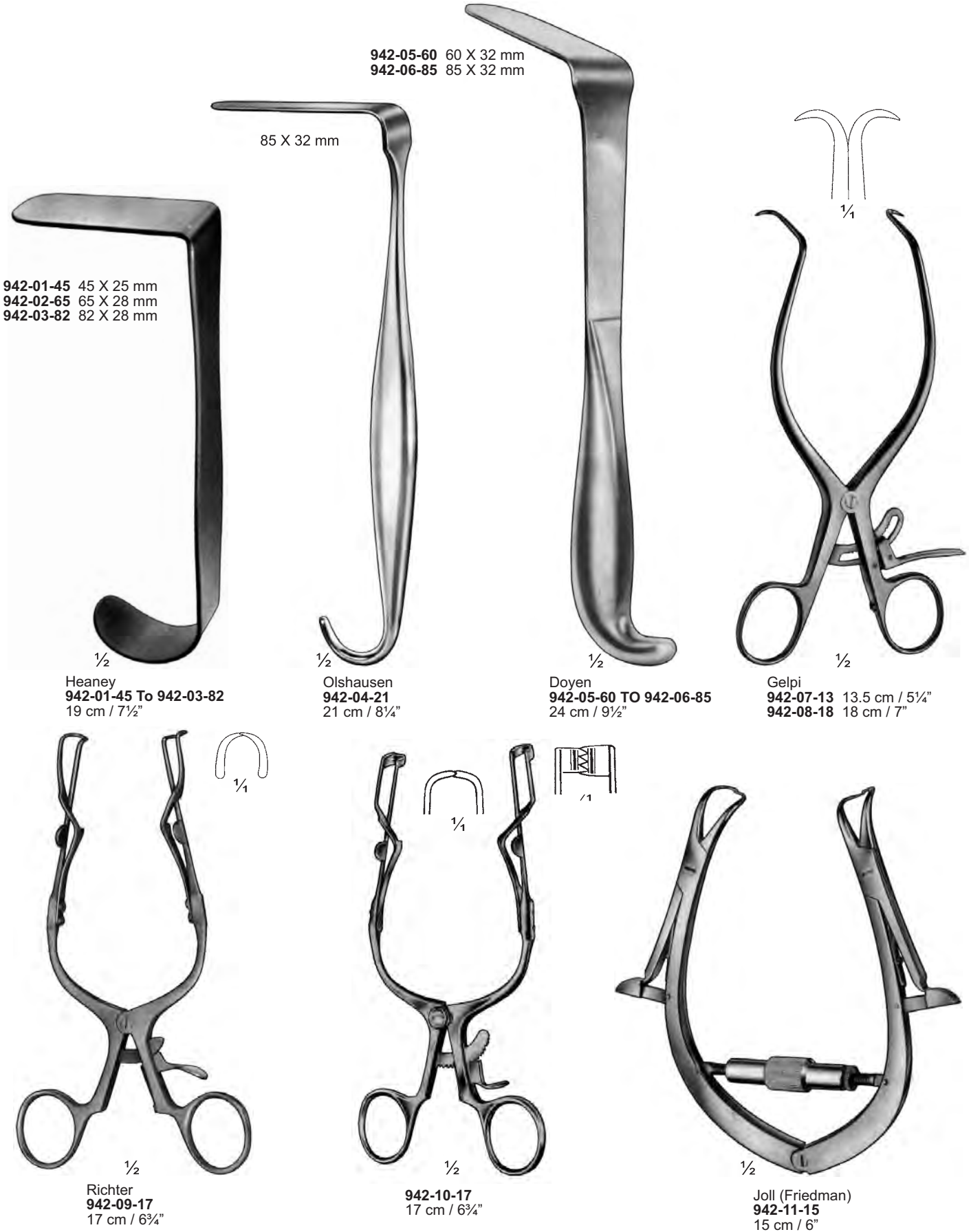

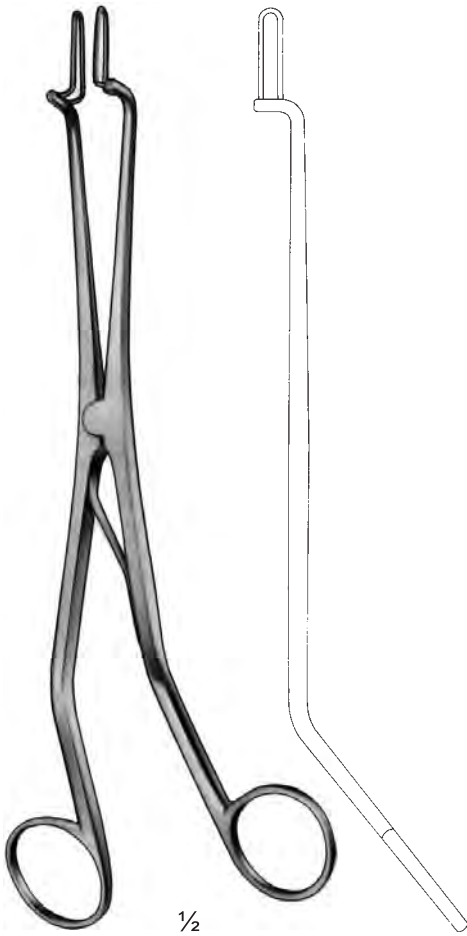
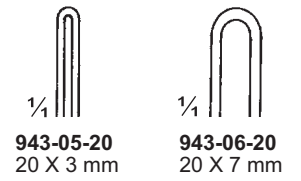
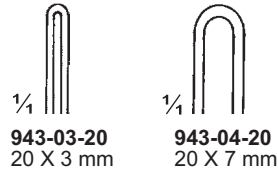
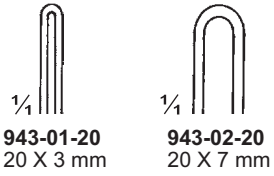

Kogan
943-01-20 TO 943-02-20
24 cm / 9 1/2"
Endospecula for cervix
and urethra, without ratchet



Kogan
943-03-20 TO 943-04-20
24 cm / 9 1/2"
Endospecula for cervix
and urethra, with scale-ratchet
and fixing screws



Kogan
943-05-20 TO 943-06-20
28 cm / 11"
Endospecula for cervix
and urethra, with ratchet

Abortuszangen
Placenta and Ovum Forceps
Pinces placentaires et pour poste-abortum

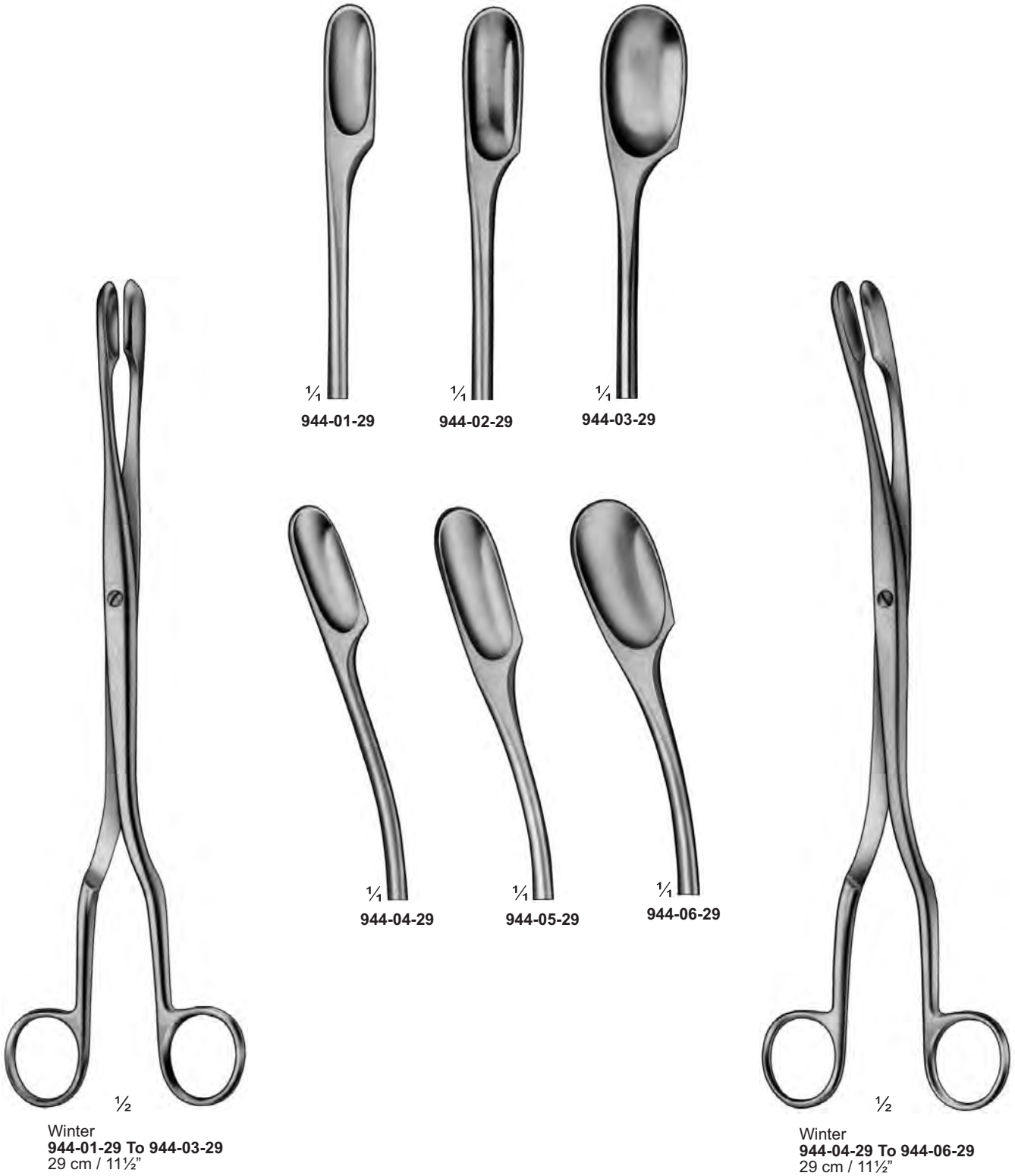

Abortuszangen
Placenta and Ovum Forceps
Pinces placentaires et pour poste-abortum



Winter
945-01-29 To 945-03-29
29 cm / 11½"

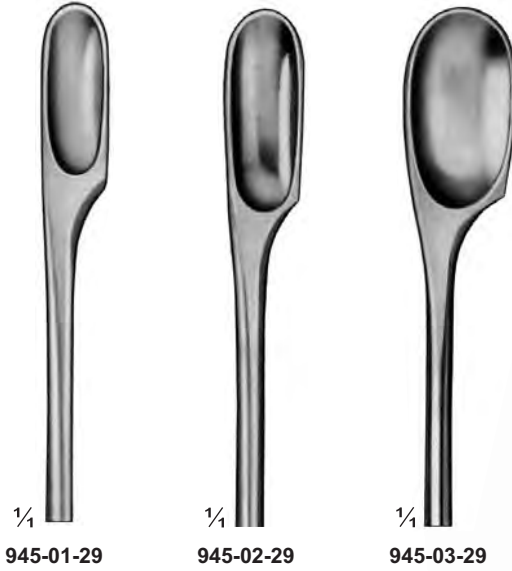

¼
945-01-29

¼
945-02-29

¼
945-03-29

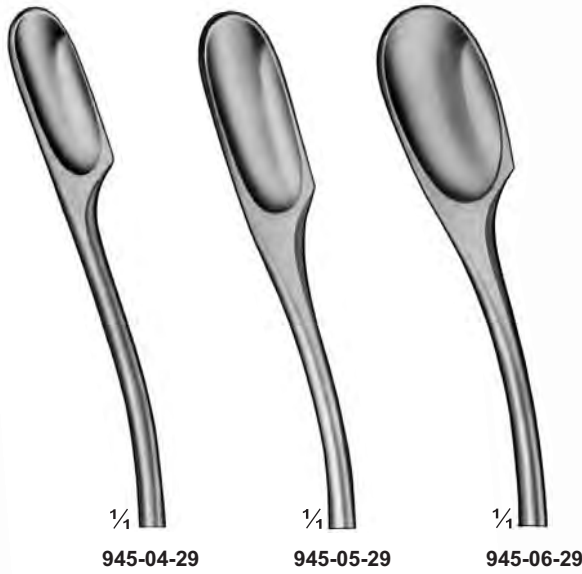

¼
945-04-29

¼
945-05-29

¼
945-06-29



Winter
945-04-29 To 945-06-29
29 cm / 11½"

Abortuszangen
Placenta and Ovum Forceps
Pinces placentaires et pour poste-abortum

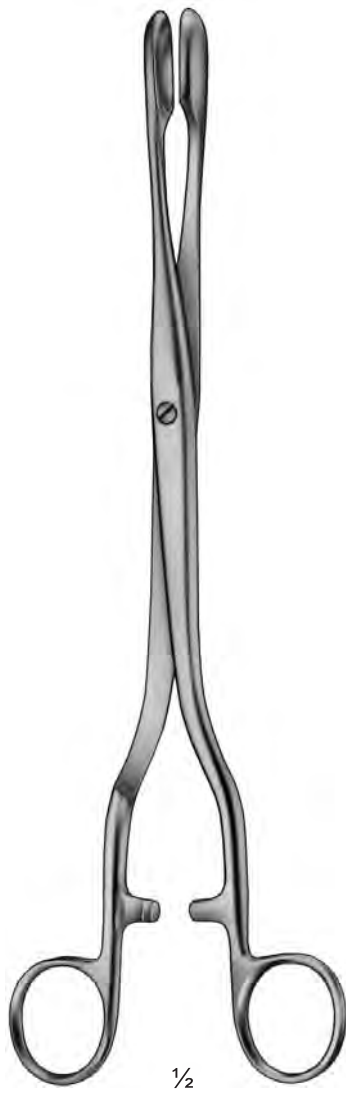
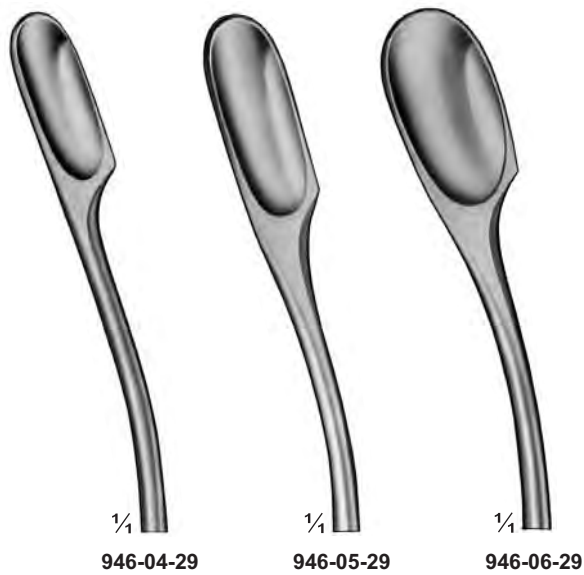
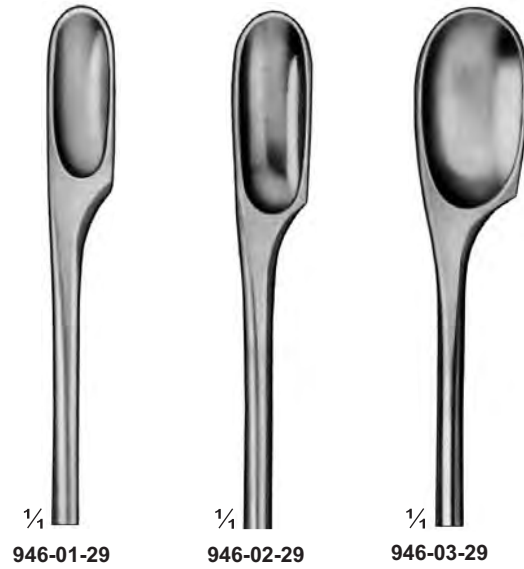

Winter
946-01-29 To 946-03-29
29 cm / 11½"

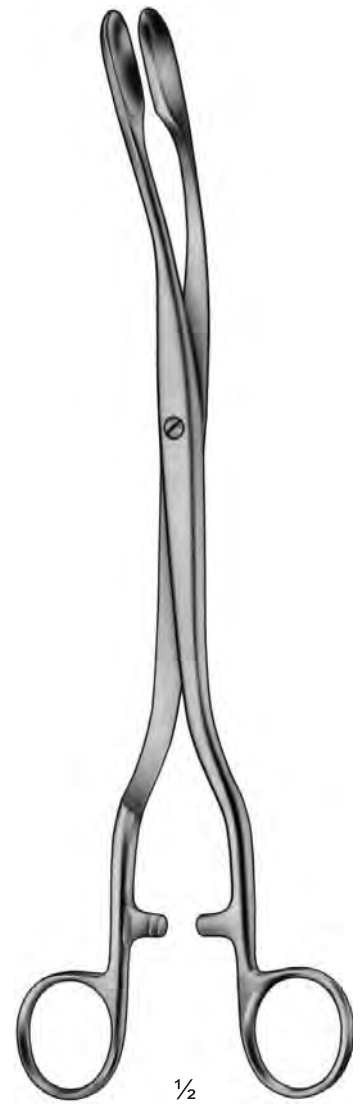

Winter
946-04-29 To 946-06-29
29 cm / 11½"

Abortuszangen
Placenta and Ovum Forceps
Pinces placentaires et pour poste-abortum



**Abortuszangen
Placenta and Ovum Forceps
Pincers placentaires et pour poste-abortum**

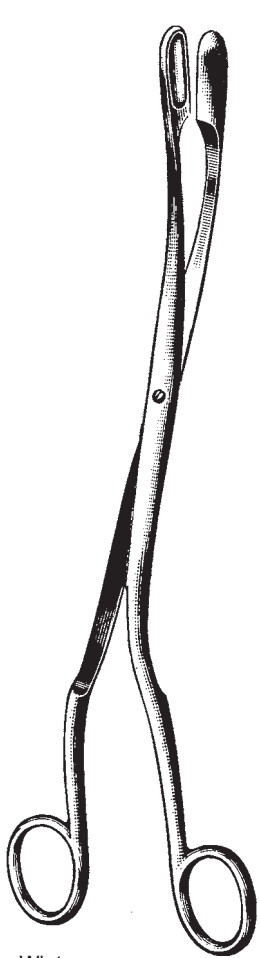

Winter
948-01-27 To 948-03-27
27 cm / 10½"

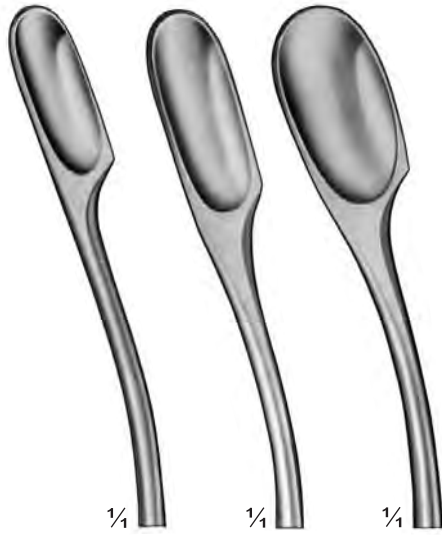

¼ 948-01-27 ¼ 948-02-27 ¼ 948-03-27

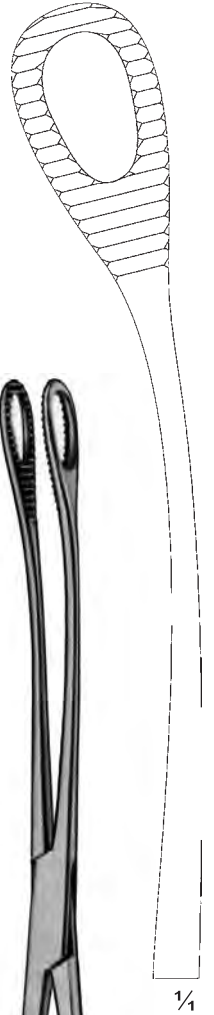

¼

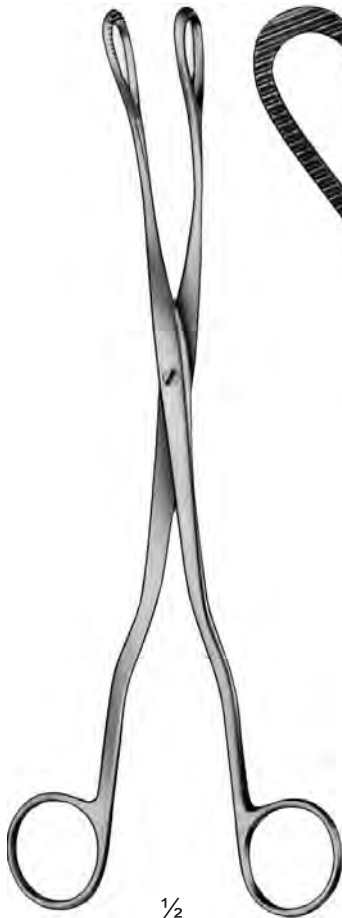

½
Mc Clintock
948-04-24
24 cm / 9½"



¼

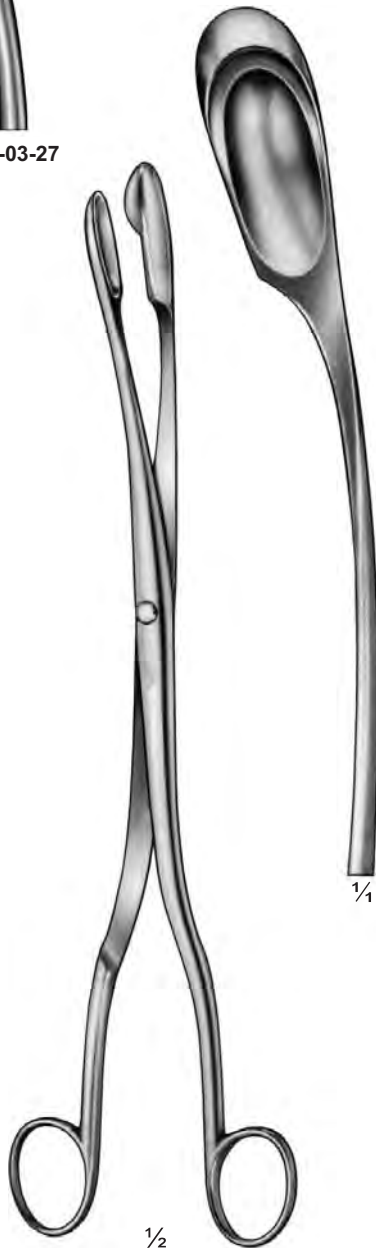

½
948-05-28
28.5 cm / 11¼"

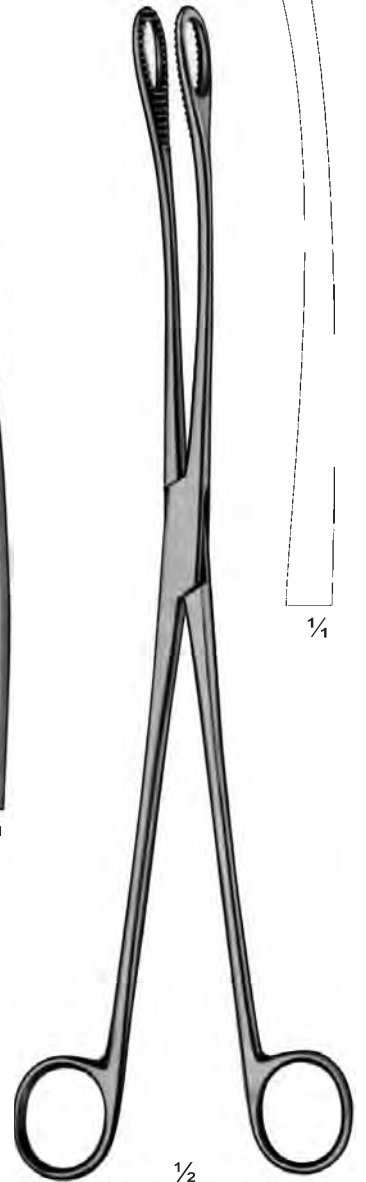

½
Kelly
948-06-32
32 cm / 12¾"

Abortuszangen
Placenta and Ovum Forceps
Pinces placentaires et pour poste-abortum

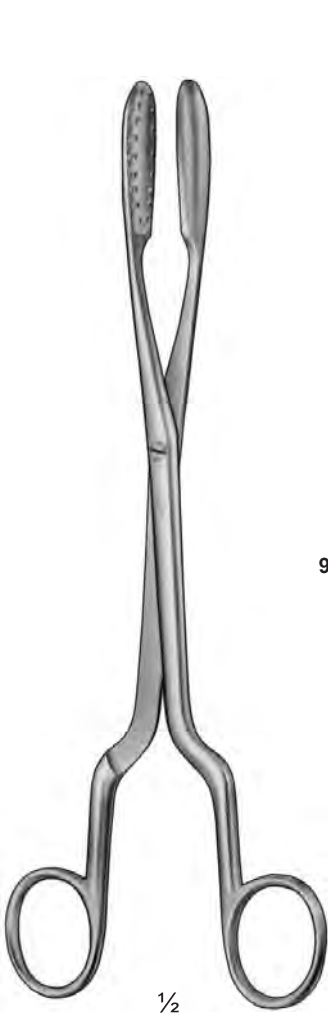

$\frac{1}{2}$
 Lewkowitz
 949-01-24 TO 949-02-24
 24.5 cm / 9 $\frac{3}{4}$ "



$\frac{1}{4}$
 949-01-24



$\frac{1}{4}$
 949-02-24



$\frac{1}{2}$
 Saenger
 949-03-27 TO 949-04-27
 27.5 cm / 10 $\frac{3}{4}$ "



$\frac{1}{4}$
 949-03-27



$\frac{1}{4}$
 949-04-27

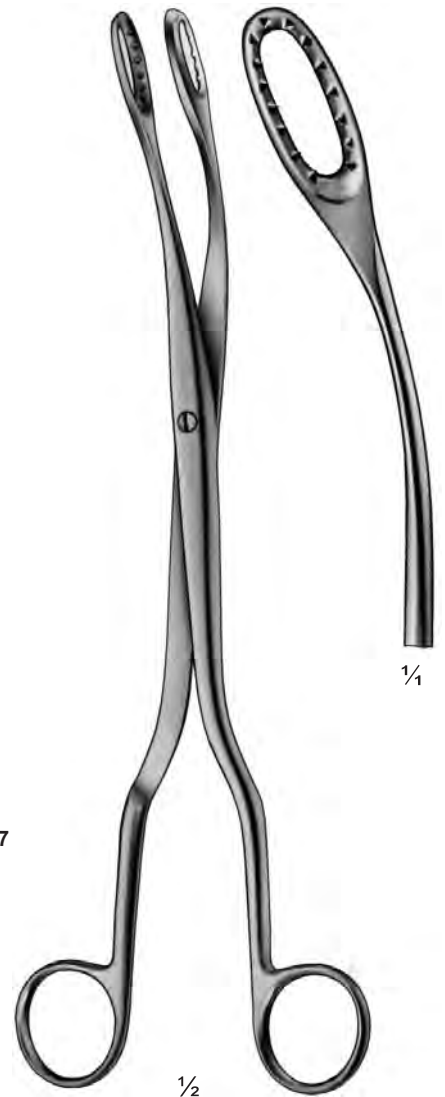

$\frac{1}{2}$
 Saenger
 949-05-28
 28.5 cm / 11 $\frac{1}{4}$ "

$\frac{1}{4}$

**Abortuszangen
Placenta and Ovum Forceps
Pincers placentaires et pour poste-abortum**

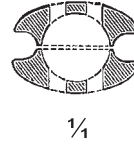
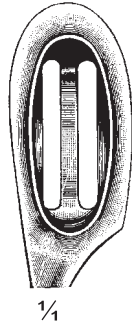
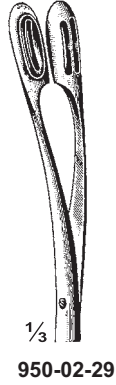
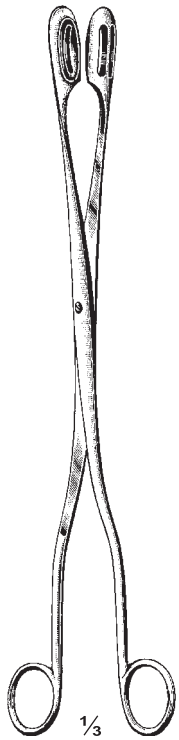

Kranz
950-01-29 & 950-02-29
29 cm / 11½"

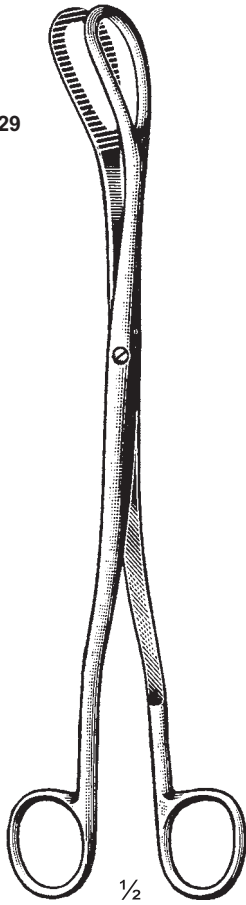

Corey
950-03-24
24 cm / 9½"



Naegele
950-04-26
26 cm / 10¼"



Smellie
950-05-27
27 cm / 10½"



Smellie
950-06-25 25 cm / 10"
950-07-27 27 cm / 10½"

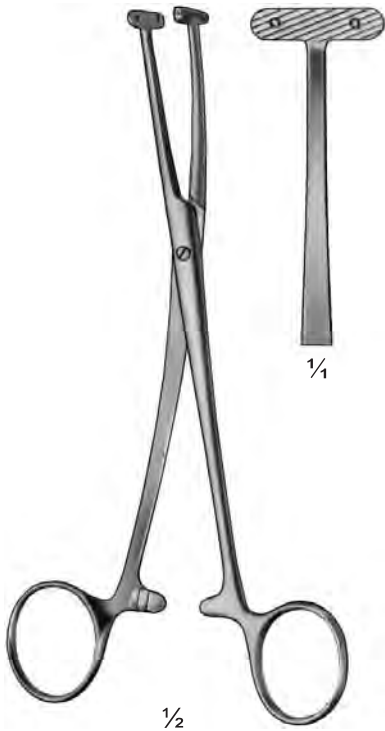

1/2
Willett
951-01-18
18.5 cm / 7 1/4"



1/2
Gauss
951-03-26
26 cm / 10 1/4"

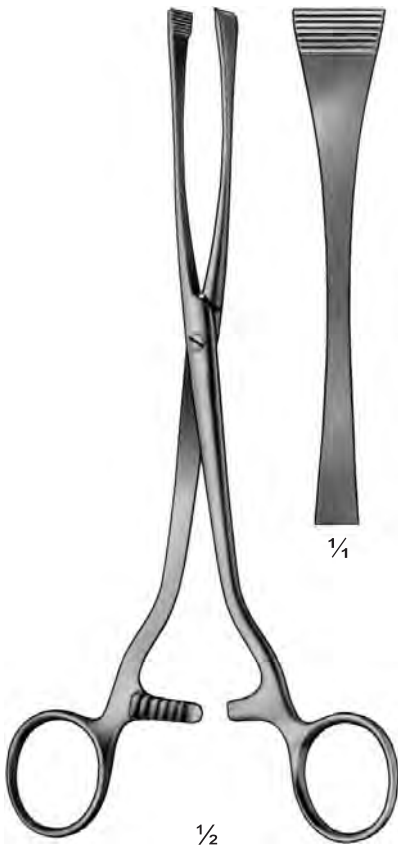

1/2
Green-Armytage
951-02-22
22 cm / 8 3/4"

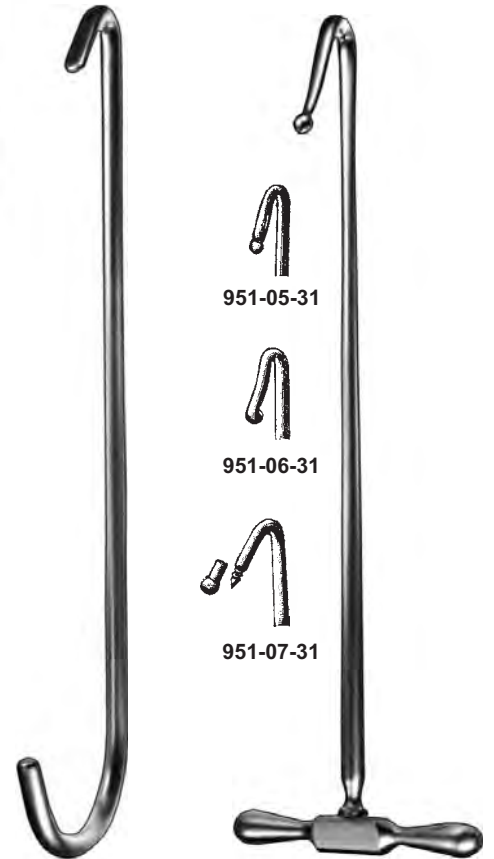

Smellie
951-04-30
30 cm / 12"

Braun
951-05-31 To 951-07-31
31 cm / 12 1/4"



1/3

Cuzzi
952-01-14 To 952-03-21
30 cm / 12"
Blunt

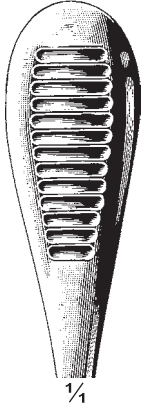

1/4



1/4

952-01-14
14 mm

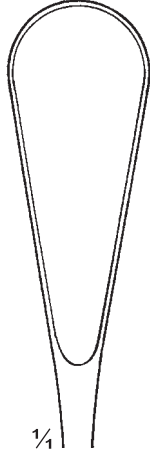

1/4

952-02-18
18 mm

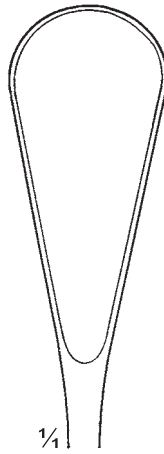

1/4

952-03-21
21 mm



1/3

Pestalozza
952-04-30
30 cm / 12"



1/4



1/4



1/2

Herff
952-05-25
25 cm / 10"

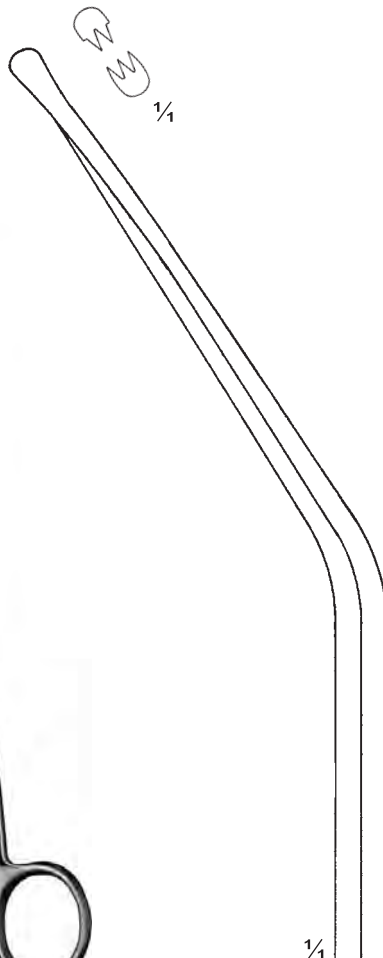

1/4



1/2

Iowa
952-06-26
26 cm / 10 1/4"

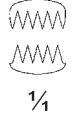

1/4



953-01-10
10.5 cm / 4¼"



Schumacher
953-02-15
15 cm / 6"



953-03-13 & 953-04-16



953-03-13
13.5 cm / 5¼"



953-04-16
16 cm / 6¼"



Braun-Stadler
953-05-14 14.5 cm / 5¾"
953-06-20 20 cm / 8"
Episiotomy Scissors

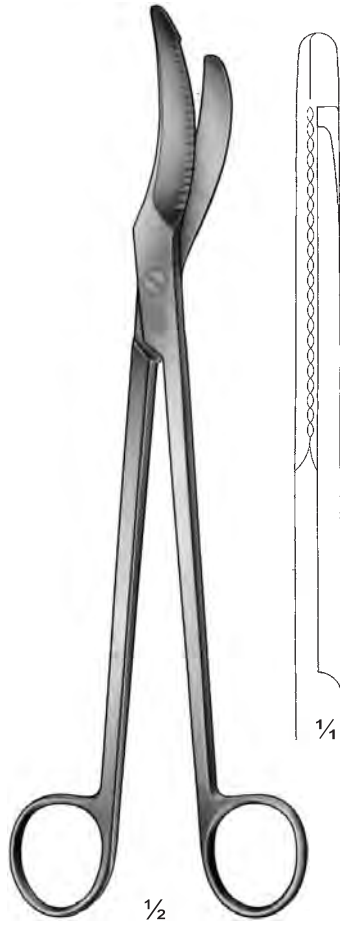

953-07-24
24 cm / 9½"
Episiotomy Scissors

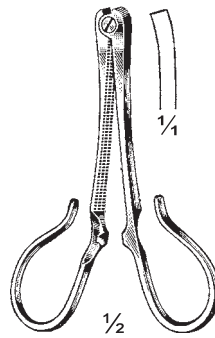

Kane
953-08-08
8.5 cm / 3¼"

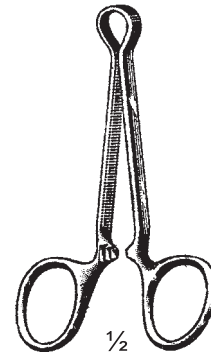

Collin
953-09-09
9 cm / 3½"

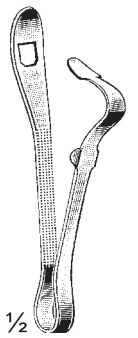

Collin
953-10-09
9 cm / 3½"



De Lee
954-01-15
15 cm / 6"
For interior
measurements
between symphysis
and promontory

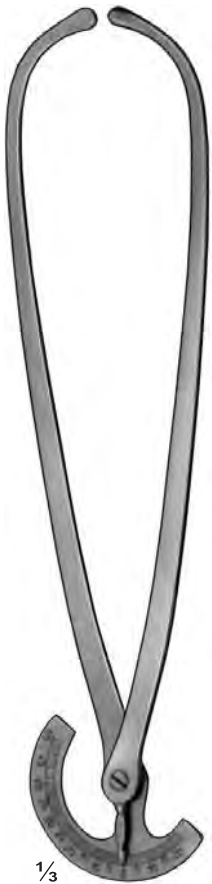

$\frac{1}{3}$
Collin
954-02-34
34.5 cm / 13 $\frac{3}{4}$ "
Graduated in centimeters



954-03-39
39 cm / 15 $\frac{1}{2}$ "
Graduated in centimeters



Schneider
954-04-39
39 cm / 15 $\frac{1}{2}$ "
The additional straight
arm can be replaced.





$\frac{1}{3}$

Breisky
955-01-33
33 cm / 13 $\frac{1}{4}$ "
Graduated in centimeters

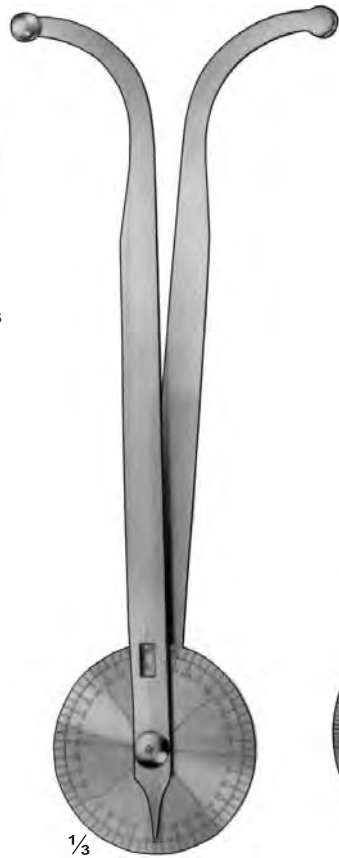

$\frac{1}{3}$

Thole
955-03-33
33 cm / 13 $\frac{1}{4}$ "
Graduated in centimeters

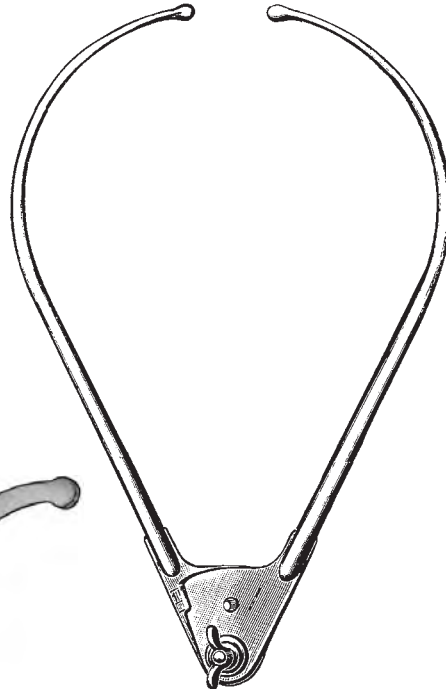

Collyer
955-02-33
33 cm / 13 $\frac{1}{4}$ "
Graduated in centimeters

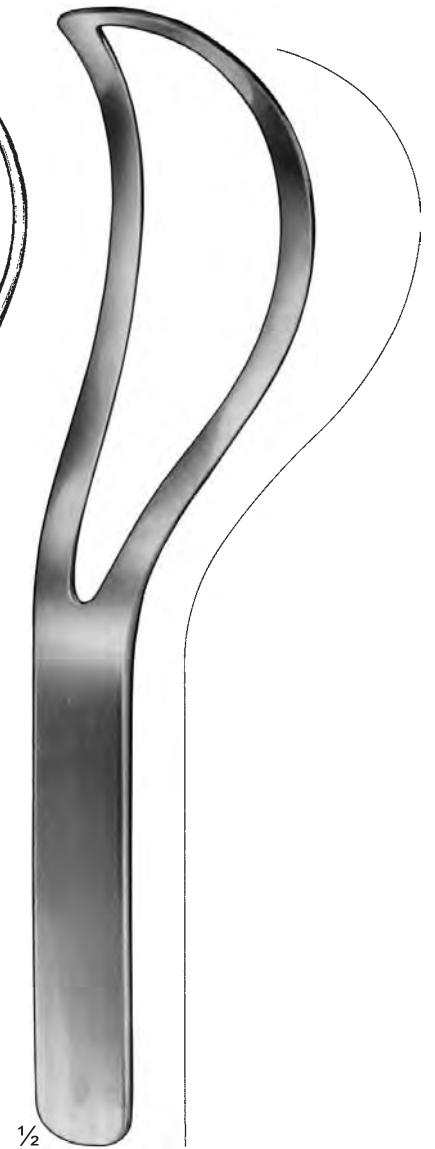
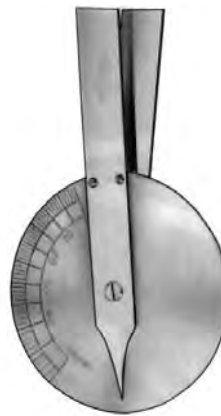

$\frac{1}{2}$

Sellheim
955-04-30
30 cm / 12"

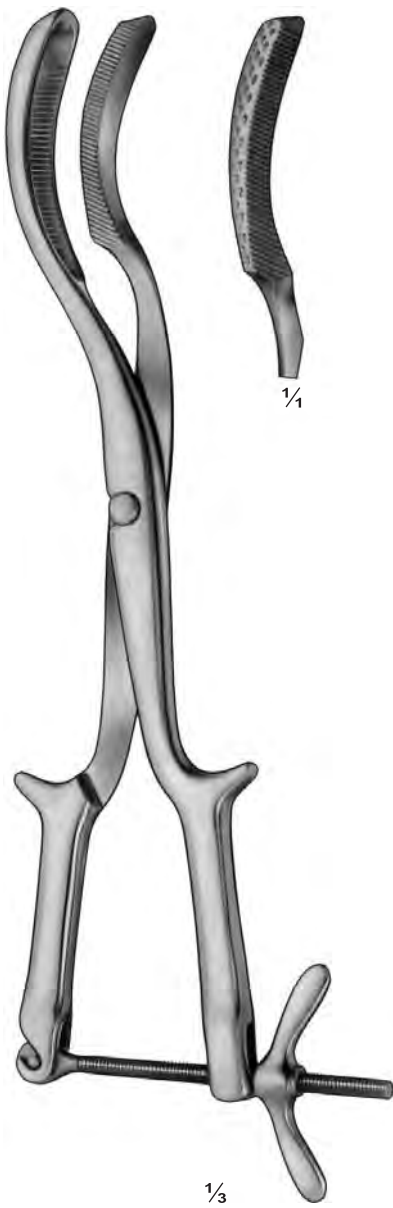

Braun
956-01-42
42 cm / 16³/₄"
1 Jaw fenestrated

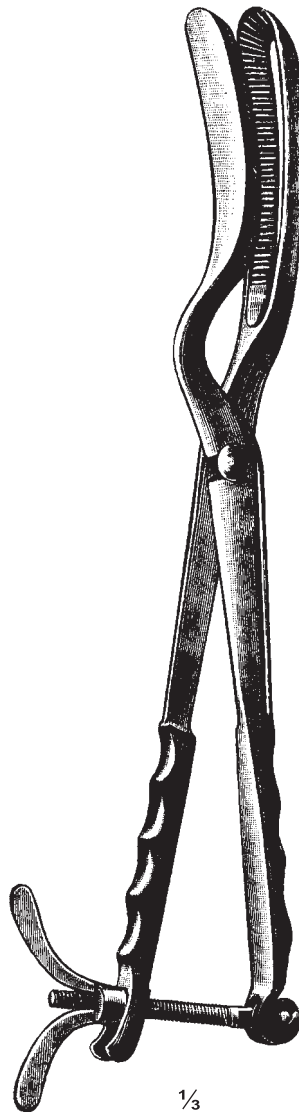

Baren's
956-02-42
42 cm / 16³/₄"

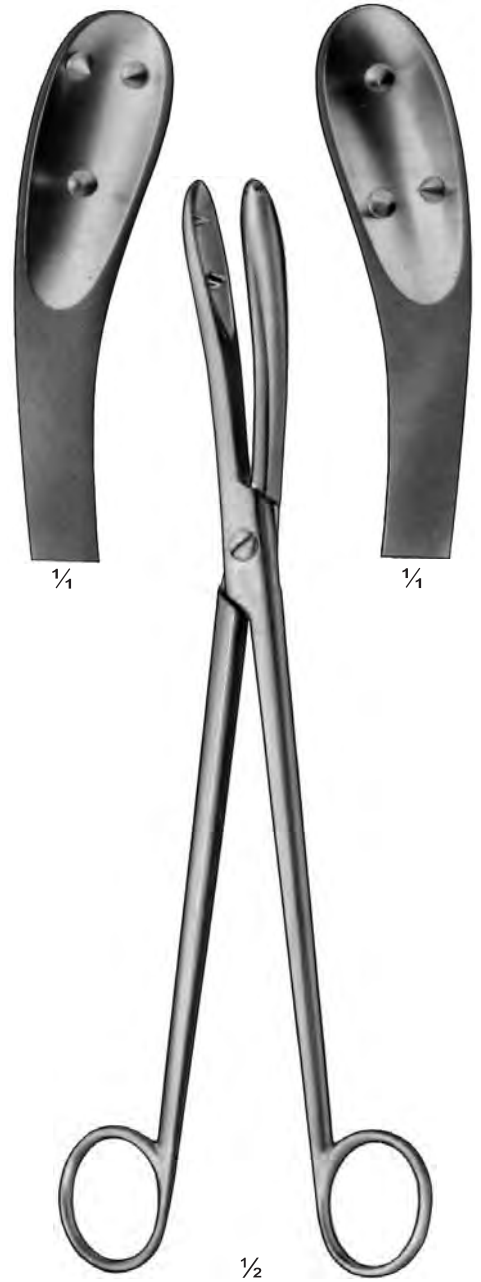

Boer
956-03-29
29 cm / 11¹/₂"
Craniotomy forceps



$\frac{1}{3}$
Tarnier
957-01-44
44 cm / 17 $\frac{1}{2}$ "

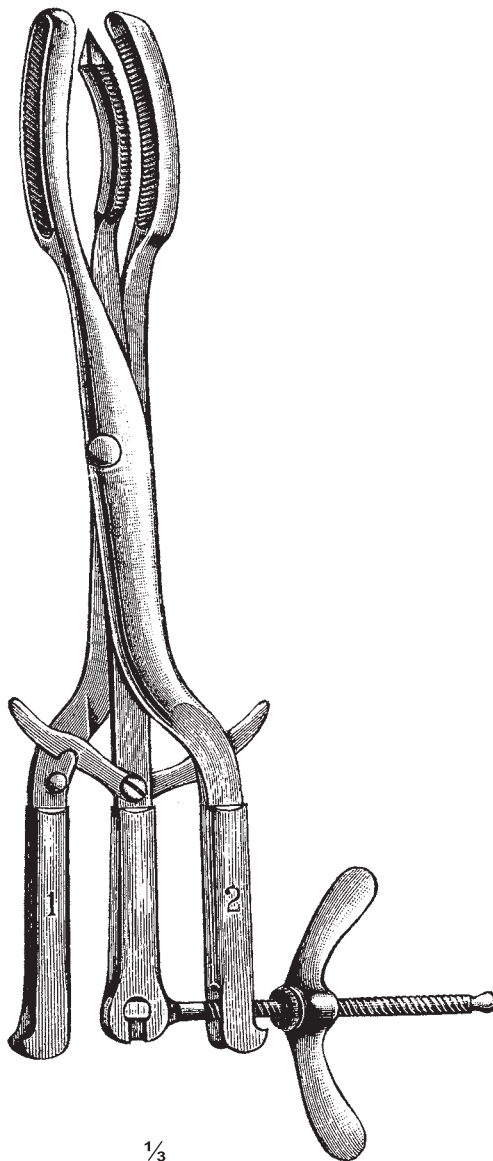

$\frac{1}{3}$
Auvard
957-02-42
42 cm / 16 $\frac{3}{4}$ "

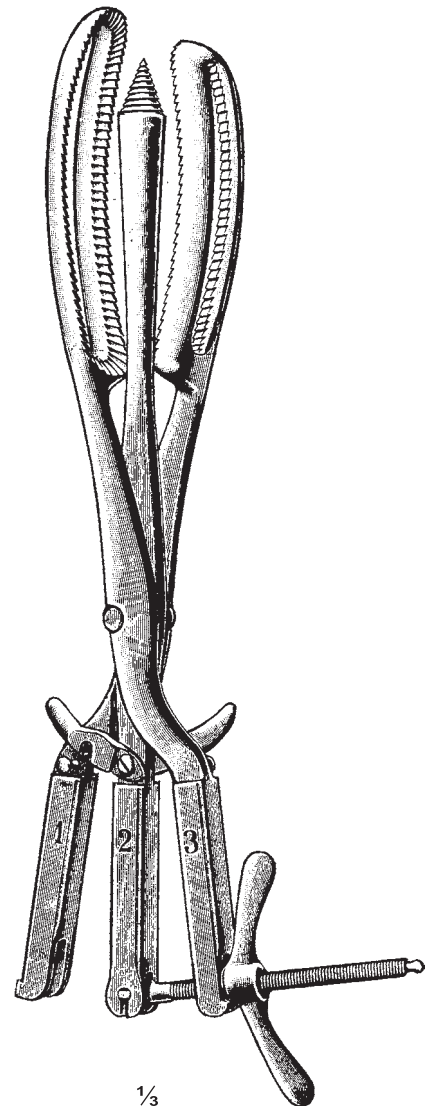

$\frac{1}{3}$
Auvard-Zweifel
957-03-42
42 cm / 16 $\frac{3}{4}$ "

**Beckenzirkel
Pelvimeter
Pelvimètre**

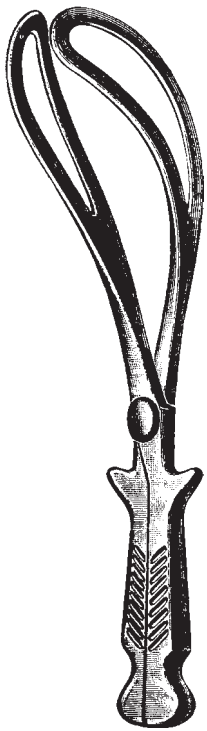

Naegele
958-03-35 35 cm / 14"
958-04-40 40 cm / 16"

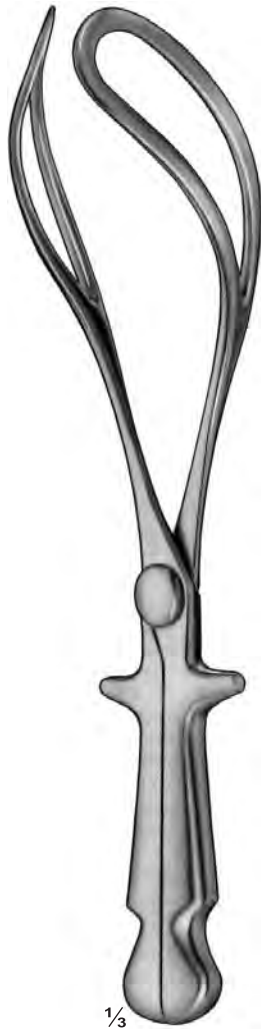

Naegele
958-05-35 35 cm / 14"
958-06-40 40 cm / 16"



$\frac{1}{3}$
Simpson
958-01-23
23.5 cm / 9 $\frac{1}{4}$ "



$\frac{1}{3}$
Wrigley
958-02-25
25 cm / 10"

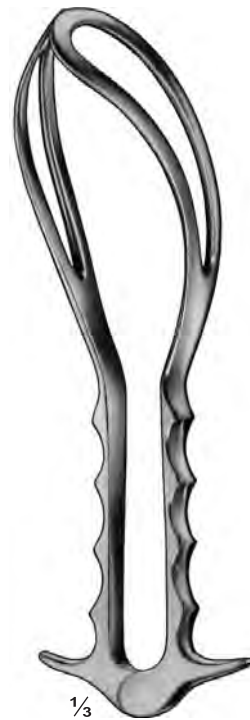

$\frac{1}{3}$
Boerma
958-07-28
28 cm / 11"

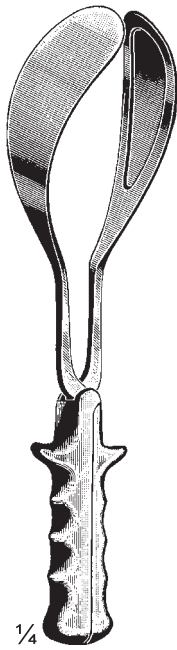

1/4

Simpson-Luikart
959-01-36
36 cm / 14 1/4"



1/3

Simpson-Braun
959-02-30
30 cm / 12"



1/3

Simpson-Braun
959-03-35
35 cm / 14"

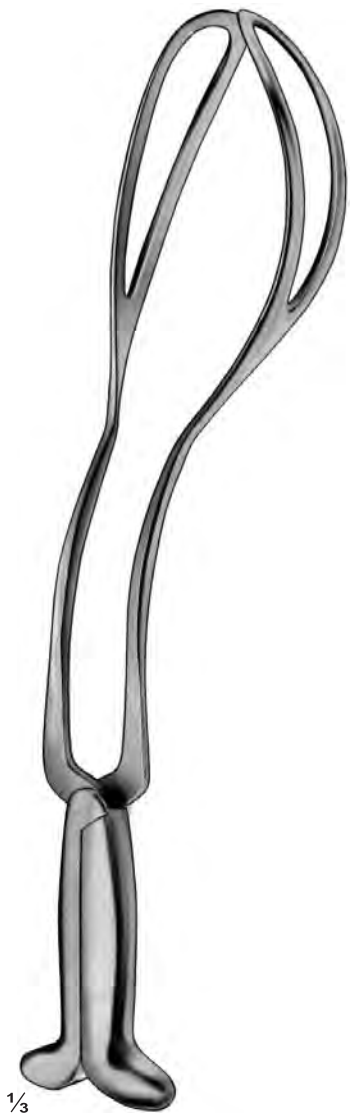

1/3

Piper
959-04-44
44.5 cm / 17 1/2"

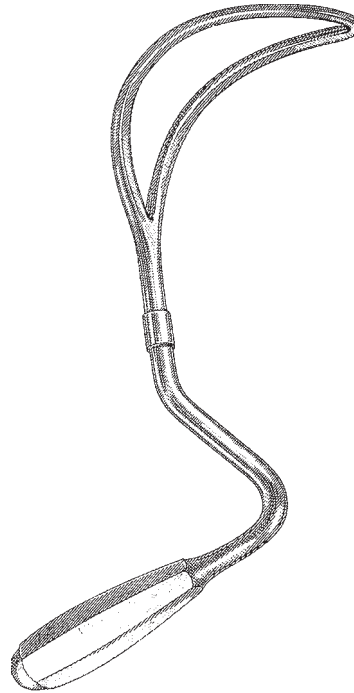

Murless
960-01-25
25 cm / 10"
With hinged shaft
and sliding collar lock



$\frac{1}{3}$
Kielland
960-02-39 39 cm / 15½"
960-03-42 42 cm / 16¾"



Kielland-Luikart
960-04-39 39 cm / 15½"
960-05-42 42 cm / 16¾"

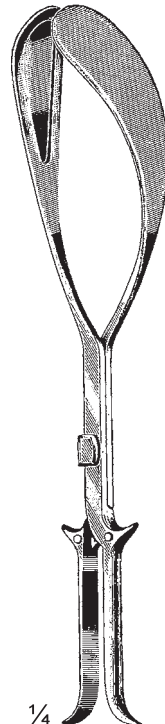

$\frac{1}{4}$
Luikart
960-06-39
39 cm / 15½"

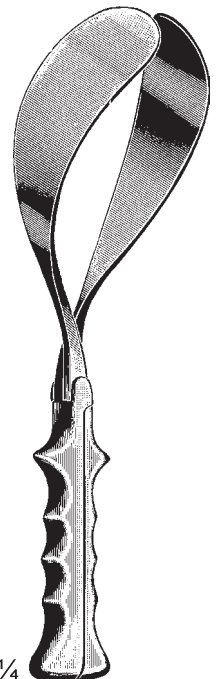

$\frac{1}{4}$
Mc Lean
960-07-36
36 cm / 14¼"

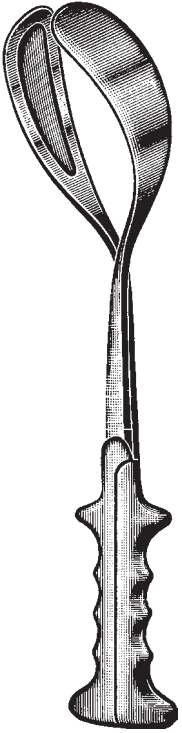

Mc Lean-Luikart
961-01-38
38 cm / 15¼"

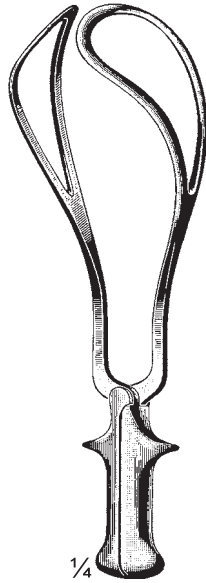

¼
De Lee
961-02-30
30 cm / 12"

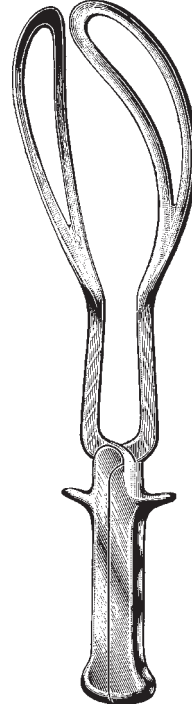

De Lee
961-03-36 36 cm / 14¼"
961-04-39 39 cm / 15½"

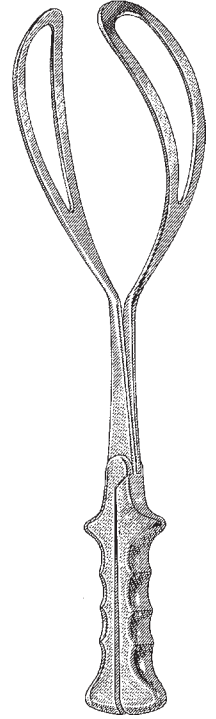

Bailey-Williamson
961-05-39
39 cm / 15½"

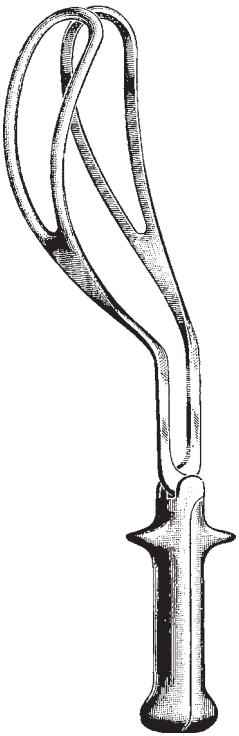

Hawks-Dennen
961-06-37
37.5 cm / 15"

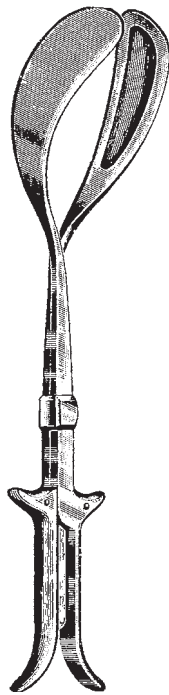

Mc Lean-Tucker-Luikart
961-07-39
39.5 cm / 15¾"

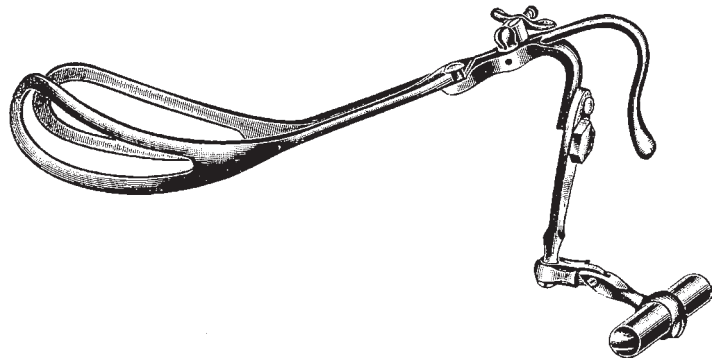

Dewey
961-08-35
35 cm / 14"

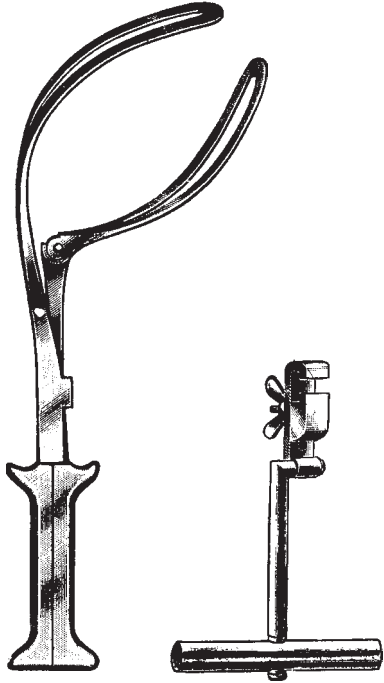

Barton
962-01-35
35 cm / 14"
With traction handle



Barens
962-02-36 36 cm / 14¼"
962-03-39 39 cm / 15½"



Anderson
962-04-39
39 cm / 15½"

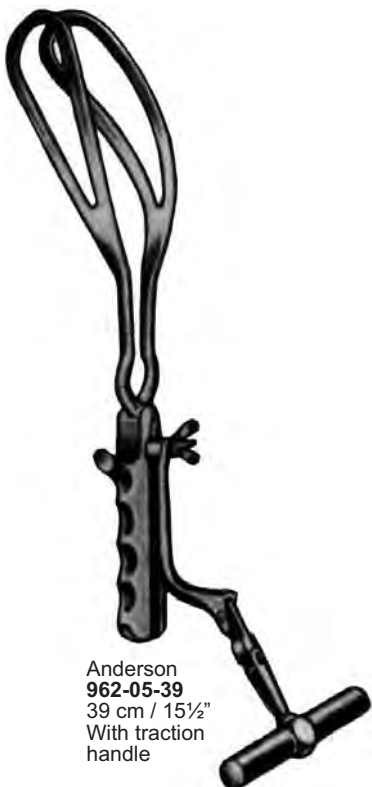

Anderson
962-05-39
39 cm / 15½"
With traction handle

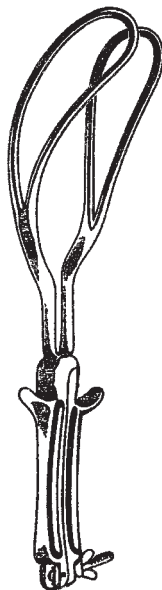

K. N. Dass
962-06-35
35 cm / 14"

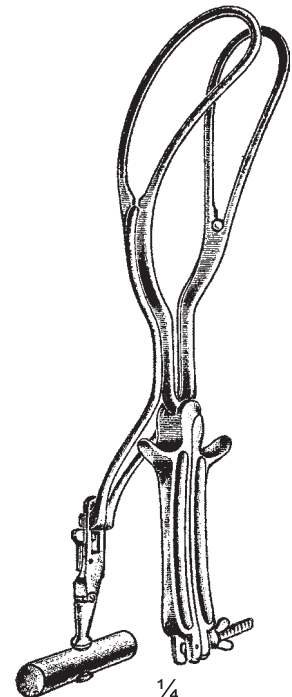

K. N. Dass
962-07-35
35 cm / 14"
With traction handle

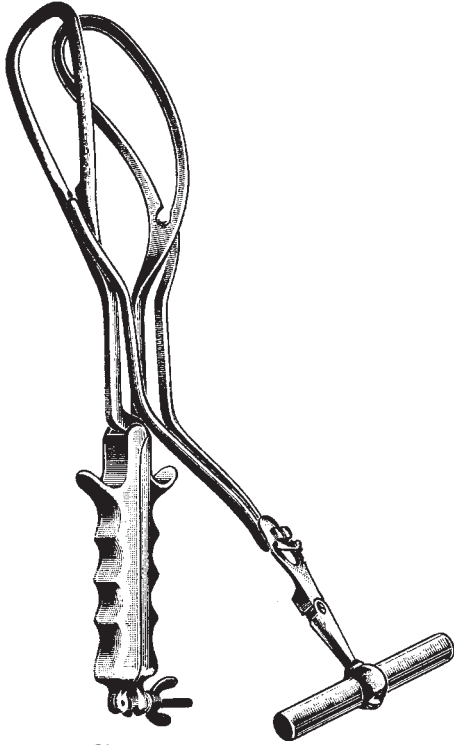

Simpson
963-01-37
37 cm / 14³/₄"

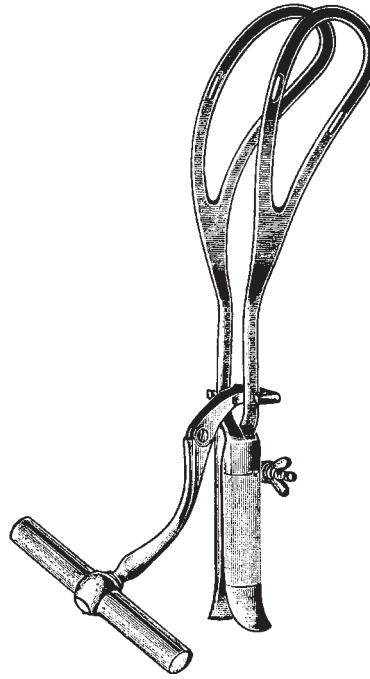

Haig-Fergusson
963-02-34
34 cm / 14"

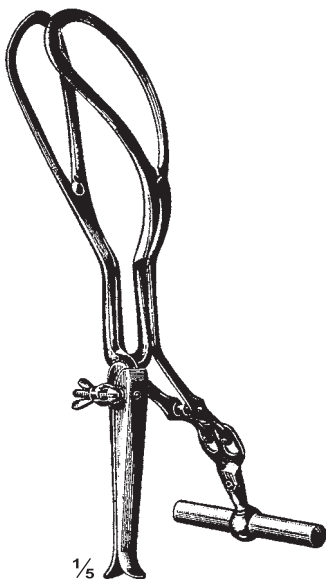

¹/₅
Milne-Murray
963-03-38
38 cm / 15"

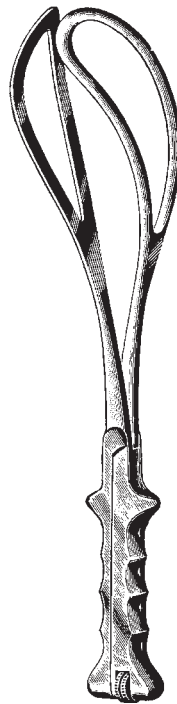

Elliot
963-04-32 32 cm / 12¹/₂"
963-05-38 38 cm / 15"



Demelis
963-06-00

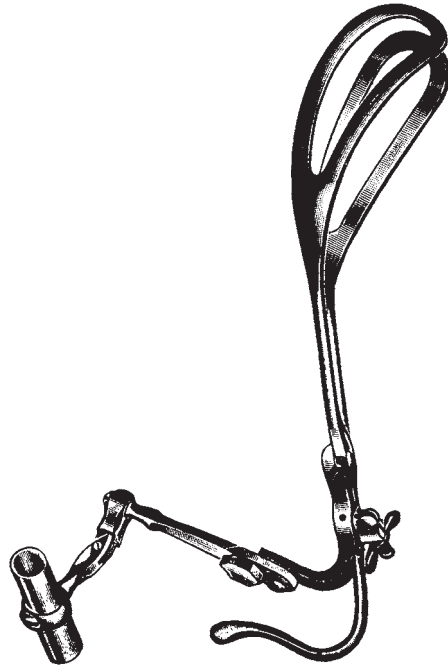

Deweys
964-01-35
35 cm / 14"
With traction handle

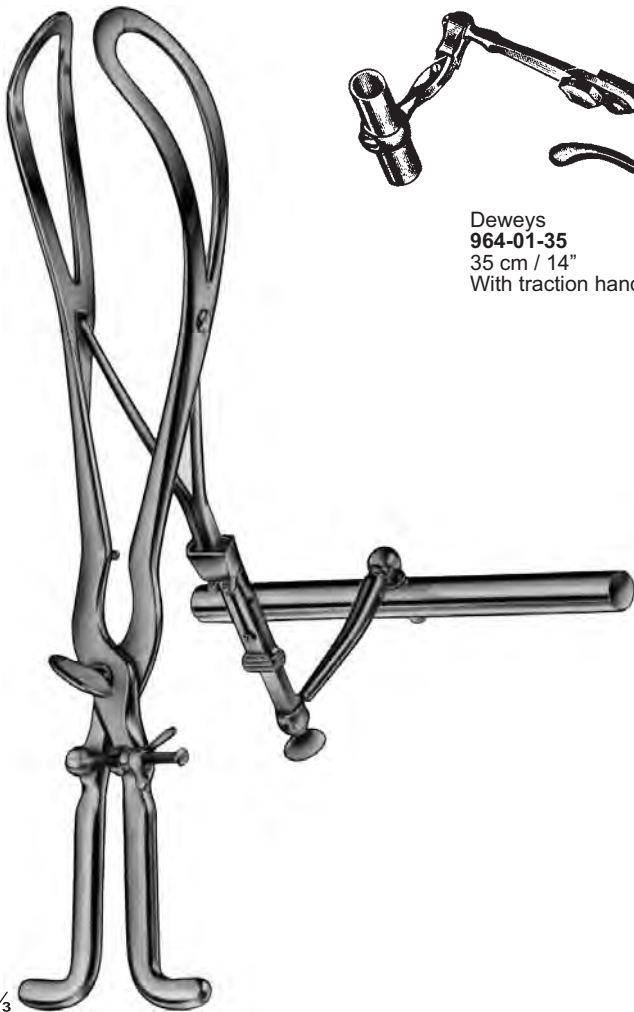

$\frac{1}{3}$

Tarnier
964-02-40
40 cm / 16"
With traction rod



$\frac{1}{3}$

Barnes-Neville
964-03-43
43.5 cm / 17"
With traction handle

Sterilisierzangen
Sterilizing Forceps
Pinces pour instruments stérilisés

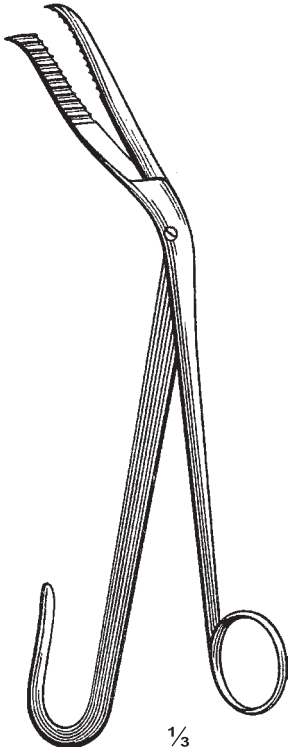

Cheattle
965-01-28 28 cm / 11"
965-02-30 30 cm / 12"

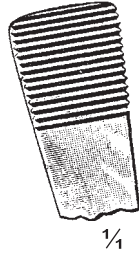

1/4



London-Hospital
965-03-28 28 cm / 11"
965-04-30 30 cm / 12"



Ulleval
965-05-24
 24 cm / 9½"

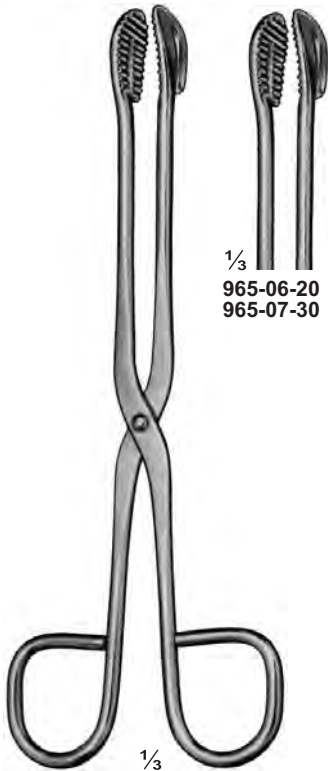

965-06-20 To 965-09-30



1/3
965-06-20
965-07-30



1/3
 20 cm / 8" **965-08-20**
 30 cm / 12" **965-09-30**



1/3
965-10-20 20 cm / 8"
965-11-25 25 cm / 10"
965-12-30 30 cm / 12"



1/3
Rogge
965-13-23
 23.5 cm / 9¼"

Sterilisierzangen
Sterilizing Forceps
Pinces pour instruments stérilisés

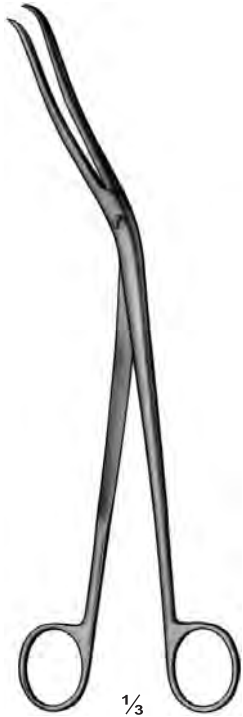

Cheattle
966-01-28
 28 cm / 11"

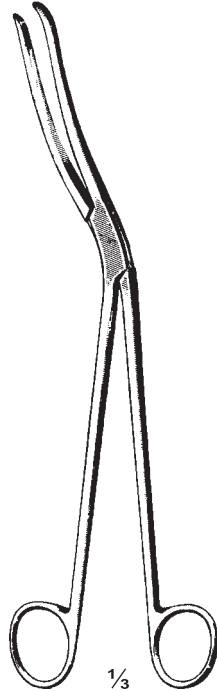

Cheattle
966-02-28
 28 cm / 11"

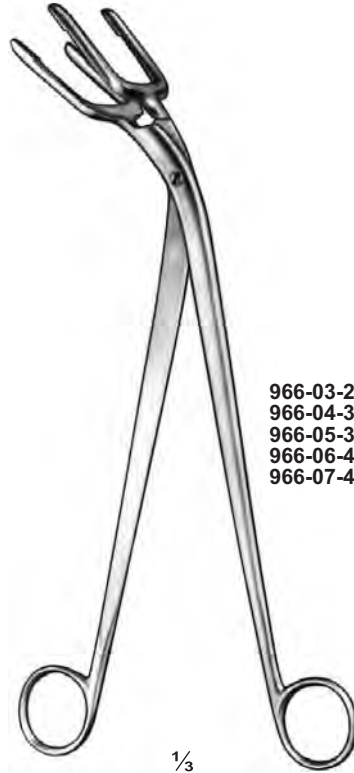

Pye-Smith (Harrison)
966-03-25 To 966-07-45

966-03-25	25 cm / 10"	966-08-25
966-04-30	30 cm / 12"	966-09-30
966-05-35	35 cm / 14"	966-10-35
966-06-40	40 cm / 16"	966-11-40
966-07-45	45 cm / 18"	966-12-45

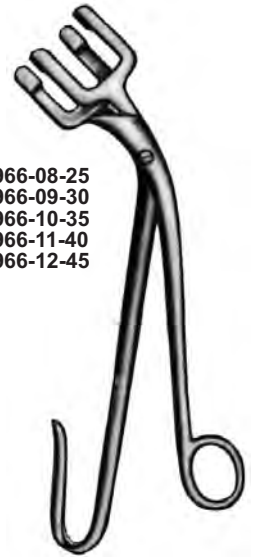

Pye-Smith (Harrison)
966-08-25 To 966-12-45

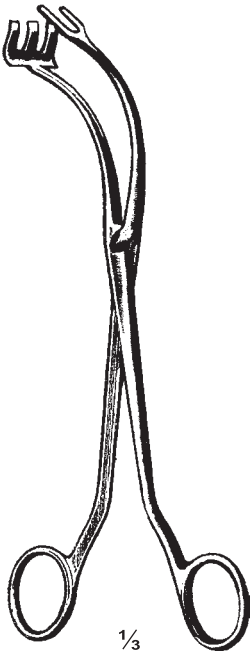

Collin
966-13-24 24 cm / 9½"
966-14-30 30 cm / 12"

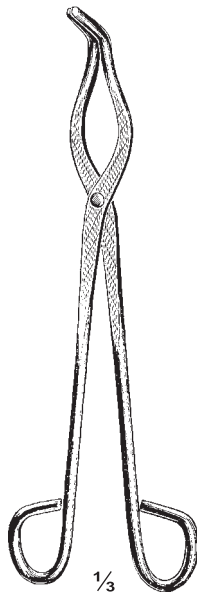

966-15-23 23 cm / 9"
966-16-30 30 cm / 12"
966-17-50 50 cm / 20"

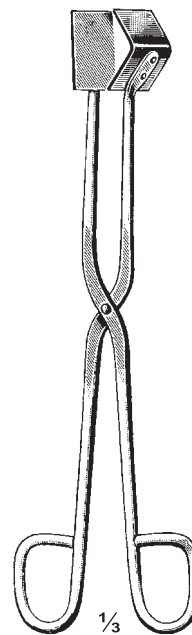

966-18-24
 24 cm / 9½"



966-18-58
 58 cm / 22¾"

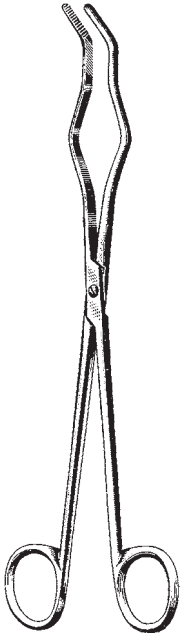

967-01-24
24.5 cm / 9¾"

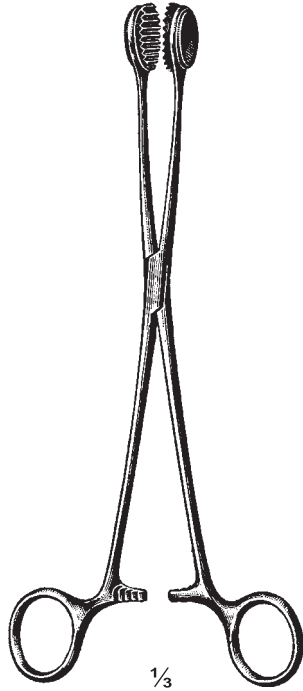

967-02-24
24 cm / 9½"

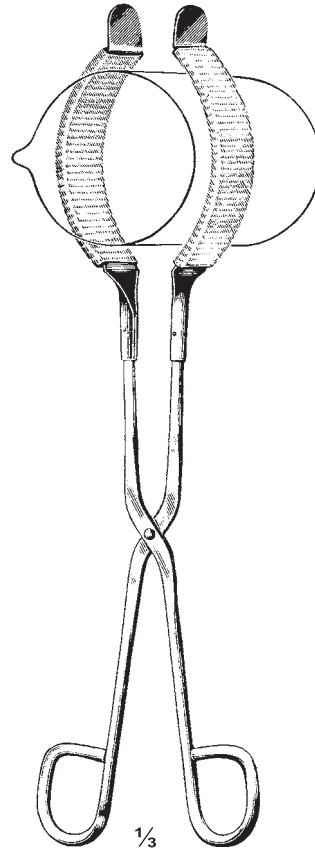

967-03-33
33 cm / 13"

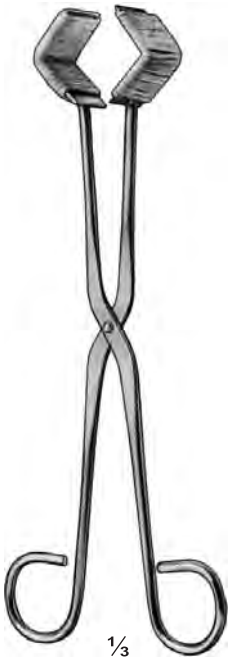

967-04-25
25 cm / 10"

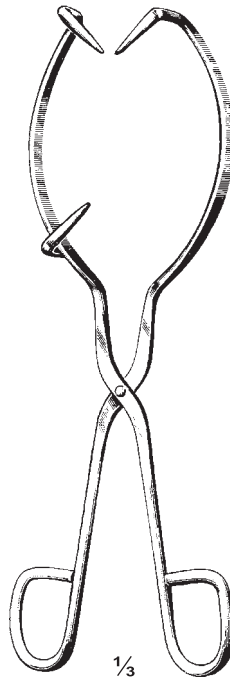

967-05-26
26 cm / 10¼"

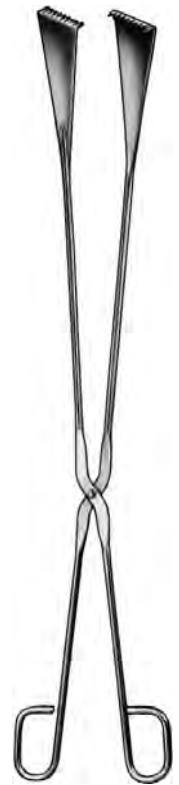

Sauerbruch
967-06-55
55 cm / 21½"

**Sterilisierzangen
Sterilizing Forceps
Pincettes pour instruments stérilisés**



968-01-20
20 cm / 8"



968-02-17
17 cm / 6 3/4"



Davis
968-03-16 16 cm / 6 1/4"
968-04-20 20 cm / 8"
968-05-24 24 cm / 9 1/2"

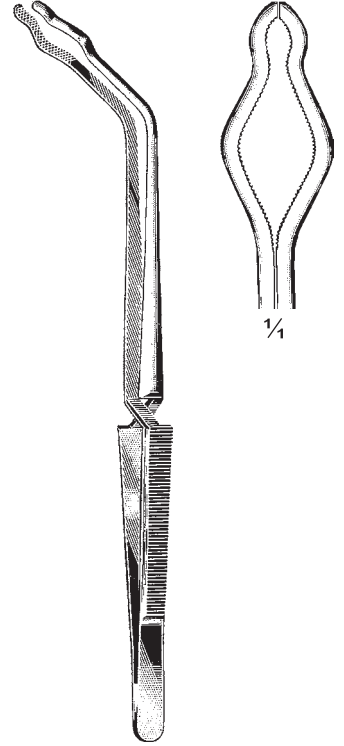

968-06-18 18 cm / 7"
968-07-25 25 cm / 10"



Boley
968-08-14
14 cm / 5 1/2"
Sliding caliper
Measuring capacity 0-100 mm

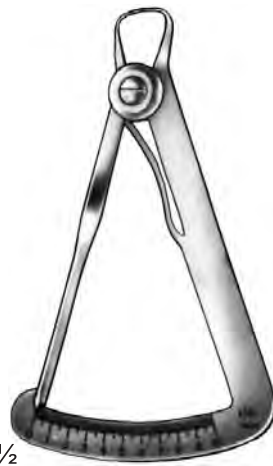

Iwanson
968-09-12
12 cm / 4 3/4"
Decimal spring caliper
Measuring capacity 0-10 mm



968-10-16
16 cm / 6 1/4"
Decimal spring caliper
Measuring capacity 0-15 mm

Sterilisierklammer, Schlauchklemmen
Safety Pins, Tubing Clamps
Clips de stérilisation, Pincettes presse-tubes

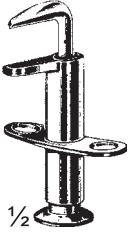

$\frac{1}{2}$
 Ulrich
969-01-06
 6 cm / 2¼"



$\frac{1}{2}$
 Ulrich
969-02-06
 6 cm / 2¼"

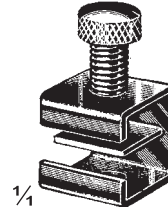

$\frac{1}{4}$
 Simplex
969-03-12
 12 mm

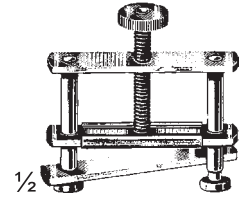

$\frac{1}{2}$
 Hoffmann
969-04-13 13 mm
969-05-17 17 mm
969-06-20 20 mm
969-07-25 25 mm
969-08-30 30 mm
969-09-40 40 mm
969-10-50 50 mm

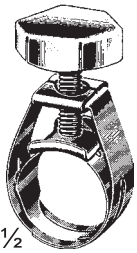

$\frac{1}{2}$
 For diameter
969-11-12 12-17 mm
969-12-16 16-21 mm
969-13-20 20-25 mm
969-14-24 24-29 mm

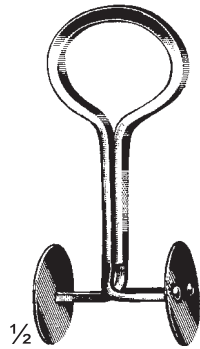

$\frac{1}{2}$
 Mohr
969-15-50 50 mm
969-16-60 60 mm
969-17-70 70 mm
969-18-80 80 mm

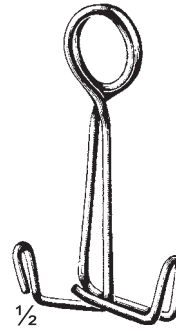

$\frac{1}{2}$
 Sell
969-19-80
 80 mm

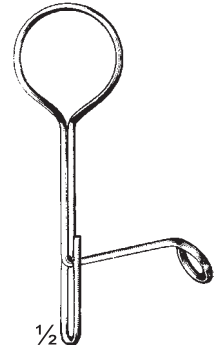

$\frac{1}{2}$
 Holt
969-20-70
 70 mm

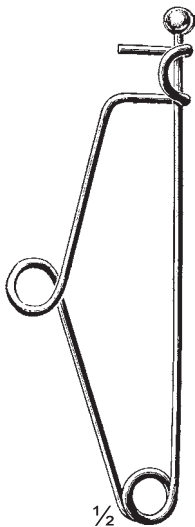

$\frac{1}{2}$
 Mayo
969-21-14
 14 cm / 5½"

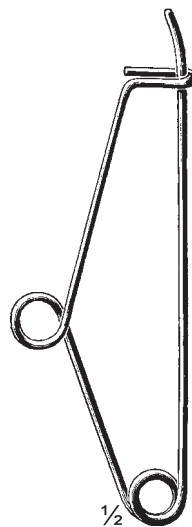

$\frac{1}{2}$
 Mayo
969-22-14
 14 cm / 5½"



$\frac{1}{2}$
 Bunt
969-23-12
 12 cm / 4¾"

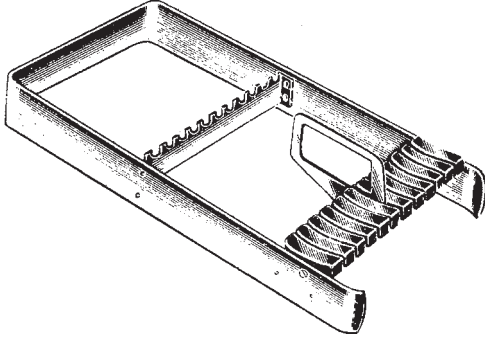

970-01-220
220 X 113 X 45 mm
For 12 micro instruments
of 19 cm length

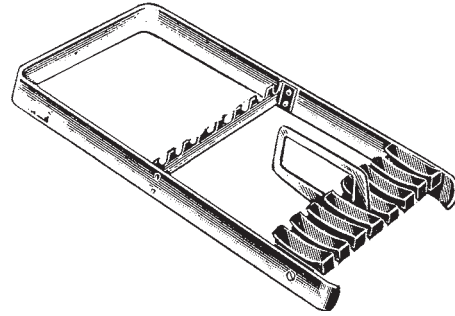

970-02-190
190 X 97 X 32 mm
For 8 micro instruments
of 17 cm length

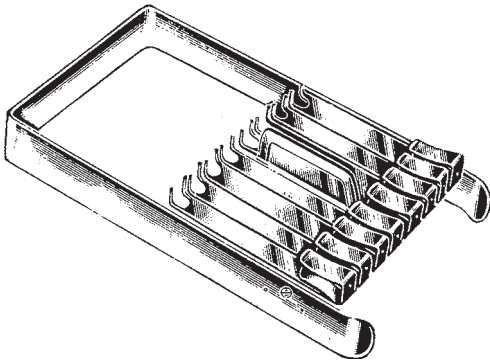

970-03-220
220 X 113 X 45 mm
For 6 micro instruments
of 19 cm length

970-04-220
220 X 113 X 45 mm
For 8 micro instruments
of 19 cm length



970-05-120
120 X 65 X 13 mm
Box for bulldog clamps
Without clamps and silicone tape



970-06-120
120 X 65 X 13 mm
Box with support for bulldog clamps
Without clamps



970-07-120
120 X 65 X 13 mm
Box with support for needle electrodes
Without instruments

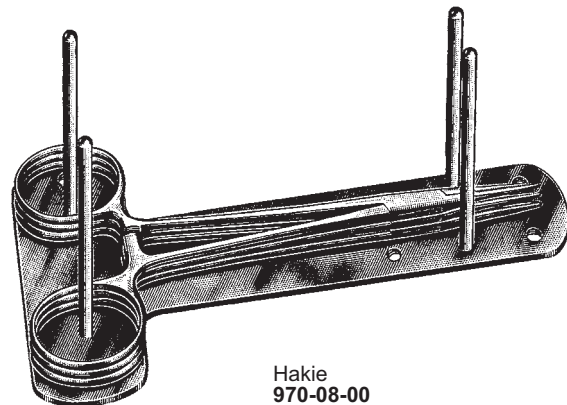

Haki
970-08-00
Sterilizing rack



971-01-205
205 X 120 X 13 mm
Perforated lid and bottom



971-02-150
150 X 95 X 13 mm
Non-perforated lid and bottom



971-03-150
150 X 95 X 13 mm
Perforated lid and bottom



971-04-150
150 X 95 X 13 mm
Non-perforated lid and
perforated bottom



971-05-150
150 X 95 X 13 mm
Perforated lid and bottom



971-06-150
150 X 95 X 13 mm
Non-perforated lid and bottom
Without rack



971-07-150
150 X 95 X 13 mm
Perforated lid and bottom
Without rack



971-08-150
150 X 95 X 7 mm
Non-Perforated bottom
Rack only

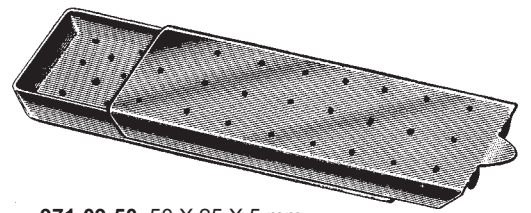

971-09-50 50 X 25 X 5 mm
971-10-65 65 X 42 X 8 mm
971-11-75 75 X 25 X 5 mm
Perforated lid and bottom



971-12-150
150 X 95 X 11 mm
Perforated bottom
Rack only

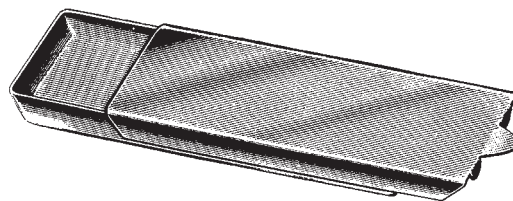

971-13-50 50 X 25 X 5 mm
971-14-65 65 X 42 X 8 mm
971-15-75 75 X 25 X 5 mm
Non-Perforated lid and bottom

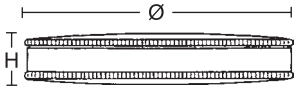

972-01-65
Ø 65 X 15 mm
Complete



972-02-62
Ø 62 X 12 mm
Insert only



972-03-135
135 X 100 X 25 mm



972-04-200 200 X 100 X 25 mm
972-05-230 230 X 130 X 25 mm
972-06-275 275 X 230 X 25 mm
Micro Instrument tray with
silicone mat



	L	B	H
973-01-240	240 X 240 X		50 mm
973-02-240	240 X 240 X		80 mm
973-03-240	240 X 240 X		100 mm
973-04-480	480 X 260 X		50 mm
973-05-520	520 X 260 X		80 mm
973-06-520	520 X 260 X		100 mm

Perforated steel sheet



973-07-00
 Storing cup for micro instruments
 with silicon bottom plate



973-08-00
 Sterilizing forceps consisting of :
 1 Sterilizing forceps, 25cm, Cur
 without ratchet, with lid for jar
 1 Jar with wide bottom plate (anti-tilt)
973-09-32 Complete with 32 cm long Sterilizing Forceps

Containers

	L	B	H	Set of special filters (5pairs)
974-01-230	230	130	50	974-17-230
974-02-26	260	150	50	974-18-260
974-03-275	275	235	50	974-19-275
974-04-300	300	200	50	974-20-300
974-05-325	325	275	50	974-21-35
974-06-400	400	200	50	974-22-400
974-07-420	420	175	50	974-23-420
974-08-500	500	200	50	974-24-500
974-09-230	230	130	75	974-25-230
974-10-260	260	150	75	974-26-260
974-11-275	275	235	75	974-27-275
974-12-300	300	200	75	974-28-300
974-13-325	325	275	75	974-29-325
974-14-400	400	200	75	974-30-400
974-15-420	420	175	75	974-31-420
974-16-500	500	200	75	974-32-500

Perforated lid

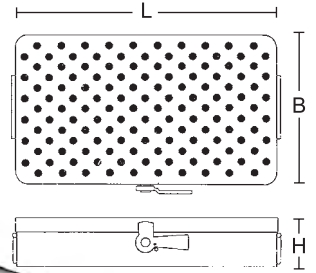

974-33-135 Ø H
135 X 40
Lid with knob
974-34-135 135 X 40
Lid without knob

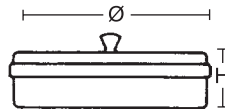

974-35-135 Ø H
135 X 40
Lid with knob
974-36-135 135 X 40
Lid without knob
Perforated lid

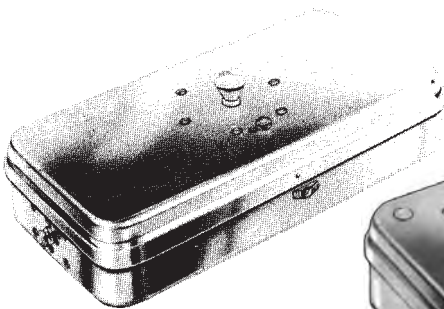

974-37-200 L B H
200 X 100 X 40
Lid with knob
974-38-200 200 X 100 X 40
Lid without knob



974-39-200 L B H
200 X 100 X 40
Lid with knob
974-40-200 200 X 100 X 40
Lid without knob
Perforated lid



Perforated bottom			Non-Perforated bottom	
L	B	H		
974-41-195	195	95	35	974-47-195
974-42-225	225	125	40	974-48-225
974-43-255	255	145	40	974-49-255
974-44-295	295	195	40	974-50-295
974-45-320	320	270	40	974-51-320
974-46-415	415	170	40	974-52-415



975-01-245
245 X 135 X 35 mm
Perforated bottom



Perforated bottom
of 975-01-245 To 975-03-245



975-02-245
245 X 135 X 50 mm
Perforated bottom



975-03-245
245 X 135 X 60 mm
Perforated bottom



975-04-00 Stand Only
975-05-00
Complete consisting of :
1 Pc Stand
3 Pcs Box 975-03-245
1 Pc Box 975-02-245
1 Pc Box 975-01-245



**Konrich
976-01-140 To 976-56-390**



Ø	H				
140 X 140 mm		976-01-140	976-15-140	976-29-140	976-43-140
160 X 150 mm		976-02-160	976-16-160	976-30-160	976-44-160
190 X 160 mm		976-03-190	976-17-190	976-31-190	976-45-190
190 X 190 mm		976-04-190	976-18-190	976-32-190	976-46-190
240 X 120 mm		976-05-240	976-19-240	976-33-240	976-47-240
240 X 160 mm		976-06-240	976-20-240	976-34-240	976-48-240
240 X 240 mm		976-07-240	976-21-240	976-35-240	976-49-240
290 X 160 mm		976-08-290	976-22-290	976-36-290	976-50-290
290 X 240 mm		976-09-290	976-23-290	976-37-290	976-51-290
340 X 160 mm		976-10-340	976-24-340	976-38-340	976-52-340
340 X 240 mm		976-11-340	976-25-340	976-39-340	976-53-340
390 X 140 mm		976-12-390	976-26-390	976-40-390	976-54-390
390 X 190 mm		976-13-390	976-27-390	976-41-390	976-55-390
390 X 290 mm		976-14-390	976-28-390	976-42-390	976-56-390



**Schimmelbusch
976-57-140 To 976-112-390**



Ø	H				
140 X 140 mm		976-57-140	976-71-140	976-85-140	976-99-140
160 X 150 mm		976-58-160	976-72-160	976-86-160	976-100-160
190 X 160 mm		976-59-190	976-73-190	976-87-190	976-101-190
190 X 190 mm		976-60-190	976-74-190	976-88-190	976-102-190
240 X 120 mm		976-61-240	976-75-240	976-89-240	976-103-240
240 X 160 mm		976-62-240	976-76-240	976-90-240	976-104-240
240 X 240 mm		976-63-240	976-77-240	976-91-240	976-105-240
290 X 160 mm		976-64-290	976-78-290	976-92-290	976-106-290
290 X 240 mm		976-65-290	976-79-290	976-93-290	976-107-290
340 X 160 mm		976-66-340	976-80-340	976-94-340	976-108-340
340 X 240 mm		976-67-340	976-81-340	976-95-340	976-109-340
390 X 140 mm		976-68-390	976-82-390	976-96-390	976-110-390
390 X 190 mm		976-69-390	976-83-390	976-97-390	976-111-390
390 X 290 mm		976-70-390	976-84-390	976-98-390	976-112-390



Without partition

	L	B	H
977-01-15	15 X	15 X	15 mm
977-02-20	20 X	19 X	18 mm
977-03-30	30 X	30 X	15 mm
977-04-30	30 X	30 X	20 mm
977-05-30	30 X	30 X	30 mm
977-06-60	60 X	30 X	15 mm
977-07-60	60 X	30 X	20 mm
977-08-60	60 X	30 X	30 mm

Without partition

	L	B	H
977-09-275	275 X	275 X	130 mm
977-10-275	275 X	275 X	200 mm
977-11-275	275 X	275 X	260 mm
977-12-575	575 X	275 X	130 mm
977-13-575	575 X	275 X	260 mm
977-14-575	575 X	275 X	260 mm



With single partition

	L	B	H
977-15-275	275 X	275 X	130 mm
977-16-275	275 X	275 X	200 mm
977-17-275	275 X	275 X	260 mm
977-18-575	575 X	275 X	130 mm
977-19-575	575 X	275 X	260 mm
977-20-575	575 X	275 X	260 mm



With quarter partition

	L	B	H
977-21-275	275 X	275 X	130 mm
977-22-275	275 X	275 X	200 mm
977-23-275	275 X	275 X	260 mm
977-24-575	575 X	275 X	130 mm
977-25-575	575 X	275 X	260 mm
977-26-575	575 X	275 X	260 mm



	Ø	H
977-27-65	65 X	200
977-28-65	65 X	250
977-29-65	65 X	320
977-30-65	65 X	370
977-31-65	65 X	405
977-32-65	65 X	450
977-33-65	65 X	500

	Ø	H
977-34-65	65 X	380
977-35-65	65 X	420
977-36-65	65 X	450

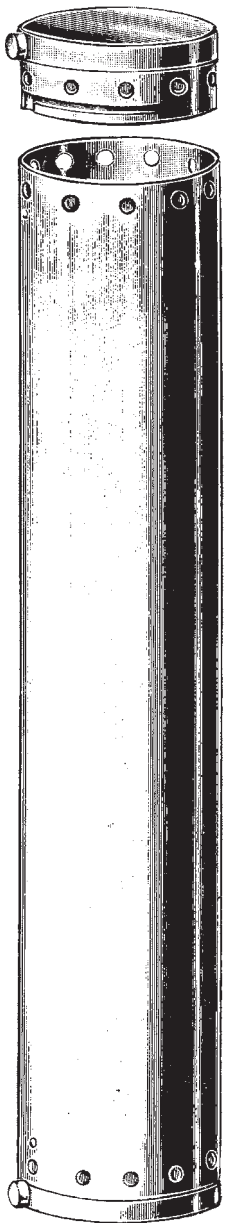

Alexander

	Ø	H
978-01-80	80	X 250 mm
978-02-80	80	X 320 mm
978-03-80	80	X 370 mm
978-04-80	80	X 430 mm
978-05-80	80	X 450 mm
978-06-80	80	X 500 mm
978-07-80	80	X 550 mm

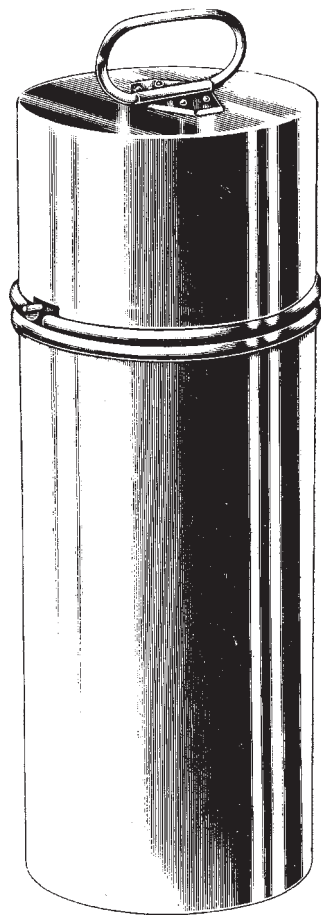

	Ø	H
978-08-125	125	X 310 mm
With rack		
978-09-125	125	X 310 mm
Without rack		



	Ø	H
978-10-120	120	X 250 mm
With rack		
978-11-120	120	X 250 mm
Without rack		

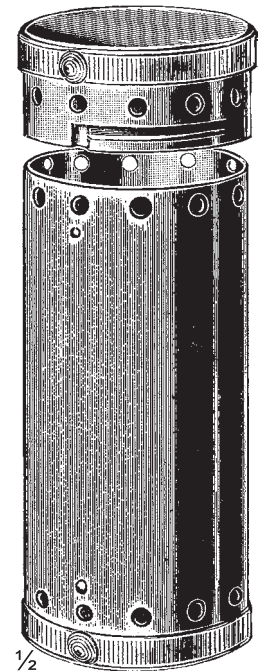
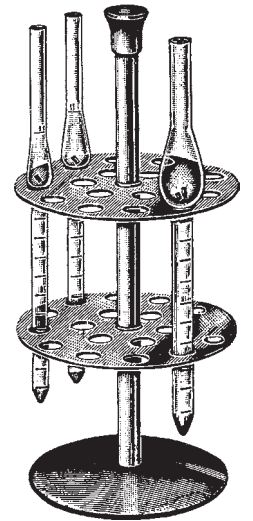

	Ø	H
978-12-60	60	X 140 mm
With rack		
978-13-60	60	X 140 mm
Without rack		



	L	B	H
979-01-275	275 X	275 X	70 mm
979-02-275	275 X	275 X	130 mm
979-03-275	275 X	275 X	260 mm
979-04-575	575 X	275 X	70 mm
979-05-575	575 X	275 X	130 mm
979-06-575	575 X	275 X	260 mm

Perforated lid and bottom



	L	B	H
979-07-275	275 X	275 X	70 mm
979-08-275	275 X	275 X	130 mm
979-09-275	275 X	275 X	260 mm
979-10-575	575 X	275 X	70 mm
979-11-575	575 X	275 X	130 mm
979-12-575	575 X	275 X	260 mm

Perforated lid and non-perforated bottom



	L	B	H
980-01-275	275 X	275 X	130 mm
980-02-275	275 X	275 X	260 mm
980-03-575	575 X	275 X	130 mm
980-04-575	575 X	275 X	260 mm

Non-perforated lid and bottom



	L	B	H
980-05-275	275 X	275 X	70 mm
980-06-275	275 X	275 X	130 mm
980-07-275	275 X	275 X	200 mm
980-08-275	275 X	275 X	260 mm
980-09-575	575 X	275 X	70 mm
980-10-575	575 X	275 X	130 mm
980-11-575	575 X	275 X	200 mm
980-12-575	575 X	275 X	260 mm

Perforated lid and bottom



Capacity in ltr.
981-01-01 1.0
981-02-01 1.5
981-03-02 2.0



Capacity in ltr.
981-04-01 1.0
981-05-01 1.5
981-06-02 2.0



Capacity in ltr.
981-07-01 100 X 165 mm 1.0
981-08-02 130 X 200 mm 2.0
981-09-03 155 X 220 mm 3.0
981-10-04 175 X 265 mm 5.0



Capacity in ltr.
981-11-05 0.5
981-12-01 1.0
981-13-02 2.0
981-14-03 3.0



With lid	Without lid	Lid Only
981-15-30	981-24-30	981-33-30
981-16-50	981-25-50	981-34-50
981-17-50	981-26-50	981-35-50
981-18-50	981-27-50	981-36-50
981-19-75	981-28-75	981-37-75
981-20-75	981-29-75	981-38-75
981-21-75	981-30-75	981-39-75
981-22-100	981-31-100	981-40-100
981-23-100	981-32-100	981-41-100

Lid only with triangle hole	Ø	H
981-42-30	30 X	90 mm
981-43-50	50 X	100 mm
981-44-50	50 X	130 mm
981-45-50	50 X	175 mm
981-46-75	75 X	100 mm
981-47-75	75 X	130 mm
981-48-75	75 X	175 mm
981-49-100	100 X	175 mm
981-50-100	100 X	200 mm



Lid with knob
981-51-30
981-52-75
981-53-75
981-54-100
981-55-100
981-56-100
981-57-125
981-58-135
981-59-135
981-60-135
981-61-150
981-62-150
981-63-200
981-64-200
981-65-240
981-66-240
981-67-290
981-68-290



Lid without knob	Ø	H
981-69-30	30 X	60 mm
981-70-75	75 X	75 mm
981-71-75	75 X	60 mm
981-72-100	100 X	100 mm
981-73-100	100 X	80 mm
98 1-74-100	125 X	125 mm
981-75-125	125 X	20 mm
981-76-135	135 X	35 mm
981-77-135	135 X	50 mm
981-78-135	135 X	100 mm
981-79-150	150 X	150 mm
981-80-150	150 X	100 mm
981-81-200	200 X	150 mm
981-82-200	200 X	200 mm
981-83-240	240 X	160 mm
981-84-240	240 X	230 mm
981-85-290	290 X	160 mm
981-86-290	290 X	240 mm



Satin finish	Mirror finish	Ø	H	Capacity Ltr
982-01-075	982-13-075	165 X	60 mm	0.75
982-02-01	982-14-01	170 X	70 mm	1.00
982-03-02	982-15-02	220 X	80 mm	2.00
982-04-02	982-16-02	225 X	90 mm	2.50
982-05-03	982-17-03	240 X	110 mm	3.00
982-06-04	982-18-04	255 X	115 mm	4.00
982-07-04	982-19-04	275 X	115 mm	4.50
982-08-06	982-20-06	290 X	125 mm	6.00
982-09-06	982-21-06	310 X	120 mm	6.00
982-10-08	982-22-08	345 X	125 mm	8.50
982-11-11	982-23-11	380 X	130 mm	11.00
982-12-14	982-24-14	415 X	140 mm	14.00

Satin finish	Mirror finish	Ø	H
982-25-330	982-27-330	330 X	90 mm
982-26-330	982-28-330	330 X	115 mm



982-29-110 Satin finish
982-30-110 Mirror finish
Ø 110 X 28 mm



Satin finish	Mirror finish	Ø	H	Capacity Ltr
982-31-05	982-38-05	40 X	19 mm	0.05
982-32-07	982-39-07	61 X	30 mm	0.07
982-33-035	982-40-035	116 X	50 mm	0.35
982-34-045	982-41-045	128 X	55 mm	0.45
982-35-070	982-42-070	147 X	65 mm	0.70
982-36-01	982-43-01	167 X	75 mm	1.10
982-37-01	982-44-01	187 X	85 mm	1.60



Satin finish	Mirror finish	Ø	H	Capacity Ltr
982-45-030	982-50-030	116 X	35 mm	0.30
982-46-040	982-50-040	128 X	38 mm	0.40
982-47-050	982-52-050	147 X	40 mm	0.50
982-48-075	982-53-075	157 X	45 mm	0.75
982-49-01	982-54-01	187 X	45 mm	1.00



With lid	Without lid	Ø	H	Capacity Ltr
983-01-020	983-03-020	110	27 mm	0.20
983-02-030	983-04-030	110	40 mm	0.30



	Ø	H	
983-05-100	100	20 mm	With lid
983-06-96	96	20 mm	Dish only
983-07-100	100	16 mm	Lid only



	Ø	H
983-08-96	96	20 mm
983-09-100	100	20 mm
983-10-100	100	16 mm
With lid		



983-11-00
Partition only
For 983-05-100 To 983-10-100



983-12-100
100 cc = 0.11



983-13-025	0.25 l
983-14-050	0.50 l
983-15-01	1.00 l
983-16-02	2.00 l



983-17-25
25 cc



983-18-50
50 cc



983-19-20
20 cc



983-20-75
Ø 75 X 12 mm



984-01-125
125 X 80 X 12 mm



	L	B	H
984-02-55	55	29	6 mm
984-03-75	75	29	6 mm
984-04-90	90	37	6 mm



	L	B	H
984-05-55	55	29	6 mm
984-06-75	75	29	6 mm
984-07-90	90	37	6 mm

Perforated bottom



	L	B	H
984-08-235	235	190	40 mm
984-09-330	330	230	30 mm
984-10-330	330	230	50 mm
984-11-350	350	250	30 mm
984-12-350	350	250	50 mm



	L	B	H
984-13-210	210	160	10 mm
984-14-240	240	180	10 mm
984-15-310	310	150	10 mm
984-16-310	310	210	10 mm
984-17-350	350	240	10 mm
984-18-400	400	270	20 mm
984-19-420	420	280	10 mm



984-20-250
250 X 115 X 15 mm



984-21-250
250 X 115 X 15 mm



984-22-250
250 X 115 X 15 mm



985-01-235
235 X 190 X 40 mm



985-02-220
Ø 220 X 70 mm



Krenn
985-03-193
193 X 163 X 13 mm



Krenn
985-04-193
193 X 163 X 13 mm



	L	B	H
985-05-200	200	150	50
985-06-225	225	150	50
985-07-250	250	200	50
985-08-275	275	175	50
985-09-300	300	200	50
985-10-300	300	250	50
985-11-350	350	250	50
985-12-375	375	300	50
985-13-450	450	300	50



985-14-200
200 X 75 X 40 mm



985-15-305
305 X 215 X 50 mm
Midwifery box



Without knob
986-01-165
986-02-200
986-03-200
986-04-230
986-05-260
986-06-270
986-07-300
986-08-325
986-09-325
986-10-420
986-11-420
986-12-575

With knob
986-13-165
986-14-200
986-15-200
986-16-230
986-17-260
986-18-270
986-19-300
986-20-325
986-21-325
986-22-420
986-23-420
986-24-575

With handle
986-25-165
986-26-200
986-27-200
986-28-230
986-29-260
986-30-270
986-31-300
986-32-325
986-33-325
986-34-420
986-35-420
986-36-575

With flat handle
986-37-165
986-38-200
986-39-200
986-40-230
986-41-260
986-42-270
986-43-300
986-44-325
986-45-325
986-46-420
986-47-420
986-48-575

L	B	H
165 X	85 X	35 mm
200 X	100 X	35 mm
200 X	100 X	35 mm
230 X	130 X	50 mm
260 X	150 X	50 mm
270 X	235 X	50 mm
300 X	200 X	50 mm
325 X	275 X	30 mm
325 X	275 X	50 mm
420 X	80 X	40 mm
420 X	175 X	50 mm
575 X	275 X	100 mm

986-49-205
 205 X 105 X 40 mm



986-50-100 Ø 100 mm
986-51-120 Ø 120 mm
986-52-150 Ø 150 mm



986-53-90
 Ø 90 X 90 mm



986-54-75
 Ø 75 X 50 mm



986-55-75
 Ø 75 X 80 mm



986-56-75
 Ø 75 X 80 mm



986-57-75
 Ø 75 X 80 mm



986-58-73
 Ø 73 X 75 mm



986-59-100
 Ø 100 X 50 mm



Tray with lid	Tray only	Lid only	Length
987-01-15	987-05-15	987-09-15	15 cm / 6"
987-02-20	987-06-20	987-10-20	20 cm / 8"
987-03-25	987-07-25	987-11-25	25 cm / 10"
987-04-30	987-08-30	987-12-30	30 cm / 12"



987-13-750
Male
Capacity 750 ml



987-14-750
Female
Capacity 750 ml



987-15-00



987-16-350
350 X 180 mm



987-17-00



987-18-387
387 X 156 mm
Slipper type with cover



988-01-00



988-02-312
312 x 362 mm
Perfection type with lid



988-03-00
With lid



988-04-220 With lid
988-05-220 Without lid
Ø 220 X 120 mm



988-06-340
Ø 340 mm



988-07-235 Ø 235 mm
988-08-310 Ø 310 mm
With lid



With cover	Without cover	Ø	H	Capacity ltr.
988-09-295	988-12-295	295	230	10
988-10-310	988-13-310	310	265	12
988-11-325	988-14-325	325	305	15

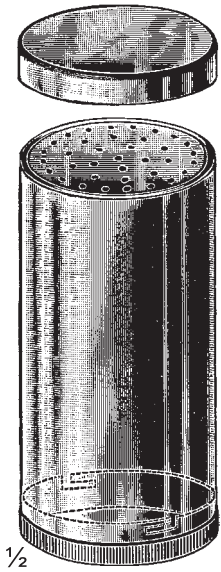

1/2
989-01-50
Ø 50 x 100 mm
With lid



1/2
989-02-75
Ø 75 x 90 mm
With lid



1/2
989-03-75 Ø 75 x 90 mm
989-04-100 Ø 100 x 130 mm
With lid

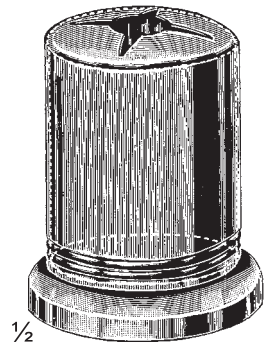

1/2
Methot
989-05-50
Ø 50 x 75 mm

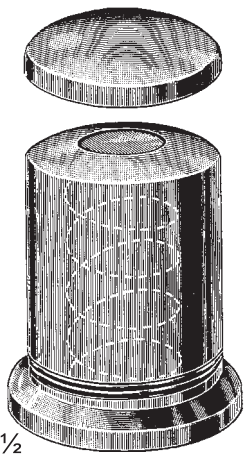

1/2
Methot
989-06-50 With lid
989-07-50 Without lid
Ø 50 x 75 mm

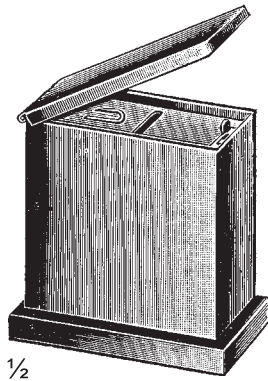

1/2
Luniatschek
989-08-60
60 X 60 X 30 mm



1/2
Phillip
989-09-75
Ø 75 X 115 mm
With lid



1/2
Phillip
989-10-75
Ø 75 X 100 mm
With insert



SURGICAL INSTRUMENT SETS

GENERAL SURGERY

BASIC LAPAROTOMY SET

<u>Quantity</u>	<u>Cat. Ref.</u>	<u>Description</u>
1 each	234-05	Yankauer Suction Tube
6 each	969-22	Mayo Forceps Holder, 20cm
2 each	20-01	Scalpel Handle No. 3
2 each	20-05	Scalpel Handle No. 4
1 each	21-04	Scalpel Handle No. 7
2 each	61-02	Mayo Operating Scissors, 17cm, Str
2 each	61-05	Mayo Operating Scissors, 17cm, Cur
1 each	70-07	Metzenbaum Scissors, 18cm, Cur
1 each	70-03	Metzenbaum Scissors, 23cm, Str, T/C
1 each	70-09	Metzenbaum Scissors, 23cm, Cur, T/C
2 each	129-03	Standard Dressing Forceps, 14cm
2 each	128-16	Tissue Forceps, 14cm, 1x2T
2 each	139-02	Hudson Tissue Forceps, 20cm, 1x2T
2 each	138-14	Russian Tissue Forceps, 20cm
6 each	162-01	Halstead Mosquito Forceps, 12.5cm, Str
6 each	162-05	Halstead Mosquito Forceps, 12.5cm, Cur
18 each	164-01	Kelly Forceps 14cm , Str
18 each	164-02	Kelly Forceps 14cm , Cur
6 each	168-03	Rochester-Pean Forceps, 16cm, Str
4 each	168-08	Rochester-Pean Forceps, 26cm, Str
4 each	175-07	Kocher-Ochsner Forceps, 25cm, Str, 1x2T
2 each	187-04	Mixer Forceps, 22cm
8 each	211-06	Backhaus Towel Forceps, 13cm
3 each	215-17	Foerster Sponge Forceps, 24cm, Str, Serr.
2 each	261-02	Mayo-Hegar Needle Holder, 18cm, T/C
1 each	261-03	Mayo-Hegar Needle Holder, 20cm, T/C
2 each	261-05	Mayo-Hegar Needle Holder, 26cm, T/C
1 each	234-01	Pool Suction Tube, Str
2 each	352-06	Goelet Retractor, 6mm Ø
1 each	377-05	Parker-Langenbeck Retractor, Set of 2
1 each	374-16	Retractor, 30mm
1 each	374-17	Retractor, 40mm
1 each	374-18	Retractor, 50mm
1 each	364-03	Deaver Retractor
1 each	364-04	Deaver Retractor
1 each	365-05	Deaver Retractor
1 each	347-01	Richardson Retractor, Small
1 each	347-02	Richardson Retractor, Medium
1 each	347-03	Richardson Retractor, Large
1 each	407-05	Balfour Retractor
4 each	188-07	Lahey Gall Duct Forceps, 19cm
4 each	767-07	Allis Tissue Forceps, 15cm, 4x5T
2 each	767-10	Allis Tissue Forceps, 25cm
4 each	769-06	Babcock Tissue Forceps, 16cm
2 each	769-08	Babcock Tissue Forceps, 24cm
4 each	177-10	Schmidt Tonsil Forceps, 19cm
2 each	842-02	De Bakey Tissue Forceps, 20cm

MINOR BASIC INSTRUMENT SET

<u>Quantity</u>	<u>Cat. Ref.</u>	<u>Description</u>
1 each	20-01	Scalpel Handle No. 3
1 each	20-05	Scalpel Handle No. 4
1 each	58-13	Operating Scissors, 14cm, Str, Sh/BI
1 each	61-02	Mayo Operating Scissors, 17cm, Str
1 each	70-07	Metzenbaum Scissors, 18cm, Cur
1 each	129-29	Tissue Forceps, 14cm, 1x2T
1 each	129-03	Standard Dressing Forceps, 14cm
4 each	162-01	Halstead Mosquito Forceps, 12.5cm, Str
4 each	162-05	Halstead Mosquito Forceps, 12.5cm, Cur
4 each	164-02	Kelly Forceps, Cur
6 each	211-06	Backhaus Towel Forceps, 13cm
2 each	215-17	Foerster Sponge Forceps, 24cm, Str, Serr.
2 each	261-02	Mayo Hegar Needle Holder, 18cm, T/C
2 each	259-04	Crile-Wood Needle Holder, 15cm, T/C
1 each	380-13	Cross Action Retractor, Blunt
2 each	308-13	Senn-Miller Retractor, Double Ended, Sharp
1 each	302-02	Crile Retractor, Double Ended
2 each	316-14	Volkman Retractor, 3 Prongs, Blunt
2 each	767-07	Allis Tissue Forceps, 15cm, 4x5T
1 each	235-05	Frazier-Fergusson Suction Tube, 10 Fr.

PLASTIC SET

<u>Quantity</u>	<u>Cat. Ref.</u>	<u>Description</u>
1 each	61-02	Mayo Operating Scissors, 17cm, Str
1 each	61-05	Mayo Operating Scissors, 17cm, Cur
1 each	65-05	Metzenbaum Scissors, 14cm, Cur
1 each	44-12	Iris Scissors, 14cm, Str, Sh/Sh
1 each	69-14	Ragnell Scissors, 12.5cm, Cur
2 each	129-02	Standard Dressing Forceps, 12.5cm
2 each	128-14	Tissue Forceps, 12.5cm, 1x2T
2 each	139-01	Hudson Dressing Forceps
2 each	139-02	Hudson Tissue Forceps, 1x2T
1 each	139-09	Adson-Brown Tissue Forceps
8 each	162-01	Halstead Mosquito Forceps, 12.5cm, Str
8 each	162-02	Halstead Mosquito Forceps, 12.5cm, Cur
6 each	164-02	Kelly Forceps, Cur
6 each	164-12	Rankin-Crile Forceps, 16cm, Cur
4 each	174-01	Kocher Forceps 5½", Str1x2T
2 each	166-06	Adson Haemostatic Forceps, 19cm, Cur
2 each	183-05	Gemini Forceps, 14cm
12 each	211-04	Backhaus Towel Clamp, 9cm
3 each	211-06	Backhaus Towel Clamp, 13cm
2 each	258-05	Webster Needle Holder, T/C
2 each	259-04	Crile-Wood Needle Holder, 15cm, T/C
1 each	381-06	Janson Retractor
2 each	308-13	Senn-Miller Retractor, Sharp
1 each	308-14	Senn-Miller Retractor, Blunt
1 each	377-05	Parker-Langenbeck Retractor, Set of 2
2 each	321-13	Murphy Retractor, 3 Prongs, Sharp
2 each	321-19	Murphy Retractor, 4 Prongs, Blunt
1 each	383-01	Weitlaner Retractor, 13cm, Blunt
6 each	767-07	Allis Tissue Forceps, 15cm, 4x5T
2 each	769-05	Baby-Babcock Forceps, 14cm
1 each	235-05	Frazier-Fergusson Suction Tube, 10 Fr
2 each	304-18	Joseph Skin Hook, Single
2 each	304-20	Joseph Skin Hook, Double 5 mm



SURGICAL INSTRUMENT SETS

GENERAL SURGERY

PEDIATRIC LAPAROTOMY SET (ADD PLASTIC SET)

Quantity	Cat. Ref.	Description
2 each	130-48	Tissue Forceps, 15cm, 4x5T
2 each	215-14	Foerster Sponge Forceps, 18cm, Serr.
2 each	379-17	Spring Wire Retractor
1 each	316-03	Baby-Farabeuf Retractor
1 each	374-10	Pediatric Retractor
2 each	366-10	Pediatric Deaver Retractor
2 each	347-01	Richardson Retractor
1 each	406-01	Pediatric Balfour Retractor
6 each	767-06	Baby-Allis Tissue Forceps, 14cm, 4x5T

APPENDECTOMY AND HERNIA SET

Quantity	Cat. Ref.	Description
2 each	20-01	Scalpel Handle No. 3
2 each	20-05	Scalpel Handle No. 4
1 each	61-02	Mayo Operating Scissors, 17cm, Str
1 each	61-05	Mayo Operating Scissors, 17cm, Cur
2 each	70-07	Metzenbaum Scissors, 18cm, Cur
2 each	129-03	Standard Dressing Forceps, 14cm
2 each	128-14	Tissue Forceps, 14cm, 1x2T
1 each	139-01	Hudson Dressing Forceps
2 each	139-02	Hudson Tissue Forceps, 1x2T
2 each	138-19	Russian Tissue Forceps, 20cm
2 each	162-01	Halstead Mosquito Forceps, 12.5cm, Str
12 each	164-09	Rankin-Crile Haemostatic Forceps 16cm Str
6 each	174-04	Kocher-Ochsner Forceps, 20cm, 1x2T, Str
12 each	211-06	Backhaus Towel Clamp, 13cm
3 each	215-16	Foerster Sponge Forceps, 23cm, Str, Serr.
2 each	261-02	Mayo Hegar Needle Holder, 23cm, T/C
1 each	234-01	Pool Suction Tube, Cur
1 each	234-03	Pool Suction Tube, Str
1 each	377-05	Parker-Langenbeck Retractor, Set of 2
1 each	374-16	Retractor
1 each	374-17	Retractor
1 each	375-05	Roux Retractor, Set of 3
2 each	347-04	Richardson Retractor
2 each	348-03	Kelly Retractor 2 1/2" x 2"
1 each	383-01	Weitlaner Retractor, 13cm
9 each	767-07	Allis Tissue Forceps 15cm, 4x5T
2 each	769-06	Babcock Tissue Forceps, 16cm

COMMON DUCT INSTRUMENTS (ADD LAPAROTOMY SET)

Quantity	Cat. Ref.	Description
2 each	183-11	Gemini Forceps, 28cm
1 each	857-12	Ochsner Gall Duct Probe
1 each	896-25	Bakes Duct Dilator, Set of 9
1 each	860-10	Fergusson Gall Scoop, Large
1 each	860-09	Fergusson Gall Scoop, Medium
1 each	860-08	Fergusson Gall Scoop, Small
2 each	188-08	Lahey Gall Duct Forceps, 23cm
1 each	864-01	Randall Stone Forceps, Fig. 1
1 each	864-02	Randall Stone Forceps, Fig. 2

COMMON DUCT INSTRUMENTS (cont'd)

1 each	864-03	Randall Stone Forceps, Fig. 3
1 each	864-04	Randall Stone Forceps, Fig. 4

BOWEL RESECTION SET (ADD BASIC LAPAROTOMY SET)

Quantity	Cat. Ref.	Description
12 each	162-05	Halstead Mosquito Forceps, 12.5cm, Cur
6 each	174-10	Rochester Carmalt Forceps 20cm, Str
3 each	768-05	Williams Tissue Forceps, 16.5cm
2 each	772-03	Allen Intestinal Forceps, 15cm, Str
2 each	773-09	Mayo-Robson Intestinal Forceps, 25cm, Str
2 each	773-02	Doyen Intestinal Forceps, 23cm, Str
2 each	773-05	Doyen Intestinal Forceps, 23cm, Cur
1 each	784-09	Stone Intestinal Clamp
1 each	780-01	Payr-Baby Intestinal Clamp, 14cm
2 each	780-03	Payr Intestinal Clamp, 15cm
2 each	780-07	Payr Intestinal Clamp, 27cm
2 each	780-09	Payr Intestinal Clamp, 33cm
2 each	842-02	De Bakey Tissue Forceps, 20cm

ABDOMINOPERINEAL RESECTION SET (ADD BASIC LAPAROTOMY SET AND BOWEL RESECTION SET)

Quantity	Cat. Ref.	Description
2 each	61-02	Mayo Operating Scissors, 17cm, Str
2 each	61-05	Mayo Operating Scissors, 17cm, Cur
2 each	61-12	Mayo Operating Scissors, 23cm, Cur
2 each	70-07	Metzenbaum Scissors, 23cm, Cur
1 each	141-09	Mayo-Russian Tissue Forceps, 23cm
2 each	141-07	Nelson-Tissue Forceps, 23cm
10 each	164-11	Rankin-Crile Forceps, 16cm, Str
6 each	164-12	Rankin-Crile Forceps, 16cm, Cur
2 each	168-14	Rochester -Pean Forceps, 20cm, Cur
6 each	174-04	Kocher-Ochsner Forceps, 20cm, Str
3 each	183-11	Gemini Forceps, 28cm
6 each	211-06	Backhaus Towel Forceps, 13cm
2 each	215-17	Foerster Sponge Forceps, 24cm, Str, Serr.
2 each	259-04	Crile-Wood Needle Holder, 15cm, T/C
1 each	264-04	Wangensteen Needle Holder, 26cm, T/C
1 each	322-01	Israel Retractor, 4 Prongs
1 each	322-03	Israel Retractor, 6 Prongs
2 each	316-15	Volkman Retractor, 4 Prongs, Blunt
12 each	767-07	Allis Tissue Forceps, 15cm, 4x5T
8 each	177-10	Schmidt Tonsil Forceps, 19cm



SURGICAL INSTRUMENT SETS

GENERAL SURGERY

THYROIDECTOMY SET (ADD PLASTIC SET)

<u>Quantity</u>	<u>Cat. Ref.</u>	<u>Description</u>
1 each	94-01	Metzenbaum Scissors, 18cm, Str, T/C
1 each	94-07	Metzenbaum Scissors, 18cm, Cur, T/C
2 each	130-48	Tissue Forceps, 15cm, 4x6T
6 each	166-02	Dixon-Lovelace Forceps, 16cm, Str, 1x2T
2 each	326-18	Lahey Retractor
2 each	301-09	Little Retractor, 17cm
2 each	298-17	Cushing Retractor, 23cm
6 each	879-03	Lahey Traction Forceps, 16cm

GENITO-URINARY SURGERY

NEPHRECTOMY SET

<u>Quantity</u>	<u>Cat. Ref.</u>	<u>Description</u>
2 each	61-02	Metzenbaum Scissors, 18cm
2 each	187-04	Mixer Forceps, 23cm
6 each	183-06	Mosquito Forceps, 21cm, Cur
6 each	183-09	Gemini Forceps, 23cm
4 each	183-11	Gemini Forceps, 28cm
1 each	244-02	Bozemann Forceps, 26cm, Double Cur
2 each	248-03	Heaney Needle Holder, 21cm
2 each	247-09	Sarot Needle Holder, 26cm
2 each	298-17	Cushing Retractor
1 each	232-11	Ochsner Trocar
1 each	189-06	Gray Gall Duct Forceps, 23cm
2 each	769-08	Babcock Tissue Forceps, 23.5cm
1 each	302-11	Love Retractor, Str
2 each	824-07	Satinsky-DeBaKey Forceps, 24cm
1 each	302-12	Love Retractor, 45°
1 each	864-01	Randall Stone Forceps, Fig. 1
1 each	864-02	Randall Stone Forceps, Fig. 2
1 each	864-03	Randall Stone Forceps, Fig. 3
1 each	864-04	Randall Stone Forceps, Fig. 4
2 each	190-08	Herrick Kidney Pedicle Clamp, 23cm
2 each	191-03	Mayo Guyon Clamp, 23cm

PYRLOPLASTY AND URETEROPLASTY SET (ADD BASIC LAPAROTOMY SET AND NEPHRECTOMY SET)

<u>Quantity</u>	<u>Cat. Ref.</u>	<u>Description</u>
1 each	44-04	Iris Scissors, 11.5cm, Str
1 each	139-01	Hudson Dressing Forceps
2 each	139-09	Adson-Brown Tissue Forceps
12 each	162-02	Halstead Mosquito Forceps, 12.5cm, Cur
1 each	258-05	Webster Needle Holder, 12cm, T/C
1 each	862-03	Mayo Gall Duct Scoop, 4mm
1 each	862-04	Mayo Gall Duct Scoop, 5mm
1 each	235-05	Frazier (Ferguson) Suction Tube 10 Fr.

SUPRAPUBIC AND RETROPUBIC PROSTATECTOMY SET (ADD BASIC LAPAROTOMY SET)

<u>Quantity</u>	<u>Cat. Ref.</u>	<u>Description</u>
1 each	61-02	Mayo Operating Scissors, 23cm, Str
1 each	61-05	Mayo Operating Scissors, 23cm, Cur
6 each	168-14	Rochester-Pean Forceps, 20cm, Cur
2 each	347-01	Richardson Retractor
2 each	348-03	Kelly Retractor
1 each	415-03	Judd-Masson Retractor
1 each	874-02	Van Buren Sound, Set of 6
2 each	869-02	Young Prostatic Retractor
1 each	871-05	Millin Capsule Holding Forceps, 23cm

VASECTOMY-MEATOTOMY SET

<u>Quantity</u>	<u>Cat. Ref.</u>	<u>Description</u>
1 each	21-01	Scalpel Handle No.3
1 each	61-02	Mayo Operating Scissors, 15cm, Str
1 each	61-05	Mayo Operating Scissors, 15cm, Cur
1 each	94-01	Metzenbaum Scissors, 18cm, Cur,T/C
1 each	129-03	Standard Dressing Forceps, 14cm
1 each	139-04	Adson Tissue Forceps, 12cm, 1x2T
6 each	162-01	Halstead Mosquito Forceps, 12.5cm, Str
6 each	162-02	Halstead Mosquito Forceps, 12.5cm, Cur
6 each	211-04	Backhaus Towel Forceps, 9cm
1 each	259-04	Crile-Wood Needle Holder, 15cm, T/C
1 each	767-07	Allis Tissue Forceps, 15cm

TUBOPLASTY SET (ADD BASIC LAPAROTOMY)

<u>Quantity</u>	<u>Cat. Ref.</u>	<u>Description</u>
1 each	21-04	Scalpel Handle No. 7
1 each	44-04	Iris Scissors, 11.5cm, Str
1 each	44-08	Iris Scissors, 11.5cm, Cur
2 each	139-09	Adson-Brown Tissue Forceps, 12cm
2 each	135-01	Potts Smith Dressing Forceps, 18cm, Serr.
8 each	162-02	Halstead Mosquito Forceps, 12.5cm, Cur
1 each	258-05	Webster Needle Holder, 12cm, T/C
2 each	155-07	Jewellers Style Forceps
2 each	303-13	Guthrie Hook, Double
1 each	720-19	Bowmann Probes, Set of 8
2 each	733-05	Castroviejo Forceps
1 each	741-08	McPherson-Vannas Scissors, 8cm, Str
1 each	271-04	Castroviejo Needle Holder, W/Lock
1 each	235-05	Frazier-Fergusson Suction Tube, 10 Fr.
2 each	303-17	Cottle Skin Hook



SURGICAL INSTRUMENT SETS

RECTAL SURGERY

RECTAL INSTRUMENT SET

Quantity	Cat. Ref.	Description
1 each	58-13	Operating Scissors, 14cm, Str, Sh/Bl
2 each	58-31	Mayo Operating Scissors, 15cm, Cur
1 each	61-02	Mayo Operating Scissors, 17cm, Str
1 each	61-05	Mayo Operating Scissors, 17cm, Cur
2 each	129-04	Standard Dressing Forceps, 16cm
2 each	129-30	Tissue Forceps, 15cm, 1x2T
8 each	164-09	Rankin-Crile Forceps, 16cm, Str
6 each	168-03	Rochester-Pean Forceps, 16cm, Cur
6 each	175-07	Kocher-Ochsner Forceps, 16cm, Cur, 1x2T
4 each	179-07	Pennington Forceps, 15cm
6 each	211-06	Backhaus Towel Forceps, 13cm
2 each	261-02	Mayo Hegar Needle Holder, 18cm, T/C
2 each	316-04	Volkman Retractor, 4 Prong, Sharp
4 each	767-09	Allis Tissue Forceps, 19cm, 5x6T
1 each	796-07	Sims Rectal Speculum
1 each	798-03	Hirschman Anoscope, Small
1 each	798-04	Hirschman Anoscope, Medium
1 each	798-05	Hirschman Anoscope, Large
1 each	795-01	Czerny Rectal Speculum, 22cm
1 each	803-10	Pratt Rectal Probe, 20cm
1 each	803-14	Rectal Hook, 24cm
1 each	807-10	Buie Suction Tube, 15 Fr.
1 each	805-07	Herget Biopsy Forceps

PILONIDAL CYST EXCISION SET (ADD RECTAL INSTRUMENT SET)

Quantity	Cat. Ref.	Description
1 each	316-15	Volkman Retractor, 4 Prong, Blunt
1 each	478-17	Spratt Bone Curette, 17cm, Fig. 3

HEMORRHOIDECTOMY SET

Quantity	Cat. Ref.	Description
1 each	20-01	Scalpel Handle No. 3
1 each	20-05	Scalpel Handle No. 4
1 each	61-02	Mayo Operating Scissors, 17cm, Str
1 each	61-05	Mayo Operating Scissors, 17cm, Cur
2 each	129-03	Standard Dressing Forceps, 14cm
2 each	129-29	Tissue Forceps, 14cm, 1x2T
6 each	162-01	Halstead Mosquito Forceps, 12.5cm, Str
4 each	174-01	Kocher Forceps, 14cm, 1x2T
6 each	168-03	Rochester Pean Forceps, 16cm, Cur
6 each	211-06	Backhaus Towel Forceps, 13cm
2 each	215-17	Foerster Sponge Forceps, 24cm, Str, Serr.
6 each	767-07	Allis Tissue Forceps, 16cm, 4x5T
1 each	798-04	Hirschman Anoscope, Medium
1 each	797-07	Brinkerhoff Rectal Speculum, Medium

OBSTETRICAL AND GYNECOLOGICAL SURGERY

DILATATION AND CURETTAGE SET

Quantity	Cat. Ref.	Description
1 each	20-01	Scalpel Handle No.3
1 each	20-06	Scalpel Handle No. 4L
1 each	129-06	Standard Dressing Forceps, 20cm
2 each	164-03	Rankin-Kelly Forceps, 16cm, Str
3 each	164-04	Rankin-Kelly Forceps, 16cm, Cur
4 each	211-06	Backhaus Towel Forceps, 13cm
2 each	215-17	Foerster Sponge Forceps, 24cm, Str, Serr.
2 each	244-02	Bozemann Dressing Forceps, 26cm
1 each	259-04	Crile-Wood Needle Holder, 15cm, T/C
3 each	767-07	Allis Tissue Forceps, 16cm, 4x5T
1 each	920-02	Graves Vaginal Speculum, Medium
1 each	927-01	Auvarud Weighted Speculum
1 each	931-09	Jackson Vaginal Retractor
1 each	931-10	Jackson Vaginal Retractor
1 each	931-11	Jackson Vaginal Retractor
1 each	904-14	Hegar Uterine Dilator, Set of 8
1 each	906-03	Goodell Uterine Dilator, 34cm
1 each	900-03	Sims Uterine Sound
2 each	882-01	Schroeder Tenaculum Forceps, 24cm, Str
1 each	885-05	Jacobs Vulsellum Forceps, 21.5cm, Str
1 each	914-02	Thomas Uterine Curette, Fig. 2, Blunt
1 each	914-04	Thomas Uterine Curette, Fig. 4, Blunt
1 each	914-06	Thomas Uterine Curette, Fig. 6, Blunt
1 each	911-37	Sims (Herrera) Uterine Biopsy Curette
1 each	887-02	Kelly Placenta Forceps, 32cm

BASIC VAGINAL INSTRUMENT SET

Quantity	Cat. Ref.	Description
1 each	20-01	Scalpel Handle No.3
1 each	20-05	Scalpel Handle No.4
1 each	20-06	Scalpel Handle No. 4L
1 each	58-13	Operating Scissors, 14cm, Str, Sh/Bl
1 each	61-02	Mayo Operating Scissors, 17cm, Str
1 each	61-05	Mayo Operating Scissors, 17cm, Cur
1 each	70-07	Metzenbaum Scissors, 18cm, Cur
2 each	129-03	Dressing Forceps, 14cm
1 each	129-06	Dressing Forceps, 20cm
2 each	129-29	Tissue Forceps, 14cm, 1x2T
2 each	129-32	Tissue Forceps, 20cm, 1x2T
6 each	164-02	Kelly Forceps, 14cm, Cur
6 each	164-01	Kelly Forceps, 14cm, Str
10 each	168-03	Rochester-Pean Forceps, 16cm, Cur
3 each	172-02	Kocher-Ochsner Forceps, 16cm, Str
8 each	211-06	Backhaus Towel Forceps, 13cm
6 each	215-17	Foerster Sponge Forceps, 24cm, Str, Serr.
1 each	244-02	Bozemann Dressing Forceps, 26cm
1 each	377-05	Parker-Langenbeck Retractor, Set of 2
1 each	364-03	Deaver Retractor
6 each	767-09	Allis Tissue Forceps, 19cm, 5x6T
1 each	927-01	Auvarud Weight Speculum
1 each	931-02	Sims Retractor, Medium
3 each	882-01	Schroeder Tenaculum Forceps, 24cm
1 each	882-04	Sken Vulsellum Forceps, 24cm, Cur

OBSTETRICAL AND GYNECOLOGICAL SURGERY

ABDOMINAL GYNECOLOGICAL SET (ADD BASIC LAPAROTOMY SET)

Quantity	Cat. Ref.	Description
1 each	20-06	Scalpel Handle No. 4L
1 each	61-05	Mayo Operating Scissors, 23cm, Cur
1 each	128-21	Tissue Forceps, 30cm, 1x2T
8 each	174-04	Kocher-Ochsner Forceps, 20cm, Str
3 each	215-16	Foerster Sponge Forceps, 23cm, Str, Serr.
2 each	248-03	Heaney Needle Holder, 20cm
1 each	409-13	O'Sullivan-O'Connor Retractor
6 each	767-09	Allis Tissue Forceps, 19cm, 5x6T
1 each	920-02	Graves Vaginal Speculum, Medium
2 each	882-01	Schroeder Tenaculum Forceps, 24cm
1 each	882-04	Sken Vulsellum Forceps, 24cm, Cur
2 each	885-06	Jacobs Vulsellum Forceps, Cur
2 each	885-05	Jacobs Vulsellum Forceps, Str
2 each	192-02	Heaney Hysterectomy Forceps, 21cm
2 each	193-03	Heaney-Ballantine Hysterectomy Forceps

LAPAROSCOPY SET

Quantity	Cat. Ref.	Description
1 each	20-01	Scalpel Handle No.3
1 each	61-02	Mayo Operating Scissors, 17cm, Str
1 each	139-02	Hudson Tissue Forceps, 1x2T
2 each	165-04	Coller Forceps, 16cm, Cur
12 each	211-06	Backhaus Towel Forceps, 13cm
2 each	215-16	Foerster Sponge Forceps, 23cm, Str, Serr.
1 each	243-03	Crile-Wood Needle Holder, 18cm
2 each	767-07	Allis Tissue Forceps, 16cm, 4x5T
1 each	920-02	Graves Vaginal Speculum, Medium
1 each	927-01	Auvar Weight Speculum
1 each	900-10	Simpson Uterine Sound
2 each	882-01	Schroeder Tenaculum Forceps, 24cm
2 each	878-04	Barrett Tenaculum Forceps, 19cm

BARTHOLIN CYST EXCISION SET

Quantity	Cat. Ref.	Description
1 each	20-01	Scalpel Handle No. 3
1 each	61-02	Mayo Operating Scissors, 17cm, Str
1 each	61-05	Mayo Operating Scissors, 17cm, Cur
1 each	70-07	Metzenbaum Scissors, 18cm, Cur
1 each	129-03	Dressing Forceps, 14cm
1 each	128-16	Tissue Forceps, 14cm, 1x2T
3 each	162-05	Halstead Mosquito Forceps, 12.5cm, Cur
3 each	168-03	Rochester Pean Forceps, 16cm, Cur
6 each	211-6	Backhaus Towel Forceps, 13cm
2 each	215-17	Foerster Sponge Forceps, 24cm, Str, Serr.
1 each	261-02	Mayo Hegar Needle Holder, 18cm, T/C
6 each	767-09	Allis Tissue Forceps, 19cm, 5x6T
1 each	927-01	Auvar Weight Speculum
1 each	931-02	Sims Vaginal Speculum, Double Ended

VAGINAL TUBAL LIGATION SET

Quantity	Cat. Ref.	Description
1 each	20-05	Scalpel Handle No. 4
1 each	20-06	Scalpel Handle No. 4L
1 each	61-02	Mayo Operating Scissors, 17cm, Str
1 each	91-03	Mayo Operating Scissors, 23cm, Str, T/C
1 each	91-06	Mayo Operating Scissors, 23cm, Cur, T/C
1 each	70-07	Metzenbaum Scissors, 18cm, Cur
1 each	128-16	Tissue Forceps, 14cm, 1x2T
2 each	138-20	Russian Tissue Forceps, 25cm
6 each	164-02	Kelly Forceps, 14cm, Cur
6 each	164-04	Rankin-Kelly Forceps, 16cm, Cur
2 each	168-14	Rochester-Pean Forceps, 20cm, Cur
2 each	183-11	Gemini Forceps, 28cm
6 each	211-06	Backhaus Towel Forceps, 13cm
3 each	215-17	Foerster Sponge Forceps, 24cm, Str, Serr.
2 each	248-03	Heaney Needle Holder, 20cm
1 each	364-04	Deaver Retractor
4 each	767-07	Allis Tissue Forceps, 15cm, 4x5T
2 each	767-09	Allis Tissue Forceps, 19cm, 5x6T
2 each	769-07	Babcock Tissue Forceps, 20cm
1 each	920-02	Graves Vaginal Speculum, Medium
1 each	927-01	Auvar Weight Speculum
1 each	900-10	Simpson Uterine Sound
2 each	882-01	Schroeder Tenaculum Forceps, 24cm
2 each	192-02	Heaney Hysterectomy Forceps, 21cm

NEUROSURGERY

BASIC CRANIOTOMY SET

Quantity	Cat. Ref.	Description
1 each	20-01	Scalpel Handle No. 3
1 each	20-05	Scalpel Handle No. 4
1 each	21-04	Scalpel Handle No. 7
1 each	61-02	Mayo Operating Scissors, 17cm, Cur
1 each	61-05	Mayo Operating Scissors, 17cm, Str
1 each	94-01	Metzenbaum Scissors, 18cm, Str, T/C
1 each	94-07	Metzenbaum Scissors, 18cm, Cur, T/C
1 each	72-03	Potts-Smith Scissors, 19cm, 25°
1 each	48-09	Kelly Scissors, 16cm
2 each	133-27	Semken Tissue Forceps, 15cm, 1x2T
2 each	139-03	Adson Dressing Forceps, 12cm, Serr.
2 each	139-04	Adson Dressing Forceps, 12cm, 1x2T
2 each	135-15	Cushing Tissue Forceps, 18cm, 1x2T
3 each	136-05	Taylor Bayonet Forceps, 18cm, Serr.
18 each	162-01	Halstead Mosquito Forceps, 12.5cm, Str
18 each	162-05	Halstead Mosquito Forceps, 12.5cm, Cur
24 each	162-18	Dandy Forceps, 14cm
6 each	174-02	Kocher-Ochsner Forceps, 16cm, Str
6 each	174-03	Kocher-Ochsner Forceps, 17cm, Str
3 each	166-03	Adson Forceps, 18.5cm, Str
3 each	166-04	Adson Forceps, 18.5cm, Cur
18 each	211-04	Backhaus Towel Forceps, 9cm
12 each	211-06	Backhaus Towel Forceps, 13cm



SURGICAL INSTRUMENT SETS

NEUROSURGERY

BASIC CRANIOTOMY SET (cont'd)

<u>Quantity</u>	<u>Cat. Ref.</u>	<u>Description</u>
6 each	215-17	Foerster Sponge Forceps, 24cm, Str, Serr.
4 each	259-04	Crile-Wood Needle Holder, 15cm, T/C
1 each	292-01	Michel Clip Applying Forceps
1 each	55-11	Wire Cutting Scissors, 12.5cm
1 each	381-06	Jansen Retractor, 11cm, Blunt
1 each	381-05	Wagner-Jansen Retractor, 12.5cm, Sharp
2 each	308-13	Senn-Miller Retractor, Double Ended, Sharp
2 each	321-19	Murphy Retractor, 19cm, 4 Prong, Sharp
2 each	390-01	Beckmann Retractor, 31cm, Sharp
1 each	384-05	Anderson-Adson Retractor, 20cm, Sharp
2 each	767-07	Allis Tissue Forceps, 15cm
1 each	627-15	Freer Elevator, 18cm, Double Ended
2 each	235-04	Frazier-Fergusson Suction Tube, 8 Fr.
2 each	235-05	Frazier-Fergusson Suction Tube, 10 Fr.
1 each	498-03	Zaufal-Jansen Bone Rongeur, 18cm
1 each	302-11	Love Retractor, 21.5cm, Str
1 each	501-02	Stille-Luer Bone Rongeur, 23cm, Angled
1 each	540-09	Hudson Hand Drill
2 each	754-15	Gigli Wire Saw Handle
2 each	754-11	Gigli Wire Saw, 50cm
1 each	755-01	Martel Gigli Saw Guide, 30cm
1 each	492-10	Luer Bone Rongeur, 18cm, Str
1 each	661-04	Schlesinger Rongeur, 15cm, 3mm Upwards
1 each	656-13	Ferris-Smith-Kerrison Rongeur, 18cm, 5mm
1 each	656-15	Ferris-Smith-Kerrison Rongeur, 18cm, 3mm
1 each	663-13	Cushing Pituitary Rongeur
1 each	763-06	Cushing Spoon, 17cm
1 each	757-01	Frazier Dura Dissector, 15cm
2 each	759-04	Frazier Dura Hook, 13cm, Sharp
1 each	759-08	Adson Dura Hook, 20cm
1 each	759-16	Dandy Hook, 21cm, Str
1 each	302-12	Love Retractor, 19cm, 45°
1 each	302-13	Love Retractor, 19cm, 90°
1 each	463-07	Lagenbeck Periosteal Elevator, 17cm
1 each	461-07	Adson Periosteal Elevator, 17cm
1 each	152-23	Adson Hypophyseal Bayonet Forceps 21.5cm

VENTRICULOGRAPHY SET

<u>Quantity</u>	<u>Cat. Ref.</u>	<u>Description</u>
2 each	20-01	Scalpel Handle No. 3
1 each	61-02	Mayo Operating Scissors, 17cm, Str
1 each	61-05	Mayo Operating Scissors, 17cm, Cur
1 each	70-07	Metzenbaum Scissors, 18cm, Cur
1 each	48-09	Kelly Scissors, 16cm, Str
1 each	133-27	Semken Tissue Forceps, 15cm, 1x2T
1 each	135-15	Cushing Tissue Forceps, 18cm, 1x2T
1 each	135-04	Cushing Tissue Forceps, 18cm, Serr.
6 each	162-18	Dandy Forceps, 14cm
6 each	211-04	Backhaus Towel Forceps, 9cm
4 each	211-06	Backhaus Towel Forceps, 13cm
4 each	215-17	Foerster Sponge Forceps, 24cm, Str, Serr.
1 each	259-04	Crile-Wood Needle Holder, 15cm, T/C
1 each	381-06	Jansen Retractor, 11cm, Blunt
1 each	381-05	Wagner-Jansen Retractor, 12.5cm, Sharp
1 each	308-13	Senn-Miller Retractor, Double Ended, Sharp
1 each	235-05	Frazier-Fergusson Suction Tube, 10 Fr.

VENTRICULOGRAPHY SET (cont'd)

<u>Quantity</u>	<u>Cat. Ref.</u>	<u>Description</u>
1 each	478-12	Spratt Bone Curette, 17cm, Fig. 000
1 each	478-14	Spratt Bone Curette, 17cm, Fig. 0
1 each	540-09	Hudson Hand Drill
1 each	759-04	Frazier Dura Hook, 12.5cm, Sharp
1 each	461-08	Adson Periosteal Elevator, 17cm, Cur

NEUROSURGICAL-LAMINECTOMY SET

<u>Quantity</u>	<u>Cat. Ref.</u>	<u>Description</u>
2 each	72-02	Potts-smith Scissors, 19cm, 45°
1 each	75-08	Strully Scissors, 20cm, With Probe Tips
2 each	139-03	Adson Dressing Forceps, 12cm, Serr.
2 each	139-04	Adson Tissue Forceps, 12cm, 1x2T
2 each	135-04	Cushing Dressing Forceps, 21cm, Bayonet
2 each	135-15	Cushing Tissue Forceps, 21cm, Bayonet
4 each	166-03	Adson Forceps, 21cm, Str
4 each	166-04	Adson Forceps, 21cm, Cur
6 each	215-17	Foerster Sponge Forceps, 23cm, Str, Serr.
2 each	261-14	Julian Needle Holder 20cm, T/C
1 each	754-03	McKenzie Clip Applying Forceps, 15cm
2 each	397-03	Gelpi Retractor, 18cm
1 each	526-03	Tuffier Retractor, 16.5cm
1 each	391-02	Beckmann-Adson Retractor, 31cm
1 each	478-11	Spratt Bone Curette, 17cm, Fig. 0000
1 each	478-13	Spratt Bone Curette, 17cm, Fig. 00
1 each	478-14	Spratt Bone Curette, 17cm, Fig. 0
1 each	302-11	Love Retractor, 19cm, Str
2 each	842-01	De Bakey Tissue Forceps, 16cm
1 each	540-06	Hudson Hand Drill
2 each	466-04	Taylor Bone Lever
2 each	466-05	Taylor Bone Lever
2 each	663-33	Spurling Rongeur, 15cm, Shaft, Upward
2 each	663-30	Spurling Rongeur, 15cm, Shaft, Str
2 each	655-18	Ferris-Smith-Kerrison Rongeur, 18 Shaft
2 each	663-20	Love-Gruenwald Rongeur, 12cm Shaft, Str
2 each	663-23	Love-Gruenwald Rongeur, 12cm Shaft
2 each	663-25	Love-Gruenwald Rongeur, 18cm Shaft
2 each	763-06	Cushing Spoon, 17cm
2 each	759-16	Dandy Nerve Hook, 21cm, Str
2 each	760-01	Smithwick Hook, 30cm, Double Ended
2 each	764-01	Scoville Nerve Root Retractor, Str
2 each	764-02	Scoville Nerve Root Retractor, Angular
1 each	461-08	Adson Periosteal Elevator, Cur
1 each	758-03	Penfield Dissector, Double Ended
1 each	390-02	Beckmann-Eaton Retractor, 32cm
1 each	436-19	Hoke Osteotome, 14cm
1 each	436-20	Hoke Osteotome, 14cm
1 each	436-21	Hoke Osteotome, 14cm
1 each	436-22	Hoke Osteotome, 14cm



SURGICAL INSTRUMENT SETS

NEUROSURGERY

SKULL TRACTION SET

Quantity	Cat. Ref.	Description
1 each	61-02	Mayo Operating Scissors, 17cm, Str
1 each	128-16	Tissue Forceps, 15cm, 1x2T
2 each	162-01	Halstead Mosquito Forceps, 12.5cm, Str
2 each	162-05	Halstead Mosquito Forceps, 12.5cm, Cur
8 each	211-04	Backhaus Towel Forceps, 9cm
2 each	215-17	Foerster Sponge Forceps, 23, Str, Serr.
1 each	538-13	Stille Pattern Cranial Drill
1 each	755-06	Crutchfield Skull Tracing Tongs

ORTHOPEDIC SURGERY

BASIC MAJOR ORTHOPEDIC SET

Quantity	Cat. Ref.	Description
1 each	20-01	Scalpel Handle No.3
2 each	20-05	Scalpel Handle No.4
2 each	61-01	Mayo Operating Scissors, 15cm, Str
2 each	61-04	Mayo Operating Scissors, 15cm, Cur
1 each	61-02	Mayo Operating Scissors, 17cm, Str
1 each	61-05	Mayo Operating Scissors, 17cm, Cur
1 each	70-07	Metzenbaum Scissors, 18cm, Cur
1 each	105-04	Lister Bandage Scissors, 20cm
2 each	128-16	Tissue Forceps, 15cm, 1x2T
2 each	130-51	Tissue Forceps, 15cm, 4x5T
2 each	139-03	Hudson Tissue Forceps, 12cm, 1x2T
10 each	164-09	Rankin-Crile Forceps, 16cm, Cur
6 each	174-04	Kocher-Ochsner Forceps, 20cm, Cur
10 each	211-06	Backhaus Towel Forceps, 13cm
2 each	261-03	Mayo Hegar Needle Holder, 15cm, T/C
2 each	259-04	Crile-Wood Needle Holder, 15cm, T/C
1 each	377-05	Parker-Langenbeck Retractor
2 each	339-01	Meyering Retractor, 21cm
2 each	339-02	Meyering Retractor, 23cm
2 each	322-01	Israel Retractor, 23cm, 4 Prong, Blunt
2 each	316-04	Volkman Retractor
2 each	316-15	Volkman Retractor
2 each	469-07	Benett Bone Lever
2 each	469-09	Benett Bone Lever
2 each	336-01	Hibbs Retractor, 24cm
1 each	390-01	Beckmann Retractor, 31cm
6 each	767-07	Allis Tissue Forceps, 15cm, 4x5T
1 each	235-04	Frazier-Fergusson Suction Tube, 10 Fr.
1 each	235-06	Frazier-Fergusson Suction Tube, 12 Fr.
1 each	498-02	Beyer Rongeur, 18cm, Cur
2 each	177-09	Schmidt Tonsil Forceps, 19cm
1 each	487-09	Ruskin-Liston Bone Cutting Forceps, 19cm
1 each	501-06	Stille-Luer Rongeur, 23cm, Cur
1 each	508-08	Kern-Lane Bone Holding Forceps, 27cm
1 each	511-02	Lambotte Bone Holding Forceps, 27cm
1 each	519-03	Lane Bone Holding Forceps, 33cm
1 each	516-04	Lowmann Bone Clamp, 18cm
1 each	516-05	Lowmann Bone Clamp, 20cm
2 each	316-01	Volkman Retractor, 22cm, Sharp
1 each	436-01	Hibbs Osteotome, 24cm, Str
1 each	436-02	Hibbs Osteotome, 24cm, Str

BASIC MAJOR ORTHOPEDIC SET (cont'd)

Quantity	Cat. Ref.	Description
1 each	436-03	Hibbs Osteotome, 24cm, Str
1 each	436-04	Hibbs Osteotome, 24cm, Str
1 each	437-06	Hibbs Gouge, 24cm, str
1 each	437-07	Hibbs Gouge, 24cm, str
1 each	437-08	Hibbs Gouge, 24cm, str
1 each	437-02	Hibbs Osteotome, 24cm, Cur
1 each	437-03	Hibbs Osteotome, 24cm, Cur
1 each	437-04	Hibbs Osteotome, 24cm, Cur
1 each	437-11	Hibbs Gouge, 24cm, Cur
1 each	437-12	Hibbs Gouge, 24cm, Cur
1 each	437-13	Hibbs Gouge, 24cm, Cur
1 each	423-04	Mallet, 26.5cm, 510g
1 each	458-17	Key Elevator, 19cm
1 each	458-18	Key Elevator, 19cm
1 each	458-19	Key Elevator, 19cm

THORACIC AND CARDIAC SURGERY

MAJOR CARDIOVASCULAR SET (ADD BASIC LAPAROTOMY SET)

Quantity	Cat. Ref.	Description
1 each	234-05	Yankauer Suction Tube
1 each	20-04	Scalpel Handle No. 3L
1 each	96-04	Metzenbaum Scissors, 18cm, Cur, T/C, S/S
1 each	94-09	Metzenbaum Scissors, 18cm, Cur, T/C, B/B
1 each	72-03	Potts-Smith Scissors, 19cm, 25°
1 each	72-02	Potts-Smith Scissors, 19cm, 45°
1 each	72-01	Potts-Smith Scissors, 19cm, 60°
1 each	72-03	Potts-Smith Scissors, 19cm, 25°, Delicate
2 each	159-13	Potts-Smith Dressing Forceps, 24cm, T/C
2 each	141-08	Nelson Tissue Forceps, 23cm, 5x6T
24 each	163-13	Providence Hospital Forceps, 14cm, Cur
18 each	164-06	Crile Forceps, 14cm, Cur
6 each	168-14	Rochester-Pean Forceps, 18cm, Cur
18 each	211-04	Backhaus Towel Forceps, 9cm
2 each	260-17	De Bakey Needle Holder, 23cm, T/C
2 each	301-19	Little Retractor, 17cm
1 each	298-17	Cushing Retractor, 23cm
1 each	374-16	Retractor, 30cm
4 each	374-17	Retractor, 40cm
2 each	364-03	Deaver Retractor
1 each	347-01	Richardson Retractor, Small
1 each	347-02	Richardson Retractor, Medium
1 each	348-02	Kelly Retractor
1 each	348-03	Kelly Retractor
1 each	343-02	Harrington Retractor, 30cm
1 each	343-01	Harrington Retractor, 30cm
2 each	316-04	Volkman Retractor 4 Prong, Sharp
1 each	627-15	Freer Elevator, 18cm, Double Ended
1 each	235-05	Frazier Suction Tube, 10 Fr
2 each	842-01	De Bakey Tissue Forceps, 16cm
2 each	842-03	De Bakey Tissue Forceps, 24cm
2 each	808-03	Glover Atrauma Bulldog Clamp, 9cm, Str



SURGICAL INSTRUMENT SETS

THORACIC AND CARDIAC SURGERY

MAJOR CARDIOVASCULAR SET (cont'd) (ADD BASIC LAPAROTOMY SET)

Quantity	Cat. Ref.	Description
2 each	808-07	Glover Atrauma Bulldog Clamp, 9cm, Cur
1 each	816-01	De Bakey-Semb Atrauma Forceps
2 each	814-03	De Bakey Atrauma Forceps, 31cm
2 each	819-02	De Bakey Atrauma Forceps, 21cm
2 each	819-03	De Bakey Atrauma Forceps, 25cm
1 each	824-04	De Bakey Atrauma Forceps, 26.5cm
2 each	182-08	Rumel Dissecting Forceps, 23cm
2 each	182-09	Rumel Dissecting Forceps, 23cm

CATARACT SURGEY SET (cont'd) (ADD BASIC EYE SET)

Quantity	Cat. Ref.	Description
1 each	730-10	Castroviejo Capsular Forceps, 10cm
1 each	741-15	Westcott Scissors, 11cm
1 each	742-03	Castroviejo Corneal Scissors, 11cm
1 each	742-02	Castroviejo Corneal Scissors, 11cm
1 each	268-11	Castroviejo Needle Holder, 14cm, Str

EAR, NOSE AND THROAT SURGERY

OPHTHALMIC SURGERY

BASIC EYE SET

Quantity	Cat. Ref.	Description
1 each	20-01	Scalpel Handle No. 3
1 each	21-04	Scalpel Handle No. 7
1 each	44-04	Iris Scissors, 11cm, Str
1 each	44-08	Iris Scissors, 11cm, Cur
4 each	162-01	Halsted Mosquito Forceps, 12.5cm, Str
6 each	162-05	Halsted Mosquito Forceps, 12.5cm, Cur
10 each	211-04	Backhaus Towel Forceps, 9cm
1 each	294-06	O'Brien Suture Scissors, 9cm
1 each	702-19	Lancaster Eye Speculum
1 each	702-15	Weiss Eye Speculum
1 each	704-12	Desmarres Lid Retractor
1 each	725-18	Graefe Iris Forceps, 10cm, Str
1 each	725-20	Graefe Iris Forceps, 10cm, Cur
1 each	725-24	Graefe Iris Forceps, 10cm, Str, 1x2T
1 each	725-26	Graefe Iris Forceps, 10cm, Cur, 1x2T
1 each	728-18	Graefe Fixation Forceps, 11cm
1 each	730-12	Arruga Capsular Forceps, 10cm
1 each	45-10	Stevens Scissors, 11.5cm, Cur
1 each	742-03	Castroviejo Corneal Scissors, 11cm
1 each	742-02	Castroviejo Corneal Scissors, 11cm
1 each	268-11	Castroviejo Needle Holder, 14cm, Str

BASIC EAR SET

Quantity	Cat. Ref.	Description
2 each	20-01	Scalpel Handle No. 3
1 each	61-05	Mayo Operating Scissors, 17cm, Cur
1 each	95-01	Metzenbaum Scissors, 14cm, Cur, T/C
1 each	94-09	Metzenbaum Scissors, 18cm, Cur, T/C
1 each	46-09	Scissors, 11.5cm, Str
1 each	46-10	Scissors, 11.5cm, Cur
1 each	139-04	Adson Tissue Forceps, 12cm, 1x2T
6 each	162-01	Halstead Mosquito Forceps, 12.5cm, Str
2 each	164-01	Kelly Forceps, 14cm, Str
8 each	211-04	Backhaus Towel Forceps, 9cm
1 each	258-04	Halsey Needle Holder, 12.5cm, T/C
1 each	55-11	Wire Cutting Scissors, 12.5cm
1 each	381-06	Jansen Retractor, 11cm, Blunt
1 each	380-16	Allport Retractor, 11cm, Sharp
2 each	308-13	Senn-Miller Retractor, Double Ended, Sharp
1 each	327-11	Langenbeck Retractor, 30x11mm
1 each	327-12	Langenbeck Retractor, 30x14mm
2 each	767-07	Allis Tissue Forceps, 15cm, 4x5T
1 each	728-18	Graefe Fixation Forceps
1 each	627-15	Freer Elevator, 18cm, Double Ended
1 each	681-15	Zoellner Ear Speculum, 5.5x6.5mm
1 each	681-16	Zoellner Ear Speculum, 6.5x7.5mm
1 each	681-17	Zoellner Ear Speculum, 7.5x8.5mm
1 each	681-18	Zoellner Ear Speculum, 8.5x9.5mm
1 each	696-09	Buck Ear Curette, Fig. 00, Str, Sharp
1 each	696-11	Buck Ear Curette, Fig. 1, Str, Sharp
1 each	142-02	Lucae Ear Forceps, 14cm
1 each	235-04	Frazier (Ferguson) Suction Tube, 8 Fr.
1 each	235-05	Frazier (Ferguson) Suction Tube, 10 Fr.
1 each	381-10	Henner (Lempert) Retractor, 12cm
2 each	304-18	Joseph Skin Hook, Single

CATARACT SURGEY SET (ADD BASIC EYE SET)

Quantity	Cat. Ref.	Description
1 each	703-14	Park Eye Speculum
1 each	24-02	Troutman Blade Breaker
1 each	712-06	Graefe Hook, 14cm
1 each	715-05	Lewis Lens Scoop, 14cm
1 each	714-04	Wecker Iris Spatula, 13cm
1 each	716-11	Kirby Hook and Expressor, 14cm
1 each	727-10	Barraquer-Katzin Iris Forceps, 7cm
1 each	729-04	O'Brien Fixation Forceps, 11cm, 1x2T
1 each	727-15	Castroviejo Iris Forceps, 9cm, Str
1 each	727-16	Castroviejo Iris Forceps, 9cm, Cur



SURGICAL INSTRUMENT SETS

EAR, NOSE AND THROAT SURGERY

BASIC NASAL SET

<u>Quantity</u>	<u>Cat. Ref.</u>	<u>Description</u>
1 each	234-05	Yankauer Suction Tube
1 each	20-01	Scalpel Hndle No. 3
1 each	21-04	Scalpel Hndle No. 7
1 each	61-02	Mayo Operating Scissors, 17cm, Cur
2 each	44-14	Iris Scissors, 11.5cm, Cur
1 each	65-05	Metzenbaum Scissors, 14cm, Cur
2 each	70-07	Metzenbaum Scissors, 18cm, Cur
2 each	139-04	Adson Tissue Forceps, 12cm, 1x2T
6 each	162-01	Halstead Mosquito Forceps, 12.5cm, Str
6 each	162-02	Halstead Mosquito Forceps, 12.5cm, Cur
6 each	211-04	Backhaus Towel Forceps, 9cm
1 each	258-04	Halsey Needle Holder, 12.5cm, T/C
1 each	381-06	Jansen Retractor, 11cm
1 each	386-06	Allport Retractor, 10.5cm
1 each	308-13	Senn-Miller Retractor, Double Ended, Sharp
1 each	308-14	Senn-Miller Retractor, Double Ended, Blunt
1 each	377-05	Parker-Langenbeck Retractor
2 each	767-07	Allis Tissue Forceps, 15cm, 4x5T
1 each	728-18	Graefe Forceps
2 each	235-04	Frazier (Fergusson) Suction Tube, 8 Fr.
1 each	422-01	Mallet, 18.5cm, 200g
1 each	614-02	Viena Nasal Speculum, Fig. 2
1 each	615-12	Killian Nasal Speculum, 90mm
1 each	615-13	Cottle Nasal Speculum, 50 mm
1 each	143-04	Troeltsch (Wilde) Dressing Forceps, 17cm
2 each	304-18	Joseph Skin Hook, Single
2 each	304-19	Joseph Skin Hook, Double, 2mm
2 each	304-21	Joseph Skin Hook, Double, 7mm

MINOR NASAL SET

<u>Quantity</u>	<u>Cat. Ref.</u>	<u>Description</u>
1 each	234-05	Yankauer Suction Tube
1 each	655-27	Kerrison Rongeur, 4x3mm
1 each	422-01	Mallet, 18.5cm, 200g
1 each	614-02	Viena Nasal Speculum, Fig. 2
1 each	615-12	Killian Nasal Speculum, 90mm
1 each	615-13	Cottle Nasal Speculum, 50mm
1 each	620-10	Noyes Polypus Forceps, 16.5cm
1 each	622-04	Takahashi Polypus Forceps, 19cm, 2x10mm
1 each	642-03	Ash Forceps, 22cm

MAJOR NASAL SET (ADD BASIC NASAL SET)

<u>Quantity</u>	<u>Cat. Ref.</u>	<u>Description</u>
1 each	44-04	Iris Scissors, 11cm, Str
1 each	46-09	Scissors, 11cm, Str
1 each	46-10	Scissors, 11cm, Cur
2 each	142-06	Gruenwald (Jansen) Dressing Forceps, 16cm
1 each	259-04	Crile-Wood Neelde Holder, 15cm, T/C
1 each	299-13	Cottle Retractor
1 each	627-15	Freer Elevator, 18cm, Double Ended
1 each	619-01	Hartmann Nasal Polypus Forceps, 16cm
1 each	618-06	Jackson Nasal Scissors, 22cm
1 each	627-01	Ballenger Septum Knife, 3mm, Str
1 each	625-06	Converse Septum Knife
1 each	625-04	Fomon Knife, 16cm, Double Ended, Cur
1 each	625-01	Cottle Nasal Knife, 15cm
1 each	628-05	Joseph Elevator, 16cm, Cur
1 each	304-15	Gillies Hook, 18cm
1 each	303-16	Cottle Double Hook, 16cm
1 each	637-07	Fomon Retractor, Ball End Prongs
1 each	637-03	Cottle Retractor, 14cm
1 each	304-18	Joseph Skin Hook, Single
2 each	304-20	Joseph Skin Hook, Double, 5mm
1 each	637-13	Masing Retractor, 20cm, Double Ended
1 each	438-02	Sheehan Osteotome, 16cm, 4mm
1 each	438-04	Sheehan Osteotome, 16cm, 8mm
1 each	438-05	Sheehan Osteotome, 16cm, 10mm
1 each	438-06	Sheehan Osteotome, 16cm, 12mm
1 each	634-3	Cottle Septum Chisel, 4mm, Cur
1 each	644-04	Cottle Forceps, 11cm
1 each	646-03	Fomon Nasal Scissors, 12.5cm, Cur
1 each	646-01	Fomon Nasal Scissors, 13cm, Angular

	Page		Page
A			
Abadie Intestinal and Stomach Clamp Forceps	783	Adson-Baby Retractor	385
Abadie Ophthalmic Curettes	710	Adson-Brown Tissue Forceps	139, 140
Abdominal Retractors	404-414	Adson-Brown Tissue Forceps with T/C	158
" Badgley	407	Adson-Graefe Tissue Forceps	140
" Balfour	406, 407	Aebli Ophthalmic Micro Scissors	739
" Balfour-Baby	406	Aesthesiometers	11
" Center Blade for Balfour	407	" Aly	11
" Cherry	407	" Wartenberg	11
" Denis-Browne	412	" Weber	11
" Doyen	414	Agricola Eye Speculum	703
" Franz	411	Agricola Retractor	379
" Frazier	410	Alabama-University Ophthalmic Suture Forceps	732
" Gosset	408	Albarran Reverdin Needles	277
" Hertzler	406	Albarran Retractor	357
" Houzal	404	Alderdyce Tonsil Elevators	592
" Kirschner	410	Alderdyce Elevators	463
" Kirschner (Semm)	412	Alexander Bone Chisels	439
" Oettingen	404	Alexander Bone Gouges	439
" O-Sullivan-O'Conner	409	Alexander Bone Rongeurs	493
" Perman	405	Alexander Raspatories	455
" Quervain	405	Alexander Sterilizing Jars	978
" Robin-Masse	404	Alexander Tonsil Needles	594
" Rochard	414	Alexander Uterine Biopsy Forceps	891
" Scoville-Richter	409	Allen Intestinal Clamp Forceps	772
" Temple Fay	410	Allen-Kocher Haemostatic Forceps	170
" Ulrich-St. Gallen □	409	Allis Atrauma Tissue and Organ Holding Forceps	770
Abel Uterine Tenaculum Forceps	881	Allis Lung Grasping Forceps	537
Abortion Scoops	952	Allis Tissue and Organ Holding Forceps	767
Abraham Tonsil Knives	587, 588	Allis-Adair Tissue and Organ Holding Forceps	767
Abscess Knives	34	Allis-Babcock Tissue and Organ Holding Forceps	769
" Dieffenbach	34	Allis-Baby Tissue and Organ Holding Forceps	767
" Sven Hanssen	34	Allis-Niro Tissue and Organ Holding Forceps	768
" Vaughan	34	Allison Retractor	370
Accessories for Stethoscopes	9	Allison Spatulas	370
Adair Uterine Tenaculum Forceps	878	Allport Hooklets	698
Adams Operating Scalpel	32	Allport Retractor	380
Adenoid Curettes	648-652	Alm Retractor	380
" Barnhill	651	Alu Tuning Forks	685, 687
" Ingersoll	649	Alvis Ophthalmic Curettes	710
" La Force	650	Aly Aesthesiometer	11
" La Force-Stevenson	650	Amann Gauze Packers	901
" Meddleton	649	Amenabar Lid Expressor	704
" Moure	651	Amenabar Ophthalmic Lens Expressor	715
" Shambaugh	650	Amputation Knives	41, 42
" Shambaugh (Negus)	652	" Catlin	41
" St. Clair-Thomson	649	" Collin	41, 42
" Stubbs	651	" Langenbeck	42
" Vogel	649	" Liston	41
Adlerkreutz Tissue Forceps	136	" Simon	42
Adson Bone Rongeurs	496	Amputation Saws	116-119
Adson Dressing Forceps	139, 140	" Barker	117
Adson Dressing Forceps with T/C	158	" Bier	118
Adson Dura Hooks	759	" Bruns	119
Adson Elevators	461	" Butcher	117
Adson Haemostatic Forceps	166	" Charriere	116
Adson Hypophyseal Forceps	152	" Collin	117
Adson Instrument for Cranial Opening	755	" Detachable	116
Adson Needle Holders	243	" Gigli	119
Adson Raspatories	457	" Helferich-Bier	118
Adson Reamer Forceps	540	" Hinged Back	116
Adson Retractor	305, 386, 387, 389, 390	" Lindemann	119
Adson Suction Tubes	235	" Olivecrona	119
Adson Tissue Forceps	139, 140	" Rust	118
Adson Tissue Forceps with T/C	158	" Satterlee	116
		" Weiss	116

	Page		Page
Anaesthesia Masks	15	" Cooley	832-835
" Baby-Esmarch	15	" Cooley-Glassman	836
" Esmarch	15	" Dale	830
" Julliard	15	" Dardik	831
" Schimmelbusch	15	" De Bakey	811-819
" Yankauer	15	" De Bakey-Beck	820
Anal Retractors	797, 798	" De Bakey-Harken	827
Anatomy Knives	36-40	" De Bakey-McQuigg-Mixter	818
Anderson Obstetrical Forceps	962	" De Bakey-Mixter	817
Anderson-Adson Retractor	384	" De Bakey-Rumel	817
Anderson-Critchett Ophthalmic Knives	709	" De Bakey-Semb	816
Anderson-Neivert Rhinoplastic Chisel	636	" Derra	830
Andrew Tongue Depressors	571	" Derra-Cooley	832
Andrews-Pynchon Suction Tubes	234	" Dick	837
Anestophon Stethoscope	8	" Dietrich	829
Angiotribes Buie	180	" Glover	821
Angiotribes Fergusson	180	" Glover-De Bakey	825
Angle Wire Cutting Pliers	552	" Gregory	829
Ankeney Rib Spreaders	533	" Henly	830
Anoscopes	798, 799	" Lambert-Kay	825
Antoli-Candela Ear Curettes	697	" Lambert-Kay Modif.	825
Aorta Clamps	849	" Lees	826
" Blalock	849	" Leland-Jones	827
" Pott (Johns-Hopkins)	849	" Morris-De Bakey	820
" Potts-Smith	849	" Ochsner	829
Aorta Retractors Cooley	850	" Parry-Cooley	834
Aortic Bioptome	844	" Potts	821, 822
" Brock	844	" Rein	828
" Schulz	844	" Satinsky	824
Aortic Dilators	844	" Satinsky-De Bakey	824
Appendorf Uterine Biopsy Forceps	895, 898	" Weber	828
Arrowsmith Ophthalmic Radial Keratomy Forceps	737	" Werthiem	837
Arruga Eye Speculum	703	Atrauma Forceps Hysterectomy and Vaginal	201-203
Arruga Micro Needle Holders	269, 272	" Dick	202
Arruga Needle Holders with T/C	267	" Werthiem	202, 203
Arruga Ophthalmic Capsular Forceps	730	" Roger	201
Arruga Ophthalmic Hooklets	712	Atrauma Forceps Kidney Pedicle Clamps	201, 868
Arruga Ophthalmic Retractors	713	" Werthiem	868
Arruga Ophthalmic Trephines	721	" Guyon	201
Arruga-Nizetic Ophthalmic Capsular Forceps	730	Atrauma Forceps Prostatectomy Millin	871
Art Ophthalmic Scoops	715	Atrauma Forceps Ureter	872
Artery Forceps	172, 173	Atrauma Forceps Uro-Tangential	203
Arthur Splinter Forceps	148	Atrauma Forceps Uterine Polypus and Ovum	888
Asch Biopsy Curettes	907	Atrauma Haemorrhoidal Forceps	801
Asch Rhinoplastic Forceps	642	Atrauma Haemostatic Forceps	809, 810
Asch Secretion Curettes	876	" De Bakey-Bainbridge	810
Aspiration Curettes	917	" De Bakey-Kelly	809
Assistant Standard Pocket Instrument Set	295	" De Bakey-Kelly-Rankin	809
Atlee Atrauma Cardiovascular Forceps	825	" De Bakey-Mosquito	809
Atrauma Anastomosis Forceps Dick	789	" De Bakey-Pean	810
Atrauma Aorta Clamps	841	Atrauma Intestinal and Stomach Clamp Forceps	785-789
" Hume	841	" Forceps Doyen	785
" Pappen-Blalock	841	" Forceps Glassman	788
" Schumaker	841	" Forceps Habere	789
Atrauma Biopsy Forceps for Rectum	804	" Forceps Hartmann	787
Atrauma Bulldog Clamps	808, 809	" Forceps Kocher	786
" De Bakey	808, 809	" Forceps Mayo-Robson	787
" De Bakey-Carotis	809	" Forceps Scudder	787
" De Bakey-Satinsky	809	Atrauma Intestinal Clamp Forceps	793, 794
" Glover	808	" Brunner	793
" Gregory-Soft	809	" Kersting	794
Atrauma Cardiovascular Forceps	811-837	Atrauma Sigmoid Anastomosis Forceps	790-793
" Atlee	825	" De Bakey (Morris Modif.)	793
" Castaneda	826	" Fehland	792
" Castaneda	829	" Glassman	790

	Page		Page
Atrauma Sigmoid Anastomosis Forceps (cont'd)			
" Heyes	790	Baginsky Tongue Depressors	571
" Kersting	791	Baginsky Tonsillectomes	598
" Morris	793	Bailey Rib Spreaders and Contractors	535
" Resano	792	Bailey-Baby Rib Spreaders and Contractors	535
" Veidenheimer	791	Bailey-Glover-O'Neil Valvulotomes	851
Atrauma Tissue and Organ Holding Forceps	770	Bailey-Williamson Obstetrical Forceps	961
" Allis	770	Bainbridge Haemostatic Forceps	170
" Collin	770	Bainbridge-Baby Haemostatic Forceps	170
" Glassman-Allis	770	Bainbridge-Glassman Haemostatic Forceps	169
" Glassman-Babcock	770	Bainbridge Intestinal Clamp Forceps	772
Atrauma Tissue Forceps	842, 843	Bakes Gall Duct Dilators	863
" Cooley	843	Balfour Abdominal Retractor	406, 407
" De Bakey	842	Balfour-Baby Abdominal Retractor	406
" Glassman	843	Ballenger Nasal Knives	626
Aubaret Ophthalmic Retractors	713	Ballenger Septum Knives	627
Aufricht Bone Files	474	Ballenger Tonsil Seizing Forceps	594
Aufricht Rhinoplastic Files	639	Ballentine Hysterectomy Forceps	193
Aufricht Rhinoplastic Retractors	638	Band Moving Curettes Scoville	761
Aufricht Rhinoplastic Scissors	646	Bandage Roller	107
Aufranc Bone Levers	472	Bandage Scissors	104-107
Automatic Cilia Forceps	150	Bandage Scissors with T/C	103
Auward Basiotribes	957	Bane Bone Rongeurs	496
Auward Vaginal Speculum	927	Barbara Ear Hooks	693
Auward-Zweifel Basiotribes	957	Barbara Ear Needles	693
Awls	586	Barbara Ear Picks	693
" Kelsey-Fry	586	Barens Cranioclast	956
" Obwegesser	586	Barens Micro Needle Holders	269
" Sanders-Brown	586	Barens Obstetrical Forceps	962
Axenfeld Eye Speculum	703	Barens Ophthalmic Advancement Forceps	736
Axenfeld Ophthalmic Dissectors	718	Barens Ophthalmic Keratomes	707
Axenfeld Ophthalmic Knives	709	Barens Ophthalmic Knives	707
Axenfeld Ophthalmic Retractors	713	Barens Ophthalmic Lens Expressors	713
Axhausen Needle Holders	250	Barens Suturing Spatula	705
Ayre Chalazion Forceps	737	Barkan Ophthalmic Knives	709
Ayre Cone Knives	35, 902	Barker Amputation Saws	117
B		Barnes-Neville Obstetrical Forceps	964
B. P. Handles	20-23	Barnhill Adenoid Curettes	651
Babcock Lung Grasping Forceps	537	Barr Rectal Specula	797
Babcock Tissue and Organ Holding Forceps	769	Barraquer (Colibri) Eye Speculum	702
Babcock Tissue and Organ Holding Forceps with T/C	770	Barraquer (Colibri) Ophthalmic Fixation Forceps	727
Babcock-Baby Tissue and Organ Holding Forceps	769	Barraquer Micro Needle Holders	269, 270
Babere Intestinal and Stomach Clamp Forceps	782	Barraquer Modif. Ophthalmic Strabismus Forceps	733
Babinski Percussion Hammer	16	Barraquer Ophthalmic Anterior Chamber Forceps	735
Baby-Adson Dissecting and Ligature Forceps	181	Barraquer Ophthalmic Capsular Forceps	731
Baby-Collin Retractor	401	Barraquer Ophthalmic Fixation Forceps	728
Baby-Crile Haemostatic Forceps	164	Barraquer Ophthalmic Knives	706, 709
Baby-Crile-Wood Needle Holders with T/C	259	Barraquer Ophthalmic Micro Scissors	738
Baby-Esmarch Anaesthesia Mask	15	Barraquer Retractor	379
Baby-Kocher Intestinal Clamp Forceps	772	Barraquer-Katzin (Colibri) Ophthalmic Fixation Forceps	727
Baby-Mikulicz Peritoneal Clamp Forceps	204	Barraquer-Katzin Ophthalmic Fixation Forceps	727
Baby-Mixer Dissecting and Ligature Forceps	184	Barraquer-Llovera Ophthalmic Fixation Forceps	728
Baby-Overholt Haemostatic Forceps	171	Barraquer-Troutman Micro Needle Holders	270
Baby-Roux Retractor	375	Barsky Retractor	306
Baby-Satinsky Vena Cava Clamps	852	Barth Bone Curettes	476
Baby-Senn-Miller Retractor	308	Barton Obstetrical Forceps	962
Baby-Tischler Uterine Biopsy Forceps	898	Basin Triangular	987, 988
Backhaus Towel Forceps	211	Basiotribes	957
Backhaus-Kocher Towel Forceps	211	" Auward	957
Backmann-Eaton Retractor	390	" Auward-Zweifel	957
Bacon Bone Rongeurs	494	" Tarnier	957
Badgley Abdominal Retractor	407	Battery Handles for Diagnostic Sets	12
Baer Rib Shears	522	Baxt Laryngeal Mirrors	581
		Beacham Uterine Tenaculum Forceps	882
		Beaupre Cilia Forceps	150
		Becker Oesophagus Dissectors	794

TABLE OF CONTENTS

	Page		Page
Beckmann Adenoid Curettes	648	Biopsy Forceps for Rectum (cont'd)	
Beckmann Nasal Speculum	614	" Jackson	805
Beckmann Retractor	390	" Yeoman	804
Beckmann-Adson Retractor	391	Biopsy Uterine Forceps	891-898
Beckmann-Bayonet Retractor	392	" Alexander	891
Bed Pan	988	" Appendorf	895, 898
Beebee Ligature Scissors	55	" Baby-Tischler	898
Beer Cilia Forceps	150	" Burke	897, 898
Beer Ophthalmic Knives	706	" Douay	896
Beeson Plaster Spreaders	113	" Faure	894
Bellocq Cannula	653	" Gaylor	893
Bellucci Ear Polypus Forceps	672	" Gellhorn	893
Bellucci Micro Ear Scissors	676, 677	" Kevorkian	893, 898
Bellucci Retractor	384	" Kevorkian-Pacific	897, 898
Bengolea Haemostatic Forceps	167	" Krause	896
Bennet Bone Levers	469	" Medina	894
Bennet Cilia Forceps	149	" Mini-Townsend	898
Bensaude Rectal Specula	798	" Scheinmann	896
Benson Intestinal and Stomach Clamp Forceps	783	" Schubert	891, 892
Berens Lid Everters	704	" Schumacher	892, 895, 896
Berens Ophthalmic Hooks	712	" Schumacher-Van Doren	892
Berens Ophthalmic Knives	706	" Seidl	894
Berens Ophthalmic Muscular Clamp	735	" Swiss Mod.	896
Berens Transplant Forceps	721	" Thoms-Gaylor	893
Bergh Cilia Forceps	149	" Tischler	894, 897, 898
Bergmann (Hibbs) Mallet	421	" Tischler-Kevorkian	897, 898
Bergmann Bandage Scissors	106	" Tischler-Morgan	897, 898
Bergmann Bone Osteotomes	441	" Van Doren	892, 893
Bergmann Mallet	421	" Wittner	895
Bergmann Operating Scalpel	30	Bioptome Aortic	844
Bergmann Retractor	303	" Brock	844
Bergmann Saw	115	" Schulz	844
Bergmann-Foerster Dressing and Sponge Holding Forceps	220	Bircher Meniscectomy Forceps	428
Bergstroem Gall Duct Forceps	857	Bircher Meniscectomy Knives	426
Berke Ophthalmic Muscular Forceps	735	Bircher-Ganske Meniscectomy Forceps	428
Berliner Percussion Hammer	18	Bircher-Granske Bone Holding Forceps	506
Bernhard Towel Forceps	213	Birkett Haemostatic Forceps	178
Bernhard Uterine Tenaculum Forceps	878	Bishop Bone Chisels	434
Berrett Uterine Tenaculum Forceps	878	Bishop Bone Gouges	433, 434
Bertillon Measuring Instrument	10	Bishop Ear Curettes	697
Bethune Rib Shears	522	Bishop Tendon Tucker	723
Beyer Bone Rongeurs	492, 498	Bishop Tongue Depressors	572
Beyer Punches	657	Bishop-Harman Ophthalmic Iris Forceps	725
Bier Amputation Saws	118	Bladder Retractor	415-418
Billeau Ear Loops	698	" Collin	416
Billeau-Micro Ear Loops	698	" Gosset	416
Billroth Retractor	325	" Jacobson	415
Billroth Trocars	231	" Judd-Masson	415
Binaural Accessories for Stethoscopes	9	" Kocher	418
Binkhorst Ophthalmic Capsular Forceps	732	" Legueu	417, 418
Biopsy Curettes	907, 908	" Millian-Bacon	417
" Asch	907	" Millin	416, 417
" Genell	908	" Quervain	416
" Gusberg	908	" Thomsan-Walker	415
" Kelly-Gray	908	" Hryntschak	869
" Kevorkian	907	Blades for Laryngoscopes	558-561
" Mod. Berlin	908	Blake Embolus Grasping Forceps	850
" Mod. Muenchen	908	Blake Gall Stone Forceps	859
" Novak	907	Blake Uterine Curettes	914
" Novak-Schoeckaert	907	Blakesley (Lewis) Nasal Polypus and Cutting Forceps	621
" Randall	907	Blakesley Nasal Polypus and Cutting Forceps	621
" Reich-Nechtow	907	Blalock Aorta Clamps	849
Biopsy Forceps for Rectum	804-806	Blascovics Ophthalmic Knives	709
" Atrauma	804	Blascovics Ophthalmic Muscular Forceps	735
" Herget	805	Blohmke Tonsil Seizing Forceps	595

TABLE OF CONTENTS

	Page		Page
Blount Bone Levers	465, 466	" Rowe-Harrison	507
Blount Retractor	333	" Self Centering	513
Blumenthal Bone Rongeurs	495	" Semb	507
Blumenthal Uterine Dressing Forceps	887	" Steinhauser	503
Boer Craniotomy Forceps	956	" Tuffier	510
Boerma Obstetrical Forceps	958	" Ulrich	512
Boettcher Ligature Carriers	590	" Van Buren	506
Boettcher Tonsil and Nasal Scissors	80	" Verbugge	512, 515
Bohler Bone Cutters	488	Bone Levers	463-472
Bohler Bone Rongeurs	497	Bone Osteotomes	434-447
Bohler Extension Bows	545	Bone Plate Benders	544
Boley Caliper	968	Bone Rongeurs	491-502
Bonaccolto Dressing Forceps	140	" Adson	496
Bonaccolto Ophthalmic Strabismus Forceps	733, 734	" Alexander	493
Bone Chisels	433-447	" Bacon	494
Bone Curettes	476-483	" Bane	496
Bone Cutting Forceps	484-490	" Beyer	492, 498
" Bohler	488	" Blumenthal	495
" Cleveland	484	" Bohler	497
" Cottle	485	" Cleveland	494
" Horsley	485, 486	" Cohen	491
" Kazanjian	485	" Cottle-Jansen	493
" Killian	488	" Echlin	499
" Liston	486, 487, 489	" Fisch	492
" Liston-Key-Horsley	490	" Freidmann	491
" Liston-Stille	489	" Frykholm	499
" Littauer-Liston	485	" Geiger	498
" Markwalder	486	" Guleke	496
" McIndoe	488	" Hakansson	495
" Muhling	488	" Jansen	493
" Niro	485	" Kleinert-Kutz	495, 498
" Ruskin-Liston	487	" Leksell	500
" Ruskin-Rowland	487	" Lempert	494, 496
" Semb	490	" Luer	492
" Stamm	486	" Luer-Freidmann	491
" Tudor-Edwards	490	" Markwalder	502
Bone Elevators	461-463	" Marquardt	497
Bone Files	473-475	" Mayfield	498
Bone Gouges	433-447	" Mead	494, 495
Bone Holding Clamp Forceps	517	" Mini-Freidmann	491
" Bunnel-Howard	517	" Olivecrona	496
" Lambert-Lowmann	517	" Peiper-Beyer	498
" Lowmann	516	" Rottgen-Ruskin	497
" Lowmann-Gerster	517	" Ruskin	497
" Lowmann-Hoglund	517	" Ruskin-Mini	497
" Perham	517	" Sauerbruch-Coryllos	502
Bone Holding Forceps	503-517	" Sauerbruch-Stille	502
" Bircher-Granske	506	" Schell	496
" Dingmann	505	" Semb	499
" Farabeuf	510	" Smith-Petersen	500
" Farabeuf-Lamotte	510	" Stellbrink	491
" Fergusson	507	" Stille	500
" Frosch	507	" Stille-Leksell	499
" Haase	503	" Stille-Luer	501
" Hey-Groves	514	" Stille-Ruskin	501
" Kern	508	" Sypert	501
" Kern-Lane	508	" Trotter	494
" Kern-Mini	508	" Universal	494
" Lamotte	511	" Zaufal	495
" Lane	509	" Zaufal-Jansen	498
" Langenbeck	507	Bone Wire Guides	546-548
" Lewin	503	" Demel	547
" Meyer	504	" Kuntscher	546
" Perman	505	" Parham	548
" Reill	504	Bone Wire Tighteners	548, 549

	Page		Page
Bone Wire Tighteners (cont'd)		Brock Micro Needle Holders	272
" Demel	548	Brock Valvulotomes	851
" Loute	548	Brock-Bailey Valvulotomes	851
Boney Tissue Forceps	131	Brodie Rectal Probes	803
Bonn Ophthalmic Strabismus Forceps	733	Brom Retractor	307
Bonney Tissue Forceps with T/C	160	Broncho-Esophagoscopy Forceps	599-604
Bores Ophthalmic Radial Keratotomy Forceps	737	" Chevalier-Jackson	599, 602
Bose Retractor	303, 379	" Jackson	604
Bose Tracheal Retractors	608	" Original-Jackson	601, 603
Bosworth Tongue Depressors	571	" Peterson	602
Boucheron Ear Speculum	680	" Rntne Hospital	601
Bovin Uterine Tenaculum Forceps	885	Broncho-Esophagoscopy Scissors	602, 603
Bowles Stethoscope	5	Bronchus and Gall Duct Clamps	187-189
Bowls	982	" Crile-Mixter	188
" Round	982	" Dean-Shallcross	189
" Solution	982	" Desjardins	189
" Wash	982	" Finochietto	188
Bowmann Discission Needles	711	" Gray	189
Bowmann Eye Speculum	702	" Lahey	188
Bowmann Ophthalmic Knives	708	" Lahey (Sweet)	188
Bowmann (Williams) Lachrymal Probes	720	" Lower	188
Bowmann Lachrymal Probes	719, 720	" McQuigg-Mixter	188
Box for Instruments	985, 986	" Mixeter-O'Shaugnessy	187
Boynton Needle Holders with T/C	267	" Mixter	187, 189
Boys-Allis Tissue and Organ Holding Forceps	767	" Rochester-Mixter	187
Bozemann Dressing and Washing Forceps	224	" Wickstrom	187
Bozemann Gynecological Scissors	83	Bronchus Forceps	536, 537
Bozemann Needle Holders	249	" Price Thomas	536
Bozemann Needle Holders with T/C	264	" Sarot	536
Bozemann Suture Instruments	291	" Semb	536
Bozemann Uterine Dressing Forceps	886	Brophy Dressing Forceps	134
Bozemann Vaginal Speculum	930	Brophy Tissue Forceps	134
Bozemann-Douglas Dressing and Washing Forceps	224	Brophy Tonsil Knives	588
Bozemann-Douglas Uterine Dressing Forceps	886	Brown Needle Holders	243
Bozemann-Fritsch Uterine Catheters	916	Brown Tissue Forceps	138
Braatz Krause Ligature Conductors	290	Brown Tonsil Snares	597
Brain Spatulas	763	Bruce Clark Needle Holders	244
" Cushing	763	Bruehl Ear Knives	689
" Heifetz	763	Bruenings (Lucas) Bone Chisels	436
" Olivecrona	763	Bruenings (Lucas) Bone Gouges	436
Braith-Waite Suture Forceps	293	Bruenings Ear Speculum	682
Brand Suction Tubes	807	Bruenings Grasping Forceps Tips	600
Brand Tendon Seizing Forceps	429, 432	Bruenings Handle Broncho-Esophagoscopy Forceps	599
Brand Tendon Seizing Instrument	430	Bruenings Nasal Knives	626
Brasstad Rib Spreaders	532	Bruenings Nasal Polypus and Cutting Forceps	621
Braun Cranioclast	956	Bruenings Tongue Depressors	570
Braun Decapitating Hooks	951	Bruenings Tonsil Knives	587
Braun Uterine Depressors	902	Bruenings Tonsil Snares	596
Braun Uterine Tenaculum Forceps	878, 879	Brunetti Bone Osteotomes	442
Braun Vaginal Speculum	932	Brunner Atrauma Intestinal Clamp Forceps	793
Braun-Stadler Bandage Scissors	107	Brunner Intestinal Clamp Forceps	777
Braun-Stadler Episiotomy Scissors	85, 953	Brunner Ligature Conductors	287, 290
Braun-Stadler Sternum Scissors	523	Brunner Ligature Needles	280, 285
Breisky (Wiener Model) Vaginal Speculum	934	Brunner Retractor	355-358
Breisky Pelvimeters	955	Brunner Rib Shears	521
Breisky Retractor	351	Bruns (Volkman) Bone Curettes	480
Breisky Vaginal Speculum	931	Bruns Amputation Saws	119
Brich Trocars	232	Bruns Bandage Scissors with T/C	103
Bridge Haemostatic Forceps	178	Bruns Bone Curettes	478, 479
Brinkerhoff Rectal Specula	797	Bruns Bone Gouges	441
Bristow Bone Levers	471	Bruns Bone Gouges	441
Bristow Raspatories	458	Bruns Chisels	441
Brock Aortic Bioptome	844	Bruns Plaster Shears	111
Brock Dilation Sounds	850	Bryant Dressing and Sponge Holding Forceps	215, 216
Brock Micro Forceps	157	Buchs Raspatories	460
		Buchs Retractor	341

	Page		Page
Buchwald Tongue Depressors	569	Cannulas (cont'd)	
Buck Ear Curettes	696	" Antrum Eicken	652
Buck Ear Knives	688	" Antrum Killian	652
Buck Ear Polypus Forceps	672	" Bellocq	653
Buck Ligature Scissors	54	" Guilen	653
Buck Paracentesis Needles	689, 690	" Hajek	653
Buck Percussion Hammers	17	" Hartmann	653
Buck Suture Scissors	294	" Myles	653
Bucket for Waste	988	" Rectal Katzenstein	807
Buck-Gramcko Bone Gouges	433	" Ritter-Halle Probes	653
Buck-Gramcko Bone Levers	464, 465	" Siebenmann	653
Buckingham Elevators	694	" Vessel Irrigating	845
Buckley Bone Chisels	433	" Vessel Irrigating Cooley	845
Buckley Retractor	379	" Vessel Irrigating Schmid	845
Bucy Neuro Knives	762	Canny Ryall Retractor	369
Buehressen Tissue Forceps	138	Caplan Septum Scissors	632
Buelau Trocars	231	Cardiovascular Atrauma Forceps	811-837
Buie Angiotribes	180	" Atlee	825
Buie Rectal Probes	803	" Castaneda	826, 829
Buie Suction Tubes	807	" Cooley	832-835
Bulldog Atrauma Clamps	808, 809	" Cooley-Glassman	836
" De Bakey	808, 809	" Dale	830
" De bakey-Carotis	809	" Dardik	831
" De Bakey-Satinsky	809	" De Bakey	811-819
" Glover	808	" De Bakey-Beck	820
" Gregory-Soft	809	" De Bakey-Harken	827
Bulldog Clamps	207, 208	" De Bakey-McQuigg-Mixer	818
" De Bakey	207	" De Bakey-Mixer	817
" De Bakey-Hess	208	" De Bakey-Rumel	817
" Dieffenbach	207	" De Bakey-Semb	816
" Johns-Hopkins	207, 208	" Derra	830
" Micro-Coron	208	" Derra-Cooley	832
" Ultra-Micro	208	Cardiovascular Atrauma Forceps	
Bumm Uterine Curettes	912	" Dick	837
Bumm Uterine Dressing Forceps	887	" Dietrich	829
Bunge Exenteration Scoops	718	" Glover	821
Bunnell Hand Drills	539	" Glover-De Bakey	825
Bunnell-Howard Bone Holding Clamp Forceps	517	" Gregory	829
Bunnell Bone Levers	464	" Henly	830
Bunnell Tendon Seizing Instrument	429, 430	" Lambert-Kay	825
Bunt Safety Pins	969	" Lambert-Kay Modif.	825
Burch Ophthalmic Knives	709	" Lees	826
Burford Rib Spreaders	529	" Leland-Jones	827
Burke Uterine Biopsy Forceps	897, 898	" Morris-De Bakey	820
Burs Corneal Storz	722	" Ochsner	829
Busch Operating Scissors	63	" Parry-Cooley	834
Busch Bone Curettes	481	" Potts	821, 822
Butcher Amputation Saws	117	" Rein	828
Byrd Suction Tubes	239	" Satinsky	824
		" Satinsky-De Bakey	824
		" Weber	828
		" Werthiem	837
C		Carmalt Splinter Forceps	145
Calipers	10, 723, 968	Caroll Tendon Seizing Forceps	432
" Boley	968	Carpenter Tonsil Knives	589
" Castroviejo	10, 723	Carrel (Reynolds) Haemostatic Forceps	161
" Castroviejo-Schachar	723	Carter Septum and Periosteal Elevators	629
" Iwanson	968	Carter Sphere Introducer	738
Campbell Trocars	231	Cartilage Forceps	428
Canad. Model Meniscectomy Knives	426	" Bircher	428
Canaliculus Punches	722	" Bircher-Ganske	428
" Haitz	722	" Herz	428
" Holth	722	" Jager	428
" Lagrange	722	" Weller	428
Canfield Tonsil Knives	587	Caspar Bone Curettes	481, 482
Cannulas	652, 653		

	Page		Page
Caspar Raspatories	457	" Thorpe	717
Caspar Retractor	307, 342	Chalazion Forceps	737-738
Caspar Rongeurs	664, 667, 668	" Ayer	737
Caspar Suture Instruments	291	" Cauer	737
Caspar Tampers	448	" Desmarres	738
Castanares Rhinoplastic Scissors	645	" Erhardt	737
Castaneda Atrauma Cardiovascular Forceps	826, 829	" Francis	738
Castaneda Neonatal and Pediatric Clamps	840	" Heath	737
Castaneda Rib Spreaders	532	" Hunt	738
Castroviejo Calipers	10, 723	" Lambert	737
Castroviejo Double Instruments	724	" Lordan	738
Castroviejo Lachrymal Dilators	720	" Snellen	737
Castroviejo Measuring Instrument	10, 723	" Spencer	738
Castroviejo Micro Needle Holders with T/C	268	" Weaver	738
Castroviejo Ophthalmic Capsular Forceps	730	" Weis	738
Castroviejo Ophthalmic Clamp	705	Chandler Ophthalmic Iris Forceps	727
Castroviejo Ophthalmic Corneal Scissors	742	Channelled Retractors	577
Castroviejo Ophthalmic Fixation Forceps	727	Chaput Tissue and Organ Holding Forceps	179, 767
Castroviejo Ophthalmic Iridectomy Scissors	742	Charnley Retractor	393
Castroviejo Ophthalmic Keratomes	707	Charriere Amputation Saws	116, 117
Castroviejo Ophthalmic Knives	706, 707	Cheattle Sterilizing Forceps	965, 966
Castroviejo Ophthalmic Micro Scissors	739	Cheek and Lip Retractors	572, 573
Castroviejo Ophthalmic Spatulas	714	Cheron Dressing and Washing Forceps	225
Castroviejo Ophthalmic Suture Forceps	733	Cherry Abdominal Retractor	407
Castroviejo Ophthalmic Tenotomy Scissors	741	Chevalier-Jackson Broncho-Esophagoscopy Forceps	599, 602
Castroviejo Ophthalmic Trephines	721, 722	Chevalier-Jackson Tracheal Tubes	610
Castroviejo Razor Blade Holder	24	Child Suture Forceps	292
Castroviejo-Colibri Ophthalmic Fixation Forceps	728	Chin Retractors	577
Castroviejo-Kalt Micro Needle Holders	269	Chiron Otoscope	12
Castroviejo-Schachar Calipers	723	Chisel Rhinoplastic	633-636
Castroviejo Micro Needle Holders	271, 272, 274	" Anderson-Neivert	636
Castroviejo-Barraquer Micro Needle Holders	274	" Cinelli	636
Cataract Operating Instruments Kirby	716	" Cottle	634
Catheter Forceps Magil	569	" Fomon	636
Catheter Introducing Forceps Sokeland	865	" Freer	633
Catheters	652, 653, 671, 865, 873, 916	" McIndoe	636
" Ear	671	" Metzbaum	633
" Ear Hartmann	671	" Moberg	636
" Ear Itard	671	" Neivert	636
" Ear Troeltsch	671	" Rubin	633, 636
Catheters Hirth	865	" Silver	635
Catheters Killian	653	" Swall	633
Catheters Uterine	916	" Walter	634
" Bozemann-Fritsch	916	Chisels Bone	433-447
" Hildebrandt	916	" Alexander	439
Catheters Van Alyea	652	" Bishop	434
Catheter Guides	873	" Bruenings (Lucas)	436
Catlin Amputation Knives	41	" Bruns Chisels Bone	441
Carotid Clamps Pertuiset	855	" Buckley	433
Cauer Chalazion Forceps	737	" Cottle	438
Caustic Holders	901	" Freer	435
Cauteries	714	" Hibbs	436
" Prince	714	" Lexer	447
" Wadsworth-Todd	714	" Lucas	438
" Wills-Hospital	714	" McEwen	440
Center Blade for Balfour Abdominal Retractor	407	" Partsch	435
Cervical Traction Tongues	755, 756	" Schwartz	433
Chadwick Scissors	48	" Stille Chisels Bone	440
Chalazion Curettes	717, 718	" Trautmann	433
" Daviel	717	" U. S. Army	439
" Graefe	717	Chisels Lachrymal Sac West	723
" Heath	718	Chisels Ophthalmic	710
" Hebra	717	" Green	710
" Meyhoefer	717	" Knapp	710
" Skeelee	717	" Nicati	710

	Page		Page
Chisels Ophthalmic (cont'd)		Clamps Bulldog (cont'd)	
" Rollet	710	" Dieffenbach	207
Cholewa Nasal Speculum	618	" Johns-Hopkins	207, 208
Choyce Ophthalmic Capsular Forceps	731	" Micro-Coron	208
Church Vascular Scissors	76	" Ultra-Micro	208
Cilia Forceps	149 & 150	Clamps Circumcision	877
" Automatic	150	" Guyon	190, 191
" Beaupre	150	" Guyon Atrauma	201
" Beer	150	" Herrick	190
" Bennett	149	" Mayo	191
" Bergh	149	" Mayo-Guyon	191
" Douglas	149	" Stille	190
" Douglas	150	Clamps Neonatal and Pediatric	837-840
" Gradle	150	" Castaneda	840
" Graefe	149	" Cooley	838, 839
" Henry	150	" Subramanian-Miniature	837
" Jameson-Evans	150	Clamps Penis	871, 872
" Kuhne	149	Clamps Peritoneal	204-206
" Littauer	149	" Baby-Mikulicz	204
" Phillips	150	" Faure	205
" Saupe	149	" Mikulicz	204-206
" Ziegler	149	" Schindler	206
Cinelli Rhinoplastic Chisel	636	Clamps Tubing	209, 210, 969
Cinelli Rhinoplastic Scissors	646	" Hoffmann	969
Circumcision Clamps	877	" Holt	969
Citelli Punches	657	" Marcuse	210
Clamp for Fixation of Spermatic cord	871	" Mod. Klinikum-Berlin	210
Clamps Aorta	849	" Mohr	969
" Blalock	849	" Sell	969
" Pott (Johns-Hopkins)	849	" Simplex	969
" Potts-Smith	849	" St. Vincent	209
Clamps Atrauma Aorta	841	" Standard	209
" Hume	841	" Ulrich	969
" Pappen-Blalock	841	Clamps Umbilical Cord	953
" Schumaker	841	" Collin	953
Clamps Bone Holding	517	" Kane	953
" Bunnel-Howard	517	Clamps Vena Cava	852, 853
" Lambert-Lowmann	517	" Baby-Satinsky	852
" Lowmann	516	" Harken	853
" Lowmann-Gerster	517	" Hopfner	852
" Lowmann-Hoglund	517	" Potts-Satinsky	852
" Perham	517	" Satinsky	852
Clamps Bronchus and Gall Duct	187-189	Clamps Vessel	854, 855
" Crile-Mixter	188	" Derra	854
" Dean-Shellcross	189	" Johns-Hopkins	854
" Desjardins	189	" Potts	854, 855
" Finocchietto	188	" Potts-Glover	854
" Gray	189	" Potts-Satinsky	855
" Lahey	188	Clark-Verhoeff Ophthalmic Fixation Forceps	729
" Lahey (Sweet)	188	Clas-Eicken Ligature Needles	285
" Lower	188	Clas-Eicken Tonsil Needles	593
" McQuigg-Mixter	188	Claus Ligature Needles	285
" Mixter-O'Shaughnessy	187	Clayman Ophthalmic Capsular Forceps	731
" Mixter	187, 189	Cleveland Bone Cutters	484
" Rochester-Mixter	187	Cleveland Bone Rongeurs	494
" Wickstrom	187	Clip Applying Forceps	754
Clamps Bulldog Atrauma	808, 809	" McKenzie	754
" De Bakey	808, 809	" McKenzie Modif.	754
" De bakey-Carotis	809	" Olivecrona-Toennis (Scoville)	754
" De Bakey-Satinsky	809	" Raney	754
" Glover	808	Clips Micro Aneurysm and Vessel	753
" Gregory-Soft	809	" Jacobson-Potts	753
Clamps Bulldog	207, 208	" Mini	753
" De Bakey	207	" Schwartz	753
" De Bakey-Hess	208	" Standard	753

	Page		Page
Cloth Scissors	108	Converse Nasal Knives	625
Cloward Modif. Retractor	398	Converse Needle Holders	241, 245
Cloward Retractor	385, 388, 398, 399	Converse Needle Holders with T/C	259, 260
Cloward Rongeurs	664	Converse Rhinoplastic Files	641
Cloward-Hoehn Retractor	400	Converse Rhinoplastic Retractors	638
Cloward-Lumber Retractor	400	Converse Rhinoplastic Scissors	645
Coakley Rhinoplastic Sharp Curettes	647	Converse Septum and Periosteal Elevators	630
Coakley Trocars	230	Conway Lid Retractors	704
Cobb Raspatories	460	Cook Eye Speculum	703
Cogswell Suction Tubes	239	Cook Rectal Specula	795
Cohen Bone Rongeurs	491	Cooley Aorta Retractors	850
Cohen Cuticle Nippers	122	Cooley Aortic Dilators	844
Cohen Raspatories	453	Cooley Atrauma Cardiovascular Forceps	832-835
Colclough (Richter) Punches	659	Cooley Atrauma Tissue Forceps	843
Colclough Punches	659, 660	Cooley Neonatal and Pediatric Clamps	838, 839
Coller-Crile Haemostatic Forceps	165	Cooley Retractor	367
Collier Needle Holders	242, 247	Cooley Rib Spreaders	524, 531
Collin Amputation Knives	41, 42	Cooley Suction Tubes	236
Collin Amputation Saws	117	Cooley Vessel Irrigating Cannulas	845
Collin Atrauma Tissue and Organ Holding Forceps	770	Cooley-Glassman Atrauma Cardiovascular Forceps	836
Collin Bladder Retractor	416	Cooper Ligature Needles	280
Collin Dressing and Washing Forceps	225	Cope Retractor	308
Collin Duval Tissue Forceps	141	Cordes (Rocenberg) Cutting Forceps Tips	600
Collin Kidney Elevating Forceps	867	Cordes Cutting Forceps Tips	600
Collin Mallet	423	Cordes Nasal Cutting Forceps	624
Collin Measuring Instrument	10	Corey Placenta and Ovum Forceps	950
Collin Operating Scalpel	31	Corneal Burs Storz	722
Collin Pelvimeters	954	Coryllos Retractor	359, 360
Collin Retractor	377, 402	Coryllos-Bethune (Collin) Rib Shears	522
Collin Rib Shears	520	Cottle (Bulldog) Rhinoplastic Scissors	645
Collin Scalpel Handle	22	Cottle Bone Chisels	438
Collin Sterilizing Forceps	966	Cottle Bone Cutters	485
Collin Suture Forceps	293	Cottle Bone Osteotomes	438
Collin Tissue and Organ Holding Forceps	179	Cottle Dressing Forceps	142
Collin Tongue Holding Forceps	578	Cottle Mallet	421
Collin Tracheal Tubes	610	Cottle Nasal Knives	625
Collin Umbilical Cord Clamps	953	Cottle Nasal Speculum	615, 616
Collin Uterine Curettes	913	Cottle Periosteal Elevators	631
Collin Uterine Elevating Forceps	888, 890	Cottle Raspatories	454, 456
Collin Uterine Sounds	900	Cottle Retractor	299, 303
Collin Vaginal Speculum	923	Cottle Rhinoplastic Chisel	634
Collin Vaginal Speculum	924, 925	Cottle Rhinoplastic Files	639
Collin-Hartmann Retractor	378	Cottle Rhinoplastic Forceps	644
Collin-Landau Vaginal Speculum	925	Cottle Rhinoplastic Hammers	647
Collin-Loktite Retractor	402	Cottle Rhinoplastic Hooks	637
Collin-Pozzi Uterine Tenaculum Forceps	881	Cottle Rhinoplastic Instruments	631
Collyer Pelvimeters	955	Cottle Rhinoplastic Osteotomes	634, 635
Colver Tonsil Knives	588	Cottle Rhinoplastic Retractors	635, 637
Colver Tonsil Seizing Forceps	594	Cottle Rhinoplastic Saws	642
Comedo Extractors	765, 766	Cottle Rhinoplastic Scissors	645
" Hebra	765	Cottle Septum and Periosteal Elevators	629, 630
" Katsch	765	Cottle Septum Scissors	632
" Saalfeld	766	Cottle Tonsil and Nasal Scissors	79
" Schamberg	766	Cottle-Jansen Bone Rongeurs	493
" Unna	766	Cottle-Masing Rhinoplastic Forceps	643
" Unna-Vidal	765	Cottle-McKenty Periosteal Elevators	631
Commander Plaster Shears	110	Cottle-Neivert Rhinoplastic Hooks	637
Cone Knives	35, 902	Cottle-Walsham Rhinoplastic Forceps	643
Cone Pituitary Curettes	761	Cotton and Wool Containers	981
Connin-Amsler Lachrymal Marker	723	Cotton Dispenser	989
Container for Dentures	986	Cotton Holders	901
Containers for Cotton Wool and Pallets	981	" Playfair	901
Containers for Instruments	979	" Sims	901
Containers for Sterilizing	980	Cotton Receptacles	989
Converse Retractor	305	Coupland Suction Tubes	238

	Page		Page
Courty Retractor	392	Curettes Bone (cont'd)	
Courty-Fontaine Retractor	392	" Caspar	481, 482
Cover Ligature Carriers	590	" Daubenspeck	479
Coxeter Ear Curettes	696	" Halle	478
Crafoord Vascular Scissors	73	" Hemingway	476
Crafoord Dissecting and Ligature Forceps	184	" Jacobson	476
Crafoord-Sellors Dissecting and Ligature Forceps	182	" Jansen	476
Crafoord Rib Spreaders and Contractors	535	" Kerpel	477
Craft Ligature Needles	286	" Kramer	482
Craig Nasal Polypus and Septum Forceps	620	" Lempert	480
Craig-Dominick Nasal Polypus and Septum Forceps	620	" Lucas	476
Cranial Openers	754, 755	" Martini	476
Cranioclast	956	" Mod. USA	479
Craniotomy Forceps Boer	956	" Schede	477
Crawford Retractor	346	" Simon	481
Crile Gall Stone Forceps	860	" Spratt	478
Crile Haemostatic Forceps	164	" Sypert	483
Crile Needle Holders	250	" Tessier	482
Crile Nerve Hooks	849	" Uffenorde	478
Crile Retractor	302, 305, 3075	" Volkmann	476, 477, 479-481
Crile-Mixter Bronchus and Gall Duct Clamps	188	" Williger	476, 479
Crile-Murray Needle Holders	243	Curettes Chalazion	717, 718
Crile-Wood Needle Holders	243	" Daviel	717
Crile-Wood Needle Holders with T/C	259	" Graefe	717
Critchett Eye Speculum	702	" Heath	718
Crotti Retractor	393	" Hebra	717
Crowin Tonsil Haemostats	596	" Meyhoefer	717
Crura Nippers Micro	679	" Skeelee	717
Crutchfield Cervical Traction Tongs	755, 756	" Thorpe	717
Culler Cyclodialysis Spatulas	714	Curettes Ear	696, 697
Culler Ophthalmic Hooklets	712	" Antoli-Candela	697
Cups for Medicine	983	" Bishop	697
Cups Sputum	986	" Buck	696
Curdy Ophthalmic Knives	709	" Coxeter	696
Curettes Adenoid	648-652	" House	697
" Barnhill	651	" Langenbeck	696
" Ingersoll	649	" Lempert	700
" La Force	650	" Shapleigh	696
" La Force-Stevenson	650	" Wolf	697
" Middleton	649	" Yankauer	697
" Moure	651	Curettes Lucas	765
" Shambaugh	650	" Fox	765
" Shambaugh (Negus)	652	" Moncorps	765
" St. Clair-Thomson	649	" Piffard	765
" Stubbs	651	" Vidal	765
" Vogel	649	" Wolff	765
Curettes Aspiration	917	Curettes Ophthalmic	710
Curettes Band Moving Scoville	761	" Abadie	710
Curettes Biopsy	907, 908	" Alvis	710
" Asch	907	" Davis	710
" Genell	908	" Ellis	710
" Gusberg	908	" Francis	710
" Kelly-Gray	908	" Plange	710
" Kevorkian	907	Curettes Ovum	952
" Mod. Berlin	908	" Cuzzi	952
" Mod. Muenchen	908	" Pestalozza	952
" Novak	907	Curettes Pituitary	760, 761
" Novak-Schoeckaert	907	" Cone	761
" Randall	907	" Nicola	760
" Reich-Nechtow	907	" Ray	760
Curettes Bone	476-483	Curettes Rhinoplastic Sharp	647
" Barth	476	" Coakley	647
" Bruns	478, 479	" Dingman	647
" Bruns (Volkmann)	480	" Faulkner	647
" Busche	481	" Pratt	647

	Page		Page
Curettes Secretion	876	Dartigues Kidney Elevating Forceps	867
Curettes Uterine	909-915	Dartigues Retractor	395
" Blake	914	Dartigues Uterine Elevating Forceps	890
" Bumm	912	Dastoor Ophthalmic Spatulas	714
" Collin	913	Dastoor Ophthalmic Strabismus Forceps	734
" Greene	912	Dastoor Ophthalmic Suture Forceps	733
" Heaney	913	Dattner Hypodermic and Biopsy Needles	240
" J. O. M. W. Type	915	Daubenspeck Bone Curettes	479
" Milan	913	Davidson Retractor	363
" Recamier	909, 910	Daviel Chalazion Curettes	717
" Sims	911, 915	Daviel Ophthalmic Scoops	715
" Sims (Herrera)	911	Davis Dressing Forceps	141
" Thomas	914	Davis Dura Dissectors	757, 758
" Wallich	913	Davis Ophthalmic Curettes	710
" Wash	916	Davis Sterilizing Forceps	968
" Zaufel (Blake)	914	Davis Vascular Dissectors	848
Curshmann Trocars	232	Davis-Boyle Mouth Gags	566
Cusco Vaginal Speculum	922, 923	Davol Micro Introduction Instruments	679
Cushing Brain Spatulas	763	Day Hooklets	699
Cushing Dressing Forceps	135	Day Tonsil Knives	588
Cushing Dressing Forceps with T/C	158, 159	De Bakey (Morris Modif.) Atrauma Sigmoid Anastomosis Forceps	793
Cushing Dura Hooks	759	De Bakey Atrauma Bulldog Clamps	808, 809
Cushing Gland Spoons	761	De Bakey Atrauma Cardiovascular Forceps	811-819
Cushing Kocher Retractor	299, 301	De Bakey Atrauma Tissue Forceps	842
Cushing Neuro Elevators	761	De Bakey Bulldog Clamps	207
Cushing Raspatories	450, 452	De Bakey Dissecting Forceps	771
Cushing Retractor	298, 299, 306	De Bakey Needle Holders with T/C	260
Cushing Rongeurs	663	De Bakey Retractor	396
Cushing Tissue Forceps	135	De Bakey Rib Spreaders	527, 528
Cushing-Taylor Dressing Forceps with T/C	159	De Bakey Scissors with T/C	89
Cuticle Nippers	122	De Bakey Special Forceps	152
Cuticle Scissors	127	De Bakey Suction Tubes	234, 235
Cutting Forceps Tips	600	De Bakey Tissue Forceps with T/C	159
" Cordes	600	De Bakey Tunneling Instruments	846
" Cordes (Rocenberg)	600	De Bakey Vascular Dilators	845
" Krause	600	De Bakey Vascular Scissors	77, 855
" Scheinmann	600	De Bakey-Bainbridge Atrauma Haemostatic Forceps	810
" Schumacher	600	De Bakey-Beck Atrauma Cardiovascular Forceps	820
Cuzzi Ovum Curettes	952	De Bakey-Carotis Atrauma Bulldog Clamps	809
Cyclodialysis Spatulas	714	De Bakey-Harken Atrauma Cardiovascular Forceps	827
" Culler	714	De Bakey-Hess Bulldog Clamps	208
" Stock	714	De Bakey-Kelly Atrauma Haemostatic Forceps	809
" Suker	714	De Bakey-Kelly-Rankin Atrauma Haemostatic Forceps	809
" Weber	714	De Bakey-McQuigg-Mixter Atrauma Cardiovascular Forceps	818
" Wecker	714	De Bakey-Mixter Atrauma Cardiovascular Forceps	817
Cystotomes Ophthalmic	713	De Bakey-Mosquito Atrauma Haemostatic Forceps	809
" Graefe	713	De Bakey-Pean Atrauma Haemostatic Forceps	810
" Meyer-Schwickerath	713	De Bakey-Rumel Atrauma Cardiovascular Forceps	817
Czerny Gall Stone Forceps	858	De Bakey-Satinsky Atrauma Bulldog Clamps	809
Czerny Rectal Specula	795	De Bakey-Semb Atrauma Cardiovascular Forceps	816
Czerny Retractor	333, 376	De Lee Obstetrical Forceps	961
Czerny Uterine Tenaculum Forceps	879	De Lee Pelvimeters	954
		De Martel-Wolfson Intestinal and Stomach Clamp Forceps	784
		De Vibiss Cranial Opener	755
		Dean Ophthalmic Knives	709
		Dean Tonsil and Nasal Scissors	80
		Dean Tonsil Knives	589
		Dean-Shallcross Bronchus and Gall Duct Clamps	189
		Deaver Operating Scissors	60
		Deaver Retractor	364-367
		Deaver Scissors with T/C	103
		Deaver-Baby Retractor	366
		Decapitating Hooks	951
		" Braun	951
		" Smellie	951
D			
Da La Roza Ligature Needles	744		
Dahlgren Cranial Opener	755		
Daily Ophthalmic Knives	709		
Dajerine Percussion Hammer	18		
Dale Atrauma Cardiovascular Forceps	830		
Dandy Haemostatic Forceps	162		
Dandy Nerve Hooks	759		
Dandy Neuro Elevators	761		
Dardik Atrauma Cardiovascular Forceps	831		
Darling Retractor	395		

	Page		Page
Delicate Scissors	44-52	Dilators Tracheal (cont'd)	
Demel Bone Wire Guides	547	" Trousseau	607
Demel Bone Wire Tighteners	548	Dilators Tracheotomy	612
Demelis Obstetrical Forceps	963	Dilators Uterine	903-906
Dench Paracentesis Needles	689	" Goodell	906
Denhardt Mouth Gags	562	" Hank	905
Denis-Browne Abdominal Retractor	412	" Hegar	903, 904
Denis-Browne Dissecting Forceps	771	" Jolly	905
Deponette	975	" Pratt	905
Depressors Uterine	902	" Sims	906
" Braun	902	" Wylie	906
" Sims	902	Dilators Van Buren	874
Derf Needle Holders	242	Dilators Vascular	845
Derf Needle Holders with T/C	258	Dingman Mouth Gags	567
Dermal Punches Keys	766	Dingman Rhinoplastic Sharp Curettes	647
Dermatology	765, 766	Dingmann Bone Holding Forceps	505
Dermor-Pierse (Colibri) Ophthalmic Fixation Forceps	736	Dintenfass Paracentesis Needles	689, 690
Dermor-Pierse Ophthalmic Fixation Forceps	736	Dissection Needles	711
Derra Atrauma Cardiovascular Forceps	830	" Bowman	711
Derra Valvulotomes	851	" Schweigger	711
Derra Vessel Clamps	854	Dishes	983
Derra-Cooley Atrauma Cardiovascular Forceps	832	Dishes Petri	983
Deschamps Ligature Needles	281, 282	Dishes Round	983
Desjardins Bronchus and Gall Duct Clamps	189	Disimpaction Forceps	585
Desjardins Gall Stone Forceps	858	Dispenser Cotton	989
Desjardins Gall Stone Scoops	861	Dispenser Gauze	989
Desjardins Probes	857	Dispenser Luniatschek	989
Desmarres Chalazion Forceps	738	Dispenser Methot	989
Desmarres Lid Retractors	704	Dispenser Phillip	989
Desmarres Ophthalmic Knives	709	Dissecting and Ligature Forceps	181-186
Desmarres Retractor	300	" Baby-Adson	181
Detachable Amputation Saws	116	" Baby-Mixter	184
Deutschmann Ophthalmic Knives	706	" Crafoord	184
Deweys Obstetrical Forceps	964	" Crafoord-Sellors	182
Diagnostic Sets	12-14	" Gemini	183
Dick Atrauma Anastomosis Forceps	789	" Johns-Hopkins	184
Dick Atrauma Cardiovascular Forceps	837	" Kelly	186
Dick Hysterectomy and Vaginal Atrauma Forceps	202	" Lawrence	186
Dieffenbach Abscess Knives	34	" Mini-Gemini	181
Dieffenbach Bulldog Clamps	207	" Mixter	183
Dieffenbach Operating Scalpel	26, 30, 32	" Mixter-Baby	184
Dietrich Atrauma Cardiovascular Forceps	829	" Nissen	181
Dietrich Scissors with T/C	102	" Overholt	181
Dietrich Vascular Scissors	74	" Overholt-Geissendoerfer	185
Dilation Sounds Brock	850	" Overholt-Mixter	182
Dilator and Spatula Robb	847	" Rumel	182
Dilators Aortic	844	" Sarot	183
" Cooley	844	" Zenker	184
" Tube	844	Dissecting Forceps	771
Dilators Dittel	875	" De Bakey	771
Dilators Gall Duct	862, 863	" Denis-Browne	771
" Bakes	863	" Duval	771
" Dittel	863	" Stille-Barraya	771
" Stucker	863	" Wangensteen	771
Dilators Guyon	874	Dissecting Scissors	46, 65-71
Dilators Lachrymal	720, 721	Dissectors Becker Oesophagus	794
" Castroviejo	720	Dissectors Dura	757-758
" Galezowsky	720	" Davis	757, 758
" Muldoon	720	" Frazier	757
" Raverdino	720	" Horsley	757
" Simpson	720	" Milligan	758
" Wilder	720	" Olivecrona	758
" Ziegler	721	" Penfield	757, 758
Dilators Tracheal	607	" Saschs	757
" Laborde	607	" Toennis	757

	Page		Page
Dissectors Fisch	694	Dressing and Sponge Holding Forceps (cont'd)	
Dissectors Hurd	590	" Lister	215
Dissectors Micro Hardy	751	" Maier	219
Dissectors Ophthalmic	718	" Noto	219
" Axenfeld	718	" Pelkmann	220
" Lang	718	" Rampley	217
Dissectors Rosen	694	" Sims-Maier	218
Dissectors Vascular	848	Dressing and Washing Forceps	221-226
" Davis	848	" Bozemann	224
" Halle	848	" Bozemann-Douglas	224
" Toennis	848	" Cheron	225
Dittel Dilators	875	" Collin	225
Dittel Gall Duct Dilators	863	" Duplay	221
Dix Ophthalmic Gouges	711	" Gross	222
Dixon-Lovelace Haemostatic Forceps	166	" Maier	223
Dockhorn Retractor	344	" Pitha	222
Dogliottie Valvulotomes	851	" Westermarck	226
Douay Uterine Biopsy Forceps	896	Dressing Drums	977
Double Instruments	724	Dressing Forceps with T/C	158-160
" Castroviejo	724	Dressing Forceps	128-143, 671
" Fisher	724	" Adson	139, 140
" Green	724	" Adson with T/C	158
" Knapp	724	" Bonaccolto	140
" Lindner	724	" Brophy	134
" McReynolds	724	" Cottle	142
" Moorfield	724	" Cushing	135
" Smith-Fisher	724	" Cushing with T/C	158, 159
" Wheeler	724	" Cushing-Taylor with T/C	159
Douglas Cilia Forceps	149, 150	" Davis	141
Douglas Tonsil and Nasal Scissors	79	" Duhresen	132
Douglas Tonsil Knives	588	" Evans with T/C	159
Douglas Trocars	231, 233	" Fricke	132
Downing Meniscectomy Knives	427	" Gerald	137
Doyen Abdominal Retractor	414	" Gerald with T/C	160
Doyen Atrauma Intestinal and Stomach Clamp Forceps	785	" Gruenwald	142
Doyen Gall Duct Forceps	856	" Gruenwald (Jansen)	142
Doyen Gynecological Scissors	82	" Gruenwald with T/C	160
Doyen Intestinal Clamp Forceps	772, 773	" Hudson (Ewald)	139
Doyen Mallet	420	" Jansen	671
Doyen Needle Holders	242	" Lucae	142
Doyen Operating Scissors	62	" Lucae	671
Doyen Raspatories	456	" Mayo-Russian	141
Doyen Retractor	349, 351, 352	" McIndoe	132
Doyen Tongue Depressors	570	" McIndoe with T/C	159
Doyen Towel Forceps	214	" Micro-Adson	139
Doyen Tubal Operation Instruments	899	" Ochsner	132
Doyen Uterine Polypus and Ovum Forceps	888	" Potts-Smith	135
Doyen Vaginal Retractors	942	" Potts-Smith with T/C	159
Doyen Vaginal Speculum	933	" Ramsay	132
Doyen-Collin Mouth Gags	563	" Rochester	138
Doyen-Jansen Mouth Gags	563	" Select	131
Doyen-Stille Retractor	343	" Semken	133
Dressing and Cotton Swab Forceps	227, 228	" Semken with T/C	160
" Emmet	228	" Standard	138
" Sauerbruch	228	" Standard with T/C	158
" Ulrich	227, 228	" Stille	132
Dressing and Sponge Holding Forceps	215-220	" Taylor	135, 136
" Bergmann-Foerster	220	" Thorpe	140
" Bryant	215, 216	" Troeltsch	143
" Duplay	217	" Troeltsch (Wilde)	143
" Fletcher (Javerts)	220	" Troeltsch (Wilde)	671
" Foerster	215-217	" Wangensteen	134
" Gross	216	" Wangensteen with T/C	160
" Heywood-Smith	219	" Waugh	134
" Kelly	217	" Wilde	143

	Page		Page
Dressing Scissors Flat Shanks	58	Ear Currettes (cont'd)	
Dressing Scissors Round Shanks	56,57	" Bishop	697
Dressing Scissors Slim Pattern	59	" Buck	696
Dressing Scissors with T/C	100, 101	" Coxeter	696
Drill Chucks	538	" House	697
Drills	538-540	" Langenbeck	696
" Bunnel	539	" Lempert	700
" Hudson	540	" Shapleigh	696
" Moore	539	" Wolf	697
" Perthes	540	" Yankauer	697
" Ralk	539	Ear Elevators	700
" Stille	538	" Lempert	700
" Stille-Sherman	538	" McHough	700
" Steinhauser	669	Ear Excavators Lempert	700
Drivers Douflex Mod. Dejerine Percussion Hammer	19	Ear Hooks	693
Droeber Splinter Forceps	146	" Barbara	693
Dublin Operating Scissors	64	" Hartmann	698
Dubois Gynecological Scissors	83	" McGee	693
Duehresen Dressing Forceps	132	Ear Knives	688, 689
Duffield Vascular Scissors	76	" Bruehl	689
Duke Trocars	232	" Buck	688
Dunkel Vaginal Speculum	934	" Lempert	688
Dunn-Dautrey Tempromandibular Joint Instruments	584	" Muck	689
Duplay Dressing and Sponge Holding Forceps	217	" Plester	688
Duplay Dressing and Washing Forceps	221	" Politzer	689
Duplay Uterine Tenaculum Forceps	878	" Rosen	688
Dupuy-Weiss Ligature Needles	284	" Schuknecht	688
Dupuy-Weiss Tonsil Needles	592	" Tabb	688
Dura Dissectors	757-758	" Wullstein	688
" Davis	757, 758	Ear Loops	697, 698
" Frazier	757	" Billeau	698
" Horsley	757	" Billeau-Micro	698
" Milligan	758	" Gardner-Brown	697
" Olivecrona	758	" Gross	697
" Penfield	757, 758	" Roser	697
" Sachs	757	Ear Needles	693
" Toennis	757	" Barbara	693
Dura Hooks	749, 759	" Rosen	693
" Adson	759	Ear Picks Barbara	693
" Cushing	759	Ear Polypus Forceps	672, 673
" Graham	759	" Bellucci	672
" Lahey	759	" Buck	672
" Sachs	759	" Hartmann	672, 673
" Toennis	759	" Hartmann-Noyes	673
Dura Knives	32, 33	" Hartmann-Weingartner	673
" Halle	32	" Hartmann-Wullstein	673
" Toennis	33	" Littauer	672
Durante Tissue Forceps	138	" Mirco	673-676
Durham Ligature Needles	285	" Quire	672
Durham Tonsil Needles	593	" Struempel	673
Duval Dissecting Forceps	771	Ear Polypus Snares	671
Duval Lung Grasping Forceps	537	" Krause	671
Duval Tissue and Organ Holding Forceps	769	" Krause-Voss	671
Duval Tissue and Organ Holding Forceps with T/C	770	" Lange-Wilde	671
Duval Tissue Forceps	138	Ear Raspatories Lempert	700
Duval-Collin Tissue and Organ Holding Forceps	769	Ear Sounds Shambaugh	700
		Ear Speculum	680-683
E		" Boucheron	680
Ear Catheters	671	" Bruenings	682
" Hartmann	671	" Erhardt	682
" Itard	671	" Gruber	681
" Troeltsch	671	" Hartmann	680
Ear Currettes	696, 697	" Holmagren	682
" Antoli-Candela	697	" Paparella	682
		" Politzer	680

	Page		Page
Ear Speculum (cont'd)		" Alderdice	592
" Richnau-Holmgren	682	" Hartmann	592
" Siegle	683	" Yankauer	592
" Toynbee	680	Elliot Obstetrical Forceps	963
" Troeltsch	681	Elliot Ophthalmic Iris Forceps	726
" Zoeliner	681	Elliot Ophthalmic Trephines	721
Ear Syringes	701	Ellis Ophthalmic Curettes	710
Ear Syringes Luer-Lock	701	Elsasser Nephrostomy Forceps	866
Eastman Vaginal Speculum	931	Elschnig Ophthalmic Advancement Forceps	736
Ebstein Percussion Hammer	18	Elschnig Ophthalmic Capsular Forceps	730
Echlin Bone Rongeurs	499	Elschnig Ophthalmic Fixation Forceps	728
Eichler Bone Files	475	Elschnig Ophthalmic Knives	709
Eicken Antrum Cannulas	652	Elschnig Ophthalmic Scoops	715
Eicken Grasping Forceps Tips	600	Emmet (Sims) Uterine Sounds	900
Eicken Tonsil Needles	593	Emmet Dressing and Cotton Swab Forceps	228
Eiselsberg Needle Holders	249	Emmet Fistula Hooks	902
Eiselsberg-Mathieu Needle Holders	255	Emmet Ligature Needles	284
Eiselsberg Ligature Scissors	53	Emmet Retractor	304
Elevators Bone	461-463	Emmet Trocars	231
" Adson	461	Endarterectomy	847
" Alderdyce	463	Endarterectomy Strippers	847
" Key	461	Endospecula	943
" Koenig	462	Engl. Model Towel Forceps	214
" McDonald	463	Engle Saw	115
" Obwegesser	462, 463	Enucleation Scissors	48
" Sebileau	462	Enucleators Micro Hardy	751
" Williger	461	Episiotomy Scissors	85, 953
Elevators Buckingham	694	Erhardt Chalazion Forceps	737
Elevators Hanke	590	Erhardt Ear Speculum	682
Elevators Lachrymal Lueneburg	723	Ermold Needle Holders	256
Elevators Larkin	694	Esmarch Anaesthesia Mask	15
Elevators Nerve Root	763, 764	Esmarch Bandage Scissors	106
" Love	764	Esmarch Plaster Knives	114
" Oldberg	764	Ethridge Hysterectomy and Vaginal Forceps	198
" Scoville	764	Evans Dressing Forceps with T/C	159
" Taylor	764	Eves Tonsil Snares	596
Elevators Neuro	761	Excavators Ear Lempert	700
" Cushing	761	Excavators for Nails	125
" Dandy	761	Exenteration Scoops Bunge	718
" Hoen	761	Extension Bows	545, 546
Elevators Periosteal	631	" Bohler	545
" Cottle	631	" Kirschner	545, 546
" Cottle-McKenty	631	" Schwarz	545
" Killian	631	" Steinmann	546
Elevators Septum and Periosteal	627-631	Extractors Comedo	765, 766
" Carter	629	" Hebra	765
" Converse	630	" Katsch	765
" Cottle	629, 630	" Saalfeld	766
" Freer-Ingals	628	" Schamberg	766
" Goldman	630	" Unna	766
" Hajek-Ballenger	628	" Unna-Vidal	765
" Halle	628	Extractors Vascular Varady	848
" Howarth	629	Eye Operating Sets	745, 746
" Joseph	628	Eye Speculum	702, 703
" Joseph-Masing	630	" Agricola	703
" Killian	628	" Arruga	703
" Kistner	628	" Axenfeld	703
" Lange	630	" Barraquer (Colibri)	702
" Masing	629	" Bowman	702
" McKenty	628, 629	" Cook	703
" Pennington	629	" Critchett	702
" Pierce	628	" Goldstein	703
" Roger	629	" Graefe	702
" Yankauer	630	" Guyton-Park	703
Elevators Tonsil	592	" Knapp-Clark	702

	Page		Page
Eye Speculum (cont'd)			
" Lancaster	702	Files for Nails	125
" Lister-Burch	702	Files Rhinoplastic	639-641
" Mellinger	703	" Aufricht	639
" Mellinger-Axenfeld	703	" Converse	641
" Mellinger-Beard	703	" Cottle	639
" Muller	703	" Fomon	641
" Murdock	703	" Gallaher	639-641
" Park	703	" Joseph	639, 640
" Park-Maumenee	703	" Lewis	639
" Pley	702	" Maltz	639
" Sauer	702	" Masing	640
" Stevenson	703	" Wiener	640
" Weiss	702	Fine Ophthalmic Tenotomy Scissors	741
" Ziegler	702	Finger Nail Instruments	519
F		Fink Bi-Prong Marker	705
Face Protecting Mask	4	Fink Ophthalmic Retractors	713
Faenkel Grasping Forceps Tips	600	Fink-Jameson Ophthalmic Muscular Forceps	735
Falcao Ophthalmic Suture Forceps	732	Finochietto Bronchus and Gall Duct Clamps	188
Falk Ligature Needles	285	Finochietto Needle Holders	247
Falk Tonsil Needles	593	Finochietto Needle Holders with T/C	264
Farabeuf Bone Holding Forceps	510	Finochietto Rib Spreaders	526, 529-532
Farabeuf Operating Scalpel	25	Finochietto-Rib Baby-Haight Rib Spreaders	531
Farabeuf Plaster Breakers	112	Finochietto-Infant Rib Spreaders	531
Farabeuf Raspatories	449	Finsen Modif. Tracheal Retractors	608
Farabeuf Retractor	376	Finsen Retractor	379
Farabeuf-Collin Raspatories	449	Finsen Tracheal Retractors	608
Farabeuf-Lambotte Bone Holding Forceps	510	Fisch Bone Rongeurs	492
Farr Retractor	395	Fisch Dissectors	694
Faulkner Rhinoplastic Sharp Curettes	647	Fisch Micro Neuro Knives	749
Faure Hysterectomy and Vaginal Forceps	197	Fisch Retractor	304
Faure Peritoneal Clamp Forceps	205	Fischer Ophthalmic Iris Forceps	726
Faure Uterine Biopsy Forceps	894	Fischer Tendon Seizing Instrument	430
Favaloro Vascular Scissors	72	Fischer Tonsil Knives	588
Featherstone Mouth Gags	563	Fischer-Art Ophthalmic Iris Forceps	726
Fehland Atrauma Sigmoid Anastomosis Forceps	792	Fisher Double Instruments	724
Feilchenfeld Splinter Forceps	147	Fistula Hooks	902
Feldheim Nail Instruments	518	" Emmet	902
Ferguson Operating Scissors	61	" Simon	902
Fergusson Angiotribes	180	Fistula Knives	33
Fergusson Bone Holding Forceps	507	" Schroeder	33
Fergusson Gall Stone Scoops	860	" Simon	33
Fergusson Haemorrhoidal Forceps	801	" Ulrich	33
Fergusson Suction Tubes	235	Fixation Clamp for Spermatic cord	871
Fergusson Vaginal Speculum	926	Flat Nose Pliers	549-551
Fergusson-Ackland Mouth Gags	562	Flat Nose Wire Holding Forceps with T/C	551
Ferris-Smith Nasal Polypus Forceps	622	Flat Nose Wire Holding Pliers	550, 551
Ferris-Smith Punches	662	Flat Nose Wire Holding Pliers with T/C	551
Ferris-Smith Tissue Forceps	131	Flataue Septum Knives	626
Ferris-Smith Tissue Forceps with T/C	160	Fletcher (Javerts) Dressing and Sponge Holding Forceps	220
Ferris-Smith-Cushing Rongeurs	662	Fleurant Trocars	233
Ferris-Smith-Kerrison Punches	654-656	Foerster Dressing and Sponge Holding Forceps	215-217
Ferrozal Ligature Conductors	289, 290	Foerster Ophthalmic Capsular Forceps	729
Files Bone	473-475	Foerster Ophthalmic Iris Forceps	726
" Aufricht	474	Foerster-Ballenger Gall Duct Forceps	856
" Eichler	475	Fomon Bone Files	474
" Fomon	474	Fomon Dissecting Scissors	65
" Gallaher	473	Fomon Nasal Knives	625
" Joseph	473	Fomon Retractor	311
" Lewis	474	Fomon Rhinoplastic Chisel	636
" Miller	473	Fomon Rhinoplastic Files	641
" Molt	473	Fomon Rhinoplastic Hooks	637, 638
" Putti	474	Fomon Rhinoplastic Scissors	646
		Fomon Tonsil and Nasal Scissors	79
		Footplate Hand Instruments	694, 695
		" House	695

	Page		Page
Footplate Hand Instruments (cont'd)		Forceps Atrauma Tissue	842, 843
" Larkin	694	" Cooley	843
" Shea	695	" De Bakey	842
Forceps Atrauma Anastomosis Dick	789	" Glassman	843
Forceps Atrauma Cardiovascular	811-837	Forceps Atrauma Tissue and Organ Holding	770
" Atlee	825	" Allis	770
" Castaneda	826, 829	" Collin	770
" Cooley	832-835	" Glassman-Allis	770
" Cooley-Glassman	836	" Glassman-Babcock	770
" Dale	830	Forceps Atrauma Ureter	872
" Dardik	831	Forceps Atrauma Uro-Tangential	203
" De Bakey	811-819	Forceps Atrauma Uterine Polypus and Ovum	888
" De Bakey-Beck	820	Forceps Biopsy for Rectum	804-806
" De Bakey-Harken	827	" Atrauma	804
" De Bakey-McQuigg-Mixter	818	" Herget	805
" De Bakey-Mixter	817	" Jackson	805
" De Bakey-Rumel	817	" Yeoman	804
" De Bakey-Semb	816	Forceps Bone Cutting	484-490
" Derra	830	" Bohler	488
" Derra-Cooley	832	" Cleveland	484
" Dick	837	" Cottle	485
" Dietrich	829	" Horsley	485, 486
" Glover	821	" Kazanjian	485
" Glover-De Bakey	825	" Killian	488
" Gregory	829	" Liston	486, 487, 489
" Henly	830	" Liston-Key-Horsley	490
" Lambert-Kay	825	" Liston-Stille	489
" Lambert-Kay Modif.	825	" Littauer-Liston	485
" Lees	826	" Markwalder	486
" Leland-Jones	827	" McIndoe	488
" Morris-De Bakey	820	" Muhling	488
" Ochsner	829	" Niro	485
" Parry-Cooley	834	" Ruskin-Liston	487
" Potts	821, 822	" Ruskin-Rowland	487
" Rein	828	" Semb	490
" Satinsky	824	" Stamm	486
" Satinsky-De Bakey	824	" Tudor-Edwards	490
" Weber	828	Forceps Bone Holding	503-517
" Werthiem	837	" Bircher-Granske	506
Forceps Atrauma Hysterectomy and Vaginal	201-203	" Bunnell-Howard	517
" Dick	202	" Dingmann	505
" Wertheim	202, 203	" Farabeuf	510
" Roger	201	" Farabeuf-Lambotte	510
Forceps Atrauma Intestinal and Stomach Clamp	785-789	" Fergusson	507
" Doyen	785	" Frosch	507
" Glassman	788	" Haase	503
" Habere	789	" Hey-Groves	514
" Hartmann	787	" Kern	508
" Kocher	786	" Kern-Lane	508
" Mayo-Robson	787	" Kern-Mini	508
" Scudder	787	" Lambert-Lowmann	517
Forceps Atrauma Intestinal Clamp	793	" Lambotte	511
" Clamp Brunner	793	" Lane	509
" Clamp Kersting	794	" Langenbeck	507
Forceps Atrauma Kidney Pedicle Clamps Guyon	201	" Lewin	503
Forceps Atrauma Prostatectomy Millin	871	" Lowmann	516
Forceps Atrauma Sigmoid Anastomosis	790-793	" Lowmann-Gerster	517
" De Bakey (Morris Modif.)	793	" Lowmann-Hoglund	517
" Fehland	792	" Meyer	504
" Glassman	790	" Perham	517, 505
" Heyes	790	" Reill	504
" Kersting	791	" Rowe-Harrison	507
" Morris	793	" Self Centering	513
" Resano	792	" Semb	507
" Veidenheimer	791	" Steinhauser	503

	Page		Page
Forceps Bone Holding (cont'd)		Forceps Dissecting (cont'd)	
" Tuffier	510	" Stille-Barraya	771
" Ulrich	512	" Wangensteen	771
" Van Buren	506	Forceps Dissecting and Ligature	181-186
" Verbrugge	512, 515	" Baby-Adson	181
Forceps Bone Screw Holding Lane	544	" Baby-Mixer	184
Forceps Broncho-Esophagoscopy	599-604	" Crafoord	184
" Chevalier-Jackson	599, 602	" Crafoord-Sellors	182
" Jackson	604	" Gemini	183
" Original-Jackson	601, 603	" Johns-Hopkins	184
" Peterson	602	" Kelly	186
" Rntne Hospital	601	" Lawrence	186
Forceps Bronchus	536, 537	" Mini-Gemini	181
" Price Thomas	536	" Mixer	183
" Sarot	536	" Mixer-Baby	184
" Semb	536	" Nissen	181
Forceps Cartilage	428	" Overholt	181
" Bircher	428	" Overholt-Geissendoerfer	185
" Bircher-Ganske	428	" Overholt-Mixer	182
" Herz	428	" Rumel	182
" Jager	428	" Sarot	183
" Weller	428	" Zenker	184
Forceps Catheter Magil	569	Forceps Dressing	128-143, 158-160, 671
Forceps Chalazion	737-738	" Adson	139, 140
" Ayer	737	" Adson with T/C	158
" Cauer	737	" Bonaccolto	140
" Desmarres	738	" Brophy	134
" Erhardt	737	" Cottle	142
" Francis	738	" Cushing	135
" Heath	737	" Cushing with T/C	158, 159
" Hunt	738	" Cushing-Taylor with T/C	159
" Lambert	737	" Davis	141
" Lordan	738	" Duehresen	132
" Snellen	737	" Evans with T/C	159
" Spencer	738	" Fricke	132
" Weaver	738	" Gerald	137
" Weis	738	" Gerald with T/C	160
Forceps Cilia	149, 150	" Gruenwald	142
" Automatic	150	" Gruenwald (Jansen)	142
" Beaupre	150	" Gruenwald with T/C	160
" Beer	150	" Hudson (Ewald)	139
" Bennett	149	" Jansen	671
" Bergh	149	" Lucae	142, 671
" Douglas	149, 150	" Mayo-Russian	141
" Gradle	150	" McIndeo	132
" Graefe	149	" McIndoe with T/C	159
" Henry	150	" Micro-Adson	139
" Jameson-Evans	150	" Ochsner	132
" Kuhne	149	" Potts-Smith	135
" Littauer	149	" Potts-Smith with T/C	159
" Phillips	150	" Ramsay	132
" Saupe	149	" Rochester	138
" Ziegler	149	" Select	131
Forceps Clip Applying	754	" Semken	133
" McKenzie	754	" Semken with T/C	160
" McKenzie Modif.	754	" Standard	138
" Olivecrona-Toennis (Scoville)	754	" Standard with T/C	158
" Raney	754	" Stille	132
Forceps Craniotomy	956	" Taylor	135, 136
Forceps Dilation Vogel	229	" Thorpe	140
Forceps Disimpaction Rowe	585	" Troeltsch	143
Forceps Dissecting	771	" Troeltsch (Wilde)	143, 671
" De Bakey	771	" Wangensteen	134
" Denis-Browne	771	" Wangensteen with T/C	160
" Duval	771	" Waugh	134

	Page		Page
Forceps Dressing (cont'd)		Forceps Grasping	141
" Wilde	143	Forceps Haemorrhoidal	800, 801
Forceps Dressing and Cotton Swab	227, 228	" Atrauma	801
" Emmet	228	" Fergusson	801
" Sauerbruch	228	" Heywood-Smith	800
" Ulrich	227, 228	" Heywood-Smith Modif.	800
Forceps Dressing and Sponge Holding	215-220	" Luer	800
" Bergmann-Foerster	220	" Mc Givney	800
" Bryant	215, 216	" Pratt-Smith	800
" Duplay	217	Forceps Haemostatic	162-178
" Fletcher (Javerts)	220	" Adson	166
" Foerster	215-217	" Allen-Kocher	170
" Gross	216	" Baby-Crile	164
" Heywood-Smith	219	" Baby-Overholt	171
" Kelly	217	" Bainbridge	170
" Lister	215	" Bainbridge-Baby	170
" Maier	219	" Bainbridge-Glasssman	169
" Noto	219	" Bengolea	167
" Pelkmann	220	" Birkett	178
" Rampley	217	" Bridge	178
" Sims-Maier	218	" Carrel (Reynolds)	161
Forceps Dressing and Washing	221-226	" Coller-Crile	165
" Bozemann	224	" Crile	164
" Bozemann-Douglas	224	" Dandy	162
" Cheron	225	" Dixon-Lovelace	166
" Collin	225	" Halstead	177
" Duplay	221	" Halstead-Mosquito	162, 163
" Gross	222	" Hartmann	161
" Maier	223	" Hartmann (Baby Mosquito)	160
" Pitha	222	" Heiss	175, 177
" Westermark	226	" Hosemann	178
Forceps Ear Polypus	672, 673	" Jacobson-Micro	163
" Bellucci	672	" Jacobson-Micro	178
" Buck	672	" Jones (Spencer-Wells)	172
" Hartmann	672, 673	" Kelly	164
" Hartmann-Noyes	673	" Kilner-Kelly	165
" Hartmann-Weingartner	673	" Klinikum Berlin	172
" Hartmann-Wullstein	673	" Kocher	171-173, 176
" Littauer	672	" Kocher (Ochsner)	174, 175
" Quire	672	" Kocher-Nippon	177
" Struempel	673	" Kronlein	171
Forceps Embolus Grasping Blake	850	" Leriche	165
Forceps Flat Nose Wire Holding with T/C	551	" Martel	176
Forceps Foreign Body Pitha	874	" Meeker	178
Forceps Gall Duct	856, 857	" Micro-Halstead	162
" Bergstroem	857	" Micro-Hartmann	161
" Doyen	856	" Mod. Klinikum Berlin	172
" Foerster-Ballenger	856	" Mosquito	161-163
" Heywood-Smith	856	" Mosquito-Dandy	162
" Heywood-Smith Modif.	856	" Moynihan	166
" Hosemann	856	" Negus	178
" Nissen	856	" Pean	169, 171, 172
Forceps Gall Stone	858-860	" Pean-Dixon	169
" Blake	859	" Pean-Nippon	170
" Crile	860	" Pratt	169
" Czerny	858	" Providence-Hospital	163
" Desjardins	858	" Rankin-Crile	164
" Mayo-Blake	860	" Rankin-Kelly	164
" Mixer	858	" Roberts	174
" Pelkmann	859	" Rochers-Pean	168
" Stille	859	" Rochester-Carmalt	174
" Tubinger Modell	859	" Rugby	178
" Turner-Warwick	860	" Schnidt	177
Forceps Gauze Marschik	591	" Skillman	163
Forceps Genito-Urinary Sachse	876	" Spencer-Wells	172, 173

	Page		Page
Forceps Haemostatic (cont'd)		Forceps Kidney Stone (cont'd)	
" Terrier	165	" Ray	865
" Toennis	176	Forceps Laryngeal	605, 606
" Willet-Martel	176	Forceps Laryngeal Polypus	582, 583
Forceps Hypophyseal	152	" Fraenkel	582, 583
Forceps Hysterectomy	192-203	" Jackson	582
" Ballentine	193	" Jurasz	583
" Dick Atrauma	202	" Lange	583
" Ethridge	198	" Tobold	582
" Faure	197	" Waldenstrom	582
" Glenner	199	Forceps Lewkowitz Lithotomy	872
" Heaney	192	Forceps Lung Grasping	537
" Heaney-Ballentine	193	" Allis	537
" Heaney-Glassman	194	" Babcock	537
" Heaney-Rezek	192	" Duval	537
" Holzhach	195	" Williams	537
" Kuffler	194	Forceps Meniscectomy	428
" Long	194	" Bircher	428
" Maingot	194	" Bircher-Ganske	428
" Phaneuf	193	" Herz	428
" Roger Atrauma	201	" Jager	428
" Segond	196	" Weller	428
" Segond-Landau	196	Forceps Micro	153-157
" Walzl	193	" Brock	157
" Werthiem	195-200	" Gerald	154
" Werthiem Atrauma	202, 203	" Gornel	154
" Werthiem-Cullen	199	" Jacobson	157
" Wiener Model	193	" Jacobson-Adson	156
Forceps Intestinal and Stomach Clamp	780-784	" Yasargil	153, 157
" Abadie	783	Forceps Micro Ear	674-676
" Babere	782	" Mini McGee Alligator	674
" Benson	783	" Wullstein-Blakesley	675
" De Martel-Wolfson	784	Forceps Micro Wire Closure	678, 679
" Kleinschmidt	783	" Greven	678
" Lane	781	" Juers	678
" Lloyd-Davis	784	" McGee	678
" Partsch	780	" Schuknecht	678
" Payr	780	Forceps Nail Penner	519
" Payr-Baby	780	Forceps Nail Splitting	518
" Roosevelt	782	Forceps Nasal Polypus	622
" Stetten	783	" Ferris-Smith	622
" Stone	784	" Kofler	622
Forceps Intestinal Clamp	772-777, 780-789	" Takahashi	622
" Allen	772	" Watson-Williams	622
" Baby-Kocher	772	" Weil	622
" Bainbridge	772	Forceps Nasal Polypus and Cutting	621-624
" Brunner	777	" Blakesley	621
" Doyen	772, 773	" Blakesley (Lewis)	621
" Hartmann	772	" Bruenings	621
" Kocher	774, 775	" Luc	621
" Mayo-Robson	773	Forceps Nasal Polypus and Septum	619-622
" Mikulicz	776	" Craig	620
" Moynihan	777	" Craig-Dominick	620
" Parker-Kerr	776	" Gruenwald (Jansen)	620
" Scudder	777	" Hartmann	619
Forceps Kidney Elevating	867	" Heymann	620
" Collin	867	" Heymann-Knight	619
" Dartigues	867	" Killian	619
" Kocher	867	" Knight	619
Forceps Kidney Pedical Clamp	868	" Littauer	619
" Werthiem Kidney	868	" Lubet-Barbon	619
" Werthiem-Cullen Kidney	868	" Noyes	620
Forceps Kidney Stone	864, 865	" Quire	620
" Heiming	864	" Tilley	620
" Randall	864, 865	" Troeltsch	620

	Page		Page
Forceps Nasal Polypus and Septum (cont'd)		Forceps Ophthalmic Expression (cont'd)	
" Westmacott	619	" Knapp	736
Forceps Nephrostomy Elsasser	866	" Prince	736
Forceps Neuro	751, 752	Forceps Ophthalmic Fixation	727-729, 736
Forceps Obstetrical	958-964	" Barraquer	728
" Anderson	962	" Barraquer (Colibri)	727
" Bailey-Williamson	961	" Barraquer-Katzin	727
" Barens	962	" Barraquer-Katzin (Colibri)	727
" Barnes-Neville	964	" Barraquer-Llovera	728
" Barton	962	" Castroviejo	727
" Boerma	958	" Castroviejo-Colibri	728
" De Lee	961	" Clark-Verhoeff	729
" Demelis	963	" Dermor-Pierse	736
" Deweys	964	" Dermor-Pierse (Colibri)	736
" Elliot	963	" Elschnig	728
" Haig-Fergusson	963	" Graefe	728
" Hawks-Dennen	961	" Green	728
" K. N. Dass	962	" Kirby-Artur	728
" Kielland	960	" Maumenee-Colibri	728
" Kielland-Luikart	960	" O'Brein	729
" Luikart	960	" Pierse	728
" Mc Lean	960	" Pierse-Colibri	728
" Mc Lean-Luikart	961	" Sauer	728
" Mc Lean-Rucker-Luikart	961	" Troutman (Colibri)	727
" Milne-Murray	963	" Verhoeff	729
" Murless	960	" Waldau	729
" Naegele	958	" Willard-Colibri	729
" Piper	959	Forceps Ophthalmic	725-738
" Simpson	958, 963	" Iris	725-727
" Simpson-Braun	959	" Iris Bishop-Harman	725
" Simpson-Luikart	959	" Iris Chandler	727
" Tarnier	964	" Iris Elliot	726
" Wrigley	958	" Iris Fischer	726
Forceps Ophthalmic Advancement	736	" Iris Fischer-Artl	726
" Barens	736	" Iris Foerster	726
" Elschnig	736	" Iris Fuchs	727
" Worth	736	" Iris Gill	727
Forceps Ophthalmic Anterior Chamber Barraquer	735	" Iris Gill-Hess	727
Forceps Ophthalmic Capsular	729-732	" Iris Graefe	725
" Arruga	730	" Iris Hess	726
" Arruga-Nizetic	730	" Iris Mod. Bonn	726, 727
" Barraquer	731	" Iris Panas	726
" Binkhorst	732	" Iris Stevens	725
" Castroviejo	730	Forceps Ophthalmic Muscular	734, 735
" Choyce	731	" Berke	735
" Clayman	731	" Blascovics	735
" Elschnig	730	" Fink-Jameson	735
" Foerster	729	" Jameson	734
" Fuchs	730	" Prince	735
" Galin	731	" Sattler	735
" Gill-Arruga	729	Forceps Ophthalmic Radial Keratotomy	737
" Gill-Fuchs	729	" Arrowsmith	737
" Green	731	" Bores	737
" Hess	730	" Kremer	737
" Hirschmann	732	" Rubman-Bores	737
" Kalt	730	Forceps Ophthalmic Skeleton Kuhnt	736
" McPherson	731	Forceps Ophthalmic Strabismus	733, 734
" Pley	730	" Barraquer Modif.	733
" Safar	731	" Bonaccolto	733, 734
" Schweigger	729	" Bonn	733
" Shepard	731	" Dastoor	734
" Stock	729	" McCullough	733
" Swiss Mod.	729	" McPherson	734
" Terson	729, 731	" Mod. Tubingen	733
Forceps Ophthalmic Expression	736	" Nugent	733

	Page		Page
Forceps Ophthalmic Strabismus (cont'd)		Forceps Special (cont'd)	
" Paufique	734	" De Bakey	152
" Schaaf	734	" Heifetz	151
" Trouthman-Rectus	734	" Hunt	151
" Tubingen	733	" Samii	152
Forceps Ophthalmic Suture	732, 733	" Tying	152
" Alabama-University	732	" Yasargil	151
" Castroviejo	733	" Yasargil-Samii	151
" Dastoor	733	Forceps Splinter	144-148
" Falcao	732	" Arthur	148
" Girad	733	" Carmalt	145
" Guist	732	" Droeber	146
" Kronfeld	732	" Feilchenfeld	147
" Kronfeld (Panas)	732	" Hunter	145, 146
" Moorfield	732	" Peet	147
Forceps Ophthalmic Tissue	732	" Physician	148
" Lester	732	" Ralk	147
" Schmidt-Rimpler	732	" Ralk (Virtus)	147
Forceps Peritoneal Clamp	204-206	" Schaaf	146
" Baby-Mikulicz	204	" Stieglitz	148
" Faure	205	" Stieglitz (Williams)	148
" Mikulicz	204-206	" Vanguard	147
" Schindler	206	" Walter	145
Forceps Placenta and Ovum	944-950	Forceps Steinhauser	669, 670
" Corey	950	Forceps Sterilizing	965-968, 973
" Kelly	948	" Cheattle	965, 966
" Kranz	950	" Collin	966
" Lewkowitz	949	" Davis	968
" Mc Clintock	948	" London-Hospital	965
" Saenger	949	" Pye-Smith (Harrison)	966
" Winter	944-948	" Rogge	965
Forceps Prosectomy	871	" Sauerbruch	967
" Millin	871	" Ulleval	965
Forceps Punch	597	Forceps Stomach Clamp	778-789
" Hartmann	597	" Moynihan	779
" Ruault	597	" Scudder	778
" Ruault-Collin	597	Forceps Suture	292, 293
" Schmeden	597	" Braith-Waite	293
Forceps Puncturing	952	" Child	292
" Herff	952	" Collin	293
" Iowa	952	" Heath	293
Forceps Razor Blade Removing	24	" Hegenbarth	292
Forceps Reamer Adson	540	" Lange	292
Forceps Rhinoplastic	642-645	" Michel	292, 293
" Asch	642	" Michel Modif.	293
" Cottle	644	" Ochsner	292
" Cottle-Masing	643	" Wachenfeldt	292
" Cottle-Walsham	643	Forceps Tendon Seizing	429-432
" Fox	644, 645	" Brand	429, 432
" Guillen	644	" Caroll	432
" Hinderer	644	" Herz	431
" Masing	644	" Jackson	432
" Ogura	644	" Jager	431
" Rubin	642	" Kleinert-Kutz	431
" Tschoepe	643	" Steinmann	429
" Walsham	643	Forceps Tissue	128-143, 158-160
" Walsham (Universal)	643	" Adlerkreutz	136
Forceps Scalp Flap	951	" Adson	139, 140
" Gauss	951	" Adson with T/C	158
" Green-Armytage	951	" Adson-Brown	139, 140
" Willett	951	" Adson-Brown with T/C	158
Forceps Septum Compression	619-620	" Adson-Graefe	140
Forceps Sinus Mackay	606	" Boney	131
Forceps Special	151, 152	" Bonney with T/C	160
" Adson	152	" Brophy	134

	Page		Page
Forceps Tissue (cont'd)		" Tuffier	179, 767
" Brown	138	" Williams	768
" Buehressen	138	Forceps Tongue Holding	578, 579
" Collin Duval	141	" Collin	578
" Cushing	135	" Guy	578
" De Bakey with T/C	159	" Heywood-Smith	579
" Durante	138	" Heywood-Smith Modif.	579
" Duval	138	" Loebker	579
" Ferris-Smith	131	" Mathieu	579
" Ferris-Smith with T/C	160	" Stille	579
" Gerald	137	" Young	579
" Gillies	132	Forceps Tonsil Seizing	594, 595
" Gillies with T/C	159	" Ballenger	594
" Gruenwald	142	" Blohmke	595
" Gruenwald (Jansen)	142	" Colver	594
" Hudson (Ewald)	139	" Leineweber	595
" Koenig	134	" Marschik-Krone	594
" Lane	137	" McWorther-Lothrop	595
" Lexer	137	" Muck	595
" Lucae	142	" Museux	595
" Micro-Adson	139	" Schnidt	594
" Micro-Adson-Biemer	140	" Thilenius	595
" Nelson	141	" Tivnen-Tyding	595
" Oehler with T/C	158	" White	594
" Potts-Smith	135	Forceps Towel	210-214
" Ramsay	132	" Backhaus	211
" Rooke	132	" Backhaus-Kocher	211
" Russian Model	138	" Bernhard	213
" Select	131, 132	" Doyen	214
" Semken	133	" Engl. Model	214
" Semken with T/C	160	" Hoff	211
" Skene	136	" Jones	214
" Skinner with T/C	160	" Lane	213
" Stille	132	" Lorna	212
" Stille-Barraya	134	" Moynihan	213
" Stone	137	" Ombredanne (Jackson)	212
" Strassburger Mod.	133	" Peers-Bertram	212
" Taylor	136	" Robin	212
" Treaves	133	" Roeder	212
" Troeltsch (Wilde)	143	" Schaedel	214
" Waugh	134	" Tohoku	212
" Williams with T/C	159	Forceps Transplant	721
" with T/C	158-160	" Berens	721
Forceps Tissue and Organ Holding	179, 180, 767-770	" Paton	721
" Allis	767	Forceps Tubal Seizing	899
" Allis-Adair	767	Forceps Ureter Calculus Lurz	866
" Allis-Babcock	769	Forceps Uterine Biopsy	891-898
" Allis-Baby	767	" Alexander	891
" Allis-Niro	768	" Appendorf	895, 898
" Babcock	769	" Baby-Tischler	898
" Babcock with T/C	770	" Burke	897, 898
" Babcock-Baby	769	" Douay	896
" Boys-Allis	767	" Faure	894
" Chaput	179, 767	" Gaylor	893
" Collin	179	" Gellhorn	893
" Duval	769	" Kevorkian	893, 898
" Duval with T/C	770	" Kevorkian-Pacific	897, 898
" Duval-Collin	769	" Krause	896
" Judd-Allis	768	" Mini-Townsend	898
" Lane	769	" Scheinmann	896
" Lockwood	768	" Schubert	891, 892
" Lockwood-Allis	768	" Schumacher	892, 895, 896
" Lovelace	768	" Schumacher-Van Doren	892
" Pennington	179	" Seidl	894
" Thoms-Allis	768	" Swiss Mod.	896

	Page		Page
Forceps Uterine Biopsy (cont'd)		Fraenkel Nasal Speculum	617, 618
" Thoms-Gaylor	893	Francis Chalazion Forceps	738
" Tischler	894, 897, 898	Francis Ophthalmic Curettes	710
" Tischler-Kevorkian	897, 898	Franz Abdominal Retractor	411
" Tischler-Morgan	897, 898	Frazier (Fergusson) Suction Tubes	235
" Van Doren	892, 893	Frazier Abdominal Retractor	410
" Wittner	895	Frazier Dura Dissectors	757
Forceps Uterine Dressing	886	Frazier Neuro Knives	762
" Blumenthal	887	Frazier Retractor	305
" Bozemann	886	Freer Bone Chisels	435
" Bozemann-Douglas	886	Freer Bone Gouges	435
" Bumm	887	Freer Nasal Knives	626
" Kelly	887	Freer Raspatories	452, 453
" Noto	887	Freer Retractor	304
" Pelkmann	886	Freer Rhinoplastic Chisel	633
Forceps Uterine Elevating	888, 890	Freer Rhinoplastic Gouges	633
" Collin	888, 890	Freer Rhinoplastic Hooks	638
" Dartigues	890	Freer Rhinoplastic Retractors	638
" Somer	889	Freer Septum Elevators	627
" Strassmann	889	Freer Septum Knives	627
Forceps Uterine Polypus and Ovum	887, 888	Freer Tonsil Knives	588
" Doyen	888	Freer-Ingals Septum and Periosteal Elevators	628
" Heywood-Smith	888	Freer-Ingals Septum Knives	627
Forceps Uterine Tenaculum	878-885	Freer-Yasargil Raspatories	453
" Abel	881	Freidmann Bone Rongeurs	491
" Adair	878	French Tuning Forks	685
" Beacham	882	Frenzel Tongue Depressors	570
" Bernhard	878	Fricke Dressing Forceps	132
" Berrett	878	Friedrich Suture Instruments	291
" Bovin	885	Friesner Paracentesis Needles	689
" Braun	878, 879	Fritsch Retractor	350, 351
" Collin-Pozzi	881	Frosch Bone Holding Forceps	507
" Czerny	879	Frykholm Bone Rongeurs	499
" Duplay	878	Fuchs Ophthalmic Capsular Forceps	730
" Gordon	879	Fuchs Ophthalmic Iris Forceps	727
" H. G. Muller with T/C	884	Fuller Micro Introduction Instruments	679
" Henrotin	885	Funnel	986
" Iowa	884		
" Jacobs	885	G	
" Jarcho	878	Galea Hooks Yasargil	756
" Kahn	882	Galezowsky Lachrymal Dilators	720
" Kustner	884	Galezowsky Lachrymal Proves	720
" Lahey	879	Galin Ophthalmic Capsular Forceps	731
" Littlewood	885	Gall Duct and Bronchus Clamps	187-189
" Museux	879, 883, 884	" Crile-Mixter	188
" Museux-Palmer	884	" Dean-Shellcross	189
" Pozzi	878, 881	" Desjardins	189
" Pozzi-Palmer	881	" Finocchietto	188
" Pratt	880	" Gray	189
" Schroeder	880, 882	" Lahey	188
" Skene	882	" Lahey (Sweet)	188
" Stade-Moore	878	" Lower	188
" Teale	885	" McQuigg-Mixter	188
Forceps Young Prostatic Lobe	872	" Mixeter-O'Shaugnessy	187
Ford Stethoscope	5	" Mixer	187, 189
Foregger Laryngoscopes	560	" Rochester-Mixter	187
Foreign Body Instruments	698	" Wickstrom	187
" Moldenhauer	698	Gall Duct Dilators	862, 863
" Zaufal	698	" Bakes	863
Fox Lucas Curettes	765	" Dittel	863
Fox Rhinoplastic Forceps	644, 645	" Stucker	863
Fracture Pins	545	Gall Duct Forceps	856, 857
" Palmer	545	" Bergstroem	857
" Wilberg	545	" Doyen	856
Fraenkel Laryngeal Polypus Forceps	582, 583		

	Page		Page
Gall Duct Forceps (cont'd)		Gill Ophthalmic Knives	709
" Foerster-Ballengier	856	Gill-Arruga Ophthalmic Capsular Forceps	729
" Heywood-Smith	856	Gill-Fuchs Ophthalmic Capsular Forceps	729
" Heywood-Smith Modif.	856	Gill-Hess Ophthalmic Iris Forceps	727
" Hosemann	856	Gillies Needle Holders	249
" Nissen	856	Gillies Needle Holders with T/C	265
Gall Stone Catchers	860	Gillies Neuro Hooklets	765
Gall Stone Forceps	858-860	Gillies Retractor	304
" Blake	859	Gillies Tissue Forceps	132
" Crile	860	Gillies Tissue Forceps with T/C	159
" Czerny	858	Gillies-Slim Needle Holders	249
" Desjardins	858	Gillies-Slim Needle Holders with T/C	265
" Mayo-Blake	860	Gil-Vernet Retractor	299
" Mixter	858	Girad Ophthalmic Suture Forceps	733
" Pelkmann	859	Girard Swan Ophthalmic Knives	710
" Stille	859	Gland Spoons Cushing	761
" Tubinger Model	859	Glassman Atrauma Intestinal and Stomach Clamp Forceps	788
" Turner-Warwick	860	Glassman Atrauma Sigmoid Anastomosis Forceps	790
Gall Stone Scoops	860-862	Glassman Atrauma Tissue Forceps	843
" Desjardins	861	Glassman-Allis Atrauma Tissue and Organ Holding Forceps	770
" Fergusson	860	Glassman-Babcock Atrauma Tissue and Organ Holding Forceps	770
" Luer-Koerte	861	Glenner Hysterectomy and Vaginal Forceps	199
" Mayo	860, 862	Glover Atrauma Bulldog Clamps	808
" Moore	862	Glover Atrauma Cardiovascular Forceps	821
Gallaher Bone Files	473	Glover-De Bakey Atrauma Cardiovascular Forceps	825
Gallaher Rhinoplastic Files	639-641	Gluck Rib Shears	520
Galt Trephine	115	Goelet Retractor	352
Gardiner-Brown Tuning Forks	686	Goldman Septum and Periosteal Elevators	630
Gardner-Brown Ear Loops	697	Goldman-Fox Scissors	45
Gauss Scalp Flap Forceps	951	Goldman-Fox Scissors with T/C	87
Gauze Cloth Scissors	108	Goldstein Eye Speculum	703
Gauze Dispenser	989	Gomel Micro Forceps	154
Gauze Forceps Marschik	591	Gomel Micro Needle Holders	274
Gauze Packers	591, 901	Gomel Suction Tubes	237
" Lewis	591	Good Tonsil and Nasal Scissors	80
" Luniatschek	591	Goodell Uterine Dilators	906
Gaylor Uterine Biopsy Forceps	893	Goodyear Tonsil Retractors	591
Geiger Bone Rongeurs	498	Gordon Uterine Tenaculum Forceps	879
Gellhorn Uterine Biopsy Forceps	893	Gorney Dissecting Scissors	65
Gelpi Retractor	397	Gorney Suction Tubes	239
Gelpi Vaginal Retractors	942	Gosset Abdominal Retractor	408
Gelpi-Baby Retractor	396	Gosset Bladder Retractor	416
Gelpi-Loktite Retractor	396, 397	Gouges Bone	433-447
Gelpi-Seiletz Retractor	396	" Alexander	439
Gemini Dissecting and Ligature Forceps	183	" Bishop	433, 434
Genell Biopsy Curettes	908	" Bruenings (Lucas)	436
Genito-Urinary Instruments	871-877	" Bruns	441
Genito-Urinary Retractors	871, 872	" Buck-Gramcko	433
" Stockmann	871	" Freer	435
" Strauss	872	" Hibbs	437
" Young	871	" Kramer	437
Genito-Urinary Sets	877	" Lexer	444, 447
Gerald Dressing Forceps	137	" Lucas	438
Gerald Dressing Forceps with T/C	160	" Mannerfelt	435
Gerald Micro Forceps	154	" McEwen	440
Gerald Tissue Forceps	137	" Mini-Lexer	443
Gerster Traction Bar	516	" Murphy	438
Gerzog Mallet	421	" Schwartz	433
Gerzog Paracentesis Needles	689	" Sheehan	435
Gerzog-Sexton Paracentesis Needles	691	" Smith-Petersen	442
Giertz-Stille Rib Shears	521	" Stille	440
Gifford-Jansen Retractor	381	" Thies	437
Gigli (Olivecrona) Wire Saws	119, 754	" U. S. Army	439
Gigli Wire Saw Handle	119, 754	" Wagner	446
Gill Ophthalmic Iris Forceps	727	" Walter	441

	Page		Page
Gouges Bone (cont'd)		Gruenwald Nasal Cutting Forceps	624
" West	435	Gruenwald Tissue Forceps	142
" Zielke	446	Guilen Cannula	653
Gouges Lachrymal Sac West	723	Guillen Rhinoplastic Forceps	644
Gouges Ophthalmic	710	Guillen Rhinoplastic Hammers	647
" Dix	711	Guist Ophthalmic Suture Forceps	732
" Kuhnt	710	Guleke Bone Rongeurs	496
" Meyer	710	Gum Scissors	86
" Walton	710	Gusberg Biopsy Curettes	908
" Walton (Todd)	710	Guthrie Ophthalmic Hooks	712
Gouges Rhinoplastic	633	Guthrie Ophthalmic Knives	709
" Freer	633	Guthrie Retractor	303
" Killian	633	Guttman Vaginal Speculum	926
" Killian-Claus	633	Guy Plaster Shears	111
Gourdet Uterine Scoops	919	Guy Tongue Holding Forceps	578
Gradle Cilia Forceps	150	Guyon Atrauma Kidney Pedicle Clamps	201
Graduated Measures	983	Guyon Catheter Guide	873
Graefe Chalazion Curettes	717	Guyon Dilators	874
Graefe Cilia Forceps	149	Guyon Genito-Urinary Sets	877
Graefe Eye Speculum	702	Guyon Kidney Pedicle Clamps	190, 191
Graefe Ophthalmic Cystotomes	713	Guyton-Lundsgaard Ophthalmic Knives	709
Graefe Ophthalmic Fixation Forceps	728	Guyton-Park Eye Speculum	703
Graefe Ophthalmic Hooklets	712	Gynecological Scissors	81-85
Graefe Ophthalmic Hooks	712		
Graefe Ophthalmic Iris Forceps	725		
Graefe Ophthalmic Knives	706-709	H	
Graefe Ophthalmic Scoops	715	H. G. Muller Uterine Tenaculum Forceps with T/C	884
Graefe Retractor	303, 307	Haab Ophthalmic Knives	709
Graefe-Arruga Ophthalmic Knives	706	Haase Bone Holding Forceps	503
Graefe-Standard Trocars	230	Haase Tampers	448
Graham Dura Hooks	759	Haberer Atrauma Intestinal and Stomach Clamp Forceps	789
Grasping Forceps	141	Haberer Retractor	374
Grasping Forceps Tips	600	Haberer Spatulas	374
" Bruenings	600	Haeggstroem Trocars	233
" Eicken	600	Haemorrhoidal Forceps	800, 801
" Faenkel	600	" Atrauma	801
" Lange	600	" Fergusson	801
" Scheinmann	600	" Heywood-Smith	800
" Seiffert	600	" Heywood-Smith Modif.	800
Grave Special Vaginal Speculum	921	" Luer	800
Graves Modif. Vaginal Speculum	920	" Mc Givney	800
Graves Vaginal Speculum	920, 921	" Pratt-Smith	800
Gray Bronchus and Gall Duct Clamps	189	Haemorrhoidal Ligators	802
Green Double Instruments	724	" Levy	802
Green Ophthalmic Capsular Forceps	731	" McGivney Modif.	803
Green Ophthalmic Chisels	710	" Rudd	803
Green Ophthalmic Fixation Forceps	728	Haemostatic Forceps	162-178
Green Ophthalmic Hooklets	712	" Adson	166
Green-Armytage Scalp Flap Forceps	951	" Allen-Kocher	170
Greene Retractor	341	" Baby-Crile	164
Greene Uterine Curettes	912	" Baby-Overholt	171
Gregory Atrauma Cardiovascular Forceps	829	" Bainbridge	170
Gregory-Soft Atrauma Bulldog Clamps	809	" Bainbridge-Baby	170
Greven Micro Wire Closure Forceps	678	" Bainbridge-Glasssman	169
Grieshaber Ophthalmic Trepines	721	" Bengolea	167
Groenholm Lid Retractors	704	" Birkett	178
Gross Dressing and Sponge Holding Forceps	216	" Bridge	178
Gross Dressing and Washing Forceps	222	" Carrel (Reynolds)	161
Gross Ear Loops	697	" Collier-Crile	165
Gruber Ear Speculum	681	" Crile	164
Gruenwald (Jansen) Dressing Forceps	142	" Dandy	162
Gruenwald (Jansen) Nasal Polypus and Septum Forceps	620	" Dixon-Lovelace	166
Gruenwald (Jansen) Tissue Forceps	142	" Halstead	177
Gruenwald Dressing Forceps	142	" Halstead-Mosquito	162, 163
Gruenwald Dressing Forceps with T/C	160	" Hartmann	161

	Page		Page
Haemostatic Forceps (cont'd)			
" Hartmann (Baby Mosquito)	160	Halle Septum and Periosteal Elevators	628
" Heiss	175, 177	Halle Vascular Dissectors	848
" Hosemann	178	Halle Vascular Spatuls	848
" Jacobson-Micro	163, 178	Halnaso Diagnostic Set	14
" Jones (Spencer-Wells)	172	Halsey Needle Holders	241
" Kelly	164	Halsey Needle Holders with T/C	258
" Kilner-Kelly	165	Halstead Haemostatic Forceps	177
" Klinikum Berlin	172	Halstead Needle Holders	246
" Kocher	171-173, 176	Halstead-Mosquito Haemostatic Forceps	162, 163
" Kocher (Ochsner)	174, 175	Hammers Rhinoplastic	647
" Kocher-Nippon	177	" Cottle	647
" Kronlein	171	" Guillen	647
" Leriche	165	" Quisling	647
" Martel	176	Hand Drills	538-540
" Meeker	178	" Bunnel	539
" Micro-Halstead	162	" Hudson	540
" Micro-Hartmann	161	" Moore	539
" Mod. Klinikum Berlin	172	" Perthes	540
" Mosquito	161-163	" Ralk	539
" Mosquito-Dandy	162	" Stille	538
" Moynihan	166	" Stille-Sherman	538
" Negus	178	Handle for Broncho-Esophagoscopy Forceps	599
" Pean	169	" Bruenings	599
" Pean	171, 172	" Huber	599
" Pean-Dixon	169	" Yeoman	599
" Pean-Nippon	170	Handle for Gigli Wire Saw	119, 754
" Pratt	169	Handles for Laryngeal Mirrors	580, 581
" Providence-Hospital	163	Handles for Laryngoscopes	556, 557
" Rankin-Crile	164	Handte Retractor	301
" Rankin-Kelly	164	Hank Uterine Dilators	905
" Roberts	174	Hanke Elevators	590
" Rochers-Pean	168	Hardy Micro Dissectors	751
" Rochester-Carmalt	174	Hardy Micro Enucleators	751
" Rugby	178	Harken Vena Cava Clamps	853
" Schnidt	177	Harms Trabecular Probes	719
" Skillman	163	Harrington Retractor	343, 362, 363
" Spencer-Wells	172, 173	Harrington-Baby Retractor	362
" Terrier	165	Harrington-Pemberton Retractor	362
" Toennis	176	Harris Tonsil Knives	589
" Willet-Martel	176	Hartert (Stereo) Stethoscope	7
Haemostats Tonsil	596	Hartmann (Baby Mosquito) Haemostatic Forceps	160
" Crowin	596	Hartmann Aspiration Tubes	573
" Vetter-Ulrich	596	Hartmann Atrauma Intestinal and Stomach Clamp Forceps	787
Hagedorn Needle Holders	257	Hartmann Cannula	653
Hagedorn Trocars	231	Hartmann Ear Catheters	671
Haglund-Stille Plaster Shears	111	Hartmann Ear Hooks	698
Haglund-Stille Plaster Spreaders	113	Hartmann Ear Polypus Forceps	672, 673
Haig-Fergusson Obstetrical Forceps	963	Hartmann Ear Speculum	680
Haight Rib Spreaders	525	Hartmann Haemostatic Forceps	161
Haitz Canaliculus Punches	722	Hartmann Intestinal Clamp Forceps	772
Hajek Cannula	653	Hartmann Nasal Cutting Forceps	623, 624
Hajek Mallet	420	Hartmann Nasal Polypus and Septum Forceps	619
Hajek Probes	857	Hartmann Nasal Speculum	613
Hajek-Ballenger Septum and Periosteal Elevators	628	Hartmann Punch Forceps	597
Hajek-Claus Nasal Cutting Forceps	623	Hartmann Tongue Depressors	570
Hajek-Kofler Punches	657, 658	Hartmann Tonsil Elevators	592
Hakansson Bone Rongeurs	495	Hartmann Tuning Forks	683, 684, 686, 687
Hakie Sterilizing Racks	970	Hartmann-Halle Nasal Speculum	613
Halle Bone Curettes	478	Hartmann-Noyes Ear Polypus Forceps	673
Halle Dura Knife	32	Hartmann-Weingartner Ear Polypus Forceps	673
Halle Nasal Knives	626	Hartmann-Wullstein Ear Polypus Forceps	673
Halle Neuro Knives	762	Harvey Jackson Retractor	391
Halle Operating Scalpel	29	Harvey Ligature Scissors	53
Halle Raspatories	452	Hawks-Dennen Obstetrical Forceps	961
		Head Bands	3

	Page		Page
Head Mirrors			
Heaney Hysterectomy Forceps	192	Heywood-Smith Modif. Haemorrhoidal Forceps	800
Heaney Needle Holders	248	Heywood-Smith Modif. Tongue Holding Forceps	579
Heaney Retractor	338	Heywood-Smith Tongue Holding Forceps	579
Heaney Uterine Curettes	913	Heywood-Smith Uterine Polypus and Ovum Forceps	888
Heaney Vaginal Retractors	942	Hibbs Blades for Laminectomy Retractors	419
Heaney-Ballentine Hysterectomy Forceps	193	Hibbs Bone Chisels	436
Heaney-Glassman Hysterectomy Forceps	194	Hibbs Bone Gouges	437
Heaney-Rezek Hysterectomy Forceps	192	Hibbs Bone Osteotomes	436, 437
Heath Chalazion Curettes	718	Hibbs Retractor	336
Heath Chalazion Forceps	737	Hildebrandt Uterine Catheters	916
Heath Ligature Scissors	53	Hinderer Rhinoplastic Forceps	644
Heath Mallet	423	Hinged Back Amputation Saws	116
Heath Suture Forceps	293	Hirschmann Ophthalmic Capsular Forceps	732
Hebra Chalazion Curettes	717	Hirschmann Ophthalmic Hooks	712
Hebra Comedo Extractors	765	Hirschmann Rectal Specula	798
Hegar Needle Holders	241, 244	Hirth Catheter	865
Hegar Needle Holders with T/C	261	Hodlick Needle Holders	243
Hegar Uterine Dilators	903, 904	Hoer Neuro Elevators	761
Hegar-Baumgartner Needle Holders	242	Hoer Raspatories	450
Hegar-Baumgartner Needle Holders with T/C	258	Hoer Retractor	400
Hegar-Vascular Needle Holders with T/C	263	Hoesel Needle Holders	256
Hegebarth Suture Forceps	292	Hoesel Needle Holders with T/C	267
Heifetz Brain Spatulas	763	Hoesel Retractor	346
Heifetz Tumor and Vessel Forceps	151	Hofer Tonsil Retractors	591
Heiming Kidney Stone Forceps	864	Hoff Towel Forceps	211
Heiss Haemostatic Forceps	175, 177	Hoffmann Tubing Clamps	969
Heister Mouth Gags	563	Hofmeister Ligature Conductors	289
Helferich-Bier Amputation Saws	118	Hohmann Bone Levers	467, 468
Heller Papillotomy Forceps	863	Hohmann-Aldinger Bone Levers	471
Hemingway Bone Curettes	476	Hoke Bone Osteotomes	436
Henley Retractor	388	Holders Caustic	901
Henly Atrauma Cardiovascular Forceps	830	Holders Cotton	901
Henner (Lempert) Retractor	381	" Playfair	901
Henning Plaster Spreaders	113	" Sims	901
Henrotin Uterine Tenaculum Forceps	885	Holders Swab for Rectum Norwood	806, 807
Henry Cilia Forceps	150	Holmagren Ear Speculum	682
Henton Suture Instruments	291	Holmann Retractor	368
Henton Tonsil Needles	592	Holt Tubing Clamps	969
Hepp/Scheidel Tubal Seizing Forceps	141	Holth Canaliculus Punches	722
Hepp-Scheidel Suction Tubes	237	Holth Ophthalmic Hooks	712
Hercules Plaster Shears	111	Holz Hooklets	699
Herff Puncturing Forceps	952	Holzbach Retractor	403
Herget Biopsy Forceps for Rectum	805	Holzbach Hysterectomy Forceps	195
Herrick Kidney Pedicle Clamps	190	Hooklets	698, 699
Hertzler Abdominal Retractor	406	" Allport	698
Hertzler Rib Spreaders	527	" Day	699
Herz Meniscectomy Forceps	428	" Holz	699
Herz Tendon Seizing Forceps	431	" Jansen	699
Hess Ophthalmic Capsular Forceps	730	" Jansen-Newhart	699
Hess Ophthalmic Iris Forceps	726	" Lucae	699
Hess Ophthalmic Scoops	715	Hooklets for Neurosurgery	765
Hessberg Ligature Needles	744	" Gillies	765
Heyes Atrauma Sigmoid Anastomosis Forceps	790	" Killner	765
Hey-Groves Bone Holding Forceps	514	Hooklets for Ophthalmology	712
Heymann Nasal Knives	625	" Arruga	712
Heymann Nasal Polypus and Septum Forceps	620	" Culler	712
Heymann Nasal Scissors	618	" Graefe	712
Heymann Rhinoplastic Scissors	646	" Green	712
Heymann Tonsil and Nasal Scissors	79	" Jameson	712
Heymann-Knight Nasal Polypus and Septum Forceps	619	" Smith	712
Heywood-Smith Dressing and Sponge Holding Forceps	219	" Stevens	712
Heywood-Smith Gall Duct Forceps	856	Hooklets Stacke	699
Heywood-Smith Haemorrhoidal Forceps	800	Hooklets Troeltsch	699
Heywood-Smith Modif. Gall Duct Forceps	856	Hooklets Wullstein	699
		Hooklets Yankauer	699

	Page		Page
Hooklets Yankauer-Jansen	699	Hufnagel Needle Holders with T/C	262
Hooks Decapitating	951	Humby Retractor	306
" Braun	951	Hume Atrauma Aortic Clamps	841
" Smellie	951	Hunt Chalazion Forceps	738
Hooks Dura	759	Hunt Tumor and Vessel Forceps	151
" Adson	759	Hunter Splinter Forceps	145, 146
" Cushing	759	Hurd Dissectors	590
" Graham	759	Hurd Tonsil Needles	593
" Lahey	759	Hylin Raspatories	457
" Sachs	759	Hypodermic and Biopsy Needles	240
" Toennis	759	" Dattner	240
Hooks Ear	693	" Klima-Rosegger	240
" Barbara	693	" Strauss	240
" Hartmann	698	Hypophyseal Forceps	152
" McGee	693	Hysterectomy and Vaginal Forceps	192-203
Hooks Fistula	902	" Dick Atrauma	202
" Emmet	902	" Ethridge	198
" Simon	902	" Faure	197
Hooks Galea Yasargil	756	" Glenner	199
Hooks Nerve	759, 760, 849	" Werthiem	197-200
" Crile	849	" Werthiem Atrauma	202, 203
" Dandy	759	" Wertheim-Cullen	199
" Krayenbuhl	749	Hysterectomy Forceps	192-203
" Scoville	760	" Ballentine	193
" Smithwick	759, 760	" Heaney	192
Hooks Ophthalmic	712	" Heaney-Ballentine	193
" Berens	712	" Heaney-Glassman	194
" Graefe	712	" Heaney-Rezek	192
" Guthrie	712	" Holzbach	195
" Hirschmann	712	" Kuffler	194
" Holth	712	" Long	194
" Mod. Bonn	712	" Maingot	194
" Mod. Tübingen	712	" Phaneuf	193
" O'Conner	712	" Segond	196
" Panas	712	" Segond-Landau	196
" Stevens	712	" Walzl	193
" Tyrel	712	" Werthiem	195-200
" Wiener	712	" Wiener Model	193
Hooks Rhinoplastic	637, 638		
" Cottle	637		
" Cottle-Neivert	637		
" Fomon	637, 638	Ilic Nail Nippers	121
" Freer	638	Inge Retractor	401
" Joseph	638	Ingersoll Adenoid Curettes	649
" Neivert	637	Instrument Boxes	985, 986
Hopfner Vena Cava Clamps	852	Instrument Containers	979
Hopkins Plaster Knives	114	Instruments for Cranial Opening	754, 755
Horsley Bone Cutters	485, 486	Instruments for Hip Nailing	544
Horsley Dura Dissectors	757	Instrument Storing Trays	984
Hosemann Gall Duct Forceps	856	Interchangeable Tubes for Broncho-Esophagoscopy Forceps	599
Hosemann Haemostatic Forceps	178	Intestinal and Stomach Clamp Atrauma Forceps	785-789
House Ear Curettes	697	" Doyen	785
House Footplate Hand Instruments	695	" Glassman	788
House Measuring Rods	694	" Habere	789
House-Dieter Micro Introduction Instruments	679	" Hartmann	787
Houzal Abdominal Retractor	404	" Kocher	786
Howarth Raspatories	454	" Mayo-Robson	787
Howarth Septum and Periosteal Elevators	629	" Scudder	787
Howell Retractor	326	Intestinal and Stomach Clamp Forceps	780-784
Hryntschak Bladder Retractors	869	" Abadie	783
Huber Handle for Broncho-Esophagoscopy Forceps	599	" Baberer	782
Hudson (Ewald) Dressing Forceps	139	" Benson	783
Hudson (Ewald) Tissue Forceps	139	" De Martel-Wolfson	784
Hudson Hand Drills	540	" Kleinschmidt	783
Hufnagel Needle Holders	245	" Lane	781

	Page		Page
Intestinal and Stomach Clamp Forceps (cont'd)			
" Lloyd-Davis	784	Jaeger Lid Plate	705
" Partsch	780	Jaeger Ophthalmic Keratomes	707
" Payr	780	Jaeger Ophthalmic Knives	707
" Payr-Baby	780	Jaeger Retractor	305
" Roosevelt	782	Jaeger-Grieshaber Ophthalmic Keratomes	707
" Stetten	783	Jaeger-Grieshaber Ophthalmic Knives	707
" Stone	784	Jager Meniscectomy Forceps	428
Intestinal Clamp Atrauma Forceps	793, 794	Jager Tendon Seizing Forceps	431
" Brunner	793	Jameson Ophthalmic Hooklets	712
" Kersting	794	Jameson Ophthalmic Muscular Forceps	734
Intestinal Clamp Forceps	772-777, 780-789	Jameson Scissors	47
" Allen	772	Jameson-Evans Cilia Forceps	150
" Baby-Kocher	772	Jamison Needle Holders	244
" Bainbridge	772	Jansen Bone Curettes	476
" Brunner	777	Jansen Bone Rongeurs	493
" Doyen	772, 773	Jansen Dressing Forceps	671
" Hartmann	772	Jansen Head Lights	4
" Kocher	774, 775	Jansen Hooklets	699
" Mayo-Robson	773	Jansen Raspatories	460
" Mikulicz	776	Jansen Retractor	381
" Moynihan	777	Jansen-Newhart Hooklets	699
" Parker-Kerr	776	Janson Needle Holders	246
" Scudder	777	Jarcho Uterine Tenaculum Forceps	878
Intra Oral Retractors	574-576	Jars	981
Intracardiac Needle Holders with T/C	263	Jars for Sterilizing	973, 977, 978
Intra-Operative Illuminators	11	Javid Carotid Clamp Forceps	822, 823
Iowa Puncturing Forceps	952	Jenning Mouth Gags	563-565
Iowa Uterine Tenaculum Forceps	884	Jewett Bone Plate Bender	544
Iris Scissors	44, 46, 48	Johns-Hopkins Bulldog Clamps	207, 208
Iris Scissors with T/C	87	Johns-Hopkins Dissecting and Ligature Forceps	184
Irrigators	981	Johns-Hopkins Vessel Clamps	854
Israel Retractor	322	Johnson Ophthalmic Knives	708, 709
Itard Ear Catheters	671	Johnson-Took Ophthalmic Knives	709
Iterson Tracheal Retractors	607	Joll (Friedman) Retractor	397
Ives-Fransler Rectal Specula	798	Joll (Friedman) Vaginal Retractors	942
Iwanson Caliper	968	Jolly Uterine Dilators	905
		Jones (Spencer-Wells) Haemostatic Forceps	172
		Jones Towel Forceps	214
		Jonesco Ligature Needles	284
J		Joseph Nasal Knives	625
J. O. M. W. Type Uterine Curettes	915	Joseph Bone Files	473
Jackson Biopsy Forceps for Rectum	805	Joseph Raspatories	452
Jackson Broncho-Esophagoscopy Forceps	604	Joseph Retractor	304
Jackson Burrows Retractor	396	Joseph Rhinoplastic Files	639, 640
Jackson Laryngeal Polypus Forceps	582	Joseph Rhinoplastic Hooks	638
Jackson Nasal Scissors	618	Joseph Rhinoplastic Instruments	642
Jackson Retractor	303, 308	Joseph Rhinoplastic Measuring Device	640
Jackson Tendon Seizing Forceps	432	Joseph Rhinoplastic Saws	640
Jackson Tracheal Retractors	609	Joseph Rhinoplastic Scissors	646
Jackson Tracheal Tubes	610	Joseph Scissors	46
Jackson Vaginal Speculum	931	Joseph Septum and Periosteal Elevators	628
Jacobi Ligature Needles	744	Joseph Septum Knives	625
Jacobs Uterine Tenaculum Forceps	885	Joseph-Masing Septum and Periosteal Elevators	630
Jacobsen Paracentesis Needles	690	Judd-Allis Tissue and Organ Holding Forceps	768
Jacobson Bladder Retractor	415	Judd-Masson Bladder Retractor	415
Jacobson Bone Curettes	476	Juers Micro Wire Closure Forceps	678
Jacobson Micro Forceps	157	Jugs for Aqua Dest	981
Jacobson Micro Needle Holders	274, 274	Jugs Universal	981
Jacobson Micro Needle Holders with T/C	268	Juillard Anaesthesia Mask	15
Jacobson Micro Neuro Knives	749	Julian Needle Holders	248
Jacobson Micro Probes	750	Julian Needle Holders with T/C	261
Jacobson Vascular Scissors	74	Jurasz Laryngeal Polypus Forceps	583
Jacobson-Adson Micro Forceps	156		
Jacobson-Micro Haemostatic Forceps	163, 178	K	
Jacobson-Potts Micro Aneurysm and Vessel Clips	753	K. N. Dass Obstetrical Forceps	962

	Page		Page
Kabierske Powder Blower	701	Kidney Pedicle Clamps (cont'd)	
Kader Retractor	372	" Mayo	191
Kader Spatulas	372	" Mayo-Guyon	191
Kader-Mathieu Needle Holders	255	" Stille	190
Kahn Uterine Tenaculum Forceps	882	Kidney Stone Forceps	864, 865
Kahre-Williger Raspatories	450	" Heiming	864
Kallmorgen Vaginal Retractors	940	" Randall	864, 865
Kallmorgen Vaginal Speculum	940	" Ray	865
Kalt Micro Needle Holders	269	Kidney Trays	987
Kalt Micro Needle Holders with T/C	268	Kielland Obstetrical Forceps	960
Kalt Ophthalmic Capsular Forceps	730	Kielland-Luikart Obstetrical Forceps	960
Kalt-Arruga Micro Needle Holders	269	Killian Antrum Cannulas	652
Kane Umbilical Cord Clamps	953	Killian Bone Cutters	488
Katsch Comedo Extractors	765	Killian Catheters	653
Katzenstein Rectal Cannulas	807	Killian Nasal Polypus and Septum Forceps	619
Katzin Ophthalmic Micro Scissors	739	Killian Nasal Speculum	615
Katzin-Barraquer Ophthalmic Micro Scissors	739	Killian Periosteal Elevators	631
Kaulich Plaster Lifter	115	Killian Raspatories	453
Kazanjan Bone Cutters	485	Killian Rectal Specula	795
Kelly Dissecting and Ligature Forceps	186	Killian Rhinoplastic Gouges	633
Kelly Dressing and Sponge Holding Forceps	217	Killian Septum and Periosteal Elevators	628
Kelly Haemostatic Forceps	164	Killian Septum Knives	627
Kelly Placenta and Ovum Forceps	948	Killian Septum Scissors	632
Kelly Rectal Specula	799	Killian-Claus Rhinoplastic Gouges	633
Kelly Retractor	348, 353	Kilner Needle Holders	242
Kelly Scissors	48	Kilner Needle Holders with T/C	259, 260
Kelly Scissors with T/C	87	Kilner Neuro Hooklets	765
Kelly Suture Scissors	294	Kilner Retractor	304, 305
Kelly Uterine Dressing Forceps	887	Kilner Rhinoplastic Retractors	638
Kelly-Gray Biopsy Curettes	908	Kilner Scissors	47, 49
Kelsey-Fry Awls	586	Kilner-Dott Mouth Gags	565
Keratomes for Ophthalmology	707	Kilner-Doughty Mouth Gags	568
" Barens	707	Kilner-Kelly Haemostatic Forceps	165
" Castroviejo	707	Kilner-Russel Mouth Gags	565
" Jaeger	707	Kirby Cataract Operating Instruments	716
" Jaeger-Grieshaber	707	Kirby-Artur Ophthalmic Fixation Forceps	728
" Papst	707	Kirk Mallet	421
" Rowland	707	Kirmission Raspatories	451
" Weeker	707	Kirsch Retractor	342
" Weiner	707	Kirschner (Semm) Abdominal Retractor	412
Kern Bone Holding Forceps	508	Kirschner Abdominal Retractor	410
Kern-Lane Bone Holding Forceps	508	Kirschner Extension Bows	545, 546
Kern-Mini Bone Holding Forceps	508	Kirschner Ligature Conductors	289, 290
Kerpel Bone Curettes	477	Kirschner Needle Holders	250
Kerrison Punches	654-656	Kirstein Nasal Scissors	618
Kersting Atrauma Intestinal Clamp Forceps	794	Kistner Septum and Periosteal Elevators	628
Kersting Atrauma Sigmoid Anastomosis Forceps	791	Klapp Retractor	313
Kevorkian Biopsy Curettes	907	Kleinert-Kutz Bone Rongeurs	495, 498
Kevorkian Uterine Biopsy Forceps	893, 898	Kleinert-Kutz Retractor	306
Kevorkian-Pacific Uterine Biopsy Forceps	897, 898	Kleinert-Kutz Tendon Seizing Forceps	431
Key Elevators	461	Kleinschmidt Intestinal and Stomach Clamp Forceps	783
Key Raspatories	458	Klima-Rosegger Hypodermic and Biopsy Needles	240
Keys Dermal Punches	766	Klinikum Berlin Haemostatic Forceps	172
Kidney Elevating Forceps	867	Klinkenbergh-Loth Vascular Scissors	73
" Collin	867	Knapp Double Instruments	724
" Dartigues	867	Knapp Ophthalmic Chisels	710
" Kocher	867	Knapp Ophthalmic Expression Forceps	736
Kidney Pedical Clamp Forceps	868	Knapp Ophthalmic Knives	708
" Werthiem Atrauma	868	Knapp Ophthalmic Retractors	713
" Werthiem	868	Knapp Ophthalmic Scoops	715
" Werthiem-Cullen	868	Knapp Retractor	309, 310
Kidney Pedicle Clamps	190, 191	Knapp Wire Scissors	51
" Guyon	190, 191	Knapp-Clark Eye Speculum	702
" Guyon Atrauma	201	Knight Nasal Polypus and Septum Forceps	619
" Herrick	190	Knight Nasal Scissors	618

	Page		Page
Knight Tonsil and Nasal Scissors	79	Knives Ophthalmic (cont'd)	
Knighton Retractor	394, 399	" Bowman	708
Knives	32-43, 123	" Burch	709
Knives Abscess	34	" Castroviejo	706, 707
Knives Amputation	41, 42	" Curdy	709
Knives Anatomy	36-40	" Daily	709
Knives Cone	35	" Dean	709
Knives Cone Ayre	902	" Desmarres	709
Knives Dura	32, 33	" Deutschmann	706
Knives Ear	688, 689	" Elschnig	709
" Bruehl	689	" Gill	709
" Buck	688	" Girard Swan	710
" Lempert	688	" Graefe	706, 708, 709
" Muck	689	" Graefe-Arruga	706
" Plester	688	" Guthrie	709
" Politzer	689	" Guyton-Lundsgaard	709
" Rosen	688	" Haab	709
" Schuknecht	688	" Jaeger	707
" Tabb	688	" Jaeger-Grieshaber	707
" Wullstein	688	" Johnson	708, 709
Knives Fistula	33	" Johnson-Took	709
Knives Lancets	35	" Knapp	708
Knives Meniscectomy	426, 427	" Kuhnt	708
" Bircher	426	" Lundsgaard	709
" Canad. Model	426	" McReynolds	709
" Downing	427	" Mod. Hamburg	708
" Lowe-Beck	427	" Mod. Tubingen	708
" Nett	427	" Papst	707
" Salenius	427	" Paton	709
" Smillie	426	" Paufigue	709
" Stryker-Scholl	426	" Rowland	707
" Swiss Model	426	" Sato	708
" Wagner	427	" Scheie	709
Knives Nail	123	" Schmith-Green	706
Knives Nasal	625, 626	" Schnaudigl	708
" Ballenger	626	" Searcy	709
" Bruenings	626	" Sichel	708
" Converse	625	" Took	709
" Cottle	625	" Troutman	710
" Fomon	625	" Walker-Lee	709
" Freer	626	" Weber	708
" Halle	626	" Weeker	707, 709
" Heymann	625	" Weiner	707
" Joseph	625	" Wheeler	706
" Krieg	625	" Ziegler	708
Knives Neuro	749, 762	Knives Plaster	114
" Bucy	762	" Esmarch	114
" Fisch	749	" Hopkins	114
" Frazier	762	" Korte	114
" Halle	762	" Reiner	114
" Jacobson	749	Knives Post Mortem	36-40
" Koos	749	Knives Scarifying	35
" Kraus	749	Knives Septum	628-627
" Olivecrona	762	" Ballenger	627
" Toennis	762	" Flataue	626
" Yasargil	749	" Freer	627
Knives Ophthalmic	705-710	" Freer-Ingals	627
" Anderson-Critchett	709	" Joseph	625
" Axenfeld	709	" Killian	627
" Barenz	707	" Maltz	626
" Barkan	709	Knives Skin Grafting	43
" Barraquer	706, 709	Knives Tonsil	587-589
" Beer	706	" Abraham	587, 588
" Berens	706	" Brophy	588
" Blascovics	709	" Bruenings	587

	Page		Page
Knives Tonsil (cont'd)			
" Canfield	587	Krayenbuhl Nerve Hooks	749
" Carpenter	589	Krayenbuhl Retractor	307
" Colver	588	Kremer Ophthalmic Radial Keratomy Forceps	737
" Day	588	Kressner Rhinoplastic Rongeurs	642
" Dean	589	Krieg Nasal Knives	625
" Douglas	588	Krishaber Tracheal Tubes	611
" Fischer	588	Krishaber-Luer Tracheal Tubes	611
" Freer	588	Kristeller (Wiener Model) Vaginal Retractors	939
" Harris	589	Kristeller (Wiener Model) Vaginal Speculum	939
" Lothrop	587	Kristeller Vaginal Retractors	935-938
" Lynch	587	Kristeller Vaginal Speculum	932, 935-938
" Milette	589	Kronecker Ligature Needles	280
" Robb	587	Kronfeld (Panas) Ophthalmic Suture Forceps	732
" Robertson	588	Kronfeld Ophthalmic Suture Forceps	732
" Tyding	587	Kronlein Haemostatic Forceps	171
" Whitehead	589	Kuettel Retractor	371
Knives Trigeminal	34	Kuettel Spatulas	371
Knorr Plaster Spreaders	113	Kuffler Hysterectomy Forceps	194
Knowles Bandage Scissors	105	Kuhne Cilia Forceps	149
Knutson Urethrography Instruments	877	Kuhnt Ophthalmic Gouges	710
Kocher (Ochsner) Haemostatic Forceps	174, 175	Kuhnt Ophthalmic Knives	708
Kocher Atrauma Intestinal and Stomach Clamp Forceps	786	Kuhnt Ophthalmic Skeleton Forceps	736
Kocher Bladder Retractor	418	Kuntscher Bone Wire Guides	546
Kocher Haemostatic Forceps	171-173, 176	Kustner Uterine Tenaculum Forceps	884
Kocher Intestinal Clamp Forceps	774, 775	Kuttner Retractor	380
Kocher Kidney Elevating Forceps	867	Kyle Ligature Carriers	590
Kocher Ligature Conductors	289		
Kocher Ligature Needles	280	L	
Kocher Retractor	301, 314, 318-320, 330, 334, 344, 374, 393	La Force Adenoid Curettes	650
Kocher Spatulas	374	La Force Ophthalmic Needles	710
Kocher-Langenbeck Retractor	331	La Force Suture Instruments	291
Kocher-Nippon Haemostatic Forceps	177	La Force-Stevenson Adenoid Curettes	650
Kocher-Wagner Retractor	345	Laborde Tracheal Dilators	607
Koenig Elevators	462	Lachrymal Dilators	720, 721
Koenig Ligature Conductors	288	" Castroviejo	720
Koenig Needle Holders	251	" Galezowsky	720
Koenig Raspatories	451	" Muldoon	720
Koenig Retractor	300	" Raverdino	720
Koenig Tissue Forceps	134	" Simpson	720
Koenig Tuning Forks	686	" Wilder	720
Koerte Retractor	371	" Ziegler	721
Koerte Spatulas	371	Lachrymal Elevators Lueneburg	723
Kofler Nasal Polypus Forceps	622	Lachrymal Marker Connin-Amsler	723
Kofler Punches	658	Lachrymal Probes	719, 720
Kogan Endospecula	943	" Bowmann	719, 720
Konrich Sterilizing Boxes	976	" Bowmann (Williams)	720
Koos Micro Neuro Knives	749	" Galezowsky	720
Korte Plaster Knives	114	" Rolf	719
Korte Retractor	317	" Ziegler	719
Korte-Wagner Retractor	319	Lachrymal Sac Gouges West	723
Kraemer Rongeurs	666	LaGrange Canaliculus Punches	722
Kramer Bone Curettes	482	LaGrange Ophthalmic Enucleation Scissors	743
Kramer Bone Gouges	437	Lahey (Sweet) Bronchus and Gall Duct Clamps	188
Kramer Raspatories	455	Lahey Bronchus and Gall Duct Clamps	188
Kramer Retractor	342	Lahey Clinic Retractor	305
Kranz Placenta and Ovum Forceps	950	Lahey Dura Hooks	759
Kraus Micro Neuro Knives	749	Lahey Retractor	326, 333
Krause Cutting Forceps Tips	600	Lahey Uterine Tenaculum Forceps	879
Krause Ear Polypus Snares	671	Lambert Chalazion Forceps	737
Krause Nasal Snares	618	Lambert-Kay Atrauma Cardiovascular Forceps	825
Krause Trocars	230	Lambert-Kay Modif. Atrauma Cardiovascular Forceps	825
Krause Uterine Biopsy Forceps	896	Lambert-Lowmann Bone Holding Clamp Forceps	517
Krause-Voss Ear Polypus Snares	671	Lambotte Bone Holding Forceps	511
Krause-Voss Nasal Snares	618	Lambotte Bone Levers	466

	Page		Page
Lambotte Bone Osteotomes	439, 443	Laryngeal Polypus Forceps (cont'd)	
Lambotte Raspatories	449	" Waldenstrom	582
Laminectomy Retractors	419	Laryngeal Scissors	605, 606
Lampert Retractor	318	Laryngoscopes	557-561
Lancaster Eye Speculum	702	Laryngoscope Foregger	560
Lancaster Retractor	380	Laryngoscope Handles	556, 557
Lancet Knives	35	Laryngoscope McIntosh	558
Lancet-Duo Lancets Knives	35	Laryngoscope Miller	561
Landau Trocars	229	Laryngoscope Negus	559
Landau Vaginal Speculum	934	Laryngoscope Blades	558-561
Landolt Raspatories	456	Lawrence Dissecting and Ligature Forceps	186
Landolt Rongeurs	665	Le Mee Tongue Depressors	571
Landolt Suction Tubes	239	Lead Hands	518
Landon Vaginal Retractors	940	Lebsche Instrument for Cranial Opening	755
Lane Bone Holding Forceps	509	Lebsche Ligature Conductors	290
Lane Bone Levers	465	Lebsche Rib Shears	521, 522
Lane Bone Plate Bender	544	Lebsche Sternum Instruments	523
Lane Bone Screw Holding Forceps	544	Lees Atrauma Cardiovascular Forceps	826
Lane Intestinal and Stomach Clamp Forceps	781	Legueu Bladder Retractor	417, 418
Lane Retractor	376	Legueu Retractor	344
Lane Screw Drivers	542, 543	Leineweber Tonsil Seizing Forceps	595
Lane Tissue and Organ Holding Forceps	769	Leksell Bone Rongeurs	500
Lane Tissue Forceps	137	Leland-Jones Atrauma Cardiovascular Forceps	827
Lane Towel Forceps	213	Lemmon Rib Spreaders and Contractors	535
Lane-Trethowan Bone Levers	465	Lempert Bone Curettes	480
Lang Ophthalmic Dissectors	718	Lempert Bone Rongeurs	494, 496
Lange Bandage Scissors	104	Lempert Ear Curettes	700
Lange Bone Levers	466	Lempert Ear Elevators	700
Lange Grasping Forceps Tips	600	Lempert Ear Excavators	700
Lange Laryngeal Polypus Forceps	583	Lempert Ear Knives	688
Lange Retractor	304	Lempert Ear Raspatories	700
Lange Septum and Periosteal Elevators	630	Lempert Micro Malleus Nippers	679
Lange Suture Forceps	292	Lempert Paracentesis Needles	691
Lange-Baby Bone Levers	466	Lempert Raspatories	454
Lange-Hohmann Bone Levers	468, 469	Lens Expressors Ophthalmic	713, 715
Lange-Hohmann Modif. Bone Levers	469	" Amenabar	715
Langenbeck Amputation Knives	42	" Barens	713
Langenbeck Amputation Saws	119	" Wilmer-Bagley	713
Langenbeck Anatomy and Post Mortem Knives	37	Leriche Haemostatic Forceps	165
Langenbeck Bone Holding Forceps	507	Leriche Retractor	372
Langenbeck Bone Levers	463, 464	Leriche Spatulas	372
Langenbeck Ear Curettes	696	Lester Ophthalmic Tissue Forceps	732
Langenbeck Finger Protectors	573	Lever Obstetric	955
Langenbeck Ligature Needles	283	Levers Bone	463-472
Langenbeck Mannerfelt Modif. Retractor	301	" Aufranc	472
Langenbeck Needle Holders	251	" Bennet	469
Langenbeck Needle Holders with T/C	268	" Blount	465, 466
Langenbeck Raspatories	451	" Bristow	471
Langenbeck Retractor	327-329, 332	" Buck-Gramcko	464, 465
Langenbeck-Green Retractor	326	" Bunnell	464
Langenbeck-Mannerfelt Modif. Retractor	326	" Hohmann	467, 468
Langenbeck-Ryder Needle Holders with T/C	268	" Hohmann-Aldinger	471
Lange-Wilde Ear Polypus Snares	671	" Lambotte	466
Lange-Wilde Nasal Snares	618	" Lane	465
Larkin Elevators	694	" Lane-Trethowan	465
Larkin Footplate Hand Instruments	694	" Lange	466
Laryngeal Forceps	605, 606	" Lange-Baby	466
Laryngeal Mirror Handles	580, 581	" Lange-Hohmann	468, 469
Laryngeal Mirrors	580, 581	" Lange-Hohmann Modif.	469
Laryngeal Polypus Forceps	582, 583	" Langenbeck	463, 464
" Fraenkel	582, 583	" Meyerding	472
" Jackson	582	" Mini-Hohmann	465
" Jurasz	583	" Murphy-Lane	471
" Lange	583	" Quervain	464
" Tobold	582	" Schumacher	470

	Page		Page
Levers Bone (cont'd)		" Craft	286
" Schumacher Mod. Wagner	471	" Da la Roza	744
" Tager	470	" Deschamps	281, 282
" Taylor	466	" Dupuy-Weiss	284
" Wagner	468, 472	" Durham	285
Levinson Ophthalmic Needles	710	" Emmet	284
Levy Haemorrhoidal Ligators	802	" Falk	285
Lewin Bone Holding Forceps	503	" Hessberg	744
Lewis Bone Files	474	" Jacobi	744
Lewis Gauze Packers	591	" Jonesco	284
Lewis Ophthalmic Scoops	715	" Kocher	280
Lewis Rhinoplastic Files	639	" Kronecker	280
Lewkowitz Lithotomy Forceps	872	" Langenbeck	283
Lewkowitz Placenta and Ovum Forceps	949	" Nager	285
Lexer Bone Chisels	447	" Pauchet	284
Lexer Bone Gouges	444, 447	" Payer	283
Lexer Bone Osteotomes	444, 447	" Schmeiden Dick	279
Lexer Scissors with T/C	90	" Schmieden	279
Lexer Tissue Forceps	137	" Syme	286
Lexer-Baby (Knapp) Dissecting Scissors	67	" Trelat	285
Lexer-Baby (Knapp) Scissors with T/C	89	" Woodruff	744
Lexer-Fino Dissecting Scissors	67	" Yankauer	284
Lichtenberg Needle Holders	253	" Young	279
Lichtenberg Needle Holders with T/C	266, 267	" Young-Hryntschan	279
Lichtwitz Trocars	230, 231	Ligature Scissors	53-55
Lid Everters	704	Lillianthal Rib Spreaders	533
" Berens	704	Lincoln Vascular Scissors	76
" Muldoon	704	Lindemann Amputation Saws	119
" Pess	704	Lindner Double Instruments	724
" Schepens	704	Lip and Cheek Retractors	572, 573
" Siniscal-Smith	704	Lister Bandage Scissors	105-107
Lid Expressor Amenabar	704	Lister Bandage Scissors with T/C	103
Lid Retractors	704	Lister Dressing and Sponge Holding Forceps	215
" Conway	704	Lister Excentric Bandage Scissors	106
" Desmarres	704	Lister-Burch Eye Speculum	702
" Groenholm	704	Liston Amputation Knives	41
Ligators Haemorrhoidal	802	Liston Bone Cutters	486, 487, 489
" Levy	802	Liston-Key-Horsley Bone Cutters	490
" McGivney Modif.	803	Liston-Stille Bone Cutters	489
" Rudd	803	Littauer Cilia Forceps	149
Ligature Carriers	590	Littauer Ear Polypus Forceps	672
" Boettcher	590	Littauer Ligature Scissors	54
" Cover	590	Littauer Nasal Polypus and Septum Forceps	619
" Kyle	590	Littauer-Liston Bone Cutters	485
" Roeder	590	Little Retractor	301
Ligature Conductors	287-290	Littler Dissecting Scissors	71
" Braatz Krause	290	Littler Rhinoplastic Scissors	645
" Brunner	287, 290	Littlewood Uterine Tenaculum Forceps	885
" Ferrozel	289, 290	Lloyd-Davis (Goligher's) Rectal Scissors	801
" Hofmeister	289	Lloyd-Davis (St. Marks) Pelvis Retractors	800
" Kirschner	289, 290	Lloyd-Davis Intestinal and Stomach Clamp Forceps	784
" Kocher	289	Lloyd Instrument for Hip Nailing	544
" Koenig	288	Lockhart-Mummery Rectal Probes	803
" Lebsche	290	Locklin Gum Scissors	86
" Payr	289	Locklin Scissors	48
" Schmieden	288	Locklin Scissors with T/C	88
" Schmieden-Payr	288	Locklin Suture Scissors	294
" Stille	288	Lockwood Tissue and Organ Holding Forceps	768
Ligature Guides Micro	750	Lockwood-Allis Tissue and Organ Holding Forceps	768
Ligature Guides Micro Yasargil	750	Loebker Tongue Holding Forceps	579
Ligature Needles	279-286, 744	Logan Retractor	379
" Brunner	280, 285	London-Hospital Sterilizing Forceps	965
" Clas-Eicken	285	Long Hysterectomy Forceps	194
" Claus	285	Loops Ear	697, 698
" Cooper	280	" Billeau	698

	Page		Page
Loops Ear (cont'd)			
" Billeau-Micro	698	Luniatschek Gauze Packers	591
" Gardner-Brown	697	Lurz Ureter Calculus Forceps	866
" Gross	697	Lynch Tonsil Knives	587
" Roser	697		
Lordan Chalazion Forceps	738		
Lorenz Bandage Scissors	107	M	
Lorna Towel Forceps	212	M. G. H. Needle Holders	244
Lothrop Tonsil Knives	587	MacDonald Raspatories	453
Lothrop Tonsil Retractors	591	Machatt Retractor	310
Loute Bone Wire Tighteners	548	Mackay Sinus Forceps	606
Love (Morse) Retractor	302	Mackay Sinus Forceps	606
Love Nerve Root Retractors	764	Mackensen Trabecular Probes	719
Love Retractor	302	Mackenzie Tonsillectomes	598
Love Tonsil Retractors	591	Magil Catheter Forceps	569
Love-Gruenwald Rongeurs	663	Maier Dressing and Sponge Holding Forceps	219
Lovelace Tissue and Organ Holding Forceps	768	Maier Dressing and Washing Forceps	223
Lowe-Beck Meniscectomy Knives	427	Maier Scarifying Knives	35
Lower Bronchus and Gall Duct Clamps	188	Maingot Hysterectomy Forceps	194
Lower Trocars	232	Mallets	420-425
Lowmann Bone Holding Clamp Forceps	516	" Bergmann	421
Lowmann-Gerster Bone Holding Clamp Forceps	517	" Bergmann (Hibbs)	421
Lowmann-Hoglund Bone Holding Clamp Forceps	517	" Collin	423
Loez-Reinke Suction Tubes	239	" Cottle	421
Lubet-Barbon Nasal Polypus and Septum Forceps	619	" Doyen	420
Luc Nasal Polypus and Cutting Forceps	621	" Gerzog	421
Lucae (Royce) Paracentesis Needles	691	" Hajek	420
Lucae Dressing Forceps	142, 671	" Heath	423
Lucae Hooklets	699	" Kirk	421
Lucae Mallet	420	" Lucae	420
Lucae Paracentesis Needles	690	" Mead	420
Lucae Retractor	306	" Ombroedanne	421
Lucae Tissue Forceps	142	" Partsch	423
Lucae Tuning Forks	684, 686	" Steinbach	423
Lucas Bone Chisels	438	" Wagner	424
Lucas Bone Curettes	476	" Williger	420
Lucas Bone Gouges	438	Maltz Rhinoplastic Files	639
Lucas Curettes	765	Maltz Septum Knives	626
" Fox	765	Mannerfelt Modif. Bone Osteotomes	435
" Moncorps	765	Mannerfelt Bone Gouges	435
" Piffard	765	Mannerfelt Modif. Raspatories	458
" Vidal	765	Mannerfelt Modif. Retractor	300, 301, 308-310
" Wolff	765	Marcuse Tubing Clamps	210
Lueneburg Lachrymal Elevators	723	Markham-Meyerding Retractor	394
Luer Bone Rongeurs	492	Markwalder Bone Cutters	486
Luer Haemorrhoidal Forceps	800	Markwalder Bone Rongeurs	502
Luer Retractor	302, 308, 375	Marquardt Bone Rongeurs	497
Luer Spud	710	Marquet Foreign Body Levers	672
Luer Tracheal Retractors	609	Marschik Gauze Forceps	591
Luer Tracheal Tubes	611	Marschik-Krone Tonsil Seizing Forceps	594
Luer-Freidmann Bone Rongeurs	491	Martel Haemostatic Forceps	176
Luer-Koerte Gall Stone Scoops	861	Martel Instrument for Cranial Opening	755
Luer-Lock Ear Syringes	701	Martini Bone Curettes	476
Luethy-Beck Needle Holders	256	Masing Needle Holders with T/C	258
Luethy-Beck Needle Holders with T/C	267	Masing Retractor	298
Luikart Obstetrical Forceps	960	Masing Rhinoplastic Files	640
Lukens Retractor	308	Masing Rhinoplastic Forceps	644
Lukens Tracheal Retractors	609	Masing Rhinoplastic Retractors	637
Lundsgaard Ophthalmic Knives	709	Masing Septum and Periosteal Elevators	629
Lung Grasping Forceps	537	Mask, Anaesthesia	15
" Allis	537	Mask, Face Protecting	4
" Babcock	537	Mason Mouth Gags	562
" Duval	537	Mason Plaster Breakers	112
" Williams	537	Mason-Ackland Mouth Gags	562
Luniatschek Cotton Dispenser	989	Masson Needle Holders	246
		Masson Needle Holders with T/C	264

	Page		Page
Masson-Luethy Needle Holders	246	McIndoe Rhinoplastic Chisel	636
Mathie-Kersten Needle Holders	253	McIndoe Rhinoplastic Scissors	645
Mathieu Needle Holders	252, 254	McIndoe Vascular Scissors	73
Mathieu Raspatories	457	McIntosh Laryngoscopes	558
Mathieu Rectal Specula	795	McIvor Mouth Gags	567
Mathieu Retractor	376	McKenty Raspatories	449
Mathieu Tongue Holding Forceps	579	McKenty Septum and Periosteal Elevators	628, 629
Mathieu Vaginal Speculum	932	McKenzie Clip Applying Forceps	754
Mathieu-Kocher Needle Holders	252, 254	Mc-Kenzie Cranial Opener	754
Mathieu-Kocher Needle Holders with T/C	266	McKenzie Modig. Clip Applying Forceps	754
Mathieu-Slim Needle Holders with T/C	266	McPherson Ophthalmic Capsular Forceps	731
Mathieu-Stille Needle Holders	254	McPherson Ophthalmic Strabismus Forceps	734
Mathieu-Sverige Needle Holders	253	McPherson-Vannas Ophthalmic Micro Scissors	741
Matson Raspatories	458	McPherson-Westcott Ophthalmic Tenotomy Scissors	741
Matzenauer Vaginal Speculum	934	McQuigg-Mixer Bronchus and Gall Duct Clamps	188
Maumenee-Colibri Ophthalmic Fixation Forceps	728	McReynolds Double Instruments	724
Maunoir Scissors	47	McReynolds Ophthalmic Knives	709
Maxillary Mobilizers	584	McWorther-Lothrop Tonsil Seizing Forceps	595
Mayfield Bone Rongeurs	498	Mead Bone Rongeurs	494, 495
Mayo Gall Stone Scoops	860, 862	Mead Mallet	420
Mayo Kidney Pedicle Clamps	191	Mead Raspatories	452
Mayo Needle Holders	256	Measuring Instruments	10, 640, 841, 968
Mayo Operating Scissors	62	" Bertillon	10
Mayo Probes	857	" Castroviejo	10
Mayo Safety Pins	969	" Device	841
Mayo Scissors with T/C	91	" Device Rhinoplastic Joseph	640
Mayo Skin Grafting Knives	43	" Moeltgen	10
Mayo Tongue Depressors	570	" Thole	10
Mayo Uterine Sounds	900	Medicine Cups	983
Mayo-Adams Retractor	386, 395	Medicine Spoons	983
Mayo-Blake Gall Stone Forceps	860	Medina Uterine Biopsy Forceps	894
Mayo-Collin Retractor	377	Meeker Haemostatic Forceps	178
Mayo-Guyon Kidney Pedicle Clamps	191	Mehmke Micro Crura Nippers	679
Mayo-Harrington Operating Scissors	62	Meillinger Retractor	380
Mayo-Harrington Scissor with T/C	93	Mellinger Eye Speculum	703
Mayo-Hegar (Heaney) Needle Holders with T/C	261	Mellinger-Axenfeld Eye Speculum	703
Mayo-Hegar Needle Holders	241	Mellinger-Beard Eye Speculum	703
Mayo-Hegar Needle Holders with T/C	261	Meniscectomy Forceps	428
Mayo-Hegar Seeley Needle Holders	243	" Bircher	428
Mayo-Hegar-Seeley Needle Holders with T/C	261	" Bircher-Ganske	428
Mayo-Lexer Scissors with T/C	90	" Herz	428
Mayo-Noble Gynecological Scissors	84	" Jager	428
Mayo-Robson Atrauma Intestinal and Stomach Clamp Forceps	787	" Weller	428
Mayo-Robson Intestinal Clamp Forceps	773	Meniscectomy Knives	426, 427
Mayo-Russian Dressing Forceps	141	" Bircher	426
Mayo-Stille Operating Scissors	61	" Canad. Model	426
Mayo-Stille Scissors with T/C	92	" Downing	427
Mc Ciintock Placenta and Ovum Forceps	948	" Lowe-Beck	427
Mc Givney Haemorrhoidal Forceps	800	" Nett	427
Mc Lean Obstetrical Forceps	960	" Salenius	427
Mc Lean-Luikart Obstetrical Forceps	961	" Smillie	426
Mc Lean-Rucker-Luikart Obstetrical Forceps	961	" Stryker-Scholl	426
McClure Ophthalmic Micro Scissors	740	" Swiss Model	426
McCullough Ophthalmic Strabismus Forceps	733	" Wagner	427
McDonald Elevators	463	Method Cotton Dispenser	989
McEwen Bone Chisels	440	Metzenbaum Dissecting Scissors	71
McGannan Ophthalmic Retractors	713	Metzenbaum Needle Holders	248
McGee Ear Hooks	693	Metzenbaum Rhinoplastic Chisel	633
McGee Micro Wire Closure Forceps	678	Metzenbaum Scissors with T/C	94, 96
McGivney Modif. Haemorrhoidal Ligators	803	Metzenbaum-Fino Dissecting Scissors	65, 66
McGuire Ophthalmic Enucleation Scissors	743	Metzenbaum-Fino Scissors with T/C	95-99
McHough Ear Elevators	700	Metzenbaum-Lahey Scissors with T/C	96
McIndeo Dressing Forceps	132	Metzenbaum-Mathieu Needle Holders	251
McIndoe Bone Cutters	488	Metzenbaum-Mathieu Needle Holders with T/C	266
McIndoe Dressing Forceps with T/C	159	Metzenbaum-Nelson Dissecting Scissors	68-70

	Page		Page
Metzenbaum-Thorek Scissors with T/C	97	Micro Ophthalmic Micro Scissors	740
Meyer Bone Holding Forceps	504	Micro Probes	750
Meyer Ophthalmic Gouges	710	" Jacobson	750
Meyerding Blades for Laminectomy Retractors	419	" Yasargil	750
Meyerding Bone Levers	472	Micro Raspatories Yasargil	750
Meyerding Retractor	313, 339, 394	Micro Scoops Yasargil	750
Meyer-Schwickerath Ophthalmic Cystotomes	713	Micro Stevens Scissors	48
Meyhoefer Chalazion Curettes	717	Micro Wire Closure Forceps	678, 679
Mezenbaum-S Scissors with T/C	98	" Greven	678
Michel Laryngeal Mirrors	581	" Juers	678
Michel Modif. Suture Forceps	293	" McGee	678
Michel Suture and Pocket Instrument Set	295	" Schuknecht	678
Michel Suture Forceps	292, 293	Micro-Adson Dressing Forceps	139
Micro Crura Nippers	679	Micro-Adson Tissue Forceps	139
Micro Crura Nippers Mehmke	679	Micro-Adson-Biemer Tissue Forceps	140
Micro Dissectors Hardy	751	Micro-Coron Bulldog Clamps	208
Micro Ear Forceps	674-676	Micro-Halstead Haemostatic Forceps	162
" Mini McGee Alligator	674	Micro-Hartmann Haemostatic Forceps	161
" Wullstein-Blakesley	675	Micro-Slim Needle Holders with T/C	263
Micro Ear Scissors	676, 677	Middeldorpf	340
" Bellucci	676, 677	Middleton Adenoid Curettes	649
" Shea-Bellucci	677	Middleton-Jansen Nasal Cutting Forceps	623
" Wullstein	677	Middleton-Struycen Nasal Cutting Forceps	623
Micro Enucleators Hardy	751	Mikulicz Peritoneal Clamp Forceps	204-206
Micro Forceps	153-157	Mikulicz Intestinal Clamp Forceps	776
Micro Instruments Sterilizing Cases	972	Mikulicz Retractor	320, 353, 354, 373
Micro Introduction Instruments	679	Mikulicz Spatulas	373
" Daval	679	Milan Uterine Curettes	913
" Fuller	679	Milette Tonsil Knives	589
" House-Dieter	679	Miller Bone Files	473
Micro Ligature Guides Yasargil	750	Miller Laryngoscopes	561
Micro Malleus Nippers Lempert	679	Miller Rectal Scissors	801
Micro Malleus Nippers Wullstein	679	Milian-Bacon Bladder Retractor	417
Micro Needle Holders	269-275	Milligan Dura Dissectors	758
" Arruga	269, 272	Milligan Retractor	382
" Barens	269	Millin Bladder Retractor	416, 417
" Barraquer	269, 270	Millin Prostatectomy Atrauma Forceps	871
" Barraquer-Troutman	270	Millin Prostatectomy Forceps	871
" Brock	272	Millison Retractor	382
" Castroviejo with T/C	268	Mills Vascular Scissors	75
" Castroviejo-Kalt	269	Milne-Murray Obstetrical Forceps	963
" Castroviejo	271, 272, 274	Mini McGee Alligator Micro Ear Forceps	674
" Castroviejo-Barraquer	274	Mini Micro Aneurysm and Vessel Clips	753
" Gomel	274	Mini Thoracotomy Rib Spreaders	532
" Jacobson	274, 274	Mini-Freidmann Bone Rongeurs	491
" Jacobson with T/C	268	Mini-Gemini Dissecting and Ligature Forceps	181
" Kalt	269	Mini-Hohmann Bone Levers	465
" Kalt with T/C	268	Mini-Lambotte Bone Osteotomes	442, 443
" Kalt-Arruga	269	Mini-Langenbeck Retractor	326
" Muller	272	Mini-Lexer Bone Gouges	443
" Noyes	270	Mini-Lexer Bone Osteotomes	443
" Paton	271	Mini-Roux Retractor	376
" Potts-Smith	269	Mini-Ryder Needle Holders with T/C	262
" Reill	272	Mini-Townsend Uterine Biopsy Forceps	898
" Rohrschneider	271	Mirror Handles	580, 581
" Stevens	269	Miskimon Retractor	388
" Yasargil	275	Mixer-O'Shaughnessy Bronchus and Gall Duct Clamps	187
Micro Neuro Forceps	751, 752	Mixer Bronchus and Gall Duct Clamps	187, 189
Micro Neuro Knives	749	Mixer Dissecting and Ligature Forceps	183
Micro Neuro Knives Fisch	749	Mixer Gall Stone Forceps	858
" Jacobson	749	Mixer Operating Scissors	64
" Koos	749	Mixer Probes	857
" Kraus	749	Mixer-Baby Dissecting and Ligature Forceps	184
" Yasargil	749	Moberg Bone Osteotomes	437
Micro Neuro Scissors Yasargil	747, 748	Moberg Rhinoplastic Chisel	636

	Page		Page
Mobile Percussion Hammers	17	Moynihan Probes	857
Mod. Berlin Biopsy Curettes	908	Moynihan Stomach Clamp Forceps	779
Mod. Bonn Ophthalmic Hooks	712	Moynihan Towel Forceps	213
Mod. Bonn Ophthalmic Iris Forceps	726, 727	Muck Ear Knives	689
Mod. Hamburg Ophthalmic Knives	708	Muck Tonsil Seizing Forceps	595
Mod. Heidelberg Swab Holders	744	Mueller Retractor	379
Mod. Klinikum Berlin Haemostatic Forceps	172	Muhling Bone Cutters	488
Mod. Klinikum-Berlin Tubing Clamps	210	Muhling Raspatories	457
Mod. Muenchen Biopsy Curettes	908	Muhling Septum Scissors	632
Mod. Tübingen Ophthalmic Hooks	712	Muldoon Lachrymal Dilators	720
Mod. Tübingen Ophthalmic Knives	708	Muldoon Lid Everters	704
Mod. Tübingen Ophthalmic Strabismus Forceps	733	Muller Eye Speculum	703
Mod. USA Bone Curettes	479	Muller Micro Needle Holders	272
Mod. USA Umbilical Scissors	86	Muller Retractor	305
Mod. Wein Nasal Speculum	613	Mulux Tongue Depressors	572
Model Tübingen Retractor	336	Murdock Eye Speculum	703
Moeltgen Measuring Instrument	10	Murless Obstetrical Forceps	960
Mohr Tubing Clamps	969	Murphy Bone Gouges	438
Moldenhauer Foreign Body Instruments	698	Murphy Bone Osteotomes	438
Moldestad Retractor	304	Murphy Retractor	321
Moleskin Plaster Shears	111	Murphy-Lane Bone Levers	471
Molt Bone Files	473	Museux Tonsil Seizing Forceps	595
Molt Mouth Gags	563	Museux Uterine Tenaculum Forceps	879, 883, 884
Molt Raspatories	452	Museux-Palmer Uterine Tenaculum Forceps	884
Moncorps Lucas Curettes	765	Myles Cannula	653
Moore Gall Stone Scoops	862	Myles Nasal Cutting Forceps	624
Moore Hand Drills	539	Myomatome Knives	35
Moorfield Double Instruments	724	Myomatomes	899
Moorfield Ophthalmic Suture Forceps	732		
Moritz-Schmidt Tongue Depressors	572	N	
Morris Atrauma Sigmoid Anastomosis Forceps	793	Naegele Obstetrical Forceps	958
Morris Retractor	352	Naegele Perforators	950
Morris-De Bakey Atrauma Cardiovascular Forceps	820	Nager Ligature Needles	285
Morrison Davies Retractor	355	Nager Tonsil Needles	592
Morse Rib Spreaders	524	Nager Tonsil Retractors	591
Mosquito Haemostatic Forceps	161-163	Nail Excavators	125
Mosquito-Dandy Haemostatic Forceps	162	Nail Files	125
Mounting Frame for Roehard Abdominal Ret.	414	Nail Instruments	518, 519
Moure Adenoid Curettes	651	Nail Knives	123
Mouth Gags	562-569	Nail Nippers	120, 121
" Davis-Boyle	566	Nail Scissors	126, 127
" Denhardt	562	Nail Spatulas	124, 125
" Dingman	567	Nail Splitting Forceps	518
" Doyen-Collin	563	Nasal Cutting Forceps	623, 624
" Doyen-Jansen	563	" Cordes	624
" Featherstone	563	" Gruenwald	624
" Fergusson-Ackland	562	" Hajek-Claus	623
" Heister	563	" Hartmann	623, 624
" Jennings	563-565	" Middleton-Jansen	623
" Kilner-Dott	565	" Middleton-Struycken	623
" Kilner-Doughty	568	" Myles	624
" Kilner-Russel	565	" Ostrom	624
" Mason	562	" Schmeden	623
" Mason-Ackland	562	" Wagener	624
" Mclvor	567	Nasal Knives	625, 626
" Molt	563	" Ballenger	626
" Negus	569	" Bruenings	626
" Oringer	565	" Converse	625
" Roser-Koenig	562	" Cottle	625
" Seemann-Seiffert	565	" Fomon	625
" Seemann-Seiffert (Self-Retaining)	565	" Freer	626
" Whitehead	565	" Halle	626
Mowlem Rhinoplastic Saws	640	" Heymann	625
Moynihan Haemostatic Forceps	166	" Joseph	625
Moynihan Intestinal Clamp Forceps	777		

	Page		Page
Nasal Knives (cont'd)		Needle Holders (cont'd)	
" Krieg	625	" Bozemann	249
Nasal Polypus and Cutting Forceps	621-624	" Bozemann with T/C	264
" Blakesley	621	" Brown	243
" Blakesley (Lewis)	621	" Bruce Clark	244
" Bruenings	621	" Castroviejo with T/C	268
" Luc	621	" Collier	242, 247
Nasal Polypus and Septum Forceps	619-622	" Converse	241, 245
" Craig	620	" Converse with T/C	259, 260
" Craig-Dominick	620	" Crile	250
" Gruenwald (Jansen)	620	" Crile-Murray	243
" Hartmann	619	" Crile-Wood	243
" Heymann	620	" Crile-Wood with T/C	259
" Heymann-Knight	619	" De Bakey with T/C	260
" Killian	619	" Derf	242
" Knight	619	" Derf with T/C	258
" Littauer	619	" Doyen	242
" Lubet-Barbon	619	" Eiselsberg	249
" Noyes	620	" Eiselsberg-Mathieu	255
" Quire	620	" Ermold	256
" Tilley	620	" Finochietto	247
" Troeltsch	620	" Finochietto with T/C	264
" Westmacott	619	" Gillies	249
Nasal Polypus Forceps	622	" Gillies with T/C	265
" Ferris-Smith	622	" Gillies-Slim	249
" Kofler	622	" Gillies-Slim with T/C	265
" Takahashi	622	" Hagedorn	257
" Watson-Williams	622	" Halsey	241
" Weil	622	" Halsey with T/C	258
Nasal Scissors	79, 80, 618	" Halstead	246
" Heymann	618	" Heaney	248
" Jackson	618	" Hegar	241, 244
" Kirstein	618	" Hegar with T/C	261
" Knight	618	" Hegar-Baumgartner	242
" Seiler	618	" Hegar-Baumgartner with T/C	258
Nasal Snares	618	" Hegar-Vascular with T/C	263
" Krause	618	" Hodlick	243
" Krause-Voss	618	" Hoesel	256
" Lange-Wilde	618	" Hoesel with T/C	267
Nasal Speculum	613-618	" Hufnagel	245
" Beckmann	614	" Hufnagel with T/C	262
" Cholewa	618	" Intracardiac with T/C	263
" Cottle	615, 616	" Jacobson with T/C	268
" Fraenkel	617, 618	" Jamison	244
" Hartmann	613	" Janson	246
" Hartmann-Halle	613	" Julian	248
" Killian	615	" Julian with T/C	261
" Mod. Wein	613	" Kader-Mathieu	255
" Patton	617	" Kalt with T/C	268
" Schwarz	613	" Kilner	242
" Sonnenschein	614	" Kilner with T/C	259, 260
" Thudichum (Goldsmith)	617	" Kirschner	250
" Tieck-Halle	616	" Koenig	251
" USA Model	617	" Langenbeck	251
" Vienna	614	" Langenbeck with T/C	268
" Voltolini	617	" Langenbeck-Ryder with T/C	268
" Wiener Model	616, 617	" Lichtenberg	253
" Yankauer	615	" Lichtenberg with T/C	266, 267
Naunton Morgan Needle Holders with T/C	265	" Luethy-Beck	256
Needle Holders	241-257	" Luethy-Beck with T/C	267
" Adson	243	" M. G. H.	244
" Arruga with T/C	267	" Masing with T/C	258
" Axhausen	250	" Masson	246
" Baby-Crile-Wood with T/C	259	" Masson with T/C	264
" Boynton with T/C	267	" Masson-Luethy	246

	Page		Page
Needle Holders (cont'd)		Needle Holders Micro (cont'd)	
" Mathie-Kersten	253	" Gomel	274
" Mathieu	252, 254	" Jacobson	274, 274
" Mathieu-Kocher	252, 254	" Kalt	269
" Mathieu-Kocher with T/C	266	" Kalt-Arruga	269
" Mathieu-Slim with T/C	266	" Muller	272
" Mathieu-Stille	254	" Noyes	270
" Mathieu-Sverige	253	" Paton	271
" Mayo	256	" Potts-Smith	269
" Mayo-Hegar	241	" Reill	272
" Mayo-Hegar (Heaney) with T/C	261	" Rohrschneider	271
" Mayo-Hegar Seeley	243	" Stevens	269
" Mayo-Hegar with T/C	261	" Yasargil	275
" Mayo-Hegar-Seeley with T/C	261	Needles Discission	711
" Metzenbaum	248	" Bowman	711
" Metzenbaum-Mathieu	251	" Schweigger	711
" Metzenbaum-Mathieu with T/C	266	Needles Ear	693
" Micro-Slim with T/C	263	" Barbara	693
" Mini-Ryder with T/C	262	" Rosen	693
" Naunton Morgan with T/C	265	Needles Hypodermic and Biopsy	240
" Neivert	242	" Dattner	240
" New Orleans	248	" Klima-Rosegger	240
" New Orleans with T/C	259	" Strauss	240
" Nivet with T/C	259	Needles Ligature	279-286, 744
" Olsen-Hegar	249, 250	" Brunner	280, 285
" Olsen-Hegar with T/C	265	" Clas-Eicken	285
" Rehbein-Baby	242	" Claus	285
" Rinne	255	" Cooper	280
" Ryder with T/C	262	" Craft	286
" Ryder-Vascular with T/C	262	" Da la Roza	744
" Sarot	244	" Deschamps	281, 282
" Sarot	247	" Dupuy-Weiss	284
" Sarot with T/C	260	" Durham	285
" Schoemaker-Loth	249	" Emmet	284
" Senning	246	" Falk	285
" Senning with T/C	259	" Hessberg	744
" Steinbach	255	" Jacobi	744
" Stille	255	" Jonesco	284
" Stratte	245	" Kocher	280
" Stratte with T/C	263	" Kronecker	280
" Swess Mod.	247	" Langenbeck	283
" Thomson-Walker (Bozemann)	248	" Nager	285
" Toennis	251	" Pauchet	284
" Toennis with T/C	268	" Payr	283
" Wagner	257	" Schmieden Dick	279
" Wangenstein	247	" Schmieden	279
" Wangenstein with T/C	264	" Syme	286
" Webster	241	" Trelat	285
" Webster with T/C	258	" Woodruff	744
" Wertheim	245	" Yankauer	284
" Wertheim	248	" Young	279
" Wertheim with T/C	263	" Young-Hryntschanck	279
" with T/C	258-268	Needles Ophthalmic	710
" Wright (Derf) with T/C	258	" La Force	710
" Zweifel with T/C	267	" Levinson	710
Needle Holders with T/C	258-268	" Swiss Mod.	710
Needle Holders Micro	269-275	Needles Paracentesis	689-692
" Arruga	269, 272	" Buck	689, 690
" Barens	269	" Dench	689
" Barraquer	269, 270	" Dintenfass	689, 690
" Barraquer-Troutman	270	" Friesner	689
" Brock	272	" Gerzog	689
" Castroviejo-Kalt	269	" Gerzog-Sexton	691
" Castroviejo	271, 272, 274	" Jacobsen	690
" Castroviejo-Barraquer	274	" Lempert	691

	Page		Page
Needles Paracentesis (cont'd)		Neuro Knives	749, 762
" Lucae	690	" Bucy	762
" Lucae (Royce)	691	" Fisch	749
" Politzers	689-692	" Frazier	762
" Reiner	689	" Halle	762
" Royce	689, 690	" Jacobson	749
" Sexton	689-691	" Koos	749
" Sprague	692	" Kraus	749
" Troeltsch	691	" Olivecrona	762
Needles Reverdin	276-278	" Toennis	762
" Albaran	277	" Yasargil	749
" Redon	278	Neuro Micro Forceps	751, 752
" Tierny	278	Neuro Scissors Yasargil	747, 748
Needles Rhinoplastic Yankauer	638	Neuro Separators Woodson	762
Needles Storing Cases	972	Neurosurgical Scissors	78
Needles Tonsil	592-594	New Orleans Needle Holders	248
" Alexander	594	New Orleans Needle Holders with T/C	259
" Clas-Eicken	593	New Orleans Ophthalmic Scoops	715
" Dupuy-Weiss	592	Newman Rectal Specula	798
" Durham	593	News Retractor	306
" Eicken	593	Nicaise Scarifying Knives	35
" Falk	593	Nicati Ophthalmic Chisels	710
" Henton	592	Nicola Pituitary Curettes	760
" Hurd	593	Nippers	120-122
" Nager	592	Nippers Micro Crura	679
" Rotter	593	Nippers Micro Crura Mehmke	679
" Trelat	592	Nippers Micro Malleus Lempert	679
" Walker	593	Nippers Micro Malleus Wullstein	679
Negus Haemostatic Forceps	178	Niro Bone Cutters	485
Negus Laryngoscopes	559	Nissen Dissecting and Ligature Forceps	181
Negus Mouth Gags	569	Nissen Gall Duct Forceps	856
Neivert Rhinoplastic Chisel	636	Nissen Rib Spreaders	528
Neivert Rhinoplastic Hooks	637	Nivet Needle Holders with T/C	259
Neivert Needle Holders	242	Norwood Swab Holder for Rectum	807
Nelaton Anatomy and Post Mortem Knives	38	Noto Dressing and Sponge Holding Forceps	219
Nelson Tissue Forceps	141	Noto Uterine Dressing Forceps	887
Nelson Trocars	232	Nott Vaginal Speculum	926
Nelson-Standard Trocars	230	Novak Biopsy Curettes	907
Neonatal and Pediatric Clamps	837-840	Novak-Schoeckaert Biopsy Curettes	907
" Castaneda	840	Noyes Micro Needle Holders	270
" Cooley	838, 839	Noyes Nasal Polypus and Septum Forceps	620
" Subramanian-Miniature	837	Noyes Ophthalmic Iridectomy Scissors	742
Nerve Hooks	759, 760	Noyes Ophthalmic Micro Scissors	740
" Crile	849	Nuboer Suction Tubes	238
" Dandy	759	Nuemann Gum Scissors	86
" Krayenbuhl	749	Nugent Ophthalmic Strabismus Forceps	733
" Scoville	760	Nurses Scissors Flat Shanks	58
" Smithwick	759, 760	Nurses Scissors Round Shanks	56, 57
Nerve Root Elevators	763, 764	Nurses Scissors Slim Pattern	59
" Love	764	Nurses Scissors with T/C	100, 101
" Oldberg	764		
" Scoville	764	O	
" Taylor	764	O'Conner Retractor	303
Nerve-Preparation Dissecting Scissors	65	O'Brien Ophthalmic Fixation Forceps	729
Nett Meniscectomy Knives	427	O'Brien Suture Scissors	294
Neubuser Tubal Seizing Forceps	899	Obstetrical Forceps	958-964
Neumann Scissors	47	" Anderson	962
Neuro Douflex Mod. Dejerine Percussion Hammer	19	" Bailey-Williamson	961
Neuro Elevators	761	" Barens	962
" Cushing	761	" Barnes-Neville	964
" Dandy	761	" Barton	962
" Hoen	761	" Boerma	958
Neuro Hooklets	765	" De Lee	961
" Gillies	765	" Demelis	963
" Kilner	765		

TABLE OF CONTENTS

	Page		Page
Obstetrical Forceps (cont'd)		Operating Scissors	56-64
" Deweys	964	Ophthalmic Advancement Forceps	736
" Elliot	963	" Barens	736
" Haig-Fergusson	963	" Elschmig	736
" Hawks-Dennen	961	" Worth	736
" K. N. Dass	962	Ophthalmic Anterior Chamber Forceps Barraquer	735
" Kielland	960	Ophthalmic Capsular Forceps	729-732
" Kielland-Luikart	960	" Arruga	730
" Luikart	960	" Arruga-Nizetic	730
" Mc Lean	960	" Barraquer	731
" Mc Lean-Luikart	961	" Binkhorst	732
" Mc Lean-Rucker-Luikart	961	" Castroviejo	730
" Milne-Murray	963	" Choyce	731
" Murless	960	" Clayman	731
" Naegele	958	" Elschmig	730
" Piper	959	" Foerster	729
" Simpson	958, 963	" Fuchs	730
" Simpson-Braun	959	" Galin	731
" Simpson-Luikart	959	" Gill-Arruga	729
" Tarnier	964	" Gill-Fuchs	729
" Wrigley	958	" Green	731
Obwegesser Channelled Retractors	577	" Hess	730
Obwegesser Chin Retractors	577	" Hirschmann	732
Obwegesser Ramus Retractors	577	" Kalt	730
Obwegesser Retractor	337	" McPherson	731
Obwegesser Awls	586	" Pley	730
Obwegesser Bone Osteotomes	444	" Safar	731
Obwegesser Elevators	462, 463	" Schweigger	729
Ochsner Atrauma Cardiovascular Forceps	829	" Shepard	731
Ochsner Dressing Forceps	132	" Stock	729
Ochsner Probes	857	" Swiss Mod.	729
Ochsner Suture Forceps	292	" Terson	729, 731
Ochsner Trocars	232	Ophthalmic Chisels	710
O'Conner Ophthalmic Hooks	712	" Green	710
Oehler Tissue Forceps with T/C	158	" Knapp	710
Oelert Sternum Retractors	523	" Nicati	710
Oettingen Abdominal Retractor	404	" Rollet	710
Ogura Rhinoplastic Forceps	644	Ophthalmic Corneal Scissors Castroviejo	742
Oldberg Nerve Root Retractors	764	Ophthalmic Curettes	710
Oldberg Rongeurs	664	" Abadie	710
Olivecrona Amputation Saws	119, 754	" Alvis	710
Olivecrona Bone Rongeurs	496	" Davis	710
Olivecrona Brain Spatulas	763	" Ellis	710
Olivecrona Dura Dissectors	758	" Francis	710
Olivecrona Neuro Knives	762	" Plange	710
Olivecrona Neurosurgical Scissors	78	Ophthalmic Cycloclodialysis Spatulas	714
Olivecrona Trigeminal Knives	34	" Culler	714
Olivecrona-Toennis (Scoville) Clip Applying Forceps	754	" Stock	714
Olivecrona Raspatories	457	" Suker	714
Ollier Retractor	320, 322, 323	" Weber	714
Ollier-Collin Retractor	323	" Wecker	714
Olsen-Hegar Needle Holders	249, 250	Ophthalmic Cystotomes	713
Olsen-Hegar Needle Holders with T/C	265	" Graefe	713
Olshausen Vaginal Retractors	942	" Meyer-Schwickerath	713
Ombredanne (Jackhson) Towel Forceps	212	Ophthalmic Dissectors	718
Ombredanne Mallet	421	" Axenfeld	718
Operating Scalpels	25-32	" Lang	718
" Adams	32	Ophthalmic Enucleation Scissors	743
" Bergmann	30	" LaGrange	743
" Collin	31	" McGuire	743
" Dieffenbach	26, 30, 32	" Spencer	743
" Farabeuf	25	Ophthalmic Expression Forceps	736
" Halle	29	" Knapp	736
" Parker	32	" Prince	736
" Simon	31	Ophthalmic Fixation Forceps	727-729, 736

	Page		Page
Ophthalmic Fixation Forceps (cont'd)		" Gill-Hess	727
" Barraquer	728	" Graefe	725
" Barraquer (Colibri)	727	" Hess	726
" Barraquer-Katzin	727	" Mod. Bonn	726, 727
" Barraquer-Katzin (Colibri)	727	" Panas	726
" Barraquer-Llovera	728	" Stevens	725
" Castroviejo	727	Ophthalmic Keratomes	707
" Castroviejo-Colibri	728	" Barens	707
" Clark-Verhoeff	729	" Castroviejo	707
" Dermor-Pierse	736	" Jaeger	707
" Dermor-Pierse (Colibri)	736	" Jaeger-Grieshaber	707
" Elschmig	728	" Papst	707
" Graefe	728	" Rowland	707
" Green	728	" Weeker	707
" Kirby-Artur	728	" Weiner	707
" Maumenee-Colibri	728	Ophthalmic Knives	705-710
" O'Brien	729	" Anderson-Critchett	709
" Pierse	728	" Axenfeld	709
" Pierse-Colibri	728	" Barens	707
" Sauer	728	" Barkan	709
" Troutman (Colibri)	727	" Barraquer	706, 709
" Verhoeff	729	" Beer	706
" Waldau	729	" Berens	706
" Willard-Colibri	729	" Blascovics	709
Ophthalmic Forceps	725-738	" Bowman	708
Ophthalmic Gouges	710	" Burch	709
" Dix	711	" Castroviejo	706
" Kuhnt	710	" Castroviejo	707
" Meyer	710	" Curdy	709
" Walton	710	" Daily	709
" Walton (Todd)	710	" Dean	709
Ophthalmic Hooklets	712	" Desmarres	709
" Arruga	712	" Deutschmann	706
" Culler	712	" Elschmig	709
" Graefe	712	" Gill	709
" Green	712	" Girard Swan	710
" Jameson	712	" Graefe	706, 708, 709
" Smith	712	" Graefe-Arruga	706
" Stevens	712	" Guthrie	709
Ophthalmic Hooks	712	" Guyton-Lundsgaard	709
" Berens	712	" Haab	709
" Graefe	712	" Jaeger	707
" Guthrie	712	" Jaeger-Grieshaber	707
" Hirschmann	712	" Johnson	708, 709
" Holth	712	" Johnson-Took	709
" Mod. Bonn	712	" Knapp	708
" Mod. Tubingen	712	" Kuhnt	708
" O'Conner	712	" Lundsgaard	709
" Panas	712	" McReynolds	709
" Stevens	712	" Mod. Hamburg	708
" Tyrel	712	" Mod. Tubingen	708
" Wiener	712	" Papst	707
Ophthalmic Iridectomy Scissors	742	" Paton	709
" Castroviejo	742	" Paufigue	709
" Noyes	742	" Rowland	707
" Scheie-Westcott	742	" Sato	708
Ophthalmic Iris Forceps	725-727	" Scheie	709
" Bishop-Harman	725	" Schmith-Green	706
" Chandler	727	" Schnaudigl	708
" Elliot	726	" Searcy	709
" Fischer	726	" Sichel	708
" Fischer-Artl	726	" Took	709
" Foerster	726	" Troutman	710
" Fuchs	727	" Walker-Lee	709
" Gill	727	" Weber	708

TABLE OF CONTENTS

	Page		Page
Ophthalmic Knives (cont'd)		Ophthalmic Scoops (cont'd)	
" Weeker	707, 709	" Wells	715
" Weiner	707	Ophthalmic Skeleton Forceps Kuhnt	736
" Wheeler	706	Ophthalmic Spatulas	714
" Ziegler	708	" Castroviejo	714
Ophthalmic Lens Expressors	713	" Dastoor	714
" Amenabar	715	Ophthalmic Speculum	702, 703
" Barens	713	" Agricola	703
" Wilmer-Bagley	713	" Arruga	703
Ophthalmic Micro Scissors	738-743	" Axenfeld	703
" Aebli	739	" Barraquer (Colibri)	702
" Barraquer	738	" Bowman	702
" Castroviejo	739	" Cook	703
" Katzin	739	" Critchett	702
" Katzin-Barraquer	739	" Goldstein	703
" McClure	740	" Graefe	702
" McPherson-Vannas	741	" Guyton-Park	703
" Micro	740	" Knapp-Clark	702
" Noyes	740	" Lancaster	702
" Troutman	738	" Lister-Burch	702
" Troutman-Barraquer	739	" Mellinger	703
" Troutman-Castroviejo	738, 740	" Mellinger-Axenfeld	703
" Vannas	741	" Mellinger-Beard	703
" Vannas Mod. Tubingen	741	" Muller	703
" Wecker	740	" Murdock	703
Ophthalmic Muscular Forceps	734, 735	" Park	703
" Berke	735	" Park-Maumenee	703
" Blascovics	735	" Pley	702
" Fink-Jameson	735	" Sauer	702
" Jameson	734	" Stevenson	703
" Prince	735	" Weiss	702
" Sattler	735	" Ziegler	702
Ophthalmic Needles	710	Ophthalmic Spud	710, 711
" La Force	710	" Luer	710
" Levinson	710	" Standard	710
" Swiss Mod.	710	Ophthalmic Strabismus Forceps	733, 734
Ophthalmic Orbit Spatulas Sautter	713	" Barraquer Modif.	733
Ophthalmic Radial Keratotomy Forceps	737	" Bonaccolto	733, 734
" Arrowsmith	737	" Bonn	733
" Bores	737	" Dastoor	734
" Kremer	737	" McCullough	733
" Rubman-Bores	737	" McPherson	734
Ophthalmic Rasps	714	" Mod. Tubingen	733
Ophthalmic Retractors	713	" Nugent	733
" Arruga	713	" Paufigue	734
" Aubaret	713	" Schaaf	734
" Axenfeld	713	" Truthman-Rectus	734
" Fink	713	" Tubingen	733
" Knapp	713	Ophthalmic Suture Forceps	732, 733
" McGannan	713	" Alabama-University	732
" Pauls	713	" Castroviejo	733
" Rollet	713	" Dastoor	733
Ophthalmic Scoops	715	" Falcao	732
" Art	715	" Girad	733
" Daviel	715	" Guist	732
" Elschmig	715	" Kronfeld	732
" Graefe	715	" Kronfeld (Panas)	732
" Hess	715	" Moorfield	732
" Knapp	715	Ophthalmic Tenotomy Scissors	741
" Lewis	715	" Castroviejo	741
" New Orleans	715	" Fine	741
" Snellen	715	" McPherson-Westcott	741
" Troutman	715	" Westcott	741
" Verhoeff	715	Ophthalmic Tissue Forceps	732
" Weber	715	" Lester	732

	Page		Page
Ophthalmic Tissue Forceps (cont'd)		Papillotomes	863
" Schmidt-Rimpler	732	Pappen-Blalock Atrauma Aortic Clamps	841
Ophthalmic Trephines	721, 722	Papst Ophthalmic Keratomes	707
" Arruga	721	Papst Ophthalmic Knives	707
" Castroviejo	721, 722	Paracentesis Needles	689-692
" Elliot	721	" Buck	689, 690
" Grieshaber	721	" Dench	689
" Stephenson	721	" Dintenfass	689, 690
Ophthalmology Operating Sets	745, 746	" Friesner	689
Ophthalmoscope Set	14	" Gerzog	689
Organ Holding Forceps	179, 180	" Gerzog-Sexton	691
" Chaput	179	" Jacobsen	690
" Collin	179	" Lempert	691
" Tuffier	179	" Lucae	690
Original Steinhauser Instruments	669, 670	" Lucae (Royce)	691
Original-Jackson Broncho-Esophagoscopy Forceps	601, 603	" Politzers	689-692
Oringer Mouth Gags	565	" Reiner	689
Osteotomes Bone	434-447	" Royce	689, 690
" Bergmann	441	" Sexton	689-691
" Brunetti	442	" Sprague	692
" Cottle	438	" Troeltsch	691
" Hibbs	436, 437	Parametrium Scissors with T/C	99
" Hoke	436	Parham Bone Wire Guides	548
" Lambotte	439, 443	Park Eye Speculum	703
" Lexer	444, 447	Park Rectal Specula	797
" Mannerfelt Modif.	435	Parker Operating Scalpel	32
" Mini-Lambotte	442, 443	Parker Retractor	377
" Mini-Lexer	443	Parker-Kerr Intestinal Clamp Forceps	776
" Moberg	437	Parker-Langenbeck Retractor	377
" Murphy	438	Parker-Mott Retractor	377
" Obwegesser	444	Park-Maumenee Eye Speculum	703
" Sheehan	438	Parry-Cooley Atrauma Cardiovascular Forceps	834
" Smith-Petersen	442	Partsch Bone Chisels	435
" Stille	440	Partsch Intestinal and Stomach Clamp Forceps	780
" U. S. Army	439	Partsch Mallet	423
" Virchow	441	Partsch Mod. Lange Raspatories	451
Osteotomes Rhinoplastic	634, 635	Partsch Raspatories	451
" Cottle	634, 635	Passow Tampers	448
" Sheehan	635	Paton Micro Needle Holders	271
" Walter	634	Paton Ophthalmic Knives	709
Ostrom Nasal Cutting Forceps	624	Paton Transplant Forceps	721
O-Sullivan-O'Conner Abdominal Retractor	409	Patton Nasal Speculum	617
O-Sullivan-O'Conner Vaginal Speculum	941	Pauchet Ligature Needles	284
Otoscopes	12-14	Paufique Ophthalmic Knives	709
Overholt Dissecting and Ligature Forceps	181	Paufique Ophthalmic Strabismus Forceps	734
Overholt-Geissendoerfer Dissecting and Ligature Forceps	185	Paul Retractor	309
Overholt-Mixter Dissecting and Ligature Forceps	182	Pauls Ophthalmic Retractors	713
Ovum and Placenta Forceps	944-950	Paulsen Raspatories	453
" Corey	950	Payr Ligature Needles	283
" Kelly	948	Payr Intestinal and Stomach Clamp Forceps	780
" Kranz	950	Payr Ligature Conductors	289
" Lewkowitz	949	Payr-Baby Intestinal and Stomach Clamp Forceps	780
" Mc Clintock	948	Pean Haemostatic Forceps	169, 171, 172
" Saenger	949	Pean Trocars	232
" Winter	944-948	Pean-Dixon Haemostatic Forceps	169
Ovum Curettes	952	Pean-Nippon Haemostatic Forceps	170
" Cuzzi	952	Pederson Vaginal Speculum	920
" Pestalozza	952	Pediatric and Neonatal Clamps	837-840
		" Castaneda	840
P		" Cooley	838, 839
Palmer Fracture Pins	545	" Subramanian-Miniature	837
Panas Ophthalmic Hooks	712	Peers-Bertram Towel Forceps	212
Panas Ophthalmic Iris Forceps	726	Peet Splinter Forceps	147
Paparella Ear Speculum	682	Peiper-Beyer Bone Rongeurs	498
		Pelkmann Dressing and Sponge Holding Forceps	220

	Page		Page
Pelkman Gall Stone Forceps	859	Pituitary Curettes	760, 761
Pelkman Uterine Dressing Forceps	886	" Cone	761
Pelvimeters	954, 955	" Nicola	760
" Breisky	955	" Ray	760
" Collin	954	Placenta and Ovum Forceps	944-950
" Collyer	955	" Corey	950
" De Lee	954	" Kelly	948
" Schneider	954	" Kranz	950
" Thole	955	" Lewkowitz	949
Pelvis Retractors	800	" Mc Clintock	948
Penfield Dura Dissectors	757, 758	" Saenger	949
Penis Clamps	871, 872	" Winter	944-948
Penner Nail Forceps	519	Placenta Pan	988
Pennington Septum and Periosteal Elevators	629	Placenta Plate	988
Percussion Hammers	16-19	Plange Ophthalmic Curettes	710
" Babinski	16	Plaster Breakers	112
" Berliner	18	" Farabeuf	112
" Buck	17	" Mason	112
" Dajerine	18	" Wolff	112
" Drivers Douflex Mod. Dejerine	19	Plaster Knives	114
" Ebstein	18	" Esmarch	114
" Mobile	17	" Hopkins	114
" Neuro Douflex Mod. Dejerine	19	" Korte	114
" Rabiner	16	" Reiner	114
" Taylor	17	Plaster Lifter	115
" Troemner	19	" Kaulich	115
" Traube	18	" Wigmore	115
" Troemner Simplex	19	Plaster Shears	109-111
" Vernon	17	" Bruns	111
Perforators Naegele	950	" Commander	110
Perforators Smellie	950	" Guy	111
Perham Bone Holding Clamp Forceps	517	" Haglund-Stille	111
Periosteal Elevators	627-631	" Hercules	111
" Cottle	631	" Moleskin	111
" Cottle-McKenty	631	" Seutin	110
" Killian	631	" Stille	109, 110
Peritoneal Clamp Forceps	204-206	" Stille-Mini	109
" Baby-Mikulicz	204	Plaster Spreaders	113
" Faure	205	" Beeson	113
" Mikulicz	204-206	" Haglund-Stille	113
" Schindler	206	" Henning	113
Perkins Retractor	384	" Knorr	113
Perman Abdominal Retractor	405	" Walton	113
Perman Bone Holding Forceps	505	Plate Scissors	55
Perthes Hand Drills	540	Playfair Cotton Holders	901
Pertuiset Carotid Clamps	855	Plester Ear Knives	688
Pess Lid Everters	704	Plester Retractor	383
Pestaloza Ovum Curettes	952	Plester Suction Tubes	236
Peterson Broncho-Esophagoscopy Forceps	602	Pley Eye Speculum	702
Petri Dishes	983	Pley Ophthalmic Capsular Forceps	730
Phaneuf Hysterectomy Forceps	193	Pliers Flat Nose	549-551
Phillip Cotton Dispenser	989	Pliers Steinhauser	670
Phillips Cilia Forceps	150	Pliers Wire Cutting	552-555
Phillips Screw Drivers	542, 543	" Angle	552
Physician Splinter Forceps	148	" Reill	553
Picks Ear Barbara	693	" with T/C	554, 555
Pierce Septum and Periosteal Elevators	628	Pocket Instrument Set	295-297
Pierce Trocars	230	Politzer Ear Knives	689
Pierse Ophthalmic Fixation Forceps	728	Politzer Ear Speculum	680
Pierse-Colibri Ophthalmic Fixation Forceps	728	Politzers Paracentesis Needles	689-692
Piffard Lucas Curettes	765	Polloson Retractor	361
Pinard Stethoscope	8	Polypus Ear Forceps	672, 673
Piper Obstetrical Forceps	959	" Bellucci	672
Pitha Dressing and Washing Forceps	222	" Buck	672
Pitha Foreign Body Forceps	874	" Hartmann	672, 673

	Page		Page
Polypus Ear Forceps (cont'd)		Probes Trabecular (cont'd)	
" Hartmann-Noyes	673	" Harms	719
" Hartmann-Weingartner	673	" Mackensen	719
" Hartmann-Wullstein	673	Proctoscopes	798, 799
" Littauer	672	Prostatic Retractors	869, 870
" Mirco	673-676	" Proust	870
" Quire	672	" Young	869, 870
" Struempel	673	Prostectomy Atrauma Forceps Millin	871
Pool Suction Tubes	234	Prostectomy Forceps	871
Poppen Suction Tubes	235	" Millin	871
Post Mortem Knives	36-40	Proust Prostatic Retractors	870
Pott (Johns-Hopkins) Aorta Clamps	849	Providence-Hospital Haemostatic Forceps	163
Pott Anatomy and Post Mortem Knives	38	Punch Forceps	597
Potts Atrauma Cardiovascular Forceps	821, 822	" Hartmann	597
Potts Sternum Scissors	523	" Ruault	597
Potts Vessel Clamps	854, 855	" Ruault-Collin	597
Potts-De Martel Scissors with T/C	102	" Schmeden	597
Potts-De Martel Vascular Scissors	75	Punches	654-662
Potts-Glover Vessel Clamps	854	" Beyer	657
Potts-Satinsky Vena Cava Clamps	852	Punches Canaliculus	722
Potts-Satinsky Vessel Clamps	855	" Haitz	722
Potts-Smith Aorta Clamps	849	" Holth	722
Potts-Smith Dressing Forceps	135	" LaGrange	722
Potts-Smith Dressing Forceps with T/C	159	Punches Citelli	657
Potts-Smith Micro Needle Holders	269	Punches Colclough	659, 660
Potts-Smith Scissors with T/C	88	Punches Colclough (Richter)	659
Potts-Smith Tissue Forceps	135	Punches Dermal Keys	766
Potts-Smith Vascular Scissors	72, 855	Punches Ferris-Smith	662
Powder Blower Kabierske	701	Punches Ferris-Smith-Kerrison	654-656
Pozzi Uterine Tenaculum Forceps	878, 881	Punches Hajek-Kofler	657, 658
Pozzi-Palmer Uterine Tenaculum Forceps	881	Punches Kerrison	654-656
Pratt Haemostatic Forceps	169	Punches Kofler	658
Pratt Rectal Probes	803	Punches Schlesinger	661
Pratt Rectal Specula	797	Punches Sybert	662
Pratt Rhinoplastic Sharp Curettes	647	Puncturing Forceps	952
Pratt Uterine Dilators	905	" Herff	952
Pratt Uterine Tenaculum Forceps	880	" Iowa	952
Pratt-Smith Haemorrhoidal Forceps	800	Putti Bone Files	474
Price-Thomas Bronchus Forceps	536	Pye-Smith (Harrison) Sterilizing Forceps	966
Prince Cauteries	714		
Prince Ophthalmic Expression Forceps	736	Q	
Prince Ophthalmic Muscular Forceps	735	Quervain Abdominal Retractor	405
Prince Tonsil and Nasal Scissors	80	Quervain Bladder Retractor	416
Probes	857	Quervain Bone Levers	464
" Desjardins	857	Quervain Rib Spreaders	533
" Hajek	857	Quinby Scissors	47
Probes Lachrymal	719, 720	Quire Ear Polypus Forceps	672
" Bowmann	719, 720	Quire Nasal Polypus and Septum Forceps	620
" Bowmann (Williams)	720	Quisling Rhinoplastic Hammers	647
" Galezowsky	720		
" Rolf	719	R	
" Ziegler	719	Rabiner Percussion Hammer	16
Probes Mayo	857	Ragnell (Kilner) Scissors with T/C	87
Probes Micro	750	Ragnell Dissecting Scissors	69
" Jacobson	750	Ragnell-Davis Retractor	308
" Yasargil	750	Ralk (Virtus) Splinter Forceps	147
Probes Mixer	857	Ralk Hand Drills	539
Probes Moynihan	857	Ralk Splinter Forceps	147
Probes Ochsner	857	Ramplery Dressing and Sponge Holding Forceps	217
Probes Rectal	803	Ramsay Dressing Forceps	132
" Brodie	803	Ramsay Tissue Forceps	132
" Buie	803	Ramus Retractors	577
" Lockhart-Mummery	803	Randall Biopsy Curettes	907
" Pratt	803		
Probes Trabecular	719		

TABLE OF CONTENTS

	Page		Page
Randall Kidney Stone Forceps	864, 865	Razor Blade Removing Forceps	24
Raney Clip Applying Forceps	754	Razors	42
Rankin-Crile Haemostatic Forceps	164	Reamer Forceps Adson	540
Rankin-Kelly Haemostatic Forceps	164	Recamier (Sims) Uterine Wash Curettes	916
Rasmus Retractor	338	Recamier Uterine Curettes	909, 910
Raspatories	449-460	Rectal Cannulas Katzenstein	807
" Adson	457	Rectal Probes	803
" Alexander	455	" Brodie	803
" Bristow	458	" Buie	803
" Buchs	460	" Lockhart-Mummery	803
" Caspar	457	" Pratt	803
" Cobb	460	Rectal Scissors	801
" Cohen	453	" Lloyd-Davis (Goligher's)	801
" Cottle	454, 456	" Miller	801
" Cushing	450, 452	" Stelzner	802
" Doyen	456	Rectal Specula	795-799
" Ear Lempert	700	" Barr	797
" Farabeuf	449	" Bensaude	798
" Farabeuf-Collin	449	" Brinkerhoff	797
" Freer	452, 453	" Cook	795
" Freer-Yasargil	453	" Czerny	795
" Halle	452	" Hirschmann	798
" Hoehn	450	" Ives-Fransle	798
" Howarth	454	" Kelly	799
" Hylin	457	" Killian	795
" Jansen	460	" Mathieu	795
" Joseph	452	" Newman	798
" Kahre-Williger	450	" Park	797
" Key	458	" Pratt	797
" Killian	453	" Ricord	795
" Kirmission	451	" Roschke	795
" Koenig	451	" Schulze-Bergmann	796
" Kramer	455	" Sims	796
" Lambotte	449	" Smith-Buie	797
" Landolt	456	Redon Reverdin Needles	278
" Langenbeck	451	Reese Ophthalmic Trachoma Forceps	736
" Lempert	454	Rehbein (Mod. Bremen) Rib Spreaders and Contractors	535
" MacDonald	453	Rehbein-Baby Needle Holders	242
" Mannerfelt Modif.	458	Rehn Retractor	360
" Mathieu	457	Rehn Skin Grafting Knives	43
" Matson	458	Reichert Epiglottis Retractors	583
" McKenty	449	Reich-Nechtow Biopsy Curettes	907
" Mead	452	Reiger-Sprague Stethoscope	7
" Micro Yasargil	750	Reill Bone Holding Forceps	504
" Molt	452	Reill Micro Needle Holders	272
" Muhling	457	Reill Wire Cutting Pliers	553
" Olivecrona	457	Rein Atrauma Cardiovascular Forceps	828
" Partsch	451	Reiner Paracentesis Needles	689
" Partsch Mod. Lange	451	Reiner Plaster Knives	114
" Paulsen	453	Reinhoff-Finochietto Rib Spreaders	527
" Schneider	454	Resano Atrauma Sigmoid Anastomosis Forceps	792
" Schneider-Sauerbruch	454	Resano Vascular Scissors	77
" Sedillot	451	Retractors	298-419
" Seldin	454	" Adson	305, 386, 387, 389, 390
" Semb	455	" Adson-Baby	385
" Sewall	452	" Agricola	379
" Trelat	451	" Albarran	357
" Wagner	459	" Allison	370
" Williger	450	" Allison Spatulas	370
Rasps Ophthalmic	714	" Allport	380
Raverdino Lachrymal Dilators	720	" Alm	380
Ray Kidney Stone Forceps	865	" Anal	797, 798
Ray Pituitary Curettes	760	" Anderson-Adson	384
Rayne Retractor	338	" Aorta Cooley	850
Razor Blade Holder and Breakers	24	" Arruga	713

	Page		Page
Retractors (cont'd)		Retractors (cont'd)	
" Aubaret	713	" Finsen	379, 608
" Aufricht	638	" Finsen Modif.	608
" Axenfeld	713	" Fisch	304
" Baby-Collin	401	" Fomon	311
" Baby-Roux	375	" Frazier	305
" Baby-Senn-Miller	308	" Freer	304, 638
" Backmann-Eaton	390	" Fritsch	350, 351
" Barraquer	379	" Gelpi	397, 942
" Barsky	306	" Gelpi-Baby	396
" Beckmann	390	" Gelpi-Loktite	396, 397
" Beckmann-Adson	391	" Gelpi-Seileitz	396
" Beckmann-Bayonet	392	" Genito-Urinary	871, 872
" Bellucci	384	" Genito-Urinary Stockmann	871
" Bergmann	303	" Genito-Urinary Strauss	872
" Billroth	325	" Genito-Urinary Young	871
" Bladder Hryntschak	869	" Gifford-Jansen	381
" Blount	333	" Gillies	304
" Bose	303, 379, 608	" Gil-Vernet	299
" Breisky	351	" Goelet	352
" Brom	307	" Goodyear	591
" Brunner	355-358	" Graefe	303, 307
" Buchs	341	" Greene	341
" Buckley	379	" Guthrie	303
" Canny Ryall	369	" Haberer	374
" Caspar	307, 342	" Handte	301
" Charnley	393	" Harrington	343, 362, 363
" Cheek and Lip	572, 573	" Harrington-Baby	362
" Cheek and Lip Shuman	573	" Harrington-Pemberton	362
" Cheek and Lip Sternberg	572	" Harvey Jackson	391
" Cloward	385, 388, 398, 399	" Heaney	338, 942
" Cloward Modif.	398	" Henley	388
" Cloward-Hoen	400	" Henner (Lempert)	381
" Cloward-Lumber	400	" Hibbs	336
" Collin	377, 402	" Hoen	400
" Collin-Hartmann	378	" Hoesel	346
" Collin-Loktite	402	" Hofer	591
" Converse	305, 638	" Holmann	368
" Cooley	367	" Holzbach	403
" Cope	308	" Howell	326
" Coryllos	359, 360	" Humby	306
" Cottle	299, 303, 635, 637	" Inge	401
" Courty	392	" Intra Oral Retractors	574-576
" Courty-Fontaine	392	" Israel	322
" Crawford	346	" Iterson	607
" Crile	302, 305, 375	" Jackson	303, 308, 609
" Crotti	393	" Jackson Burrows	396
" Cushing	298, 299, 306	" Jaeger	305
" Cushing Kocher	299, 301	" Jansen	381
" Czerny	333, 376	" Joll (Friedman)	397
" Darling	395	" Joll (Friedman)	942
" Dartigues	395	" Joseph	304
" Davidson	363	" Kader	372
" De Bakey	396	" Kallmorgen	940
" Deaver	364-367	" Kelly	348, 353
" Deaver-Baby	366	" Kilner	304, 305, 638
" Desmarres	300	" Kirsch	342
" Dockhorn	344	" Klapp	313
" Doyen	349, 351, 352, 942	" Kleinert-Kutz	306
" Doyen-Stille	343	" Knapp	309, 310, 713
" Emmet	304	" Knighton	394, 399
" Epiglottis Reichert	583	" Kocher	301, 314, 318-320, 330, 334, 344, 374, 393
" Farabeuf	376	" Kocher-Langenbeck	331
" Farr	395	" Kocher-Wagner	345
" Fink	713	" Koenig	300

	Page		Page
Retractors (cont'd)		Retractors (cont'd)	
" Korte	371, 317	" Oelert	523
" Korte-Wagner	319	" Ollier	320, 322, 323
" Kramer	342	" Ollier-Collin	323
" Krayenbuhl	307	" Olshausen	942
" Kristeller	935-938	" Parker	377
" Kristeller (Wiener Modl)	939	" Parker-Langenbeck	377
" Kuemmel	371	" Parker-Mott	377
" Kuttner	380	" Paul	309
" Lahey	326, 333	" Pauls	713
" Lahey Clinic	305	" Perkins	384
" Lampert	318	" Plester	383
" Lancaster	380	" Polloson	361
" Landon	940	" Proust	870
" Lane	376	" Ragnell-Davis	308
" Lange	304	" Rasmus	338
" Langenbeck	327-329, 332, 337	" Rayne	338
" Langenbeck Mannerfelt Modif.	301	" Rehn	360
" Langenbeck-Green	326	" Reverdin	374
" Langenbeck-Mannerfelt Modif.	326	" Ricard	403
" Legueu	344	" Richardson	347, 348
" Leriche	372	" Richardson-Eastman	347
" Lid	704	" Richter	397, 942
" Lid Conway	704	" Robb-Lewis	591
" Lid Desmarres	704	" Rollet	310, 713
" Lid Groenholm	704	" Rose	302, 345, 376, 609
" Little	301	" Rowe	338
" Logan	379	" Rugby	389
" Lothrop	591	" Sauer	380
" Love	302, 591	" Sauerbruch	328, 332, 358
" Love (Morse)	302	" Scalp Contour	383
" Lucae	306	" Schoenborn	301, 608
" Luer	302, 308, 375, 609	" Schulz	342
" Lukens	308, 609	" Seidl	938
" Machatt	310	" Semb	333
" Mannerfelt Modif.	300, 301, 308-310	" Senn-Green	308
" Markham-Meyerding	394	" Senn-Miller	308
" Masing	298, 637	" Sexton	393
" Mathieu	376	" Shambaugh	381
" Mayo-Adams	386, 395	" Simon	304, 335, 941
" Mayo-Collin	377	" Smillie	336
" McGannan	713	" Sofield	378
" Meillinger	380	" Spatulas Allison	370
" Meyerding	313, 339, 394	" St. Marks	369
" Middeldorpf	340	" Steinhauer	669, 670
" Mikulicz	320, 353, 354, 373	" Sternberg	378
" Milligan	382	" Stevenson	381
" Millison	382	" Straight	305
" Mini-Langenbeck	326	" Strandell-Stille	313
" Mini-Roux	376	" Toennis	304
" Miskimon	388	" Tubinger Mod.	386, 941
" Model Tubingen	336	" Tuffier	344, 374
" Moldestad	304	" Venenhaken Brom	313
" Morris	352	" Volkmann	311, 314-317
" Morrison Davies	355	" Wagner	307
" Mueller	379	" Wagner-Jansen	381
" Muller	305	" Wassmund	320
" Murphy	321	" Weedra	607
" Neger	591	" Weinberg	359
" News	306	" Weitlaner	383-385
" O'Conner	303	" Weitlaner-Baby	382
" Obwegeser	337	" Weitlaner-Beckmann	389
" Obwegeser Channelled	577	" Weitlaner-Loktite	382
" Obwegeser Chin	577	" Weitlaner-Original	383
" Obwegeser Ramus	577	" Weitlaner-Wulstein	382

TABLE OF CONTENTS

	Page		Page
Retractors (cont'd)		Rhinoplastic Hooks (cont'd)	
" Wieder	591	" Joseph	638
" Williger	312	" Neivert	637
" Young	869, 870	Rhinoplastic Instruments	633-644
" Zenker	322	" Joseph	642
Reverdin Needles	276-278	Rhinoplastic Measuring Device Joseph	640
" Albaran	277	Rhinoplastic Needles Yankauer	638
" Redon	278	Rhinoplastic Osteotomes	634, 635
" Tierny	278	" Cottle	634, 635
Reverdin Retractor	374	" Sheehan	635
Reverdin Spatulas	374	" Walter	634
Reynolds Scissors	47	Rhinoplastic Retractors	635, 637, 638
Reynolds-Jameson Scissors	47	" Aufricht	638
Rhinoplastic Chisel	633-636	" Cottle	635, 637
" Anderson-Neivert	636	" Converse	638
" Cinelli	636	" Freer	638
" Cottle	634	" Kilner	638
" Fomon	636	" Masing	637
" Freer	633	Rhinoplastic Rongeurs Kressner	642
" McIndoe	636	Rhinoplastic Saws	640, 642
" Metzbaum	633	" Cottle	642
" Moberg	636	" Joseph	640
" Neivert	636	" Mowlem	640
" Rubin	633, 636	Rhinoplastic Scissors	645, 646
" Silver	635	" Aufricht	646
" Swall	633	" Castanares	645
" Walter	634	" Cinelli	646
Rhinoplastic Files	639-641	" Converse	645
" Aufricht	639	" Cottle	645
" Converse	641	" Cottle (Bulldog)	645
" Cottle	639	" Fomon	646
" Fomon	641	" Heymann	646
" Gallaher	639-641	" Joseph	646
" Joseph	639, 640	" Littler	645
" Lewis	639	" McIndoe	645
" Maltz	639	" Seiler	646
" Masing	640	" Taylor	645
" Wiener	640	Rhinoplastic Sharp Curettes	647
Rhinoplastic Forceps	642-645	" Coakley	647
" Asch	642	" Dingman	647
" Cottle	644	" Faulkner	647
" Cottle-Masing	643	" Pratt	647
" Cottle-Walsham	643	Rib Shears	520-522
" Fox	644, 645	" Baer	522
" Guillen	644	" Bethune	522
" Hinderer	644	" Brunner	521
" Masing	644	" Collin	520
" Ogura	644	" Coryllos-Bethune (Collin)	522
" Rubin	642	" Giertz-Stille	521
" Tschoepe	643	" Gluck	520
" Walsham	643	" Lebsche	521, 522
" Walsham (Universal)	643	" Sauerbruch	521
Rhinoplastic Gouges	633	" Sauerbruch-Britsch	522
" Freer	633	" Sauerbruch-Frey	521
" Killian	633	" Schuchardt	521
" Killian-Claus	633	" Stille	520
Rhinoplastic Hammers	647	Rib Spreaders	524-535
" Cottle	647	" Ankeney	533
" Guillen	647	" Brasstad	532
" Quisling	647	" Burford	529
Rhinoplastic Hooks	637, 638	" Castaneda	532
" Cottle	637	" Cooley	524, 531
" Cottle-Neivert	637	" De Bakey	527, 528
" Fomon	637, 638	" Finochietto	526, 529-532
" Freer	638	" Finochietto-Baby-Haight	531

	Page		Page
Rib Spreaders (cont'd)		Rongeurs Bone (cont'd)	
" Finochietto-Infant	531	" Blumenthal	495
" Haight	525	" Bohler	497
" Hertzler	527	" Cleveland	494
" Lillianthal	533	" Cohen	491
" Mini Thoracotomy	532	" Cottle-Jansen	493
" Morse	524	" Echlin	499
" Nissen	528	" Fisch	492
" Quervain	533	" Freidmann	491
" Reinhoff-Finochietto	527	" Frykholm	499
" Sauerbruch	533	" Geiger	498
" Sellors	526	" Guleke	496
" Sick Children Hospital	525	" Hakansson	495
" Struch	525	" Jansen	493
" Tuffier	526	" Kleinert-Kutz	495, 498
Rib Spreaders and Contractors	535	" Leksell	500
" Bailey	535	" Lempert	494, 496
" Bailey-Baby	535	" Luer	492
" Crafoord	535	" Luer-Freidmann	491
" Lemmon	535	" Markwalder	502
" Rehbein (Mod. Bremen)	535	" Marquardt	497
" Sellors	535	" Mayfield	498
Ricard Retractor	403	" Mead	494, 495
Richardson Retractor	347, 348	" Mini-Freidmann	491
Richardson-Eastman Retractor	347	" Olivecrona	496
Richnau-Holmagren Ear Speculum	682	" Peiper-Beyer	498
Richter Operating Scissors	60	" Rottgen-Ruskin	497
Richter Retractor	397	" Ruskin	497
Richter Vaginal Retractors	942	" Ruskin-Mini	497
Ricord Rectal Specula	795	" Sauerbruch-Coryllos	502
Ring Cutters	519	" Sauerbruch-Stille	502
" Smith	519	" Schell	496
" Walton	519	" Semb	499
Rinne Needle Holders	255	" Smith-Petersen	500
Ritter-Halle Probes	653	" Stellbrink	491
Rntne Hospital Broncho-Esophagoscopy Forceps	601	" Stille	500
Robb Intima Spatula and Dilator	847	" Stille-Leksell	499
Robb Tonsil Knives	587	" Stille-Luer	501
Robb-Lewis Tonsil Retractors	591	" Stille-Ruskin	501
Roberts Haemostatic Forceps	174	" Sypert	501
Robertson Tonsil Knives	588	" Trotter	494
Roberts-Standard Trocars	230	" Universal	494
Robin Towel Forceps	212	" Zaufal	495
Robin-Masse Abdominal Retractor	404	" Zaufal-Jansen	498
Rochard Abdominal Retractor	414	Rongeurs	662-668
Rochers-Pean Haemostatic Forceps	168	" Caspar	664, 667, 668
Rochester Dressing Forceps	138	" Cloward	664
Rochester-Carmalt Haemostatic Forceps	174	" Cushing	663
Rochester-Mixter Bronchus and Gall Duct Clamps	187	" Ferris-Smith-Cushing	662
Roeder Ligature Carriers	590	" Kraemer	666
Roeder Towel Forceps	212	" Landolt	665
Roger Hysterectomy Atrauma Forceps	201	" Love-Gruenwald	663
Roger Septum and Periosteal Elevators	629	" Oldberg	664
Rogge Sterilizing Forceps	965	" Rhinoplastic Kressner	642
Rohrschneider Micro Needle Holders	271	" Schlesinger	664
Rolf Lachrymal Probes	719	" Spurling	663
Rollet Ophthalmic Chisels	710	" Sypert	666
Rollet Ophthalmic Retractors	713	" Wagner	665
Rollet Retractor	310	" Weil-Blakesley	663
Rongeurs Bone	491-502	" Yasargil	665
" Adson	496	Rooke Tissue Forceps	132
" Alexander	493	Roosevelt Intestinal and Stomach Clamp Forceps	782
" Bacon	494	Roschke Rectal Specula	795
" Bane	496	Rose Retractor	302, 376
" Beyer	492, 498	Rose Tracheal Retractors	609

	Page		Page
Rosen Dissectors	694	Sauerbruch Rib Shears	521
Rosen Ear Knives	688	Sauerbruch Rib Spreaders	533
Rosen Ear Needles	693	Sauerbruch Sterilizing Forceps	967
Roser Ear Loops	697	Sauerbruch-Britsch Rib Shears	522
Roser-Koenig Mouth Gags	562	Sauerbruch-Coryllos Bone Rongeurs	502
Ross Retractor	345	Sauerbruch-Frey Rib Shears	521
Rotter Tonsil Needles	593	Sauerbruch-Stille Bone Rongeurs	502
Rottgen-Ruskin Bone Rongeurs	497	Saupe Cilia Forceps	149
Round Bowls	982	Sautter Ophthalmic Orbit Spatulas	713
Round Dishes	983	Saws	115-119, 754
Rowe Disimpaction Forceps	585	" Gigli (Olivecrona)	119, 754
Rowe Retractor	338	Saws Rhinoplastic	640, 642
Rowe-Harrison Bone Holding Forceps	507	" Cottle	642
Rowland Ophthalmic Keratomes	707	" Joseph	640
Rowland Ophthalmic Knives	707	" Mowlem	640
Royce Paracentesis Needles	689, 690	Scalp Contour Retractor	383
Ruault Punch Forceps	597	Scalp Flap Forceps	951
Ruault-Collin Punch Forceps	597	" Gauss	951
Rubin Rhinoplastic Chisel	633, 636	" Green-Armytage	951
Rubin Rhinoplastic Forceps	642	" Willett	951
Rubman-Bores Ophthalmic Radial Keratomy Forceps	737	Scalpel Handles	20-23
Rudd Haemorrhoidal Ligators	803	Scalpels Operating	25-32
Rugby Haemostatic Forceps	178	Scarifying Knives	35
Rugby Retractor	389	" Maier	35
Ruhin Septum Scissors	632	" Nicaise	35
Rumel Dissecting and Ligature Forceps	182	" Ulrich	35
Rumel-Belmont Tourniquets	849	Schaaf Ophthalmic Strabismus Forceps	734
Ruskin Bone Rongeurs	497	Schaaf Splinter Forceps	146
Ruskin-Liston Bone Cutters	487	Schaedel Towel Forceps	214
Ruskin-Mini Bone Rongeurs	497	Schamberg Comedo Extractors	766
Ruskin-Rowland Bone Cutters	487	Schede Bone Curettes	477
Russian Model Tissue Forceps	138	Scheie Ophthalmic Knives	709
Rust Amputation Saws	118	Scheie-Westcott Ophthalmic Iridectomy Scissors	742
Rydel-Seiffer Tuning Forks	686	Scheinmann Cutting Forceps Tips	600
Ryder Needle Holders with T/C	262	Scheinmann Grasping Forceps Tips	600
Ryder-Vascular Needle Holders with T/C	262	Scheinmann Uterine Biopsy Forceps	896
		Schell Bone Rongeurs	496
		Schepens Lid Everters	704
S		Scherback Vaginal Speculum	929
Saalfeld Comedo Extractors	766	Scherback Weight for Vaginal Speculum	929
Sachse Genito-Urinary Forceps	876	Schimmelbusch Anaesthesia Mask	15
Saenger Placenta and Ovum Forceps	949	Schimmelbusch Sterilizing Boxes	976
Safar Ophthalmic Capsular Forceps	731	Schindler Peritoneal Clamp Forceps	206
Salenius Meniscectomy Knives	427	Schink Skin Grafting Knives	43
Samii Tumor Forceps	152	Schlesinger Punches	661
Samuel Vaginal Speculum	927	Schlesinger Rongeurs	664
Sanders-Brown Awls	586	Schmeden Nasal Cutting Forceps	623
Sarot Bronchus Forceps	536	Schmeden Punch Forceps	597
Sarot Dissecting and Ligature Forceps	183	Schmeiden Dick Ligature Needles	279
Sarot Needle Holders	244, 247	Schmid Vascular Spatulas	848
Sarot Needle Holders with T/C	260	Schmid Vessel Irrigating Cannulas	845
Saschs Dura Dissectors	757	Schmidt-Rimpler Ophthalmic Tissue Forceps	732
Saschs Dura Hooks	759	Schmieden Ligature Conductors	288
Satinsky Atrauma Cardiovascular Forceps	824	Schmieden Ligature Needles	279
Satinsky Vascular Scissors	73	Schmieden-Payr Ligature Conductors	288
Satinsky Vena Cava Clamps	852	Schmieden-Taylor Neurosurgical Scissors	78
Satinsky-De Bakey Atrauma Cardiovascular Forceps	824	Schmith-Green Ophthalmic Knives	706
Sato Ophthalmic Knives	708	Schnaudigl Ophthalmic Knives	708
Satterlee Amputation Saws	116	Schneider Pelvimeters	954
Sattler Ophthalmic Muscular Forceps	735	Schneider Raspatories	454
Sauer Eye Speculum	702	Schneider-Sauerbruch Raspatories	454
Sauer Ophthalmic Fixation Forceps	728	Schnidt Haemostatic Forceps	177
Sauer Retractor	380	Schnidt Tonsil Seizing Forceps	594
Sauerbruch Dressing and Cotton Swab Forceps	228	Schoemaker-Loth Ligature Scissors	53
Sauerbruch Retractor	328, 332, 358	Schoemaker-Loth Needle Holders	249

	Page		Page
Schoenborn Retractor	301	Scissors Delicate (cont'd)	
Schoenborn Tracheal Retractors	608	" Locklin	48
Scholle Stethoscope	8	" Maunoir	47
Schroeder Fistula Knives	33	" Micro Stevens	48
Schroeder Uterine Scoops	919	" Neumann	47
Schroeder Uterine Tenaculum Forceps	880, 882	" Quinby	47
Schroetter Tracheotomy Dilators	612	" Reynolds	47
Schubert Uterine Biopsy Forceps	891, 892	" Reynolds-Jameson	47
Schuchardt Rib Shears	521	" Stevens	45
Scudder Atrauma Intestinal and Stomach Clamp Forceps	787	" Wagner	47
Scudder Intestinal Clamp Forceps	777	" Wagner	52
Scudder Stomach Clamp Forceps	778	" Wire	50
Schuknecht Ear Knives	688	Scissors Dissecting	65-71
Schuknecht Ligature Scissors	54	" Fomon	65
Schuknecht Micro Wire Closure Forceps	678	" Gorney	65
Schulz Aortic Biptome	844	" Lexer-Baby (Knapp)	67
Schulz Retractor	342	" Lexer-Fino	67
Schulze-Bergmann Rectal Specula	796	" Littler	71
Schumacher Bone Levers	470	" Metzenbaum	71
Schumacher Cutting Forceps Tips	600	" Metzenbaum-Fino	65, 66
Schumacher Mod. Wagner Bone Levers	471	" Metzenbaum-Nelson	68-70
Schumacher Sternum Instruments	523	" Nerve-Preparation	65
Schumacher Umbilical Scissors	86, 953	" Ragnell	69
Schumacher Uterine Biopsy Forceps	892, 895, 896	" Thorek	71
Schumacher-Van Doren Uterine Biopsy Forceps	892	" Weller	68
Schumaker Atrauma Aortic Clamps	841	Scissors Episiotomy	85, 953
Schwartz Bone Gouges	433	" Braun-Stadler	85
Schwartz Micro Aneurysm and Vessel Clips	753	" Waldmann	85
Schwartz Bone Chisels	433	Scissors Gynecological	81-85
Schwarz Extension Bows	545	" Bozemann	83
Schwarz Nasal Speculum	613	" Doyen	82
Schweigger Discission Needles	711	" Dubois	83
Schweigger Ophthalmic Capsular Forceps	729	" Mayo-Noble	84
Schweizer Bandage Scissors	104	" Siebold	84
Scissors	44-108	" Sims	81-83
Scissors Bandage	104-107	" Sims-Siebold	82
" Bergmann	106	" Werthiem	81
" Braun-Stadler	107	Scissors Laryngeal	605, 606
" Bruns with T/C	103	Scissors Ligature	53-55
" Esmarch	106	" Beebee	55
" Knowles	105	" Buck	54
" Lange	104	" Eiselsboerg	53
" Lister	105-107	" Harvey	53
" Lister Excentric	106	" Heath	53
" Lister with T/C	103	" Littauer	54
" Lorenz	107	" Schoemaker-Loth	53
" Schweizer	104	" Schuknecht	54
" Smith	104	" Spencer	54
" Tornado	106	" Stitch	54
Scissors Broncho-Esophagoscopy	602, 603	Scissors Micro	738-743
Scissors Cloth	108	Scissors Micro Ear	676, 677
" Gauze	108	" Bellucci	676, 677
" Taylor	108	" Shea-Bellucci	677
Scissors Cuticle	127	" Wullstein	677
Scissors Delicate	44-52	Scissors Micro Yasargil	747, 748
" Chadwick	48	Scissors Nail	126, 127
" Dissecting	46	" Systrunk	518
" Enucleation	48	Scissors Nasal	618
" Goldman-Fox	45	" Boettcher	80
" Iris	44	" Cottle	79
" Jameson	47	" Dean	80
" Joseph	46	" Douglas	79
" Kelly	48	" Fomon	79
" Kilner	47, 49	" Good	80
" Knapp	51	" Heymann	79, 618

TABLE OF CONTENTS

	Page		Page
Scissors Nasal (cont'd)		Scissors Rhinoplastic (cont'd)	
" Jackson	618	" Cinelli	646
" Kirstein	618	" Converse	645
" Knight	618	" Cottle	645
" Knight	79	" Cottle (Bulldog)	645
" Prince	80	" Fomon	646
" Seiler	618	" Heymann	646
Scissors Neurosurgical	78	" Joseph	646
" Olivecrona	78	" Littler	645
" Schmieden-Taylor	78	" McIndoe	645
" Strully	78	" Seiler	646
" Toennis-Adson	78	" Taylor	645
Scissors Operating	56-64	Scissors Septum	632
" Busch	63	" Caplan	632
" Deaver	60	" Cottle	632
" Doyen	62	" Killian	632
" Dressing Flat Shanks	58	" Muhling	632
" Dressing Round Shanks	56, 57	" Ruhin	632
" Dressing Slim Pattern	59	Scissors Sternum	523
" Dublin	64	" Braun-Stadler	523
" Ferguson	61	" Potts	523
" Mayo	62	Scissors Suture	293, 294
" Mayo-Harrington	62	" Buck	294
" Mayo-Stille	61	" Kelly	294
" Mixter	64	" Locklin	294
" Nurses Flat Shanks	58	" O'Brien	294
" Nurses Round Shanks	56, 57	" Spencer	294
" Nurses Slim Pattern	59	" Spencer-Northbent	294
" Richter	60	" Universal	293
" Sharp/Probe	61	Scissors Tonsil	79, 80
" Standard Flat Shanks	58	" Boettcher	80
" Standard Round Shanks	56, 57	" Cottle	79
" Standard Slim Pattern	59	" Dean	80
" Systrunk	64	" Douglas	79
" Ward	64	" Fomon	79
" Werthiem	63	" Good	80
Scissors Ophthalmic	738-743	" Heymann	79
" Aebli	739	" Knight	79
" Barraquer	738	" Prince	80
" Castroviejo	739, 741, 742	Scissors Umbilical	86, 953
" Fine	741	" Mod. USA	86
" Katzin	739	" Schumacher	86
" Katzin-Barraquer	739	Scissors Vascular	72-77, 855
" LaGrange	743	" Church	76
" McClure	740, 743	" Crafoord	73
" McPherson-Vannas	741	" De Bakey	77, 855
" McPherson-Westcott	741	" Dietrich	74
" Micro	740	" Duffield	76
" Noyes	740, 742	" Favalaro	72
" Scheie-Westcott	742	" Jacobson	74
" Spencer	743	" Klinkenbergh-Loth	73
" Troutman	738	" Lincoln	76
" Troutman-Barraquer	739	" McIndoe	73
" Troutman-Castroviejo	738, 740	" Mills	75
" Vannas	741	" Potts-De Martel	75
" Vannas Mod. Tübingen	741	" Potts-Smith	72, 855
" Wecker	740	" Resano	77
" Westcott	741	" Satinsky	73
Scissors Rectal	801	" Strully	75
" Lloyd-Davis (Goligher's)	801	" Yasargil	74
" Miller	801	Scissors with Tungsten Carbide Inserts	87-103
" Stelzner	802	" Bandage	103
Scissors Rhinoplastic	645, 646	" Bruns Bandage	103
" Aufricht	646	" De Bakey	89
" Castanares	645	" Deaver	103

	Page		Page
Scissors with Tungsten Carbide Inserts (cont'd)		Screw Drivers (cont'd)	
" Dietrich	102	" Steinhauser	669
" Dressing	100, 101	Screw Holders	544
" Goldman-Fox	87	Searcy Ophthalmic Knives	709
" Iris	87	Sebileau Elevators	462
" Kelly	87	Secretion Curettes	876
" Lexer	90	Secretion Curettes Asch	876
" Lexer-Baby (Knapp)	89	Sedillot Raspatories	451
" Lister Bandage	103	Seemann-Seiffert (Seft-Retaining)	565
" Locklin	88	Seemann-Seiffert Mouth Gags	565
" Mayo	91	Segond Hysterectomy Forceps	196
" Mayo-Harrington	93	Segond Myomatome Knives	35
" Mayo-Lexer	90	Segond Myomatomes	899
" Mayo-Stille	92	Segond-Landau Hysterectomy Forceps	196
" Metzenbaum	94, 96	Seidl Uterine Biopsy Forceps	894
" Metzenbaum-Fino	95-99	Seidl Vaginal Retractors	938
" Metzenbaum-Lahey	96	Seidl Vaginal Speculum	938
" Metzenbaum-Thorek	97	Seiffert Grasping Forceps Tips	600
" Nurses	100, 101	Seiffert Suction Tubes	235, 240
" Parametrium	99	Seiler Nasal Scissors	618
" Potts-De Martel	102	Seiler Rhinoplastic Scissors	646
" Potts-Smith	88	Seldin Raspatories	454
" Ragnell (Kilner)	87	Select Dressing Forceps	131
" Sims	93, 101	Select Tissue Forceps	131
" Standard	100, 101	Self Centering Bone Holding Forceps	513
" Toennis-Adson	96	Selheim Obstetric Lever	955
" Universal	88	Sell Tubing Clamps	969
Scobee Muscle Hook	705	Sellors Rib Spreaders	526
Scoops Abortion	952	Sellors Rib Spreaders and Contractors	535
Scoops Exenteration Bunge	718	Semb Bone Cutters	490
Scoops Gall Stone	860	Semb Bone Holding Forceps	507
" Desjardins	861	Semb Bone Rongeurs	499
" Fergusson	860	Semb Bronchus Forceps	536
" Luer-Koerte	861	Semb Raspatories	455
" Mayo	860	Semb Retractor	333
" Mayo	862	Semken Dressing Forceps	133
" Moore	862	Semken Dressing Forceps with T/C	160
Scoops Micro Yasargil	750	Semken Tissue Forceps	133
Scoops Ophthalmic	715	Semken Tissue Forceps with T/C	160
" Art	715	Semm Vaginal Speculum	926
" Daviel	715	Senn-Green Retractor	308
" Elschmig	715	Senning Needle Holders	246
" Graefe	715	Senning Needle Holders with T/C	259
" Hess	715	Senn-Miller Retractor	308
" Knapp	715	Separators Neuro Woodson	762
" Lewis	715	Septum and Periosteal Elevators	627-631
" New Orleans	715	" Carter	629
" Snellen	715	" Converse	630
" Troutman	715	" Cottle	629, 630
" Verhoeff	715	" Freer-Ingals	628
" Weber	715	" Goldman	630
" Wells	715	" Hajek-Ballenger	628
Scoops Uterine	918, 919	" Halle	628
" Gourdet	919	" Howarth	629
" Schroeder	919	" Joseph	628
" Simon	918	" Joseph-Masing	630
Scoville Nerve Hooks	760	" Killian	628
Scoville Band Moving Curettes	761	" Kistner	628
Scoville Blades for Laminectomy Retractors	419	" Lange	630
Scoville Nerve Root Retractors	764	" Masing	629
Scoville-Richter Abdominal Retractor	409	" McKenty	628, 629
Scovilli-Haverfield Laminectomy Retractors	419	" Pennington	629
Screw Drivers	541-543	" Pierce	628
" Lane	542, 543	" Roger	629
" Phillips	542, 543	" Yankauer	630

TABLE OF CONTENTS

	Page		Page
Septum Compression Forceps	619-620	Simplex Tubing Clamps	969
Septum Elevators	627-630	Simpson Lachrymal Dilators	720
Septum Knives	628-627	Simpson Obstetrical Forceps	958, 963
" Ballenger	627	Simpson Uterine Sounds	900
" Flataue	626	Simpson-Braun Obstetrical Forceps	959
" Freer	627	Simpson-Luikart Obstetrical Forceps	959
" Freer-Ingals	627	Sims (Herrera) Uterine Curettes	911
" Joseph	625	Sims (Swiss Mod.) Uterine Sounds	900
" Killian	627	Sims Cotton Holders	901
" Maltz	626	Sims Gynecological Scissors	81-83
Septum Scissors	632	Sims Rectal Specula	796
" Caplan	632	Sims Scissors with T/C	93, 101
" Cottle	632	Sims Uterine Curettes	911, 915
" Killian	632	Sims Uterine Depressors	902
" Muhling	632	Sims Uterine Dilators	906
" Ruhin	632	Sims Uterine Sounds	900
Seutin Plaster Shears	110	Sims Vaginal Speculum	931
Sewall Raspatories	452	Sims-Maier Dressing and Sponge Holding Forceps	218
Sexton Paracentesis Needles	689-691	Sims-Siebold Gynecological Scissors	82
Sexton Retractor	393	Singley-Tuttle Grasping Forceps	141
Seyffert Vaginal Speculum	925	Siniscal-Smith Lid Everters	704
Shambaugh (Negus) Adenoid Curettes	652	Skeelee Chalazion Curettes	717
Shambaugh Adenoid Curettes	650	Skene Tissue Forceps	136
Shambaugh Ear Sounds	700	Skene Uterine Tenaculum Forceps	882
Shambaugh Retractor	381	Skillman Haemostatic Forceps	163
Shapleigh Ear Curettes	696	Skin Grafting Knives	43
Sharp Curettes Rhinoplastic	647	" Mayo	43
" Coakley	647	" Rehn	43
" Dingman	647	" Schink	43
" Faulkner	647	" Thiersch	43
" Pratt	647	Skinner Tissue Forceps with T/C	160
Shea Footplate Hand Instruments	695	Sluder-Ballenger Tonsillectomes	598
Shea-Bellucci Micro Ear Scissors	677	Smellie Decapitating Hooks	951
Sheehan Bone Gouges	435	Smellie Perforators	950
Sheehan Bone Osteotomes	438	Smillie Meniscectomy Knives	426
Sheehan Rhinoplastic Osteotomes	635	Smillie Retractor	336
Shepard Ophthalmic Capsular Forceps	731	Smith Bandage Scissors	104
Shuman Cheek and Lip Retractors	573	Smith Ophthalmic Hooklets	712
Sichel Ophthalmic Knives	708	Smith Ring Cutter	519
Sick Children Hospital Rib Spreaders	525	Smith-Buie Rectal Specula	797
Sicssors Gum	86	Smith-Fisher Double Instruments	724
" Locklin	86	Smith-Petersen Bone Gouges	442
" Nuemann	86	Smith-Petersen Bone Osteotomes	442
" Wagner	86	Smith-Petersen Bone Rongeurs	500
Siebenmann Cannula	653	Smithwick Nerve Hooks	759, 760
Siebold Gynecological Scissors	84	Snares Ear Polypus	671
Siegle Ear Speculum	683	" Krause	671
Sigmoid Anastomosis Atrauma Forceps	790-793	" Krause-Voss	671
" De Bakey (Morris Modif.)	793	" Lange-Wilde	671
" Fehland	792	Snares Nasal	618
" Glassman	790	" Krause	618
" Heyes	790	" Krause-Voss	618
" Kersting	791	" Lange-Wilde	618
" Morris	793	Snares Tonsil	596, 597
" Resano	792	" Brown	597
" Veidenheimer	791	" Bruenings	596
Silver Rhinoplastic Chisel	635	" Eves	596
Simon Amputation Knives	42	" Tyding	597
Simon Bone Curettes	481	Snellen Chalazion Forceps	737
Simon Fistula Hooks	902	Snellen Ophthalmic Scoops	715
Simon Fistula Knives	33	Snowden Stethoscope	6
Simon Operating Scalpel	31	Sofield Retractor	378
Simon Retractor	304, 335	Sokeland Catheter Introducing Forceps	865
Simon Uterine Scoops	918	Solution Bowls	982
Simon Vaginal Retractors	941	Somer Uterine Elevating Forceps	889

	Page		Page
Sonnenschein Nasal Speculum	614	Speculum Nasal (cont'd)	
Soonawala Vaginal Speculum	928	" Fraenkel	617, 618
Sounds Dilation Brock	850	" Hartmann	613
Sounds Ear Shambaugh	700	" Hartmann-Halle	613
Sounds Uterine	900	" Killian	615
" Collin	900	" Mod. Wein	613
" Emmet (Sims)	900	" Patton	617
" Mayo	900	" Schwarz	613
" Simpson	900	" Sonnenschein	614
" Sims	900	" Thudichum (Goldsmith)	617
" Sims (Swiss Mod.)	900	" Tieck-Halle	616
" Valleix	900	" USA Model	617
Southey Trocars	232	" Vienna	614
Spatulas	370-374, 714, 763, 847, 848	" Voltolini	617
" Allison	370	" Wiener Model	616, 617
" Castroviejo	714	" Yankauer	615
" Culler	714	Speculum Rectal	795-799
" Cushing	763	" Barr	797
" Dastoor	714	" Bensaude	798
" Haberer	374	" Brinkerhoff	797
" Halle	848	" Cook	795
" Heifetz	763	" Czerny	795
" Kader	372	" Hirschmann	798
" Kocher	374	" Ives-Fransle	798
" Koerte	371	" Kelly	799
" Kuemmel	371	" Killian	795
" Leriche	372	" Mathieu	795
" Mikulicz	373	" Newman	798
" Olivecrona	763	" Park	797
" Orbit Sautter	713	" Pratt	797
" Reverdin	374	" Ricord	795
" Robb	847	" Roschke	795
" Schmid	848	" Schulze-Bergmann	796
" Stock	714	" Sims	796
" Suker	714	" Smith-Buie	797
" Tuffier	374	Speculum Vaginal	920-941
" Weber	714	" Auvard	927
" Wecker	714	" Bozemann	930
Special Forceps	151, 152	" Braun	932
" Adson	152	" Breisky	931
" De Bakey	152	" Breisky (Wiener Model)	934
" Heifetz	151	" Collin	923-925
" Hunt	151	" Collin-Landau	925
" Samii	152	" Cusco	922, 923
" Tying	152	" Doyen	933
" Yasargil	151	" Dunkel	934
" Yasargil-Samii	151	" Eastman	931
Speculum Ear	680-683	" Fergusson	926
" Boucheron	680	" Grave Special	921
" Bruenings	682	" Graves	920, 921
" Erhardt	682	" Graves Modif.	920
" Gruber	681	" Guttman	926
" Hartmann	680	" Jackson	931
" Holmagren	682	" Kallmorgen	940
" Paparella	682	" Kristeller	932, 935-938
" Politzer	680	" Kristeller (Wiener Modl)	939
" Richnau-Holmgren	682	" Landau	934
" Siegle	683	" Mathieu	932
" Toynbee	680	" Matzenauer	934
" Troeltsch	681	" Nott	926
" Zoeliner	681	" O'Sullivan-O'Connor	941
Speculum Nasal	613-618	" Pederson	920
" Beckmann	614	" Samuel	927
" Cholewa	618	" Scherback	929
" Cottle	615, 616	" Seidl	938

	Page		Page
Speculum Vaginal (cont'd)			
" Semm	926	Stelzner Rectal Scissors	802
" Seyffert	925	Stephenson Ophthalmic Trephines	721
" Sims	931	Sterile Deposit System	975
" Soonawala	928	Sterilizing Boxes	976
" Trellet	923	Sterilizing Cases	970-974
" Weissbarth	928	Sterilizing Containers	980
Spencer Chalazion Forceps	738	Sterilizing Drums	977
Spencer Ligature Scissors	54	Sterilizing Forceps	965-968, 973
Spencer Ophthalmic Enucleation Scissors	743	" Cheattle	965, 966
Spencer Suture Scissors	294	" Collin	966
Spencer-Northbent Suture Scissors	294	" Davis	968
Spencer-Wells Artery Forceps	172, 173	" London-Hospital	965
Spencer-Wells Haemostatic Forceps	173	" Pye-Smith (Harrison)	966
Sphincteroscopes	798, 799	" Rogge	965
Splinter Forceps	144-148	" Sauerbruch	967
" Arthur	148	" Ulleval	965
" Carmalt	145	Sterilizing Racks	970
" Droeber	146	Sterilizing Jars	973, 977, 978
" Feilchenfeld	147	Sterilizing Trays	973
" Hunter	145, 146	Sternberg Cheek and Lip Retractors	572
" Peet	147	Sternberg Retractor	378
" Physician	148	Sternum Instruments	523
" Ralk	147	Sternum Retractors	523
" Ralk (Virtus)	147	" Oelert	523
" Schaaf	146	Sternum Scissors	523
" Stieglitz	148	" Braun-Stadler	523
" Stieglitz (Williams)	148	" Potts	523
" Vanguard	147	Stethoscopes	5-9
" Walter	145	" Anestophon	8
Spoons Gland Cushing	761	" Bowles	5
Sprague Paracentesis Needles	692	" Ford	5
Spratt Bone Curettes	478	" Harter (Stereo)	7
Spud Ophthalmic	710, 711	" Pinard	8
" Luer	710	" Reiger-Sprague	7
" Standard	710	" Scholle	8
Spurling Rongeurs	663	" Snowden	6
Sputum Cups	986	" Streamliner	6
St. Clair-Thomson Adenoid Curettes	649	" Triofon	7
St. Marks Modif. Girona Rectal Spreaders	799	Stetten Intestinal and Stomach Clamp Forceps	783
St. Marks Retractor	369	Stevens Micro Needle Holders	269
St. Vincent Tubing Clamps	209	Stevens Ophthalmic Hooklets	712
Stacke Hooklets	699	Stevens Ophthalmic Hooks	712
Stade-Moore Uterine Tenaculum Forceps	878	Stevens Ophthalmic Iris Forceps	725
Stamm Bone Cutters	486	Stevens Scissors	45
Standard Dressing Forceps	128-131, 138	Stevenson Eye Speculum	703
Standard Dressing Forceps with T/C	158	Stevenson Retractor	381
Standard Micro Aneurysm and Vessel Clips	753	Stieglitz (Williams) Splinter Forceps	148
Standard Scissors Round Shanks	56-58	Stieglitz Splinter Forceps	148
Standard Scissors Slim Pattern	59	Stienmann Drill Chuck	538
Standard Scissors with T/C	100, 101	Stille Bone Gouges	440
Standard Spud	710	Stille Bone Osteotomes	440
Standard Tubing Clamps	209	Stille Bone Rongeurs	500
Steinbach Mallet	423	Stille Chisels	440
Steinbach Needle Holders	255	Stille Dressing Forceps	132
Steinhauser Bone Holding Forceps	503	Stille Gall Stone Forceps	859
Steinhauser Drills	669	Stille Hand Drills	538
Steinhauser Forceps	669, 670	Stille Kidney Pedicle Clamps	190
Steinhauser Instruments	669, 670	Stille Ligature Conductors	288
Steinhauser Pliers	670	Stille Needle Holders	255
Steinhauser Retractors	669, 670	Stille Plaster Shears	109, 110
Steinhauser Screw Drivers	669	Stille Rib Shears	520
Steinmann Extension Bows	546	Stille Tissue Forceps	132
Steinmann Tendon Seizing Forceps	429	Stille Tongue Holding Forceps	579
Stellbrink Bone Rongeurs	491	Stille-Barraya Dissecting Forceps	771
		Stille-Barraya Tissue Forceps	134

	Page		Page
Stille-Leksell Bone Rongeurs	499	Suture Forceps (cont'd)	
Stille-Luer Bone Rongeurs	501	" Heath	293
Stille-Mini Plaster Shears	109	" Hegenbarth	292
Stille-Ruskin Bone Rongeurs	501	" Lange	292
Stille-Sherman Hand Drills	538	" Michel	292, 293
Stitch Ligature Scissors	54	" Michel Modif.	293
Stock Cyclodialysis Spatulas	714	" Ochsner	292
Stock Ophthalmic Capsular Forceps	729	" Wachenfeldt	292
Stockmann Penis Clamp	871	Suture Instruments	279-286, 291-297
Stomach Clamp Forceps	778-789	" Bozemann	291
" Moynihan	779	" Caspar	291
" Scudder	778	" Friedrich	291
Stone Intestinal and Stomach Clamp Forceps	784	" Henton	291
Stone Tissue Forceps	137	" La Force	291
Storing Cases	974	" Wiener Model	291
Storz Corneal Burs	722	Suture Scissors	293, 294
Straight Retractor	305	" Buck	294
Strandell-Stille Retractor	313	" Kelly	294
Strassburger Mod. Tissue Forceps	133	" Locklin	294
Strassmann Uterine Elevating Forceps	889	" O'Brien	294
Stratte Needle Holders	245	" Spencer	294
Stratte Needle Holders with T/C	263	" Spencer-Northbent	294
Strauss Hypodermic and Biopsy Needles	240	" Universal	293
Strauss Penis Clamp	872	Sven Hanssen Abscess Knives	34
Streamliner Stethoscope	6	Swab Holders for Rectum	806, 807
Struch Rib Spreaders	525	" Norwood	806, 807
Struempel Ear Polypus Forceps	673	Swab Holders Mod. Heidelberg	744
Stully Neurosurgical Scissors	78	Swall Rhinoplastic Chisel	633
Stully Vascular Scissors	75	Swiss Mod. Needle Holders	247
Stryker-Scholl Meniscectomy Knives	426	Swiss Mod. Ophthalmic Capsular Forceps	729
Stubbs Adenoid Curettes	651	Swiss Mod. Ophthalmic Needles	710
Stucker Gall Duct Dilators	863	Swiss Mod. Uterine Biopsy Forceps	896
Subramanian-Miniature Neonatal and Pediatric Clamps	837	Swiss Model Meniscectomy Knives	426
Suction Handles	237	Syme Ligature Needles	286
Suction Tubes	234-240, 807	Sypert Bone Curettes	483
" Adson	235	Sypert Bone Rongeurs	501
" Andrews-Pynchon	234	Sypert Punches	662
" Brand	807	Sypert Rongeurs	666
" Buie	807	Sypert Tampers	448
" Byrd	239	Systrunk Nail Scissors	518
" Cogswell	239	Systrunk Operating Scissors	64
" Cooley	236		
" Coupland	238	T	
" De Bakey	234, 235	Tabb Ear Knives	688
" Fergusson	235	Tager Bone Levers	470
" Frazier (Fergusson)	235	Takahashi Nasal Polypus Forceps	622
" Gomel	237	Tampers	448
" Gorney	239	" Caspar	448
" Hepp-Scheidel	237	" Haase	448
" Landolt	239	" Passow	448
" Lpez-Reinke	239	" Sypert	448
" Nuboer	238	Tapia Tongue Depressors	572
" Plester	236	Tarnier Basiotribes	957
" Pool	234	Tarnier Obstetrical Forceps	964
" Poppen	235	Taylor Blades for Laminectomy Retractors	419
" Seiffert	235, 240	Taylor Bone Levers	466
" Suction Handles	237	Taylor Cloth Scissors	108
" Wullstein	237	Taylor Dressing Forceps	135, 136
" Yankauer	234	Taylor Nerve Root Retractors	764
" Yasargil	240	Taylor Percussion Hammers	17
Suker Cyclodialysis Spatulas	714	Taylor Rhinoplastic Scissors	645
Suture Forceps	292, 293	Taylor Tissue Forceps	136
" Braith-Waite	293	Teale Uterine Tenaculum Forceps	885
" Child	292	Telescopic Hammers	16
" Collin	293		

	Page		Page
Temple Fay Abdominal Retractor	410	Tissue Forceps (cont'd)	
Temporomandibular Joint Instruments	584	" Adlerkreutz	136
Tendon Seizing Forceps	429-432	" Adson	139, 140
" Brand	429, 432	" Adson with T/C	158
" Caroll	432	" Adson-Brown	139, 140
" Herz	431	" Adson-Brown with T/C	158
" Jackson	432	" Adson-Graefe	140
" Jager	431	" Boney	131
" Kleinert-Kutz	431	" Bonney with T/C	160
" Steinmann	429	" Brophy	134
Tendon Seizing Instruments	429-432	" Brown	138
" Brand	430	" Buehressen	138
" Bunnell	429, 430	" Collin Duval	141
" Fischer	430	" Cushing	135
Tendon Tucker Bishop	723	" De Bakey with T/C	159
Tenotomes	29	" Durante	138
Terrier Haemostatic Forceps	165	" Duval	138
Terson Ophthalmic Capsular Forceps	729, 731	" Ferris-Smith	131
Tessier Bone Curettes	482	" Ferris-Smith with T/C	160
Tessier Maxillary Mobilizers	584	" Gerald	137
Thiersch Skin Grafting Knives	43	" Gillies	132
Thies Bone Gouges	437	" Gillies with T/C	159
Thilenius Tonsil Seizing Forceps	595	" Gruenwald	142
Thole Measuring Instrument	10	" Gruenwald (Jansen)	142
Thole Pelvimeters	955	" Hudson (Ewald)	139
Thomas Uterine Curettes	914	" Koenig	134
Thoms-Allis Tissue and Organ Holding Forceps	768	" Lane	137
Thomson-Walker Bladder Retractor	415	" Lexer	137
Thoms-Gaylor Uterine Biopsy Forceps	893	" Lucae	142
Thomson-Walker (Bozemann) Needle Holders	248	" Micro-Adson	139
Thorek Dissecting Scissors	71	" Micro-Adson-Biemer	140
Thorpe Chalazion Curettes	717	" Nelson	141
Thorpe Dressing Forceps	140	" Oehler with T/C	158
Thudichum (Goldsmith) Nasal Speculum	617	" Potts-Smith	135
Tieck-Halle Nasal Speculum	616	" Ramsay	132
Tiery Reverdin Needles	278	" Rooke	132
Tilley Nasal Polypus and Septum Forceps	620	" Russian Model	138
Tips for Cutting and Grasping Forceps	600	" Select	131, 132
Tischler Uterine Biopsy Forceps	894, 897, 898	" Semken	133
Tischler-Kevorkian Uterine Biopsy Forceps	897, 898	" Semken with T/C	160
Tischler-Morgan Uterine Biopsy Forceps	897, 898	" Skene	136
Tissue and Organ Holding Forceps	179, 180, 767-770	" Skinner with T/C	160
" Allis	767	" Stille	132
" Allis-Adair	767	" Stille-Barraya	134
" Allis-Babcock	769	" Stone	137
" Allis-Baby	767	" Strassburger Mod.	133
" Allis-Niro	768	" Taylor	136
" Babcock	769	" Treaves	133
" Babcock with T/C	770	" Troeltsch (Wilde)	143
" Babcock-Baby	769	" Waugh	134
" Boys-Allis	767	" Williams with T/C	159
" Chaput	179, 767	Tivnen-Tyding Tonsil Seizing Forceps	595
" Collin	179	Tobold Laryngeal Polypus Forceps	582
" Duval	769	Tobold Tongue Depressors	570, 571
" Duval with T/C	770	Toennis Dura Dissectors	757
" Duval-Collin	769	Toennis Dura Hooks	759
" Judd-Allis	768	Toennis Haemostatic Forceps	176
" Lane	769	Toennis Needle Holders	251
" Lockwood	768	Toennis Needle Holders with T/C	268
" Lockwood-Allis	768	Toennis Neuro Knives	762
" Lovelace	768	Toennis Retractor	304
" Thoms-Allis	768	Toennis Vascular Dissectors	848
" Tuffier	179, 767	Toennis-Adson Neurosurgical Scissors	78
" Williams	768	Toennis-Adson Scissors with T/C	96
Tissue Forceps	128-143	Tohoku Towel Forceps	212

TABLE OF CONTENTS

	Page		Page
Tongue Depressors	569-572	Tonsil Needles (cont'd)	
" Andrew	571	" Trelat	592
" Baginski	571	" Walker	593
" Bishop	572	Tonsil Retractors	591
" Bosworth	571	" Goodyear	591
" Bruenings	570	" Hofer	591
" Buchwald	569	" Lothrop	591
" Doyen	570	" Love	591
" Frenzel	570	" Neger	591
" Hartmann	570	" Robb-Lewis	591
" Le Mee	571	" Wieder	591
" Mayo	570	Tonsil Scissors	79, 80
" Moritz-Schmidt	572	Tonsil Seizing Forceps	594, 595
" Mulux	572	" Ballenger	594
" Tapia	572	" Blohmke	595
" Tobold	570, 571	" Colver	594
" University of Minnesota	572	" Leineweber	595
" Weder	571	" Marschik-Krone	594
Tongue Holding Forceps	578, 579	" McWorther-Lothrop	595
" Collin	578	" Muck	595
" Guy	578	" Museux	595
" Heywood-Smith	579	" Schnidt	594
" Heywood-Smith Modif.	579	" Thilenius	595
" Loebker	579	" Tivnen-Tyding	595
" Mathieu	579	" White	594
" Stille	579	Tonsil Snares	596, 597
" Young	579	" Brown	597
Tonsil Elevators	592	" Bruenings	596
" Alderdice	592	" Eves	596
" Hartmann	592	" Tyding	597
" Yankauer	592	Tonsillectomes	598
Tonsil Haemostats	596	" Baginsky	598
" Crown	596	" Mackenzie	598
" Vetter-Ulrich	596	" Sluder-Ballenger	598
Tonsil Knives	587-589	Took Ophthalmic Knives	709
" Abraham	587, 588	Tornado Bandage Scissors	106
" Brophy	588	Tourniquets Rumel-Belmont	849
" Bruenings	587	Towel Clamps	210-214
" Canfield	587	" Backhaus	211
" Carpenter	589	" Backhaus-Kocher	211
" Colver	588	" Bernhard	213
" Day	588	" Doyen	214
" Dean	589	" Engl. Model	214
" Douglas	588	" Hoff	211
" Fischer	588	" Jones	214
" Freer	588	" Lane	213
" Harris	589	" Lorna	212
" Lothrop	587	" Moynihan	213
" Lynch	587	" Ombredanne (Jackson)	212
" Milette	589	" Peers-Bertram	212
" Robb	587	" Robin	212
" Robertson	588	" Roeder	212
" Tyding	587	" Schaedel	214
" Whitehead	589	" Tohoku	212
Tonsil Needles	592-594	Toynbee Ear Speculum	680
" Alexander	594	Trabecular Probes	719
" Clas-Eicken	593	" Harms	719
" Dupuy-Weiss	592	" Mackensen	719
" Durham	593	Tracheal Dilators	607
" Eicken	593	" Laborde	607
" Falk	593	" Trousseau	607
" Henton	592	Tracheal Retractors	607-609
" Hurd	593	" Bose	608
" Nager	592	" Finsen	608
" Rotter	593	" Finsen Modif.	608

	Page		Page
Tracheal Retractors (cont'd)		Trocars (cont'd)	
" Iterson	607	" Southey	232
" Jackson	609	" Tracheal Uckermann	607
" Luer	609	" Universal	229
" Lukens	609	Troeltsch (Wilde) Dressing Forceps	143, 671
" Rose	609	Troeltsch (Wilde) Tissue Forceps	143
" Schoenborn	608	Troeltsch Dressing Forceps	143
" Weedra	607	Troeltsch Ear Catheters	671
Tracheal Trocars Uckermann	607	Troeltsch Ear Speculum	681
Tracheal Tubes	609-611	Troeltsch Hooklets	699
" Chevalier-Jackson	610	Troeltsch Nasal Polypus and Septum Forceps	620
" Collin	610	Troeltsch Paracentesis Needles	691
" Jackson	610	Troemner Percussion Hammer	19
" Krishaber	611	Troemner Simplex Percussion Hammer	19
" Krishaber-Luer	611	Trotter Bone Rongeurs	494
" Luer	611	Trousseau Tracheal Dilators	607
" Wagener-Mosher	609	Truthman-Rectus Ophthalmic Strabismus Forceps	734
Tracheotomy and Dilator Sets	612	Troutman (Colibri) Ophthalmic Fixation Forceps	727
Transplant Forceps	721	Troutman Chris Razor Blade Holder	24
" Berens	721	Troutman Ophthalmic Knives	710
" Paton	721	Troutman Ophthalmic Micro Scissors	738
Traube Percussion Hammer	18	Troutman Ophthalmic Scoops	715
Trautmann Bone Chisels	433	Troutman-Barraquer Ophthalmic Micro Scissors	739
Trays for Instruments	984, 985	Troutman-Castroviejo Ophthalmic Micro Scissors	738, 740
Trays for Sterilizing	973	Tschoepe Rhinoplastic Forceps	643
Trays for Tablets	983	Tubal Operation Instruments	899
Trays Kidney	987	Tubal Seizing Forceps	141, 899
Treaves Tissue Forceps	133	Tube Aortic Dilators	844
Trelat Ligature Needles	285	Tubes Interchangeable for Broncho-Esophagoscopy Forceps	599
Trelat Raspatories	451	Tubes Tracheal	609-611
Trelat Tonsil Needles	592	" Chevalier-Jackson	610
Trelet Vaginal Speculum	923	" Collin	610
Trephines	115, 721, 722	" Jackson	610
" Arruga	721	" Krishaber	611
" Castroviejo	721, 722	" Krishaber-Luer	611
" Elliot	721	" Luer	611
" Grieshaber	721	" Wagener-Mosher	609
" Stephenson	721	Tubing Clamps	209, 210, 969
Triangular Basin	987, 988	" Hoffmann	969
Trigeminal Knives	34	" Holt	969
Triofon Stethoscope	7	" Marcuse	210
Trocars	229-233	" Mod. Klinikum-Berlin	210
" Billroth	231	" Mohr	969
" Brich	232	" Sell	969
" Buelau	231	" Simplex	969
" Campbell	231	" St. Vincent	209
" Coakley	230	" Standard	209
" Curshmann	232	" Ulrich	969
" Douglas	231, 233	Tubingen Ophthalmic Strabismus Forceps	733
" Duke	232	Tubinger Mod. Retractor	386
" Emmet	231	Tubinger Model Vaginal Retractors	941
" Fleurant	233	Tubinger Modell Gall Stone Forceps	859
" Graefe-Standard	230	Tudor-Edwards Bone Cutters	490
" Haeggstroem	233	Tuffier Bone Holding Forceps	510
" Hagedorn	231	Tuffier Retractor	344, 374
" Krause	230	Tuffier Rib Spreaders	526
" Landau	229	Tuffier Spatulas	374
" Lichtwitz	230, 231	Tuffier Tissue and Organ Holding Forceps	179, 767
" Lower	232	Tumor Forceps	151, 152
" Nelson	232	Tuning Forks	683-687
" Nelson-Standard	230	" Alu	685, 687
" Ochsner	232	" French	685
" Pean	232	" Gardiner-Brown	686
" Pierce	230	" Hartmann	683, 684, 686, 687
" Roberts-Standard	230	" Koenig	686

	Page		Page
Tuning Forks (cont'd)		Uterine Biopsy Forceps (cont'd)	
" Lucae	684, 686	" Tischler	894, 897, 898
" Rydel-Seiffer	686	" Tischler-Kevorkian	897, 898
Tunneling Instruments	846	" Tischler-Morgan	897, 898
Turner-Warwick Gall Stone Forceps	860	" Van Doren	892, 893
Tyding Tonsil Knives	587	" Wittner	895
Tyding Tonsil Snares	597	Uterine Catheters	916
Tying Special Forceps	152	" Bozemann-Fritsch	916
Tyrel Ophthalmic Hooks	712	" Hildebrandt	916
 		Uterine Curettes	909-915
U		" Blake	914
U. S. Army Bone Chisels	439	" Bumm	912
U. S. Army Bone Gouges	439	" Collin	913
U. S. Army Bone Osteotomes	439	" Greene	912
Uckermann Tracheal Trocars	607	" Heaney	913
Uffenorde Bone Curettes	478	" J. O. M. W. Type	915
Ulleval Sterilizing Forceps	965	" Milan	913
Ulrich Bone Holding Forceps	512	" Recamier	909, 910
Ulrich Dressing and Cotton Swab Forceps	227, 228	" Sims	911, 915
Ulrich Fistula Knives	33	" Sims (Herrera)	911
Ulrich Scarifying Knives	35	" Thomas	914
Ulrich Tubing Clamps	969	" Wallich	913
Ulrich-St. Gallen Abdominal Retractor	409	" Zaufel (Blake)	914
Ultra-Micro Bulldog Clamps	208	Uterine Depressors	902
Umbilical Cord Clamps	953	" Braun	902
Umbilical Cord Clamps Collin	953	" Sims	902
Umbilical Cord Clamps Kane	953	Uterine Dilators	903-906
Umbilical Scissors	86, 953	" Goodell	906
Universal Bone Rongeurs	494	" Hank	905
Universal Diagnostic Set	13	" Hegar	903, 904
Universal Jugs	981	" Jolly	905
Universal Scissors with T/C	88	" Pratt	905
Universal Suture Scissors	293	" Sims	906
Universal Trays	984	" Wylie	906
Universal Trocars	229	Uterine Dressing Forceps	886
University of Minnesota Tongue Depressors	572	" Blumenthal	887
Unna Comedo Extractors	766	" Bozemann	886
Unna-Vidal Comedo Extractors	765	" Bozemann-Douglas	886
Ureter Atrauma Forceps	872	" Bumm	887
Urethrography Instruments	877	" Kelly	887
Urinary Pot	987	" Noto	887
Uro-Tangential Atrauma Forceps	203	" Pelkmann	886
USA Model Nasal Speculum	617	Uterine Elevating Forceps	888, 890
Uterine Biopsy Forceps	891-898	" Collin	888, 890
" Alexander	891	" Dartigues	890
" Appendorf	895, 898	" Somer	889
" Baby-Tischler	898	" Strassmann	889
" Burke	897, 898	Uterine Polypus and Ovum Forceps	887, 888
" Douay	896	" Doyen	888
" Faure	894	" Heywood-Smith	888
" Gaylor	893	Uterine Scoops	918, 919
" Gellhorn	893	" Gourdet	919
" Kevorkian	893, 898	" Schroeder	919
" Kevorkian-Pacific	897, 898	" Simon	918
" Krause	896	Uterine Sounds	900
" Medina	894	" Collin	900
" Mini-Townsend	898	" Emmet (Sims)	900
" Scheinmann	896	" Mayo	900
" Schubert	891, 892	" Simpson	900
" Schumacher	892, 895, 896	" Sims	900
" Schumacher-Van Doren	892	" Sims (Swiss Mod.)	900
" Seidl	894	" Valleix	900
" Swiss Mod.	896	Uterine Tenaculum Forceps	878-885
" Thoms-Gaylor	893	" Abel	881
		" Adair	878

	Page		Page
Uterine Tenaculum Forceps (cont'd)		Vaginal Speculum (cont'd)	
" Beacham	882	" Kristeller	932, 935-938
" Bernhard	878	" Kristeller (Wiener Modl)	939
" Berrett	878	" Landau	934
" Bovin	885	" Mathieu	932
" Braun	878, 879	" Matzenauer	934
" Collin-Pozzi	881	" Nott	926
" Czerny	879	" O'Sullivan-O'Connor	941
" Duplay	878	" Pederson	920
" Gordon	879	" Samuel	927
" H. G. Muller with T/C	884	" Scherback	929
" Henrotin	885	" Seidl	938
" Iowa	884	" Semm	926
" Jacobs	885	" Seyffert	925
" Jarcho	878	" Sims	931
" Kahn	882	" Soonawala	928
" Kustner	884	" Trelet	923
" Lahey	879	" Weissbarth	928
" Littlewood	885	Valleix Uterine Sounds	900
" Museux	879, 883, 884	Valvulotomes	851
" Museux-Palmer	884	" Bailey-Glover-O'Neil	851
" Pozzi	878, 881	" Brock	851
" Pozzi-Palmer	881	" Brock-Bailey	851
" Pratt	880	" Derra	851
" Schroeder	880, 882	" Dogliottie	851
" Skene	882	Van Alyea Catheters	652
" Stade-Moore	878	Van Buren Bone Holding Forceps	506
" Teale	885	Van Buren Dilators	874
Uterine Wash Curettes	916	Van Doren Uterine Biopsy Forceps	892, 893
		Vanaesectio Pocket Instrument Set	296
V		Vanguard Splinter Forceps	147
Vaginal Retractors	935-942	Vannas Mod. Tubingen Ophthalmic Micro Scissors	741
" Doyen	942	Vannas Ophthalmic Micro Scissors	741
" Gelpi	942	Varady Vascular Extractors	848
" Heaney	942	Vascular Dilators	845
" Joll (Friedman)	942	" De Bakey	845
" Kallmorgen	940	Vascular Dissectors	848
" Kristeller	935-938	" Davis	848
" Kristeller (Wiener Modl)	939	" Halle	848
" Landon	940	" Toennis	848
" Olshausen	942	Vascular Extractors Varady	848
" Richter	942	Vascular Measuring Device	841
" Seidl	938	Vascular Scissors	72-77, 855
" Simon	941	Vascular Spatulas	848
" Tubinger Model	941	" Halle	848
Vaginal Speculum	920-941	" Schmid	848
" Auvar	927	Vaughan Abscess Knives	34
" Bozemann	930	Veidenheimer Atrauma Sigmoid Anastomosis Forceps	791
" Braun	932	Vena Cava Clamps	852, 853
" Breisky	931	" Baby-Satinsky	852
" Breisky (Wiener Model)	934	" Harken	853
" Collin	923-925	" Hopfner	852
" Collin-Landau	925	" Potts-Satinsky	852
" Cusco	922, 923	" Satinsky	852
" Doyen	933	Venenhaken Brom Retractor	313
" Dunkel	934	Verbrugge Bone Holding Forceps	512, 515
" Eastman	931	Verhoeff Ophthalmic Fixation Forceps	729
" Fergusson	926	Verhoeff Ophthalmic Scoops	715
" Grave Special	921	Vernon Percussion Hammer	17
" Graves	920, 921	Vessel Clamps	854, 855
" Graves Modif.	920	" Derra	854
" Guttman	926	" Johns-Hopkins	854
" Jackson	931	" Potts	854, 855
" Kallmorgen	940	" Potts-Glover	854
		" Potts-Satinsky	855

	Page		Page
Vessel Forceps	151, 152	Weber Atrauma Cardiovascular Forceps	828
Vessel Irrigating Cannulas	845	Weber Cyclodialysis Spatulas	714
Vessel Irrigating Cannulas Cooley	845	Weber Ophthalmic Knives	708
Vessel Irrigating Cannulas Schmid	845	Weber Ophthalmic Scoops	715
Vetter-Ulrich Tonsil Haemostats	596	Webster Needle Holders	241
Vidal Lucas Curettes	765	Webster Needle Holders with T/C	258
Vienna Nasal Speculum	614	Wecker Cyclodialysis Spatulas	714
Virchow Anatomy and Post Mortem Knives	37, 38, 40	Wecker Ophthalmic Micro Scissors	740
Virchow Bone Osteotomes	441	Weder Tongue Depressors	571
Vogal Dilatation Forceps	229	Weedra Tracheal Retractors	607
Vogal Adenoid Curettes	649	Weeker Ophthalmic Keratomes	707
Volkmann Bone Curettes	476, 477, 479-481	Weeker Ophthalmic Knives	707, 709
Volkmann Retractor	311, 314-317	Weil Nasal Polypus Forceps	622
Voltolini Nasal Speculum	617	Weil-Blakesley Rongeurs	663
		Weinberg Retractor	359
		Weiner Ophthalmic Keratomes	707
		Weiner Ophthalmic Knives	707
		Weis Chalazion Forceps	738
		Weiss Amputation Saws	116
		Weiss Eye Speculum	702
		Weissbarth Vaginal Speculum	928
		Weitlaner Retractor	383-385
		Weitlaner-Baby Retractor	382
		Weitlaner-Beckmann Retractor	389
		Weitlaner-Loktite Retractor	382
		Weitlaner-Original Retractor	383
		Weitlaner-Wulstein Retractor	382
		Weller Dissecting Scissors	68
		Weller Meniscectomy Forceps	428
		Wells Ophthalmic Scoops	715
		Werthiem Hysterectomy and Vaginal Atrauma Forceps	202, 203
		Werthiem Hysterectomy and Vaginal Forceps	197-200
		Werthiem Hysterectomy Forceps	195-200
		Werthiem Kidney Pedicle Clamp Atrauma Forceps	868
		Werthiem Kidney Pedicle Clamp Forceps	868
		Werthiem Needle Holders	245, 248
		Werthiem Needle Holders with T/C	263
		Werthiem Operating Scissors	63
		Werthiem-Cullen Hysterectomy and Vaginal Forceps	199
		Werthiem-Cullen Kidney Pedicle Clamp Forceps	868
		Werthiem Atrauma Cardiovascular Forceps	837
		Werthiem Gynecological Scissors	81
		West Bone Gouges	435
		West Lachrymal Sac Chisels	723
		West Lachrymal Sac Gouges	723
		Westcott Ophthalmic Tenotomy Scissors	741
		Westermarck Dressing and Washing Forceps	226
		Westmacott Nasal Polypus and Septum Forceps	619
		Wheeler Double Instruments	724
		Wheeler Ophthalmic Knives	706
		White Tonsil Seizing Forceps	594
		Whitehead Mouth Gags	565
		Whitehead Tonsil Knives	589
		Wickstrom Bronchus and Gall Duct Clamps	187
		Wieder Tonsil Retractors	591
		Wiener Model Hysterectomy Forceps	193
		Wiener Model Nasal Speculum	616, 617
		Wiener Model Suture Instruments	291
		Wiener Ophthalmic Hooks	712
		Wiener Rhinoplastic Files	640
		Wigmore Plaster Lifter	115
		Wilberg Fracture Pins	545
		Wilde Dressing Forceps	143
		Wilder Lachrymal Dilators	720
		Willard-Colibri Ophthalmic Fixation Forceps	729

W

Wachenfeldt Suture Forceps	292
Wadsworth-Todd Cauterises	714
Wagener Nasal Cutting Forceps	624
Wagener-Mosher Tracheal Tubes	609
Wagner Bone Gouges	446
Wagner Bone Levers	468, 472
Wagner Gum Scissors	86
Wagner Mallet	424
Wagner Meniscectomy Knives	427
Wagner Needle Holders	257
Wagner Raspatories	459
Wagner Retractor	307
Wagner Rongeurs	665
Wagner Scissors	47, 52
Wagner-Jansen Retractor	381
Walb Anatomy and Post Mortem Knives	40
Waldau Ophthalmic Fixation Forceps	729
Waldenstrom Laryngeal Polypus Forceps	582
Waldmann Episiotomy Scissors	85
Walker Tonsil Needles	593
Walker-Lee Ophthalmic Knives	709
Wallich Uterine Curettes	913
Walsham (Universal) Rhinoplastic Forceps	643
Walsham Rhinoplastic Forceps	643
Walter Bone Gouges	441
Walter Rhinoplastic Chisel	634
Walter Rhinoplastic Osteotomes	634
Walter Splinter Forceps	145
Walton (Todd) Ophthalmic Gouges	710
Walton Ophthalmic Gouges	710
Walton Plaster Spreaders	113
Walton Ring Cutter	519
Walzl Hysterectomy Forceps	193
Wangensteen Dissecting Forceps	771
Wangensteen Dressing Forceps	134
Wangensteen Dressing Forceps with T/C	160
Wangensteen Needle Holders	247
Wangensteen Needle Holders with T/C	264
Ward Operating Scissors	64
Wartenberg Aesthesiometer	11
Wash Bowls	982
Wassmund Retractor	320
Waste Bucket	988
Watson-Williams Nasal Polypus Forceps	622
Waugh Dressing Forceps	134
Waugh Tissue Forceps	134
Weaver Chalazion Forceps	738
Weber Aesthesiometer	11

	Page		Page
Willet-Martel Haemostatic Forceps	176	Yasargil Micro Probes	750
Willet Scalp Flap Forceps	951	Yasargil Micro Raspatories	750
Williams Lung Grasping Forceps	537	Yasargil Micro Scoops	750
Williams Tissue and Organ Holding Forceps	768	Yasargil Rongeurs	665
Williams Tissue Forceps with T/C	159	Yasargil Special Forceps	151
Williger Bone Curettes	476, 479	Yasargil Suction Tubes	240
Williger Elevators	461	Yasargil Tumor and Vessel Forceps	151
Williger Mallet	420	Yasargil Vascular Scissors	74
Williger Raspatories	450	Yasargil-Samii Tumor Forceps	151
Williger Retractor	312	Yeoman Biopsy Forceps for Rectum	804
Wills-Hospital Cauteries	714	Yeoman Handle Broncho-Esophagoscopy Forceps	599
Wilmer-Bagley Ophthalmic Lens Expressors	713	Young Genito-Urinary Retractors	871
Winkelmann Circumcision Clamps	877	Young Ligature Needles	279
Winter Placenta and Ovum Forceps	944-948	Young Prostatic Lobe Forceps	872
Wire Closure Forceps Micro	678, 679	Young Prostatic Retractors	869, 870
" Greven	678	Young Tongue Holding Forceps	579
" Juers	678	Young-Hryntschan Ligature Needles	279
" McGee	678		
" Schuknecht	678		
Wire Cutting Pliers	552-555	Z	
" Angle	552	Zaufal Bone Rongeurs	495
" Reill	553	Zaufal Foreign Body Instruments	698
" with T/C	554, 555	Zaufal-Jansen Bone Rongeurs	498
Wire Saws Gigli (Olivecrona)	119, 754	Zaufal (Blake) Uterine Curettes	914
Wire Scissors	50, 51, 55	Zenker Dissecting and Ligature Forceps	184
Wittner Uterine Biopsy Forceps	895	Zenker Retractor	322
Wolf Ear Curettes	697	Ziegler Cilia Forceps	149
Wolf Lucas Curettes	765	Ziegler Eye Speculum	702
Wolf Plaster Breakers	112	Ziegler Head Bands	3
Woodruff Ligature Needles	744	Ziegler Head Mirrors	2,3
Woodson Neuro Separators	762	Ziegler Lachrymal Dilators	721
Worth Ophthalmic Advancement Forceps	736	Ziegler Lachrymal Probes	719
Wright (Derf) Needle Holders with T/C	258	Ziegler Ophthalmic Knives	708
Wrigley Obstetrical Forceps	958	Ziegler-Renova Head Bands	3
Wullstein Ear Knives	688	Ziegler-Renova Head Mirrors	1
Wullstein Hooklets	699	Zielke Bone Gouges	446
Wullstein Micro Ear Scissors	677	Zoeliner Ear Speculum	681
Wullstein Micro Malleus Nippers	679	Zweifel Compression Forceps	200
Wullstein Suction Tubes	237	Zweifel Needle Holders	253
Wullstein-Blakesley Micro Ear Forceps	675	Zweifel Needle Holders with T/C	267
Wylie Uterine Dilators	906		
 X			
 Y			
Yankauer Anaesthesia Mask	15		
Yankauer Ear Curettes	697		
Yankauer Hooklets	699		
Yankauer Ligature Needles	284		
Yankauer Nasal Speculum	615		
Yankauer Rhinoplastic Needles	638		
Yankauer Septum and Periosteal Elevators	630		
Yankauer Suction Tubes	234		
Yankauer Tonsil Elevators	592		
Yankauer-Jansen Hooklets	699		
Yasargil Galea Hooks	756		
Yasargil Micro Aneurysm and Vessel Clips	753		
Yasargil Micro Forceps	153, 157		
Yasargil Micro Ligature Guides	750		
Yasargil Micro Needle Holders	275		
Yasargil Micro Neuro Knives	749		
Yasargil Micro Neuro Scissors	747, 748		